

KORG

NAUTILUS

MUSIC WORKSTATION

Parameter Guide

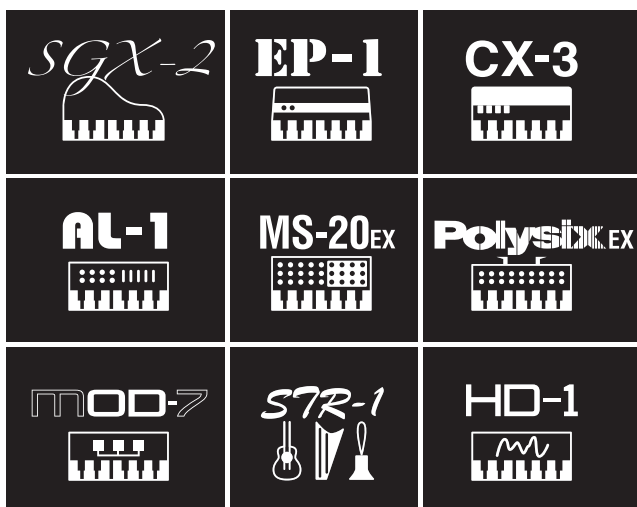

MS
Multi-Dimensional
Synthesis

SST
Smooth Sound
Transitions

CMT

REMS

TouchView
Graphical User Interface

GENERAL
MI

Thank you for purchasing the Korg NAUTILUS. To help you get the most out of your new instrument, please read this manual carefully.

About this manual

The owner's manuals and how to use them

These manuals apply to all NAUTILUS models. The front panel and rear panel illustrations show the NAUTILUS-61, but they apply identically to the other models.

The NAUTILUS comes with the following manuals.

- Quick Start Guide (printed and PDF)
- Operation Guide (PDF)
- Parameter Guide (PDF)
- Voice Name List (PDF)

A printed copy is included only for the Quick Start Guide.

You can download these PDF manuals from the Korg website (www.korg.com).

Quick Start Guide

Please read this first. It introduces all of the basic features of the NAUTILUS, and is designed to get you up and running quickly.

Operation Guide

Put simply, the Operation Guide is designed to answer the question, "How do I do this?"

It explains the names and functions of each part of the NAUTILUS, basic operation, an overview of each mode, how to edit sounds, record on the sequencer, sample, and so on. This guide also explains the basics of effects, arpeggiator, Wave Sequences, and Drum Kits.

Finally, it also contains a troubleshooting guide and supplemental information such as specifications.

Parameter Guide (this document)

The Parameter Guide is designed to answer the question, "What does this do?"

Organized by mode and page, the Parameter Guide includes information on each and every parameter in the NAUTILUS.

Voice Name List

The Voice Name List lists all of the sounds and setups that are in the NAUTILUS when it is shipped from the factory, including Programs, Combinations, Multisamples, Drumsamples, Drum Kits, Arpeggio Pattern, Wave Sequences, Drum Track Patterns, Template Songs, and Effect Presets.

PDF versions

The NAUTILUS PDF manuals are designed for easy navigation and searching. They include extensive PDF contents information, which generally appears on the side of the window in your PDF reader and lets you jump quickly to a specific section. All cross-references are hyper-links, so that clicking on them automatically takes you to the source of the reference.

Conventions in this manual

Abbreviations for the manuals: QSG, OG, PG, VNL

In the documentation, references to the manuals are abbreviated as follows.

QSG: Quick Start Guide

OG: Operation Guide

PG: Parameter Guide

VNL: Voice Name List

Symbols , , Note, Tips

These symbols respectively indicate a caution, a MIDI-related explanation, a supplementary note, or a tip.

Example screen displays

The parameter values shown in the example screens of this manual are only for explanatory purposes, and may not necessarily match the values that appear in the LCD screen of your instrument.

MIDI-related explanations

CC# is an abbreviation for Control Change Number.

In explanations of MIDI messages, numbers in square brackets [] always indicate hexadecimal numbers.

* Linux is a trademark or registered trademark of Linus Torvalds in the United States and in other countries.

* All product names and company names are the trademarks or registered trademarks of their respective owners.

Contents

About this manual ii

PROGRAM mode: HD-1 1

HD-1 Overview 1

PROGRAM > Home 2

- 0-1: Overview 2
- Program Select menu 5
- Quick Layer 8
- Quick Split 11
- 0-2: Performance Meter 13
- 0-6: ARP DRUM 15
- 0-8: Sampling 22
- 0-9: Tone Adjust 29

PROGRAM > Basic/X-Y/Controllers 35

- 1-1: Program Basic 35
- 1-5: X-Y Control 41
- 1-6: X-Y Envelope 45
- 1-8: Controllers 48

PROGRAM > OSC/Pitch 50

- 2-1: OSC1 Basic 50
- 2-2: OSC1 Pitch 55
- 2-5: OSC2 Basic 57
- 2-6: OSC2 Pitch 57
- 2-9: Pitch EG 58

PROGRAM > Filter 62

- 3-1: Filter1 62
- 3-2: Filter1 Mod. 65
- 3-3: Filter1 LFO Mod. 69
- 3-4: Filter1 EG 70
- 3-5: Filter2 73
- 3-6: Filter2 Mod. 73
- 3-7: Filter2 LFO Mod. 73
- 3-8: Filter2 EG 73

PROGRAM > Amp/EQ 74

- 4-1: Amp1/Driver1 74
- 4-2: Amp1 Mod. 76
- 4-3: Amp1 EG 79
- 4-5: Amp2/Driver2 81
- 4-6: Amp2 Mod. 82
- 4-7: Amp2 EG 82
- 4-9: EQ 82

PROGRAM > LFO 83

- 5-1: OSC1 LFO1 83
- 5-2: OSC1 LFO2 86
- 5-5: OSC2 LFO1 86
- 5-6: OSC2 LFO2 86
- 5-9: Common LFO 87

PROGRAM > AMS Mixer/Common KeyTrack ... 89

- 6-1: OSC 1 AMS Mix 89
- 6-5: OSC 2 AMS Mixer 95
- 6-9: Common KeyTrack 96

PROGRAM > IFX 98

- 8-1: Routing 98

8-5: Insert FX 101

8-7: IFX 1-12 103

8-9: Common FX LFO 105

PROGRAM > MFX/TFX 107

- 9-1: Routing 107
- 9-2: MFX1 109
- 9-3: MFX2 110
- 9-4: TFX1 110
- 9-5: TFX2 110

HD-1: Tone Adjust 111

PROGRAM: Page Menu Commands 112

PROGRAM mode: EXi 127

EXi PROGRAM > Home 127

- 0-1: Overview 128
- 0-2: Performance Meter 129
- 0-6: ARP DRUM 129
- 0-7: Sampling 129
- 0-8: Tone Adjust 129

EXi PROGRAM > Basic/X-Y/Controllers 130

- 4-1: Program Basic 130
- 4-2: EXi Audio Input 134
- 4-5: X-Y Control 135
- 4-6: X-Y Envelope 135
- 4-8: Controllers 135

EXi PROGRAM > Modulation 136

- 5-1: Common Step Seq 136
- 5-2: Common LFO 139
- 5-3: Common Keyboard Track 139

EXi PROGRAM > EQ 139

EXi PROGRAM > IFX 139

EXi PROGRAM > MFX/TFX 139

EXi PROGRAM: Page Menu Commands 140

EXi: AL-1 Analog Synthesizer 141

AL-1 Overview 141

EXi PROGRAM > Home 142

- 0-1: Overview 142

PROGRAM > AL-1: OSC/Pitch 144

- 4-1: OSC Basic 144
- 4-2: OSC Sub 147
- 4-3: Mixer 148
- 4-4: Pitch Common 150
- 4-5: Pitch EG/Mod. 152

PROGRAM > AL-1: Filter 154

- 5-1: Basic 154
- 5-2: Multi Filter 157
- 5-3: Filter Mod. 158
- 5-4: Filter LFO Mod. 161

| | |
|--|------------|
| PROGRAM > AL-1: Amp | 162 |
| 6-1: Amp/Driver | 162 |
| 6-2: Amp Mod. | 164 |
| 6-3: Amp EG | 166 |
| PROGRAM > AL-1: EG 1-4 | 169 |
| 7-1: EG 1 (Filter) | 169 |
| 7-2: EG 2 (Pitch) | 172 |
| 7-3: EG 3 | 172 |
| 7-4: EG 4 | 172 |
| PROGRAM > AL-1: Step Seq/LFO | 173 |
| 8-1: Step Sequencer | 173 |
| 8-2: LFO 1 | 175 |
| 8-3: LFO 2 | 178 |
| 8-4: LFO 3 | 178 |
| 8-5: LFO 4 | 178 |
| PROGRAM > AL-1: AMS Mixer | 179 |
| 9-1: AMS Mixer | 179 |
| AL-1: Tone Adjust | 180 |
| EXi AL-1: Page Menu Commands | 182 |

EXi: CX-3 Tonewheel Organ

| | |
|--|------------|
| CX-3 Overview | 183 |
| EXi PROGRAM > CX-3: Play | 184 |
| 0-1: Overview | 184 |
| PROGRAM > CX-3: Basic | 186 |
| 4-1: Basic | 186 |
| 4-2: Controllers | 188 |
| PROGRAM > CX-3: Split & Drawbars | 190 |
| 5-1: Keyboard Split | 190 |
| 5-2: Drawbars | 191 |
| 5-3: EX Drawbars | 192 |
| PROGRAM > CX-3: Percussion | 194 |
| 6-1: Percussion | 194 |
| 6-2: EX Percussion | 196 |
| PROGRAM > CX-3: Amp, V/C, Rotary Speaker | 197 |
| 7-1: Amp/V/C | 197 |
| 7-2: Rotary Speaker | 199 |
| PROGRAM > CX-3: AMS Mixer | 202 |
| 9-1: AMS Mixer | 202 |
| CX-3: Tone Adjust | 203 |
| Changes from the original CX-3 | 205 |
| EXi CX-3: Page Menu Commands | 206 |

EXi: STR-1 Plucked String

| | |
|---|------------|
| STR-1 Overview | 207 |
| EXi PROGRAM > STR-1: Home | 209 |
| 0-1: Overview | 209 |
| PROGRAM > STR-1: String | 211 |
| 4-1: Pluck/Noise | 211 |
| 4-2: PCM OSC | 213 |
| 4-3: PCM OSC Pitch | 216 |
| 4-4: Excitation Mixer | 219 |

| | |
|-------------------------------|-----|
| 4-5: String Main | 221 |
| 4-6: Damping/Dispersion | 225 |
| 4-7: String Pitch | 227 |
| 4-8: Pickups/Feedback | 230 |
| 4-9: Mixer | 232 |

PROGRAM > STR-1: Filter

| | |
|---------------------------|-----|
| 5-1: Basic | 234 |
| 5-2: Multi Filter | 237 |
| 5-3: Filter Mod. | 239 |
| 5-4: Filter LFO Mod. | 241 |

PROGRAM > STR-1: Amp

| | |
|--------------------|-----|
| 6-1: Amp | 242 |
| 6-2: Amp Mod. | 243 |
| 6-3: Amp EG | 245 |

PROGRAM > STR-1: EG 1-4

| | |
|--------------------------|-----|
| 7-1: EG 1 (Filter) | 248 |
| 7-2: EG 2 (Pitch) | 248 |
| 7-3: EG 3 | 248 |
| 7-4: EG 4 | 248 |

PROGRAM > STR-1: LFO 1-4

| | |
|------------------|-----|
| 8-1: LFO 1 | 248 |
| 8-2: LFO 2 | 248 |
| 8-3: LFO 3 | 248 |
| 8-4: LFO 4 | 248 |

PROGRAM > STR-1: AMS Mixers/

String Track

| | |
|---------------------------|-----|
| 9-1: AMS Mixers 1/2 | 249 |
| 9-2: AMS Mixers 3/4 | 249 |
| 9-9: String Track | 249 |

STR-1: Tone Adjust

EXi STR-1: Page Menu Commands

EXi: MS-20EX

MS-20EX Overview

| | |
|--|-----|
| On-screen knobs and switches and the Parameter Details area | 256 |
|--|-----|

EXi PROGRAM > MS-20EX: Home

| | |
|---------------------|-----|
| 0-1: Overview | 257 |
|---------------------|-----|

PROGRAM > MS-20EX: Oscillators & Filters ...

| | |
|----------------------------------|-----|
| 4-1: Oscillators & Filters | 259 |
|----------------------------------|-----|

PROGRAM > MS-20EX: MG, EG, and Modulation

| | |
|-----------------------------------|-----|
| 5-1: MG, EG, and Modulation | 263 |
|-----------------------------------|-----|

PROGRAM > MS-20EX: Patch Panel

| | |
|------------------------|-----|
| 6-1: Patch Panel | 267 |
|------------------------|-----|

PROGRAM > MS-20EX: EG

| | |
|-----------------|-----|
| 7-1: EG 3 | 277 |
| 7-2: EG 4 | 277 |
| 7-3: EG 5 | 277 |
| 7-4: EG 6 | 277 |

PROGRAM > MS-20EX: LFO

| | |
|------------------|-----|
| 8-1: LFO 1 | 277 |
| 8-2: LFO 2 | 277 |
| 8-3: LFO 3 | 277 |
| 8-4: LFO 4 | 277 |

| | |
|---|------------|
| PROGRAM > MS-20EX: AMS Mixers | 278 |
| 9-1: AMS Mixers 1/2 | 278 |
| 9-2: AMS Mixers 3/4 | 278 |
| MS-20EX: Tone Adjust | 279 |
| EXi MS-20: Page Menu Commands | 282 |
| <hr/> | |
| EXi: PolysixEX | 283 |
| PolysixEX Overview | 283 |
| On-screen knobs and switches and the Parameter Details area | 284 |
| EXi PROGRAM > PolysixEX: Home | 285 |
| 0-1: Overview | 285 |
| PROGRAM > PolysixEX: Main | 287 |
| 4-1: Patch Panel | 287 |
| PROGRAM > PolysixEX: Modulation & Arpeggiator | 291 |
| 5-1: Mod & Arp | 291 |
| PROGRAM > PolysixEX: EG | 293 |
| 7-1: EG 2 | 293 |
| 7-2: EG 3 | 293 |
| PROGRAM > PolysixEX: LFO | 293 |
| 8-1: LFO 1 | 293 |
| 8-2: LFO 2 | 293 |
| PROGRAM > PolysixEX: AMS Mixers | 293 |
| 9-1: AMS Mixers 1/2 | 293 |
| 9-2: AMS Mixers 3/4 | 293 |
| PolysixEX: Tone Adjust | 294 |
| EXi PolysixEX: Page Menu Commands | 296 |
| <hr/> | |
| EXi: MOD-7 Waveshaping VPM Synthesizer | 297 |
| MOD-7 Overview | 297 |
| Using the Parameter Details area | 299 |
| Loading DX sounds | 300 |
| Synthesis with the MOD-7: a guided tour | 301 |
| Overview | 301 |
| Individual oscillators and subtractive synthesis | 302 |
| VPM (aka FM) | 303 |
| Filtered VPM | 305 |
| PCM as a VPM modulator | 306 |
| Waveshaping | 306 |
| Ring Modulation | 309 |
| EXi PROGRAM > MOD-7: Home | 310 |
| 0-1: Overview | 310 |
| PROGRAM > MOD-7: Patch Panel | 312 |
| 4-1: Patch Panel | 312 |
| PROGRAM > MOD-7: Oscillator | 316 |
| 5-1: Osc Main | 316 |
| 5-2: PCM Osc | 320 |
| 5-3: PCM Mod | 322 |
| 5-4: VPM Osc 1 | 325 |
| 5-5: VPM Osc 2 | 335 |

| | |
|--|------------|
| 5-6: VPM Osc 3 | 335 |
| 5-7: VPM Osc 4 | 335 |
| 5-8: VPM Osc 5 | 335 |
| 5-9: VPM Osc 6 | 335 |
| PROGRAM > MOD-7: Filter | 336 |
| 6-1: Basic | 336 |
| 6-2: Multi Filter | 336 |
| 6-3: Filter Mod | 336 |
| 6-4: Filter LFO Mod | 336 |
| PROGRAM > MOD-7: Amp & Mixer | 337 |
| 7-1: Mixers 1-3 | 337 |
| 7-2: Output Mixer | 338 |
| 7-3: Amp | 339 |
| 7-4: Amp Modulation | 339 |
| 7-5: Amp EG | 339 |
| PROGRAM > MOD-7: EG | 340 |
| 8-1: EG 1 | 340 |
| 8-2: EG 2 | 343 |
| 8-3: EG 3 | 343 |
| 8-4: EG 4 | 343 |
| 8-5: EG 5 | 343 |
| 8-6: EG 6 | 343 |
| 8-7: EG 7 | 343 |
| 8-8: EG 8 | 343 |
| 8-9: EG 9 | 343 |
| PROGRAM > MOD-7: Seq, LFO, and AMS Mixers | 344 |
| 9-1: Step Sequencer | 344 |
| 9-2: LFO 1 | 344 |
| 9-3: LFO 2 | 344 |
| 9-4: LFO 3 | 344 |
| 9-5: LFO 4 | 344 |
| 9-6: AMS Mixers 1/2 | 344 |
| 9-7: AMS Mixers 3/4 | 344 |
| 9-8: AMS Mixers 5/6 | 344 |
| 9-9: AMS Mixers 7/8 | 344 |
| MOD-7: Tone Adjust | 345 |
| EXi MOD-7: Page Menu Commands | 347 |
| <hr/> | |
| EXi: SGX-2 Premium Piano | 349 |
| SGX-2 Overview | 349 |
| EXi PROGRAM > SGX-2: Home | 350 |
| 0-1: Overview | 350 |
| PROGRAM > SGX-2: Main | 352 |
| 4-1: Main | 352 |
| PROGRAM > SGX-2: String Resonance/ Una Corda | 354 |
| 5-1: String Resonance/Una Corda | 354 |
| SGX-2: Tone adjust | 356 |
| EXi SGX-2: Page Menu Commands | 357 |

| | |
|---|------------|
| EXi: EP-1 MDS Electric Piano | 359 |
| EP-1 Overview | 359 |
| On-screen knobs, sliders & switches and the Parameter Details area | 360 |
| EXi PROGRAM > EP-1: Home | 361 |
| 0-1: Overview | 361 |
| EXi PROGRAM > EP-1: Basic/Oscillator | 362 |
| 4-1: Basic | 362 |
| 4-2: Oscillator | 364 |
| EXi PROGRAM > EP-1: Panel/IFX/Amp | 366 |
| 5-1: Common | 366 |
| Tine EP | 367 |
| Reed EP | 369 |
| Insert Effects | 370 |
| EXi PROGRAM > EP-1: AMS Mixers | 374 |
| EP-1: Tone Adjust | 375 |
| EXi EP-1: Page Menu Commands | 376 |

COMBINATION mode

| | |
|--|------------|
| COMBINATION > Home | 377 |
| 0-1: Mixer | 377 |
| Quick Layer | 384 |
| Quick Split | 387 |
| 0-2: Performance Meters | 389 |
| 0-6: ARP DRUM | 390 |
| 0-8: Sampling | 392 |
| 0-9: Tone Adjust | 394 |
| COMBINATION > EQ/X-Y/Controllers | 396 |
| 1-1: Timbre EQ | 396 |
| 1-5: X-Y Volume | 397 |
| 1-6: X-Y CC | 401 |
| 1-7: X-Y Envelope | 403 |
| 1-8: Controllers | 404 |
| COMBINATION > Timbre Parameters | 405 |
| 2-1: MIDI | 405 |
| 2-2: OSC | 406 |
| 2-3: Pitch | 408 |
| 2-4: Delay | 409 |
| 2-5: Wave Seq/ARP | 410 |
| 2-6: EXi Audio Input | 412 |
| COMBINATION > MIDI Filter/Zones | 413 |
| 3-1: MIDI Filter1 | 413 |
| 3-2: MIDI Filter2 | 415 |
| 3-3: MIDI Filter3 | 416 |
| 3-5: Keyboard Zones | 417 |
| 3-6: Velocity Zones | 419 |
| COMBINATION > IFX | 421 |
| 8-1: Routing1 | 421 |
| 8-2: Routing2 | 424 |
| 8-5: Insert FX | 425 |
| 8-7: IFX 1-12 | 427 |
| 8-9: Common FX LFO | 429 |

COMBINATION > MFX/TFX

| | |
|--------------------|-----|
| 9-1: Routing | 430 |
| 9-2: MFX1 | 431 |
| 9-3: MFX2 | 432 |
| 9-4: TFX1 | 432 |
| 9-5: TFX2 | 432 |

COMBINATION: Page Menu Commands

SEQUENCER mode

Sequencer Overview

| | |
|---------------------------------------|-----|
| MIDI sequencer | 439 |
| Setup parameters & Musical data | 441 |

SEQUENCER > Home

| | |
|----------------------------|-----|
| 0-1: Mixer | 443 |
| 0-5: MIDI Track Loop | 454 |
| 0-6: Recording Setup | 456 |
| 0-7: ARP DRUM | 460 |
| 0-8: Sampling | 462 |
| 0-9: Tone Adjust | 464 |

SEQUENCER > EQ/X-Y/Controllers

| | |
|---------------------------|-----|
| 1-1: MIDI Track EQ | 466 |
| 1-2: Audio Track EQ | 468 |
| 1-5: X-Y Volume | 469 |
| 1-6: X-Y CC | 472 |
| 1-7: X-Y Envelope | 474 |
| 1-8: Controllers | 476 |

SEQUENCER > Track Parameters

| | |
|------------------------------|-----|
| 2-1: MIDI | 478 |
| 2-2: OSC | 480 |
| 2-3: Pitch | 482 |
| 2-4: Delay | 484 |
| 2-5: Wave Seq/ARP | 485 |
| 2-6: EXi Audio Input | 487 |
| 2-7: Audio Track Delay | 488 |

SEQUENCER > MIDI Filter/Zones

| | |
|---------------------------|-----|
| 3-1: MIDI Filter1 | 489 |
| 3-2: MIDI Filter2 | 491 |
| 3-3: MIDI Filter3 | 492 |
| 3-5: Keyboard Zones | 493 |
| 3-6: Velocity Zones | 495 |

SEQUENCER > Track Edit

| | |
|-----------------------------|-----|
| 4-1: Track Edit | 497 |
| 4-2: MIDI Track Name | 499 |
| 4-3: Audio Track Name | 500 |

SEQUENCER > Pattern/RPPR

| | |
|-------------------------|-----|
| 5-1: Pattern Edit | 501 |
| 5-2: Pattern Name | 503 |
| 5-3: RPPR Setup | 504 |

SEQUENCER > IFX

| | |
|---------------------------|-----|
| 8-1: MIDI Routing1 | 507 |
| 8-2: MIDI Routing2 | 509 |
| 8-3: Audio Routing1 | 511 |
| 8-4: Audio Routing2 | 512 |
| 8-5: Insert FX | 513 |
| 8-7: IFX 1-12 | 515 |
| 8-9: Common FX LFO | 517 |

| | |
|--|------------|
| SEQUENCER > MFX/TFX | 518 |
| 9-1: Routing | 518 |
| 9-2: MFX1 | 519 |
| 9-3: MFX2 | 520 |
| 9-4: TFX1 | 520 |
| 9-5: TFX2 | 520 |
| SEQUENCER: Page Menu Commands | 521 |
| System Exclusive events supported in Sequencer mode | 557 |
| <hr/> | |
| SET LIST mode | 559 |
| Overview | 559 |
| SET LIST > Home | 560 |
| 0-1: Play | 560 |
| SET LIST > Edit | 565 |
| 1-1: Edit | 565 |
| SET LIST: Page Menu Commands | 569 |
| <hr/> | |
| SAMPLING mode | 571 |
| Sampling Overview | 571 |
| Sampling to RAM, or direct to drive | 571 |
| Sampling features | 572 |
| SAMPLING > Recording | 574 |
| 0-1: Recording | 574 |
| 0-8: Audio Input | 581 |
| SAMPLING > Sample Edit | 586 |
| 1-1: Sample Edit | 586 |
| SAMPLING > Loop Edit | 589 |
| 2-1: Loop Edit | 589 |
| SAMPLING > Multisample Edit | 592 |
| 3-1: Multisample Edit | 592 |
| SAMPLING > EQ | 594 |
| 4-1: EQ | 594 |
| SAMPLING > IFX | 595 |
| 8-1: Routing | 595 |
| 8-5: Insert FX | 597 |
| 8-7: IFX 1-12 | 599 |
| 8-9: Common FX LFO | 600 |
| SAMPLING > MFX/TFX | 601 |
| 9-1: Routing | 601 |
| 9-2: MFX1 | 603 |
| 9-3: MFX2 | 604 |
| 9-4: TFX1 | 604 |
| 9-5: TFX2 | 604 |
| SAMPLING: Page Menu Commands | 605 |

| | |
|---|------------|
| GLOBAL mode | 631 |
| GLOBAL > Basic Setup | 631 |
| 0-1: Basic | 631 |
| 0-2: Audio | 637 |
| 0-3: KSC Auto-Load | 640 |
| 0-4: Sample Manage | 643 |
| 0-5: Network | 645 |
| 0-8: Quick Access | 647 |
| 0-9: Manual Info | 650 |
| GLOBAL > MIDI | 651 |
| 1-1: MIDI | 651 |
| GLOBAL > Wave Sequence | 657 |
| 2-1: Seq. Parameter | 657 |
| 2-2: Step Parameter | 661 |
| GLOBAL > Category Name | 665 |
| 3-1: Program Category | 665 |
| 3-2: Combi Category | 666 |
| GLOBAL > Drum Kit | 667 |
| 4-1: Sample Setup | 668 |
| 4-2: Sample Parameter | 671 |
| 4-3: Voice/Mixer | 673 |
| GLOBAL > Controllers/Scales | 675 |
| 5-1: Controllers | 675 |
| 5-2: User Scales | 677 |
| 5-3: Function Assign | 678 |
| GLOBAL > Arpeggio Pattern | 680 |
| 6-1: Arpeggio Pattern | 681 |
| GLOBAL > Options Info | 684 |
| 7-1: Options Info | 684 |
| GLOBAL: Page Menu Commands | 686 |
| <hr/> | |
| MEDIA mode | 695 |
| MEDIA | 697 |
| 0-1: Load | 697 |
| 0-2: Save | 700 |
| 0-3: Utility | 701 |
| 0-9: Media Info | 702 |
| MEDIA: Page Menu Commands | 703 |

Effect Guide 731**Overview 731**

| | |
|--|-----|
| Effects in each mode..... | 732 |
| Dynamic modulation (Dmod) and Tempo Synchronization..... | 734 |
| Common FX LFOs..... | 735 |
| FX Control Buses..... | 735 |
| Effect I/O..... | 737 |

Insert Effects (IFX1...IFX12)..... 739

| | |
|--|-----|
| In/Out..... | 739 |
| Routing..... | 740 |
| Mixer..... | 748 |
| Controlling the Insert Effects via MIDI..... | 750 |

Master Effects (MFX1, 2)..... 751

| | |
|--|-----|
| In/Out..... | 751 |
| Routing..... | 752 |
| Mixer..... | 755 |
| Controlling the Master Effects via MIDI..... | 756 |

Total Effects (TFX1, 2)..... 757

| | |
|--|-----|
| In/Out..... | 757 |
| Routing..... | 757 |
| Mixer..... | 758 |
| Using MIDI to control the Total Effects..... | 758 |

Outputs 759

| | |
|-------------------------|-----|
| Main Outputs..... | 759 |
| Individual Outputs..... | 759 |

Effect/Mixer Block Diagrams..... 760**Dynamics..... 763**

| | |
|------------------------------------|-----|
| 000: No Effect..... | 763 |
| 001: Stereo Dyna Compressor..... | 763 |
| 002: Stereo Compressor..... | 764 |
| 003: Stereo Expander..... | 767 |
| 004: St.Multiband Compressor..... | 768 |
| 005: Stereo Limiter..... | 770 |
| 006: Multiband Limiter..... | 771 |
| 007: Stereo Multiband Limiter..... | 772 |
| 008: Stereo Mastering Limiter..... | 773 |
| 009: Stereo Gate..... | 774 |
| 010: Stereo Noise Reduction..... | 775 |

EQ and Filters..... 776

| | |
|----------------------------------|-----|
| 011: Stereo Parametric 4EQ..... | 776 |
| 012: Stereo Graphic 7EQ..... | 777 |
| 013: Stereo Master 3EQ..... | 778 |
| 014: Stereo Exciter/Enhncr..... | 779 |
| 015: Stereo Isolator..... | 780 |
| 016: Stereo Wah/Auto Wah..... | 780 |
| 017: St. Vintage/Custom Wah..... | 782 |
| 018: Stereo Random Filter..... | 783 |
| 019: Multi Mode Filter..... | 784 |
| 020: Stereo Sub Oscillator..... | 785 |
| 021: Talking Modulator..... | 786 |
| 022: Stereo Decimator..... | 787 |
| 023: Stereo Analog Record..... | 788 |
| 024: Stereo Wave Shaper..... | 788 |
| 025: Piano Body/Damper..... | 790 |
| 026: Vocoder..... | 790 |

Overdrive, Amp models, and Mic models 792

| | |
|-------------------------------------|-----|
| 027: OD/Hi-Gain Wah..... | 792 |
| 028: OD/HyperGain Wah..... | 793 |
| 029: Stereo Guitar Cabinet..... | 794 |
| 030: Guitar Amp Model +P4EQ..... | 794 |
| 031: Guitar Amp Model +Cabinet..... | 795 |
| 032: Stereo Bass Cabinet..... | 796 |
| 033: Bass Amp Model..... | 796 |
| 034: Bass Amp Model +Cabinet..... | 797 |
| 035: Bass Amp TubeDrive +Cab..... | 798 |
| 036: Tube PreAmp Modeling..... | 799 |
| 037: St. Tube PreAmp Modeling..... | 799 |
| 038: Mic Modeling +PreAmp..... | 800 |
| 039: St. Mic Modeling +PreAmp..... | 800 |

Chorus, Flanger, and Phaser 801

| | |
|------------------------------------|-----|
| 040: Stereo Chorus..... | 801 |
| 041: Stereo Harmonic Chorus..... | 802 |
| 042: St. Bi-phase Modulation..... | 803 |
| 043: Multitap Cho/Delay 4Taps..... | 804 |
| 044: Multitap Cho/Delay 6Taps..... | 804 |
| 045: Bi Chorus..... | 805 |
| 046: Ensemble..... | 807 |
| 047: Polysix Ensemble..... | 807 |
| 048: Stereo Flanger..... | 808 |
| 049: Stereo Random Flanger..... | 809 |
| 050: Stereo Envelope Flanger..... | 809 |
| 051: Stereo Phaser..... | 810 |
| 052: Stereo Random Phaser..... | 811 |
| 053: Stereo Envelope Phaser..... | 812 |
| 054: Bi Phaser..... | 813 |

Modulation and Pitch Shift 814

| | |
|------------------------------------|-----|
| 055: Stereo Vibrato..... | 814 |
| 056: Stereo Auto Fade Mod..... | 815 |
| 057: 2-Voice Resonator..... | 816 |
| 058: Doppler..... | 817 |
| 059: Scratch..... | 818 |
| 060: Grain Shifter..... | 818 |
| 061: Stereo Tremolo..... | 819 |
| 062: Stereo Envelope Tremolo..... | 820 |
| 063: Stereo Auto Pan..... | 821 |
| 064: Stereo Phaser+Tremolo..... | 822 |
| 065: Stereo Ring Modulator..... | 823 |
| 066: Stereo Frequency Shifter..... | 824 |
| 067: Detune..... | 825 |
| 068: Pitch Shifter..... | 825 |
| 069: Stereo Pitch Shifter..... | 826 |
| 070: Pitch Shifter BPM..... | 827 |
| 071: Stereo Pitch Shifter BPM..... | 828 |
| 072: Pitch Shift Mod..... | 829 |
| 073: Organ Vibrato/Chorus..... | 830 |
| 074: Rotary Speaker..... | 830 |
| 075: Rotary Speaker Pro OD..... | 832 |
| 076: Rotary Speaker Pro CX..... | 833 |

Delay..... 835

| | |
|-----------------------------------|-----|
| 077: L/C/R Delay..... | 835 |
| 078: L/C/R Long Delay..... | 835 |
| 079: Stereo/Cross Delay..... | 836 |
| 080: Stereo/Cross Long Delay..... | 837 |
| 081: Stereo Multitap Delay..... | 837 |
| 082: Stereo Modulation Delay..... | 838 |

| | |
|--------------------------------|-----|
| 083: Stereo Dynamic Delay | 839 |
| 084: Stereo Auto Panning Delay | 840 |
| 085: Tape Echo | 841 |
| 086: Multiband Mod. Delay | 842 |
| 087: Reverse Delay | 843 |
| 088: Hold Delay | 844 |
| 089: Auto Reverse | 845 |
| 090: Sequence BPM Delay | 846 |
| 091: L/C/R BPM Delay | 847 |
| 092: L/C/R BPM Long Delay | 848 |
| 093: Stereo BPM Delay | 849 |
| 094: Stereo BPM Long Delay | 850 |
| 095: Stereo BPM Multitap Delay | 851 |
| 096: Stereo BPM Mod. Delay | 852 |
| 097: St. BPM Auto Panning Dly | 853 |
| 098: Tape BPM Echo | 854 |
| 099: Reverse BPM Delay | 855 |

Reverb and Early Reflections.....857

| | |
|--------------------------------|-----|
| 100: Overb. | 857 |
| 101: Reverb Hall | 858 |
| 102: Reverb Smooth Hall | 858 |
| 103: Reverb Wet Plate | 858 |
| 104: Reverb Dry Plate | 858 |
| 105: Reverb Room | 859 |
| 106: Reverb Bright Room | 859 |
| 107: Early Reflections | 860 |
| 108: Early Reflections Hi Dens | 860 |

Mono-Mono Serial862

| | |
|---------------------------------|-----|
| 109: P4EQ - Exciter | 865 |
| 110: P4EQ - Wah | 865 |
| 111: P4EQ - Chorus/Flanger | 865 |
| 112: P4EQ - Phaser | 866 |
| 113: P4EQ - Multitap Delay | 866 |
| 114: Comp - Wah | 866 |
| 115: Comp - Amp Sim | 867 |
| 116: Comp - OD/HiGain | 867 |
| 117: Comp - P4EQ | 867 |
| 118: Comp - Chorus/Flanger | 868 |
| 119: Comp - Phaser | 868 |
| 120: Comp - Multitap Delay | 869 |
| 121: Limiter - P4EQ | 869 |
| 122: Limiter - Chorus/Flanger | 869 |
| 123: Limiter - Phaser | 870 |
| 124: Limiter - Multitap Delay | 870 |
| 125: Exciter - Comp | 871 |
| 126: Exciter - Limiter | 871 |
| 127: Exciter - Chorus/Flanger | 871 |
| 128: Exciter - Phaser | 872 |
| 129: Exciter - Multitap Delay | 872 |
| 130: OD/Hi Gain - Amp Sim | 872 |
| 131: OD/Hi Gain - Cho/Flanger | 873 |
| 132: OD/Hi Gain - Phaser | 873 |
| 133: OD/Hi Gain - Multitap Dly | 873 |
| 134: Wah - Amp Sim | 874 |
| 135: Decimator - Amp Sim | 874 |
| 136: Decimator - Comp | 875 |
| 137: Amp Sim - Tremolo | 875 |
| 138: Cho/Flanger - Multitap Dly | 876 |
| 139: Phaser - Chorus/Flanger | 876 |
| 140: Reverb - Gate | 876 |

Mono/Mono Parallel.....878

| | |
|--------------------------------|-----|
| 141: P4EQ // P4EQ | 881 |
| 142: P4EQ // Comp | 881 |
| 143: P4EQ // Limiter | 882 |
| 144: P4EQ // Exciter | 882 |
| 145: P4EQ // OD/Hi Gain | 882 |
| 146: P4EQ // Wah | 882 |
| 147: P4EQ // Chorus/Flanger | 883 |
| 148: P4EQ // Phaser | 883 |
| 149: P4EQ // Multitap BPM Dly | 883 |
| 150: Comp // Comp | 883 |
| 151: Comp // Limiter | 884 |
| 152: Comp // Exciter | 884 |
| 153: Comp // OD/Hi Gain | 884 |
| 154: Comp // Wah | 884 |
| 155: Comp // Chorus/Flanger | 885 |
| 156: Comp // Phaser | 885 |
| 157: Comp // Multitap BPM Dly | 885 |
| 158: Limiter // Limiter | 885 |
| 159: Limiter // Exciter | 886 |
| 160: Limiter // OD/Hi Gain | 886 |
| 161: Limiter // Wah | 886 |
| 162: Limiter // Chorus/Flanger | 886 |
| 163: Limiter // Phaser | 887 |
| 164: Limiter // Mtap BPM Dly | 887 |
| 165: Exciter // Exciter | 887 |
| 166: Exciter // OD/Hi Gain | 887 |
| 167: Exciter // Wah | 888 |
| 168: Exciter // Chorus/Flanger | 888 |
| 169: Exciter // Phaser | 888 |
| 170: Exciter // Mtap BPM Dly | 888 |
| 171: OD/Hi Gain // OD/Hi Gain | 889 |
| 172: OD/Hi Gain // Wah | 889 |
| 173: OD/Hi Gain // Cho/Flanger | 889 |
| 174: OD/Hi Gain // Phaser | 889 |
| 175: OD/Hi Gain // Mt BPM Dly | 890 |
| 176: Wah // Wah | 890 |
| 177: Wah // Chorus/Flanger | 890 |
| 178: Wah // Phaser | 890 |
| 179: Wah // Multitap BPM Dly | 891 |
| 180: Cho/Flange // Cho/Flanger | 891 |
| 181: Cho/Flange // Phaser | 891 |
| 182: Cho/Flange // Mt BPM Dly | 891 |
| 183: Phaser // Phaser | 892 |
| 184: Phaser // Mtap BPM Dly | 892 |
| 185: Mt.BPM Dly // Mt.BPM Dly | 892 |

Vintage.....893

| | |
|-----------------------------------|-----|
| 186: Small Phase | 893 |
| 187: Orange Phase | 893 |
| 188: Black Phase | 894 |
| 189: Vintage Chorus | 894 |
| 190: Black Chorus | 895 |
| 191: EP Chorus | 895 |
| 192: Vintage Flanger | 896 |
| 193: Red Comp | 896 |
| 194: Vox Wah | 897 |
| 195: Stereo EP Cabinet | 898 |
| 196: Rotary Speaker Amp Model | 898 |
| 197: Rotary Speaker Pro CX Custom | 899 |

| | |
|---|------------|
| Appendices | 901 |
| Alternate Modulation Sources (AMS) | 901 |
| Alternate Modulation Overview | 901 |
| Alternate Modulation Source (AMS) List | 903 |
| Alternate Modulation settings | 907 |
| Dynamic Modulation Sources (Dmod) | 912 |
| Overview | 912 |
| Dynamic Modulation Source List | 912 |
| Controller Assignments | 915 |
| SW1/2 Assignments | 915 |
| RT Control Knobs 1–6 Assignments | 916 |
| Foot Switch Assignments | 917 |
| Foot Pedal Assignments | 919 |
| MIDI transmission from NAUTILUS | |
| controllers | 920 |
| NAUTILUS and MIDI CCs | 923 |
| Responses to standard MIDI controllers | 923 |
| Parameters controlled by MIDI CCs #70-79 | 926 |
| MIDI applications | 929 |
| About MIDI | 929 |
| Connecting MIDI devices & computers | 929 |
| USB MIDI controllers | 930 |
| Messages transmitted and received by the | |
| NAUTILUS | 931 |
| MEDIA mode and file format information | 941 |
| AIFF and WAVE format details: importing | 941 |
| AIFF and WAVE format details: exporting | 941 |
| Korg format sample files | 942 |
| OASYS .SNG file compatibility | 947 |
| CD-R/RW disks on the NAUTILUS: UDF and | |
| packet-writing | 948 |
| Notice: Use of GPL and LGPL software | 949 |
| Updating the system | 950 |
| Restoring the system and factory sounds | 951 |

PROGRAM mode: HD-1

HD-1 Overview

Flagship sampling & Wave Sequencing synth

We named the HD-1 “High Definition” because of its superior sound, starting with Korg’s proprietary low-aliasing sample playback oscillators, full-bandwidth multimode resonant filters, and extraordinarily fast & smooth envelopes and LFOs.

Virtual Memory Technology (VMT) gives the HD-1 access to gigabytes of onboard samples covering every “meat and potatoes” sound in exquisite detail, from orchestral to classic rock to hip-hop, all instantly available.

Wave Sequencing

Wave Sequences play a series of samples over time, creating distinctive rhythmic timbres or smooth, complex evolving sounds. Additionally, step-sequencer-style modulation outputs allow Wave Sequences to control any modulatable Program parameter.

In the HD-1, Wave Sequences can be used interchangeably with standard Multisamples. Wave Sequences are edited in GLOBAL mode; for more information, see “GLOBAL > Wave Sequence” on page 657.

Main Features

- Korg’s proprietary ultra-high-quality sample interpolation provides minimal aliasing, crystal-clear high frequencies, and sound that is smooth, rich, and detailed across the entire audio spectrum.
- Gigabytes of ROM and EXs sample libraries
- User Sample Banks allow multiple gigabyte-sized custom libraries
- Dual-oscillator structure, providing two complete voice chains for layers and splits
- Within each oscillator, up to eight-way velocity splits and crossfades (including two-way layers)
- Wave Sequencing, for creating rhythmic patterns or complex, evolving timbres
- Vector Synthesis
- Dual multi-mode resonant filters
- Drive and Low Boost, for adding per-voice grit, girth and distortion
- Three envelopes, two LFOs, and two AMS Mixers per OSC, plus a common LFO, X-Y envelope, and Scene setup (Arpeggiator, Drum track/Step sequencer) for the Program as a whole
- Two complex key tracking generators per OSC, plus two more for the Program as a whole
- Extensive real-time modulation capabilities

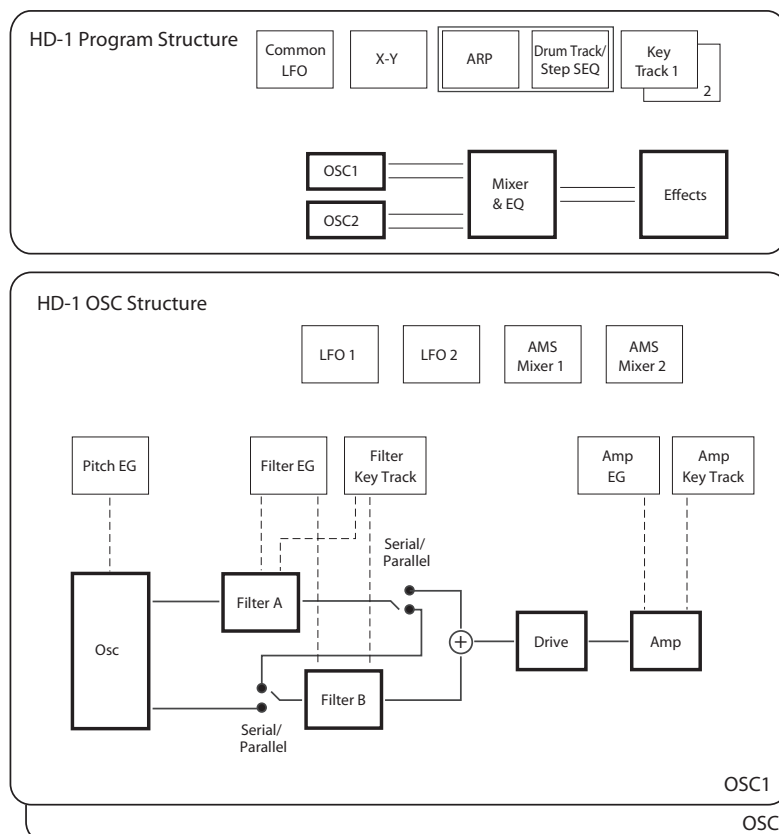

PROGRAM > Home

This is the main page of PROGRAM mode for HD-1 Programs. Among other things, you can:

- Select Programs
- Jump directly to the main editing pages
- Make edits Arpeggiator, Drum truck/Step sequencer to Scene
- Set up the audio inputs and resampling options

Page Select

Select the pages using the methods shown below.

1. Press the PAGE button to display “Page Select”.

The abbreviated names of each page are shown in “Page Select”.

2. Select the desired page using the display.

0-1: Overview



This is the main page for selecting Programs, which are the basic sounds of the NAUTILUS. It also includes an interactive overview of the most important Program parameters, such as envelopes, LFOs, Multisamples, filters, and so on. Just touch any of these overview areas, and you'll jump to the corresponding edit page.

Tip: Wherever you are in the PROGRAM mode pages, pressing EXIT three times (or fewer) will take you back to this page, and select the Program name. You can then immediately use each VALUE controller to select a different Program.

0-1a: Program Select

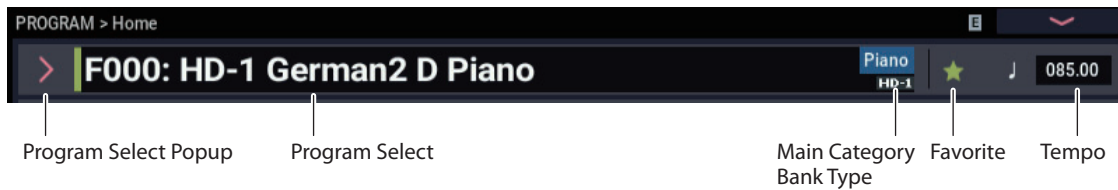

Program Select [0...127 (A...T Bank), 1...128 (GM, g(1)...g(9), g(d) Bank)]

This is the currently selected Program.

To switch between Programs, use the VALUE controller or the Program Select menu.

Changing the Program

- Select “Program Select” using the VALUE dial or the +/- buttons.
- Select from the Programs displayed by bank in the Bank/Program Select menu. For more information, see “Bank/Program Select menu” on page 6.
- Select from the Programs displayed by category in the Category/Program Select menu. For more information, see “Category/Program Select menu” on page 5.
- Use the Favorites feature to display and select Programs whose “Favorite” setting is on in the Bank/Program Select menu or the Category/Program Select menu.
- Use the foot switch to switch Programs. For more information, see “Foot Switch Assign” on page 675, “Foot Switch Assignments” on page 917.
- Transmit a MIDI program change message from an external MIDI device connected to the NAUTILUS.

Main Category [00...18]

Displays the main category for the Program. Each Program is categorized into up to 18 categories, and each category contains eight sub-categories.

Bank Type [(HD-1, EXi)]

This shows whether the current Bank contains HD-1 Programs or EXi Programs. The two Program types can't be mixed in a single bank.

HD-1: The Bank contains HD-1 Programs.

EXi: The Bank contains EXi Programs.

Changing the Program Bank Types

Banks can contain either HD-1 Programs or EXi Programs, but not both. This assignment can be set separately for each bank. To change the Program bank type, use the “Set Program Bank Type” page menu command in the GLOBAL > Basic- Basic Setup page. For more information, see “Set Program Bank Type” on page 686.

Note: Set the bank to “HD-1” when exporting resampled multisamples as Programs. These multisamples cannot be exported to banks set as “EXi”.

Favorite [Off, On]

On (checked): The selected Program(s) will be added to the favorites. For more information, see “Favorite” on page 7.

Tempo (♩) [040.00...300.00, EXT]

This is the tempo for the current Program, which applies to tempo-synced LFOs and Wave Sequences, Arpeggiator, Drum Track, and tempo-synced effects.

040.00...300.00 allow you to set a specific tempo in BPM, with 1/100 BPM accuracy. In addition to using each VALUE controller, or by playing a few quarter-notes on the TAP button. To set values below the decimal point, hold down the ENTER button and input the value with the VALUE controller.

EXT means that the tempo will sync to external MIDI clocks. You'll see this if the Global MIDI page **MIDI Clock** parameter is set to **External MIDI or USB**, or if it's set to **Auto MIDI** or **Auto USB** and the NAUTILUS is currently receiving MIDI clocks. For more information, please see “MIDI Clock (MIDI Clock Source)” on page 653.

0-1b: Overview and Page Jump

This section shows an overview of the important Program settings, such as the selected Multisamples or Wave Sequences and their velocity ranges, filter settings, EGs and LFOs, and so on.

The graphics give you a quick way to check all of these settings at a glance. They also let you jump instantly to any of the displayed parameters. Just touch one of the graphics, and you'll jump to the page containing its parameters. For instance, if you touch the Filter EG graphic, you'll go to the Filter EG page.

OSC1

OSC1 Graphic or Multisample/Wave Sequence/Drum Kit names

This area either shows the names of the Multisamples, Wave Sequences, or Drum Kit assigned to OSC1, or a graphic representing the type of sound.

Whether names or the graphic are displayed is controlled by the **Show MS/WS/DKit Graphics** menu command. For more information, see “Show MS/WS/DKit Graphics” on page 113 and “1-1h: Play Page MS/WS/DKit Display” on page 40.

If names are shown, colors and abbreviations are used to distinguish between various possibilities, as detailed below:

- The “GLOBAL > Basic Setup: Play Page Overview, Show MS/WS/DKit Graphics” checkbox is selected.
- “Show MS/WS/DKit Graphic” (“PROGRAM > Home page” menu command) checkbox is selected.

Touch this area to jump to the corresponding PROGRAM > OSC/Ptich- OSC1 Basic page.

Key Zone

This indicates the key zone in which OSC1 will sound. The 61-, 73- or 88-note keyboard region is also shown.

Touch this area to jump to the corresponding PROGRAM > Basic/X-Y/Controllers– Program Basic page.

MS1...8, Velocity Zone Graphic

This shows the velocity zones for OSC 1 multisamples 1–4.

Touch this area to jump to the corresponding PROGRAM > OSC/Pitch– OSC1 Basic page.

OSC1 LFO1, OSC1 LFO2 Graphic

This shows the waveforms of OSC1 LFO1 and OSC1 LFO2. If “MIDI/Tempo Sync” is selected, this will indicate “MIDI.”

Touch this area to jump to the corresponding PROGRAM > LFO– OSC1 LFO1 page or OSC1 LFO2 page.

Filter 1

Filter Routing & Type

This shows the filter 1 routing and filter type.

Touch this area to jump to the corresponding PROGRAM > Filter– Filter1 page.

Filter Graphic

This shows the cutoff frequency.

Touch this area to jump to the PROGRAM > Filter– Filter1 page.

Filter EG Graphic

This shows the shape of the filter 1 EG.

Touch this area to jump to the corresponding PROGRAM > Filter– Filter1 EG page.

Amp 1

Drive, Low Boost, Pan, Amp Level

This area shows the Amp 1 **Driver**, **Low Boost**, **Pan**, and **Amp Level** values.

If **Bypass** is on, **Drive** and **Low Boost** are not shown.

Touch this area to jump to the corresponding PROGRAM > Amp/EQ– Amp1/Drive1 page.

Amp EG Graphic

This shows the shape of the amp 1 EG.

Touch this area to jump to the corresponding PROGRAM > Amp/EQ– Amp1 EG page.

When you press the Quick Layer or Quick Split buttons, the Quick Layer or Quick Split dialog box appears. For detailed descriptions, see “Quick Layer,” below, and “Quick Split” on page 11.

0–1d: Common

3Band EQ Graphic

This shows the MID-sweepable three-band EQ.

Touch this area to jump to the PROGRAM > Amp/EQ– EQ page.

Mute (1) [On, Off]

When this button is on, oscillator 1 will be muted.

Mute (2) [On, Off]

When this button is on, oscillator 2 will be muted.

Mute (DrumT) [On, Off]

When this button is on, the drum track or the step sequencer will be muted.

OSC 1 Volume [000...127]

Adjusts the volume level of oscillator 1.

OSC 2 Volume [000...127]

Adjusts the volume level of oscillator 2.

Drum Track Volume [000...127]

Adjusts the volume of the drum track or the step sequencer.

0–1c: Quick Layer and Quick Split buttons

These buttons access the Quick Layer and Quick Split features, which make it easy to create simple layers and splits. Starting with either a Program or Combination, you can add another Program as a layer, or split the keyboard so that the current sound plays on one side of the keyboard (either upper or lower), and a different Program plays on the other.

Program Select menu

Category/Program Select menu

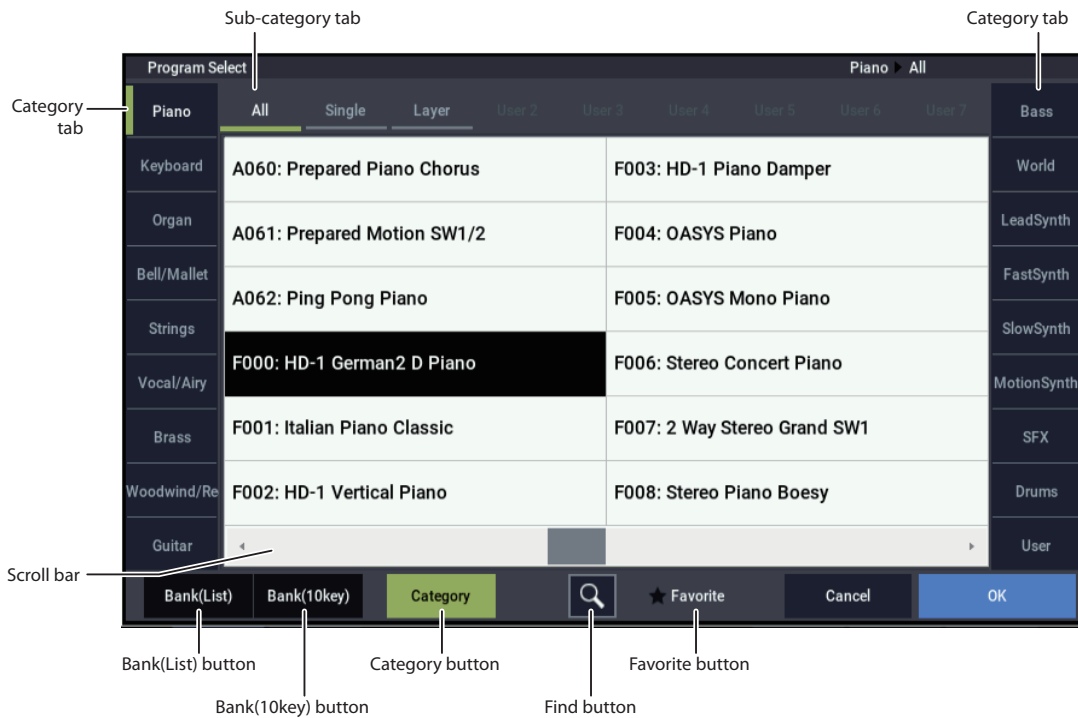

1. Press the Program Select Popup button, then press the Category button to open the Category/Program Select menu.

2. Press one of the tabs on the left or right to select the desired category.

If no Programs are assigned to a particular category or sub-category, you won't be able to select its tab.

3. Press a tab in the top to select a sub-category.

This displays Programs categorized by sub-categories. The tabs will be disabled for sub-categories to which Programs have not been assigned.

All: All programs in the category will be shown. Choose this when you don't need to use sub-categories.

0...7: The programs will be shown by sub-category.

4. Select a program from the list.

You can touch a Program's name directly, or use the + and - buttons or VALUE dial.

If there are more Programs than can be shown on the screen at one time, use the scroll bar to browse through the entire Category.

5. The Favorite check-box trims the list to show only Programs you've marked as favorites.

If the selected Category contains no Programs marked as Favorites, the box can't be checked.

6. You can use the Find button to search for Programs by name.

For more information, see "Find dialog" on page 7.

7. Press the OK button to confirm your choice, or press the Cancel button to exit without changing the Program.

Note: You can assign a category to a Program in the "Write Program" dialog.

Bank/Program Select menu

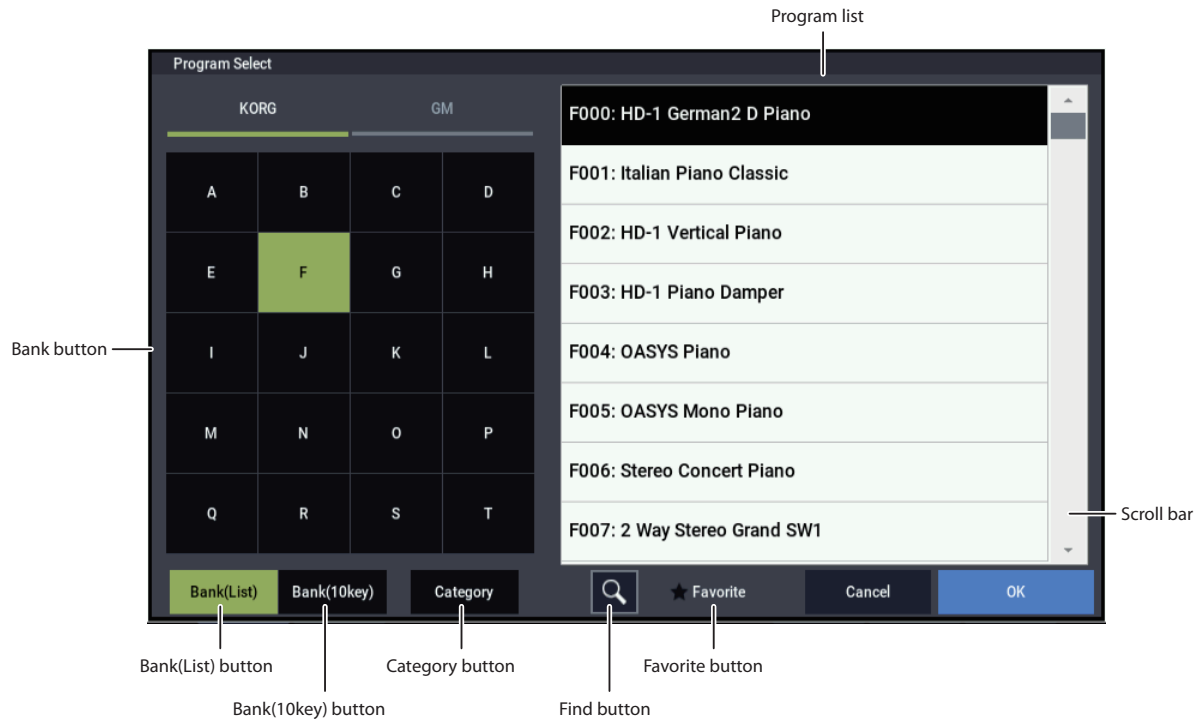

1. Press the Program Select Popup button to open the Bank/Program Select menu. Press the Bank(List) button if the Category/Program Select menu is shown.
2. Press one of the bank buttons on the left to select a specific bank.
3. Select a program from the list. You can touch a Program's name directly, or use the + and - buttons or VALUE dial.
4. The Favorite button trims the list to show only Programs you've marked as favorites. If the selected Bank contains no Programs marked as Favorites, the box can't be checked.

For more information, see "0-1b: Overview and Page Jump," below.

5. You can use the Find button to search for Programs by name.

The Find button is shown as a magnifying glass icon at the bottom of the display. For more information, see "Find dialog" on page 7.

6. Press the Bank(10key) button to switch the list to display a numeric keypad, where you can input the Program number to select.

Tips: Press the  (update) button on the numeric keypad to select a Program and check how it sounds without closing the dialog box.

7. Press the OK button to confirm your choice, or press the Cancel button to exit without changing the Program.

Banks GM, g(1...9), and g(d): General MIDI

Press the Bank(List) button to display “Bank Select”, and press the GM button.

If a GM variation bank doesn't have a different version of the current Program, the basic GM sound will be recalled instead. In this case.

Program Bank Contents

| Bank | Contents | Bank Type |
|-------------|---------------------------|--|
| A...E | EXi sounds | Bank type can be set to either HD-1 or EXi |
| F...O | HD-1 sounds | |
| P...R | Initialized EXi Programs | |
| S, T | Initialized HD-1 Programs | |
| GM | GM2 capital Programs | GM |
| g(1)...g(9) | GM2 variation Programs | |
| g(d) | GM2 drum Programs | |

- Each rewritable bank A to T has 128 programs (total 2,560), non-rewritable bank GM (GM2 capital program) and g(1)–g(9) (variation programs), and bank g(d) (drums).
- Bank M is selected as the default setting when writing a multisample resampled by the page menu command “Auto Sampling Setup” as a program.

For details on the factory Programs, please see the separate Voice Name List (VNL).

Favorite [Off, On]

This check-box, right under the Tempo parameter, marks the Program as a “favorite,” which makes it easy to find in the Bank/Program Select and Category/Program Select dialogs.

Important: you must write the Program in order to save changes to the Favorite status.

Find [Button]

This magnifying-glass button brings up the Find dialog. You can use Find to search for Programs by name, as described below.

Find dialog

The Find dialog lets you search for data by name. It's reached by the magnifying glass icon at the bottom of the Select menu for Programs, Combinations, Songs, Set Lists, Samples, Multisamples, Wave Sequences, Drum Kits, Effects, and MOD-7 algorithms.

To use it:

1. Press the magnifying glass to open the Find dialog.

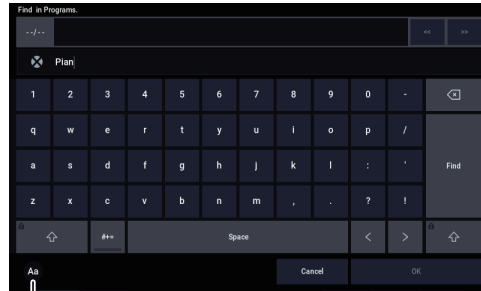

Ignore Case button

2. Enter the text to search for.

For instance, you can enter “Pian” to search for Programs with “piano” in the name. **Ignore Case button** is enabled by default; disable this if you want the find function to distinguish between upper and lower case.

In addition to the on-screen keyboard, you can use a commercially available USB alphanumeric keyboard to enter text. For more information, see “Editing names and entering text” on page 206 of the OG.

3. Press Find to find matches to the entered text.

The names of Programs which match the provided text will appear, displayed one at a time.

4. Use the Next and Previous buttons to step through the Programs. Alternatively, use the front-panel + and – buttons.

You can audition the Programs by playing on the keyboard.

5. To select a found Program, press the OK button. To exit without selecting a new Program, press the Cancel button.

Quick Layer

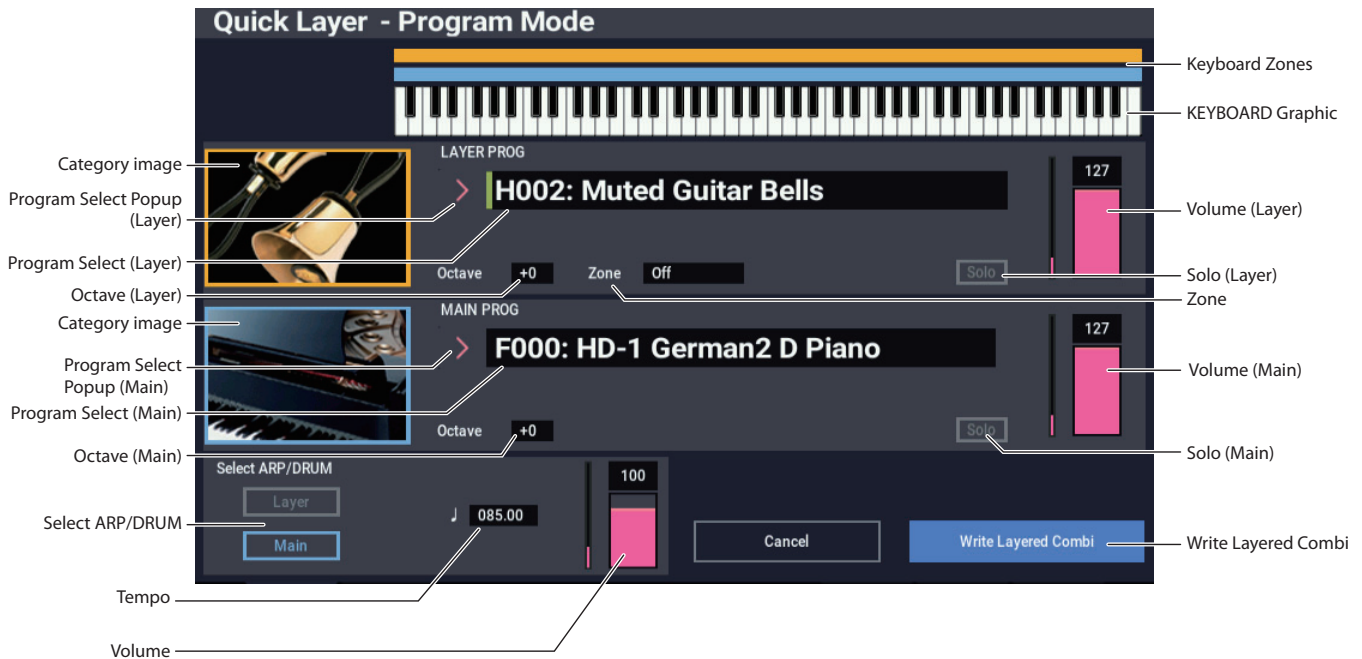

Overview

This dialog box is reached by pressing the Quick Layer button on the PROGRAM > Home page.

A “layer” is when playing a single note causes two or more sounds to be heard simultaneously. When invoked from PROGRAM mode, the Quick Layer function lets you layer two Programs together.

All of the Quick Layer controls are non-destructive and reflected immediately when playing on the keyboard. You can experiment with different settings, and fine-tune until you find the perfect sound.

Once you’re happy with the results, you can save the layer as a new Combination.

Limitations of Quick Layer/Split in PROGRAM mode

The sound of the Layer or Split Program may change due to effects usage. These factors are described in detail below.

Effects

As long as there are enough insert effect (IFX) slots, the selected Program’s insert effects (IFX) are copied into the new layer/split sound. If there are not enough available IFX slots, the Program’s effects won’t be copied, and a caution icon will appear (see “Caution messages,” below).

The Main Program will continue to use its previously assigned Master and Total Effects (MFX and TFX). The Send 1/2 levels of the Layer Program are preserved, but the MFX and TFX themselves are not. This means that the layer Program may not sound exactly the same as it did originally.

Caution messages

If there are insufficient free IFX slots to completely merge the two sounds, an exclamation point icon will appear:



Touch the icon to show information about the specific limitations encountered. Note that these limitations do not prevent the creation of the split or layer sound; they just mean that one or the other of the sounds may not be quite the same when played in the new Combination.

- “There is not enough empty slot to copy Layer’s IFX.”
- “There is not enough empty slot to copy Lower’s/Upper’s IFX.”

This message appears if the insert effect settings of the split/layer Program are not copied because there are not enough insert effect slots.

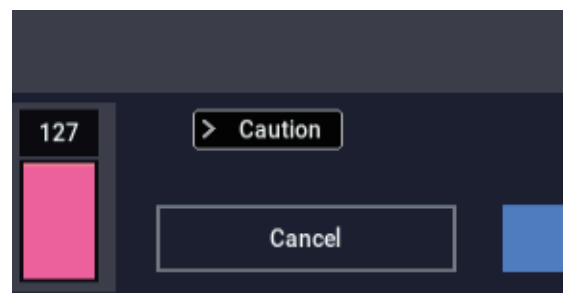

Global MIDI Channel

In PROGRAM mode, Quick Layer may not work as expected when the Global MIDI Channel (GLOBAL 1–1a) is set to 16, or set the same as the Drum Track MIDI Channel (Channel 10 by default).

Keyboard and Zone Graphics

The graphic at the top of the window shows the keyboard zones of the two sounds. The Layer Program’s note range is shown in yellow, and the Main Program’s note range is shown in light blue.

The keyboard graphic shows notes as they are played on the physical keyboard.

LAYER PROG

Layer Program Select [List of Programs]

This selects the Program that is layered onto the Main Program. You can use all of the normal Program selection methods, including bank and number, and category.

When a Layer Program is selected, some limitations may cause either the layer Program or the Main Program to sound a bit different. For more information, see “Limitations of Quick Layer/Split in PROGRAM mode” on page 8.

Category image [graphic]

This display-only graphic represents the category or sub-category of the Layer Program.

Octave [-2, -1, 0, +1, +2]

This adjusts the pitch of the Layer Program in 1-octave units. Internally, the **Octave** setting controls the Timbre’s **Transpose** parameter.

Zone [Off, Lower, Upper]

This limits the region in which the Layer Program produces sound.

Off: No limit. The Layer Program will produce sound across the entire range of the keyboard.

Lower: Only the lower notes produce sound.

Upper: Only the upper notes produce sound.

Top Key (or Bottom Key) [C-1...G9]

The name and function of this parameter changes depending on the setting of **Zone**, above.

Top Key appears if **Zone** is set to **Lower**. This sets the *highest* note at which the Layer Program produces sound.

Bottom Key appears if **Zone** is set to **Upper**. This sets the *lowest* note at which the Layer Program produces sound.

Neither parameter is shown if **Zone** is set to **Off**.

You can edit this parameter directly from either the physical keyboard or the keyboard graphic:

1. Press and hold the ENTER button.
2. While holding ENTER, play a note on the keyboard, or touch the keyboard graphic.

Volume [000...127]

This adjusts the volume of the Layer Program. The default setting is 127.

Solo [On, Off]

This turns the Solo function on/off. If Solo is enabled, only tracks with Solo On will sound; other tracks will be muted.

The setting will alternate on/off each time you press the Solo button.

MAIN PROG

(Program Select) [List of Programs]

By default, this will be the currently selected Program. You can also select a different Program, if desired. You can use all of the normal Program selection methods, including bank and number, category, and Find.

Category image

This display-only graphic represents the category or sub-category of the Main Program.

Octave [-2, -1, 0, +1, +2]

This sets the pitch of the Main Program in 1-octave units.

Internally, this edits the Timbre **Transpose** parameter.

Solo [On, Off]

This turns the Solo function on/off. If Solo is enabled, only tracks with Solo On will sound; other tracks will be muted.

The setting will alternate on/off each time you press the Solo button.

Volume [000...127]

This adjusts the volume of the Main Program. The default is 127.

ARP/DRUM

Select ARP/DRUM

You can choose to use the ARP/DRUM from either the Main or Layer Program. The Tempo is initially set to match the selected ARP/DRUM; you can then change it as desired.

When the ARP and DRUM buttons are turned on, notes can be played using the arpeggiator, drum track or step sequencer.

Note that you can’t use both Arpeggiator, Drum track/Step sequencer simultaneously.

Volume [000...127]

This adjusts the volume of the Drum Track. Initially, the value defaults to match the Drum Track volume in the source Program.

Tempo [040.00...300.00]

This sets the tempo for Arpeggiator, the Drum track or Step sequencer.

By default, this will be the tempo of the Program whose ARP/DRUM is selected; you can then change it as desired.

Write Layered Combi

When you’ve created a layer sound that you like, press the **Write Layered Combi** button to save it as a combination. The Write Combination dialog box will appear. For more information, see “Write Combination” on page 433.

After the Write is complete, the system enters COMBINATION mode with the newly created Combination selected.

Cancel

If you press the Cancel button the Quick Layer dialog box closes, and the settings are canceled.

Settings that are saved in a Combination

Timbre

The following timbres are used:

- Main Program: T01
- Layer or Split Program: T02
- Drum Track: T10

All of these Timbres (T01, 02, 10) are set to **Play**; the remaining timbres are set to **Mute**.

Volume

For both Quick Layer and Split, the **Volume** settings are applied to the Timbre **Volume** parameters.

Transpose

For both Quick Layer and Split, the **Octave** settings are applied to the Timbre **Transpose** parameters.

Effect

All IFX, MFX, and TFX settings of the Main Program are copied. IFX settings are packed forward when they are copied.

For the Layer or Split Program, IFX settings are copied if there are available free IFX; if not, the settings are not copied. Send 1/2 values are copied.

Drum

The main or layer drums that you turned on will be set to timbre 10.

The tempo value is copied from the selected Program.

MIDI Ch

When “Select ARP/DRUM” is set to “Main”, the channel settings are “T01:16ch” and “T02:Gch”; and when “Select ARP/DRUM” is set to “Layer”, the channel settings are “T01:Gch” and “T02:16ch”.

Quick Split



Overview

This dialog box is reached by pressing the Quick Split button on the PROGRAM > Home page.

A “split” means that one sound plays on the lower, left-hand side of the keyboard, and a different sound plays on the upper, right-hand side. The note at which one sound ends and the other begins is called the “split point.”

When invoked from PROGRAM mode, Quick Split lets you split the selected Program with a second Program.

All of the Quick Split controls are non-destructive and reflected immediately when playing on the keyboard. You can experiment with different settings, and fine-tune until you find the perfect sound. Once you’re happy with the results, you can save the split as a new Combination.

Limitations

Depending on the specific sounds and the Global MIDI channel setting, the sounds may change slightly when combined using Quick Split. For more information, see “Limitations of Quick Layer/Split in PROGRAM mode,” on page 8.

Split Controls & Keyboard Graphic

Select Split Mode [Lower / Main, Main / Upper]

This controls whether the Split Program is placed on the upper or lower part of the keyboard.

Lower / Main assigns the Split Program to the left-hand (lower) side of the keyboard—useful for bass sounds, for instance. This is the default.

Main / Upper assigns the Split Program to the right-hand (upper) side of the keyboard, and the Main Program to the left-hand (lower) side.

Note: When using Quick Split, the damper pedal is set to be enabled for the main Program but disabled for the lower (upper) Program. For more information, see “MIDI Filter” on page 12.

Keyboard Zones

Range in which the lower (upper) Program sounds: yellow

Range in which the main Combination sounds: light blue

Keyboard graphic

The graphic at the top of the window shows the keyboard zones of the two sounds. The Layer Program’s note range is shown in yellow, and the Main Program’s note range is shown in light blue.

The keyboard graphic shows notes as they are played on the physical keyboard.

Split Point

[C-1...G9]

The split point sets the lowest key of the Upper range; the default is C4.

You can edit this parameter directly from either the physical keyboard or the keyboard graphic:

1. **Press and hold the ENTER button.**
2. **While holding ENTER, play a note on the keyboard, or touch the keyboard graphic.**

LOWER or UPPER PROG

The name of this section changes depending on the setting of **Select Split Mode**, above.

LOWER PROG appears if **Select Split Mode** is set to **Lower / Main**.

UPPER PROG appears if **Select Split Mode** is set to **Main / Upper**.

(Program Select)**[List of Programs]**

This selects the Split Program to add to the Main Program. You can use all of the normal Program selection methods, including bank and number, category, and Find.

Category image

This display-only graphic represents the category or sub-category of the Split Program.

Octave**[-2, -1, 0, +1, +2]**

This adjusts the pitch of the Split Program in 1-octave units.

Internally, the **Octave** setting controls the Timbre's **Transpose** parameter.

Volume**[000...127]**

This adjusts the volume of the Split Program. The default setting is 127.

Solo**[On, Off]**

This turns the Solo function on/off. If Solo is enabled, only tracks with Solo On will sound; other tracks will be muted.

The setting will alternate on/off each time you press the Solo button.

MAIN PROG**(Program Select)****[List of Programs]**

By default, this will be the currently selected Program. You can also select a different Program, if desired. You can use all of the normal Program selection methods, including bank and number, category, and Find.

Category image

This display-only graphic represents the category or sub-category of the Main Program.

Octave**[-2, -1, 0, +1, +2]**

This sets the pitch of the Main Program in 1-octave units.

Internally, this edits all of the individual Timbre **Transpose** parameters.

Solo**[On, Off]**

This turns the Solo function on/off. If Solo is enabled, only tracks with Solo On will sound; other tracks will be muted.

The setting will alternate on/off each time you press the Solo button.

Volume**[000...127]**

This adjusts the volume of the Main Program. The default setting is 127.

ARP/DRUM**Select ARP/DRUM**

You can choose to use the ARP/DRUM from either the Main or Split Program. The Tempo is initially set to match the selected ARP/DRUM; you can then change it as desired.

When the ARP and DRUM buttons are turned on, notes can be played using the arpeggiator, drum track or step sequencer.

Note that you can't use both Arpeggiator, Drum track/Step sequencer simultaneously.

Volume**[000...127]**

This adjusts the volume of the Drum Track. Initially, the value defaults to match the Drum Track volume in the source Program.

Tempo**[040.00...300.00]**

This sets the tempo for Arpeggiator, Drum track or Step sequencer.

By default, this will be the tempo of the Program whose ARP/DRUM is selected; you can then change it as desired.

Write Split Combi

When you've created a layer sound that you like, press the **Write Split Combi** button to save it as a combination. The Write Combination dialog box will appear. For more information, see "Write Combination" on page 433.

After the Write is complete, the system enters COMBINATION mode with the newly created Combination selected.

Cancel

If you press the Cancel button the Quick Layer dialog box closes, and the settings are canceled.

Settings that are saved in a Combination

The settings stored in the Combination are almost the same as for Quick Layer; for more details, please see "Settings that are saved in a Combination" on page 10. Quick Split also controls the Key Zones, MIDI Filter and ARP settings, as below:

Key Zone

When using Quick Split, this is set according to the Select Split Mode and Split Point.

Also, the ARP Scan Zone will be set to match the Timbre Key Zone. Timbre Zone Bypass will turn on.

MIDI Filter

When using Quick Split, MIDI Filter - Enable Damper is turned on for the Main program Timbre (T01), and turned off for the Lower(Upper) program Timbre (T02). This is convenient for a typical piano/bass split, for instance.

✓ 0-1: Page Menu Commands

- Compare →p.112
- Write Program →p.112
- Exclusive Solo →p.113
- Show MS/WS/DKit Graphics →p.113
- Add To Set List →p.113
- Initialize Program →p.113
- Load required samples →p.114
- PAGE →p.126
- MODE →p.126

0-2: Performance Meter

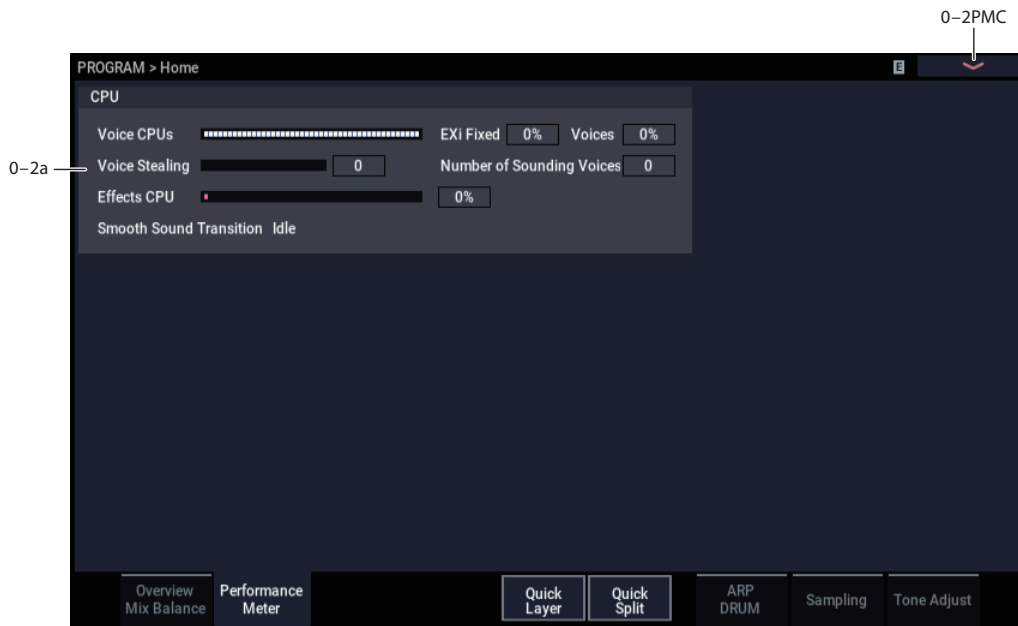

This page lets you look at the real-time performance of the NAUTILUS, including voice usage, voice stealing, and effects.

0-2a: CPU

Voice CPUs

This meter shows the amount of CPU power being used for playing voices. It uses two different colors to show the relative costs of voices and EXi fixed resources (see below). The relative percentage of each is shown numerically to the right of the meter graphic.

The figures shown are a real-time view of the actual CPU usage. Because of this, they may vary slightly even if you aren't changing anything. Also, due to the complex way in which the NAUTILUS uses the CPU, the figures may sometimes not change by much (or at all) when the number of voices changes by a small amount, or when you add or remove EXi with fixed resources.

EXi Fixed: This shows the amount of power used for EXi fixed resources, in yellow. "Fixed" means that part of the EXi starts using processing power as soon as the EXi is loaded, before playing any notes. These include effects built into the EXi, such as the amps and effects in the CX-3 and EP-1, as well as features shared by all voices, such as the MS-20EX's external signal processor. For more information, see "CX-3 & other EXi: Limitations on EXi fixed resources" on page 380.

Voices: This shows the amount of power used for currently-sounding voices, in green. This includes all HD-1 and EXi voices.

Voice Stealing

Sometimes, if a lot of voices are already sounding, there won't be enough free power to play a new voice. When this happens, the system stops older or lower-priority voices to free enough CPU power for the new voice. This is called "voice stealing." This meter shows the amount of voice stealing, in real time.

The NAUTILUS uses a complex, sophisticated system for voice stealing, which can stop voices from one synth (such as the HD-1) to make room for another (such as the PolysixEX). It also makes sure that you never have to worry about drop-outs from CPU "overs," as you do on most software systems.

In most cases, voice stealing will sound natural. Sometimes, however, you may notice that voices seem to be cutting off too early. If this occurs:

- 1. Check this meter to see whether a lot of voice stealing is happening.**

If the meter doesn't show voice stealing, then the problem is being caused by something else. If the meter does show a lot of stealing, then you can address this in several different ways. Note that these solutions apply primarily to COMBINATION and SEQUENCER modes.

- 2. In COMBINATION and SEQUENCER modes, use the Track/Timbre Priority setting to protect critical sounds from voice stealing.**

For more information, see "Timbre Priority" on page 405.

- 3. Use the Max # of Notes setting to limit the polyphony of specific Timbres or Tracks, leaving more power for other sounds.**

For more information, see "Max # of Notes" on page 407.

- 4. In SEQUENCER mode, bounce high-polyphony MIDI Tracks to Audio Tracks, and then mute the MIDI Tracks.**

Number of Sounding Voices

This shows the total number of currently sounding voices. Voices will have different CPU costs depending on which of the synth engines they use. With double Programs, various HD-1 options (see below), and layers and crossfades in COMBINATION and SEQUENCER modes, a single key on the keyboard may play a large number of voices.

In the HD-1, stereo samples use two voices each, Wave Sequences double the number of voices (two for mono, four for stereo), layered Oscillators (normal Double Programs, for instance) use separate voices for each Oscillator, and velocity cross-fades between MS use the total number of voices for both of the crossfaded sounds.

Effects CPU

The NAUTILUS uses multiple CPUs for playing synthesizer voices, and a separate CPU for effects processing including IFX, MFX, and TFX. Note that effects integrated into EXi use the voice CPUs instead, and show up on the meters as EXi fixed resources, as described above.

This meter may also show activity reflecting the mixer infrastructure.

Note that effects continue to take up processing resources even when they are turned Off or bypassed. If you want to free up the processing resources, change the effect selection to 000: No Effect.

Smooth Sound Transition

This shows whether or not the system is currently in the middle of a Smooth Sound Transition (SST). While an SST is occurring, the Effects CPU meter will generally show higher levels of activity than normal.

For more information, see “Smooth Sound Transitions” on page 121 of the OG.

Idle means that SST is not currently happening.

Active means that SST is in progress.

✓ 0-2: Page Menu Commands

- Compare →p.112
- Write Program →p.112
- Exclusive Solo →p.113
- Show MS/WS/DKit Graphics →p.113
- Add To Set List →p.113
- Load required samples →p.114
- Initialize Program →p.113
- PAGE →p.126
- MODE →p.126

0-6: ARP DRUM



This page lets you make basic adjustments to Arpeggiator.

A single arpeggiator and drum track or step sequencer can be used in PROGRAM mode.

Here we will configure an arpeggiator and drum track/step sequencer each for four scenes. You can select a scene and then change the settings of the arpeggiator and drum track/step sequencer together.

0-6a: Program Select, Tempo

| | |
|------------------|--|
| Bank | [A...T, GM, g(1...9), g(d)] |
| Bank Type | [HD-1, EXi] |
| Program | [0...127 (A...T Banks), 1...128 (GM Banks)] |
| ♩ (Tempo) | [040.00...300.00, EXT] |

Displays the Program bank, bank type, Program number and name for the currently selected Program. For more information, see “0-1a: Program Select” on page 3.

0-6b: Panel Switch (ARP, DRUM, LATCH Button)

LATCH

This switches the LATCH on/off.

On: The arpeggiator will continue playing even after you take your hand off the keyboard.

Off: The arpeggio will stop playing once you remove your hand from the keyboard.

Note: The latch will not operate while the latch settings in each arpeggiator are disabled, even if the LATCH function is on.

ARP

Switches the arpeggiator function on/off.

DRUM

Switches the drum function on/off.

0-6c: RT Control knob (Gate, Velocity, Length, Swing, Drum SD)

Displays the current values of the RT control knobs when ARP/DRUM is selected. These values can be directly changed.

Gate [-64...+63]

Adjusts the note length (gate time) for the arpeggiator and step sequencer.

Velocity [-64...+63]

Adjusts the velocity of the notes played by the arpeggiator and step sequencer.

Length [0...127]

Changes the length of the arpeggiator pattern and the step sequencer's sequence. When this is set to “127”, the arpeggio pattern or step sequencer will play back at the length set in the pattern or sequence.

Swing [-64...+63]

Adjusts the pattern of the arpeggiator or drum track, or the shuffle feel of the sequence played by the step sequencer.

Drum SD [0...127]

Changes the pattern of the drum track, or the snare drum sound used in the sequence played by the step sequencer. When this is set to “0”, the snare drum will not sound; and when this is set to “127”, the sound set in the pattern or sequence will be used.

0-6d: ARP/Drum Track/Step Sequence

This displays the arpeggio pattern, drum track (drum pattern) or step sequences A–D that are configured for the selected scene.

0-6e: Scene 1-4 Button

Selects the scene.

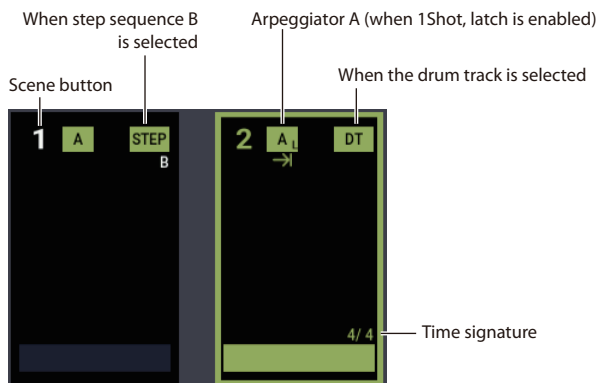

0-6f: Edit button

Switches the ARP DRUM tab page to Edit view.

You can configure the scene settings in Edit view. Here we configure the arpeggiator, drum track and step sequencer settings for each of the scene buttons.

Configures the arpeggiator and drum functions. The parameters of Scene Common Setup and Edit STEP SEQUENCE are used in common for all scenes.



Scene Common Setup

(Program for Drum) [0...127 (A...T), 1...128 (G, g(1)...g(9), g(d))]

Select the Program to be used for the drum track or step sequencer.

Scene Cue Mode

Select either “Immediately” or “Measure” for the timing to be used when you change scenes while they are playing.

Immediately: The scene will be changed right away once a new scene is selected.

Measure: After the new scene is selected, the scene will be changed upon moving to the next measure in the scene, or when the scene returns to the beginning.

Note: The length of a scene or its measures is determined by the arpeggiator or drum track/step sequencer settings in that scene. When the drum function is off, the scene length will be the length of the selected drum track or step sequencer. When the drum function is off, the length of the scene is used for the length of the arpeggiator.

Note: When the drum function is off and the arpeggiator pattern is set to the preset pattern, the “Immediately” setting will be used, since it does not have a length parameter.

More

Open the Scene Common Setup detailed settings dialog box.

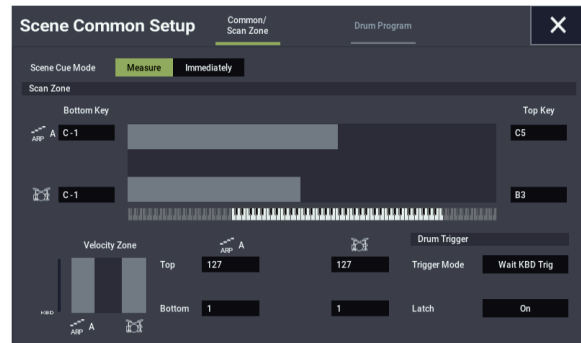

Common/Scan Zone :

Scan Zone

Bottom Key [C-1...G9]

Top Key [C-1...G9]

This sets the tonal range in which the arpeggiator operates, or the tonal range in which the drum track/step sequencer is triggered. Set the top of the range using “Top Key”, and the bottom of the range using “Bottom Key”.

VelocityZone

Bottom [001...127]

Top [001...127]

This sets the velocity range in which the arpeggiator operates, or the velocity range over which the drum track/step sequencer is triggered. Set the top of the range using “Top Velocity”, and the bottom of the range using “Bottom Velocity”.

You cannot set the top value for the keyboard or the velocity range lower than the bottom value, or the bottom value higher than the top value.

Drum Trigger

Trigger Mode [Start Immediately, Wait KBD Trig]

Start Immediately: When the DRUM function is turned on (the LED will light), the drums will start playing according to the synchronization settings. When you turn the function off, the drums will stop.

Wait KBD Trig: When the DRUM function is turned on (the LED will blink), the drums will be in standby mode. When you play the keyboard or when the NAUTILUS receives a MIDI note-on, the drums will start playing according to the synchronization settings.

When this is set to “Start Immediately”, this will always be saved as “off” for the DRUM function.

Latch [Off, On, Use Latch Button]

This is enabled when “Trigger Mode” is set to “Wait KBD Trigger”.

Off: With the DRUM function turned on (the LED will blink), the drums will start playing when a note-on is received (such as when you play a key). The drums will stop playing at note-off (when you release your fingers from the keys).

On: With the DRUM function turned on (the LED will blink), the drums will start playing when a note-on is received (such as when you play a key). The drums will also keep playing after note-off (when you release your fingers from the keys). The drums will stop playing when the DRUM function is turned off (the LED will go dark).

Use Latch Button: Turning the LATCH function off/on will turn this feature off or on, as shown above.

Drum Program:

EQ

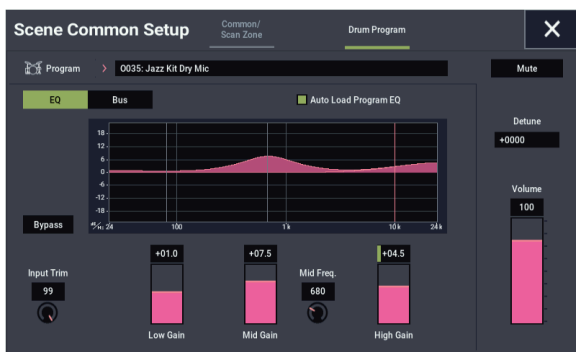

This 3-band EQ is dedicated to the Drum Track Program, and is completely separate from the main Program’s EQ.

Auto Load Program EQ [On, Off]

On (checked): When you change the drum track Program, the new Program’s EQ values will be copied automatically. This setting is the default.

After the Program is loaded, you can still edit the EQ settings as desired.

Off (unchecked): Newly selected Drum Track Program’s EQ settings will not replace the current EQ settings. Use this if you’ve edited the EQ settings, and want to keep them constant while listening to different Drum Track Programs.

Bypass [On, Off]

When Bypass is checked, all of the EQ will be disabled, including the Input Trim.

Bypass can be convenient for comparing the results of the EQ with the original signal.

Input Trim [00...99]

This controls the volume level going into the EQ. The setting corresponds with the volume, so that a value of 50 equals a volume of -6 dB and a value of 25 equals a volume of -12 dB.

High settings of the Low, Mid, and High Gain controls can cause substantial increases in the overall level. You can compensate for this by turning down the input trim.

Low Gain [-18.0...+18.0dB]

This controls the gain of the 80Hz Low Shelf EQ, in increments of 0.5dB.

Mid Gain [-18.0...+18.0dB]

This controls the gain of the Mid Sweep EQ, in increments of 0.5dB.

Mid Frequency [100Hz...10.00kHz]

This sets the center frequency for the Mid sweep EQ.

High Gain [-18.0...+18.0dB]

This controls the gain of the 10kHz High Shelf EQ, in increments of 0.5dB.

Bus

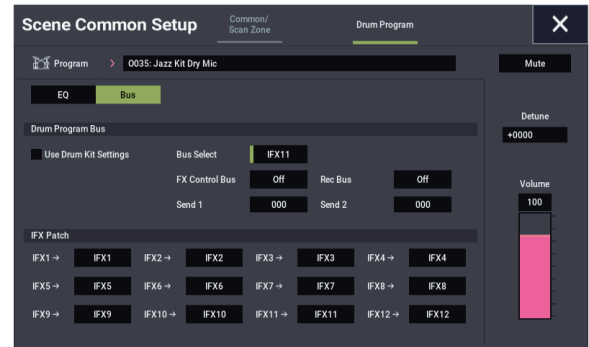

These parameters control the output and effects routing for the Drum Track Program.

Use Drum Kit Settings [Off, On]

On (checked): Drum Kits can have different **Bus Select (IFX/Indiv.Out Assign)**, **FX Control Bus**, **Send1 (to MFX1)**, and **Send2 (to MFX2)** settings (GLOBAL 4-3b) for each key. When **Use Drum Kit Settings** is **On**, these per-key settings will be used. You can use this to apply individual insert effects to specific drum instruments, or to send specific drum instruments to individual outputs.

Tip: Most of the factory Drum Kits use standard **Bus Select** settings, as detailed below:

- Snares → IFX1
- Kicks → IFX2
- Toms → IFX3
- Cymbals → IFX4
- Percussion, etc. → IFX5

For flexibility in assigning the sounds to different IFX busses, you can use the “IFX Patch” parameters, below.

Off (unchecked): The **Bus Select**, **FX Control Bus**, **Send1 (to MFX1)**, **Send2 (to MFX2)** settings will be used. All drum instruments will be sent to the specified bus.

Bus Select [L/R, IFX1...12, 1...4, 1/2...3/4, Off]

This specifies the output bus for the Drum Track Program.

L/R: The Program will go to the L/R bus. This is the default setting.

IFX1...12: The Program will go to the specified IFX bus.

1...4: The Program will be routed in mono to the specified AUDIO OUTPUT (INDIVIDUAL).

1/2...3/4: The Program will be routed in stereo, using the Pan setting, to the specified AUDIO OUTPUT (INDIVIDUAL) pair.

Off: The Program will not go to any of the outputs directly. You can use this to route the sound completely through the MFX. Use **Send1 (to MFX1)** and **Send2 (to MFX2)** to specify the send levels.

FX Control Bus [Off, 1, 2]

This sends the output of the Drum Track Program to an FX Control bus (two-channel stereo FX Ctrl 1 or 2).

Use the FX Control busses when you want a separate sound to control the audio input of an effect. You can use two FX Control busses (each is a two-channel stereo bus) to control effects in various ways.

For more information, please see “FX Control Buses” on page 735.

Rec Bus [Off, 1...4, 1/2, 3/4]

These settings send the output of the Drum Track Program to the REC busses (four mono channels: 1, 2, 3, 4).

The REC busses are dedicated internal busses for recording, used for sampling in the various modes or for recording audio tracks in SEQUENCER mode.

For more information, see “REC Bus” on page 102.

Off: The signal will not be sent to a REC bus. This is the default.

1...4: The Drum Program will be sent, in mono, to the corresponding REC bus. The **Pan** setting will be ignored.

1/2, 3/4: The Drum Program will be sent in stereo to the selected pair of REC busses. The drum program is sent to a stereo pair, either channels 1 and 2, or 3 and 4.

Send 1 [000...127]

Send 2 [000...127]

This sets the level for the drum track output signal sent to the master effect.

“Send 1” sends the signal to master effect 1.

“Send 2” sends the signal to master effect 2.

When IFX1–12 are configured in “Bus Select”, the send level to the master effect is set in “Send 1” and “Send 2” (8–2a), which comes after IFX1–12 in the signal chain.

MIDI “Send 1” can be controlled by CC#93, and “Send 2” can be controlled by CC#91.

IFX Patch

As noted above, Drum Kits can have different **Bus Select (IFX/Indiv.Out Assign)** settings for each key, as set on the GLOBAL 4–3b Voice Assign/Mixer page. Since the Drum Program shares the effects with the main Program, these routings may or may not make sense; for instance, while the Drum Program may have originally had a compressor in IFX1, the main Program may have a vocoder.

This group of parameters lets you re-direct the Drum Program’s individual **Bus Select** settings. Continuing from the above, if some of the keys were set to go to IFX1, you can route them to an unused IFX instead - maybe IFX9, for instance. Add a compressor in IFX9, and you’re now good to go.

See “Use Drum Kit Settings,” above, for notes on the typical routings for the factory Drum Kits.

This section appears only if **Use Drum Kit Settings** is **On**. Note also that if the Drum Kit doesn’t use routing to the IFX busses, these parameters will have no effect.

IFX1 [L/R, IFX1...12, 1...4, 1/2...3/4, Off]

This re-route the Drum Program sounds assigned to IFX1, and re-routes them to the selected bus.

IFX2...12 [L/R, IFX1...12, 1...4, 1/2...3/4, Off]

These work the same as “IFX1,” above.

Note: If you want to return the drum kit to its previous state, change these settings to IFX1=IFX1, IFX2=IFX2, and so on.

Scene1–4 Setup

Here we configure each of the arpeggiator and drum settings for each scene.

Arpeggio Pattern [P0...P4, A0000...A2047, B000...B127]

Selects the arpeggio pattern.

| Preset/User No | Contents |
|----------------|----------------------------------|
| P0...P4 | Preset arpeggio patterns |
| A0000...A2047 | Preloaded/User arpeggio patterns |
| B000...B127 | User arpeggio patterns |

Note: A0000–A2047 is also rewritable. Use GLOBAL> Arpeggio Pattern to create arpeggio patterns.

Example: Preset pattern

The way in which the pattern is played will depend on settings such as **Octave** and **Sort**. P0–P4 in the following diagrams show how the arpeggio will be played when Octave is set to 1, and Sort is checked. P4: RANDOM is only one possibility.

P0: UP

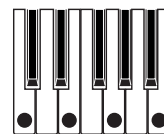

P1: DOWN

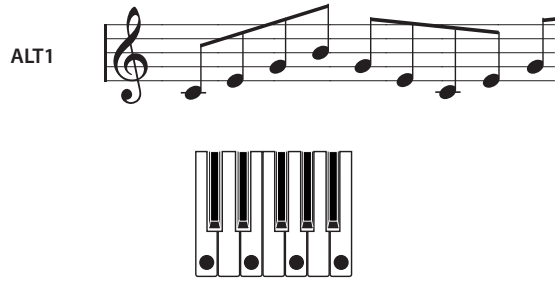
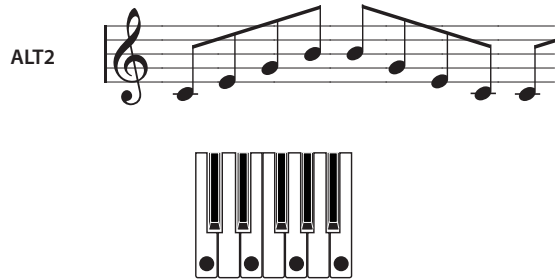
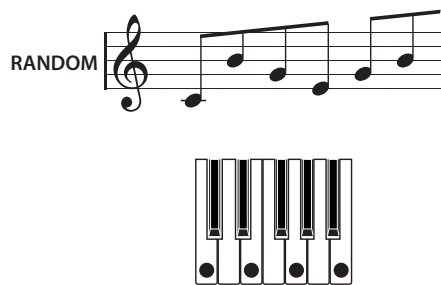

P2: ALT1**P3: ALT2****P4: RANDOM****Loop/1Shot**

This sets whether to make the arpeggio pattern repeat itself, or whether the pattern should play to the end and stop.

Loop: The arpeggio pattern will repeat while you are playing the keyboard or while Latch is enabled.

1Shot: The arpeggio pattern will play to the end and then stop, even while you are still playing the keyboard or while Latch is enabled.

Latch

Selects whether the Latch function is enabled for each arpeggiator.

Note: The latch will not operate while the Latch function itself is turned off, even if the latch settings in each arpeggiator are enabled.

Drum Track/StepSeq select

Selects the drums used by the scene, from the drum track or step sequencer A–D.

Drum Track Pattern

Selects the drum pattern.

You can write to patterns U000–U999. Patterns that you create in SEQUENCER mode can be converted into user drum patterns. See “Convert to Drum Track Pattern” on page 553 and the “Creating Drum Track patterns” on page 169 of the OG for how to create a user drum pattern.

More

Open the Scene 1–4 Setup detailed settings dialog box.

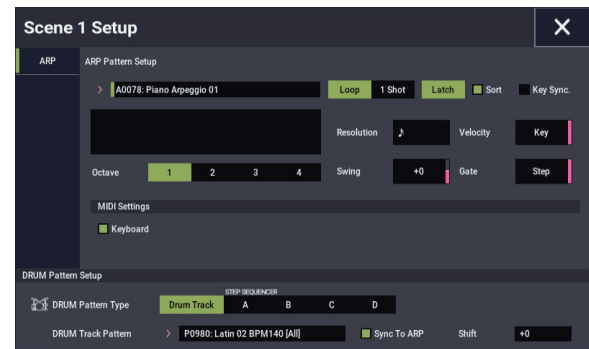
**Sort****[Off, On]**

This expands all of the notes (keys) that are played together into an arpeggio, and sets the order in which they sound.

On (checked): The arpeggio is played in order of scale tones, regardless of the order in which the note-on signals were played.

Off (unchecked): The arpeggio is played in the order in which the note-on signals occurred.

Key Sync.**[Off, On]**

This sets whether the arpeggio plays at the timing with which you play the keyboard, or whether the arpeggio always follows the “Tempo” setting.

On (checked): The arpeggiator will start playing from the beginning, starting with the first note-on that occurs after you’ve taken your hands completely off the keyboard. This works best when you are playing in real time, to match the timing of when the measure starts.

Off (unchecked): The arpeggiator will always follow the “Tempo” setting.

Arpeggio Pattern Preview

This shows the steps of the user arpeggio patterns as an image.

Octave**[1, 2, 3, 4]**

Specifies the range (in octaves) over which the arpeggiator notes sound.

When a user arpeggio pattern is selected, the way that the notes are distributed changes according to the “Octave Motion” settings.

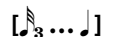
Resolution

This sets the resolution of the arpeggio.

The notes that the arpeggiator plays will be based around the value you set here. The speed of the arpeggio pattern is determined by the “Tempo” and “Resolution” settings.

Swing**[–100...+100(%)]**

Shifts the timing of the even-numbered arpeggiated notes, starting from the first note.

Velocity**[001...127, Key, Step]**

Specifies the velocity of the notes in the arpeggio.

001–127: Each note will sound with the specified velocity value.

Key: Each note will sound with the velocity value at which it was actually played.

Step: This is available when an user arpeggio pattern A0000-A2047/B000-B127 is selected for **Pattern**. When this is selected, the velocity specified for each step will be used.

Gate [000...100(%), Step]

Specifies the length (gate time) of each note in the arpeggio.

000–100(%): Each note will be played with the specified gate time.

Step: This is available when a user arpeggio pattern A0000-A2047/B000-B127 is selected for **Pattern**. When this is selected, the gate time specified for each step will be used.

Keyboard [Off, On]

This specifies whether the notes you play on the keyboard will be sounded as usual in addition to being sounded as part of the arpeggio.

On (checked): The notes you play will be sounded on their own, in addition to being sounded as part of the arpeggio.

For example if you simultaneously press two or more notes, they will be sounded as usual in addition to being played as arpeggiated notes.

Off (unchecked): Only the arpeggiated notes will be heard.

DRUM Pattern Setup:

Sync [Off, On]

To sync the playback of the drum track and arpeggiator (or sequencer), set “Sync” to “On”.

(Trigger Sync) On: The drum track will start with the trigger that starts the drum track falling in sync with the nearest beat played by the arpeggiator that is currently running. In SEQUENCER mode, the drum track pattern will start with the trigger falling in sync with the beginning of the nearest measure of the song, pattern or RPPR that’s currently playing.

Note: In SEQUENCER mode, when synchronizing the RPPR pattern to the drum track that is currently playing, set the “Sync” parameter to “Beat” or “Measure”.

(Trigger Sync) Off: When the “Trigger Mode” parameter is set to “Start Immediately”, the drum track pattern starts at the same time that the DRUM function is turned on. Also, when this parameter is set to “Wait KBD Trig”, the pattern starts right when you press a key. Note that when “Sync” is set to “Off”, the drum track pattern will not synchronize with the arpeggiator that is currently playing; and in SEQUENCER mode, the drum track pattern will not synchronize with the RPPR.

Shift [-24...+00...+24]

Sets the drum pattern in semitones. This will change the instruments used in the drum kit.

Edit STEP SEQUENCE

This is used to edit the step sequencer’s sequence.

The step sequencer features four sequences (A, B, C and D), and you can select and play one sequence for each scene.

Load Arpeggio Pattern

Loads the arpeggio pattern as a step sequence.

Note: Since any parameter settings that are not in the step sequence will be lost, the pattern will not be exactly the same when played back.

All Clear

Initializes the step sequencer.

Step Edit

This let you input phrases and set the tempo, beat and phrase length.

Meter [1/4~16/4.... 1/16...16/16]

Sets the beat (time signature) used by the step sequence.

Length [1...64]

Sets the length of the step sequence.

Resolution [♪₃ ... ♪]

Sets the resolution of the step sequence.

Accent [-64...+63]

This lets you change the amount of accent applied to steps that are set to be accented.

Values from +01 to +63 will increase the velocity of the steps whose accent is turned on.

Values from -01 to -64 will decrease the velocity of the steps whose accent is turned on.

Steps Per Beat (for Swing)

Sets the steps that will swing. Set the amount of swing using the “Swing” parameter of the RT Control Knob (0–6c).

x1: Swing will be applied to even-numbered steps (2, 4, 6, 8...).

x2: Swing will be applied to steps 3, 7, 11, 15 and numbers following this pattern.

x4: Swing will be applied to steps 5, 13, 21, 29 and numbers following this pattern.

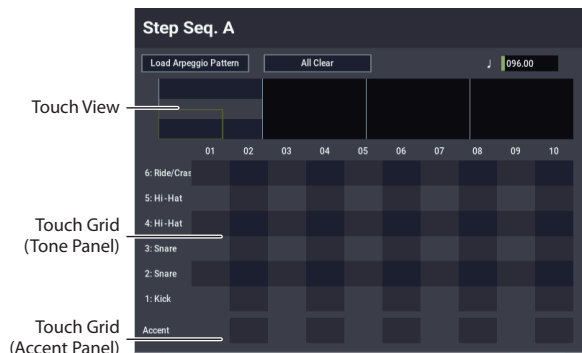

Touch View

Selects the display area of the Touch Grid.

Touch Grid

Tone Panel

Insert or delete tones by pressing somewhere on the Tone Panel (upper part of the matrix).

Accent Panel

Turn the accents of steps on/off using the Accent Panel (lower part of the matrix).

Inst. Edit

Selects the sound used by the step sequencer.



✓ 0-6: Page Menu Commands

- Compare →p.112
- Write Program →p.112
- Exclusive Solo →p.113
- Add To Set List →p.113
- Copy External Scene →p.122
- Copy Scene →p.122
- Swap Scene →p.122
- Initialize Scene →p.122
- PAGE →p.126
- MODE →p.126

0-8: Sampling



This page lets you adjust the volume, pan, effects sends, and busing for the audio inputs, including analog inputs 1 & 2, USB 1 & 2. It also controls the sampling-related settings for PROGRAM mode.

The NAUTILUS can sample external audio from any of the inputs, at 48 kHz 16-bit resolution (or 24-bit when sampling to drive), in mono or stereo. You can record samples into RAM for use in SAMPLING mode, or sample directly to drive.

You can also digitally resample the complete sound of a Program, played polyphonically, live or sequenced, including any effects, Arpeggiator function or drum track play.

Finally, you can also use the NAUTILUS as a 4-in, 6-out audio processor. You can process the inputs through the IFX, MFX, and TFX, or through the synthesis functions of EXi such as the MS-20EX and MOD-7.

You can combine any and all of these features at once. For instance, you can sample a live guitar riff from the audio inputs, processed through NAUTILUS effects, while listening to drum track play.

0-8a: Sampling Setup

Source Bus [Audio Input 1/2, USB 1/2, L/R, REC1/2...3/4, Indiv.1/2...3/4]

You can sample in stereo from any pair of audio inputs, from the two stereo REC busses, or from the signal at any of the 6 outputs (L/R and Individual 1/2-3/4).

When you sample from an output pair or REC bus, you'll record all audio sent to the output or bus, including internal Programs or Combis, effects, audio inputs, and HDR audio.

When sampling in stereo, the odd-numbered channel (such as 1 or 3) corresponds to the left channel, and the even-numbered channel (such as 2 or 4) corresponds to the right.

L/R: This lets you sample the signal heard at the main L/R outputs, including any processing by TFX 1/2. This is the default setting. For more information, see the diagram "Source Bus = L/R" on page 23.

REC1/2, REC3/4: These let you sample the signals sent to the REC 1/2 or REC 3/4 busses.

Using the REC busses, you can isolate one or more sounds for recording or sampling—even if the sounds are also being mixed into the main outputs. For example, you can play a guitar through NAUTILUS IFX while listening to an ARP drum phrase, and record the processed guitar without recording the drums.

Individual Programs, Combi Timbres, Sequencer Tracks (both MIDI and Audio), audio inputs, and Insert Effects can all be routed to the REC busses, in addition to their main output/IFX bus settings.

For more information, see the diagram "Source Bus = REC Bus 1/2" on page 23.

Audio Input 1/2, USB: These let you sample directly from the analog, or USB audio inputs, respectively, without any other processing by NAUTILUS. The settings on the Audio Inputs mixer, including volume, pan, busses, sends, mute, and solo, will have no effect on the recorded audio.

For more information, see the diagram "Source Bus = Audio Input 1/2" on page 23.

For more information, see the diagram "Source Bus = USB 1/2" on page 24.

Indiv.1/2...3/4: This lets you sample the individual output busses. For more information, see the diagram "Source Bus = Indiv. 1/2" on page 24.

Source Bus = L/R

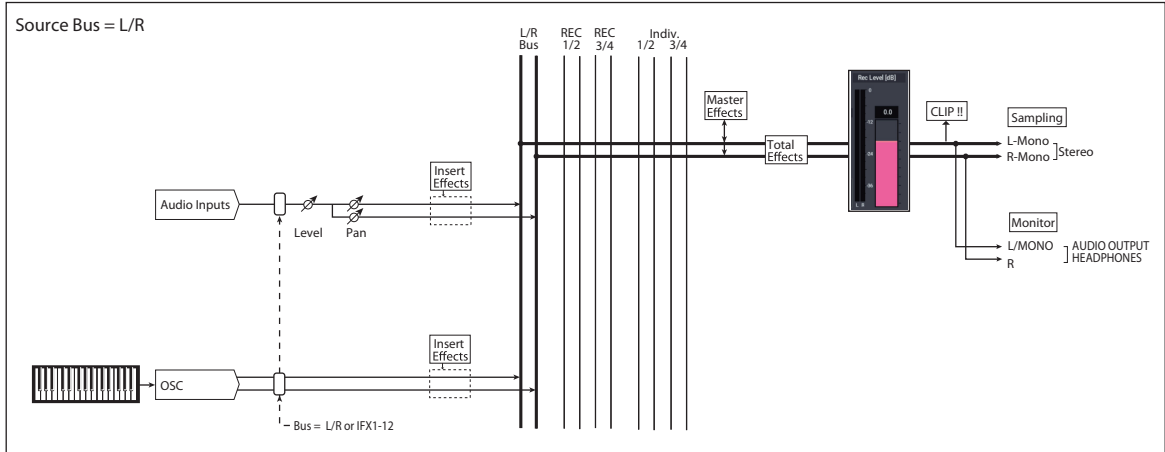

Source Bus = REC Bus 1/2

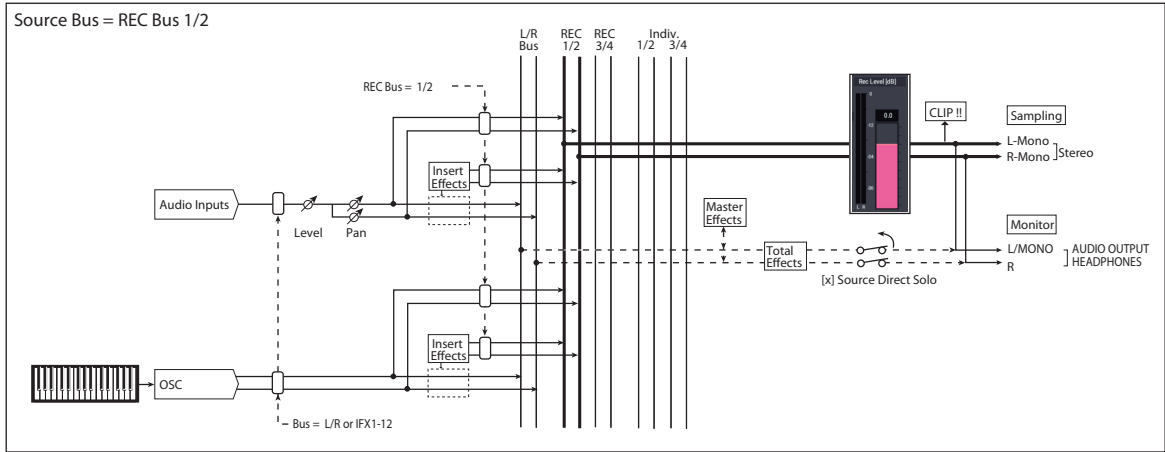

Source Bus = Audio Input 1/2

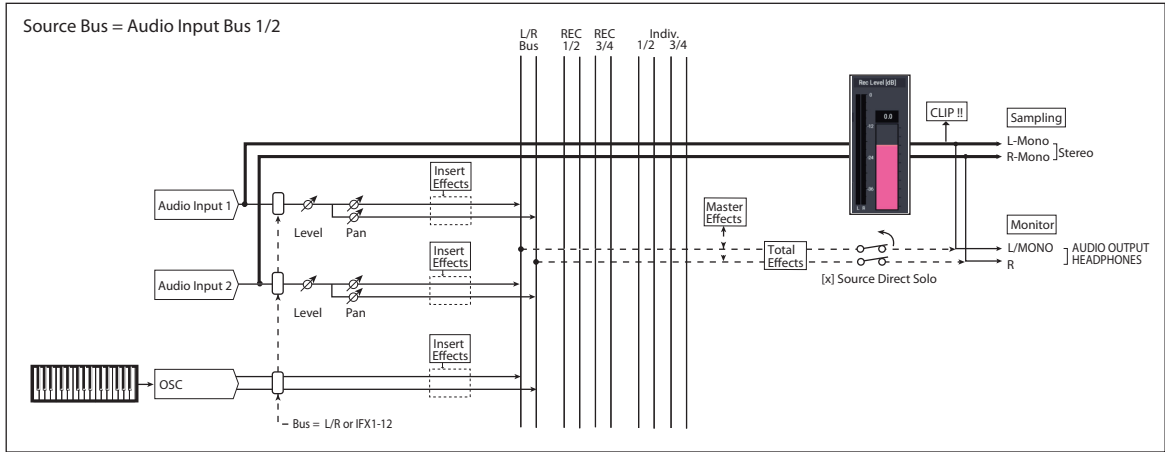

Source Bus = USB 1/2

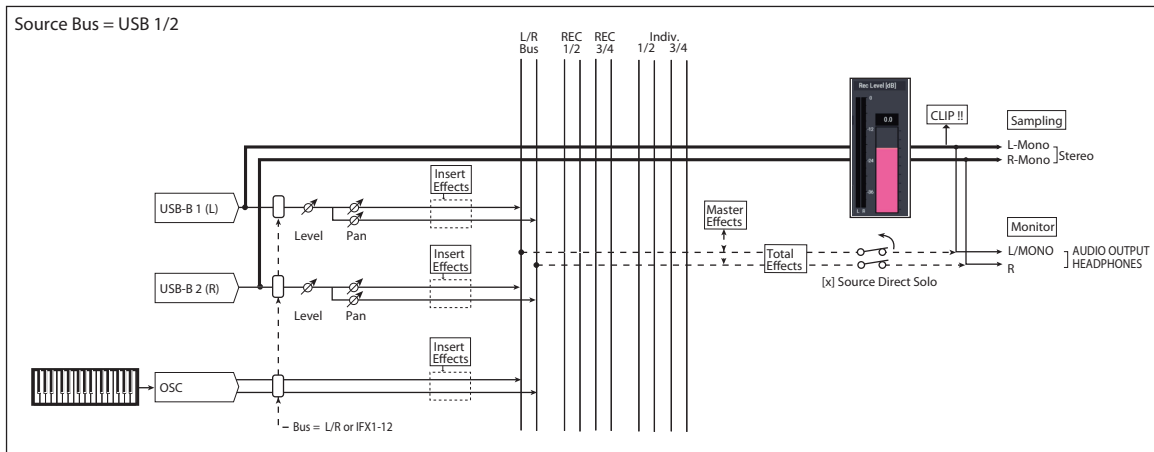

Source Bus = Indiv. 1/2

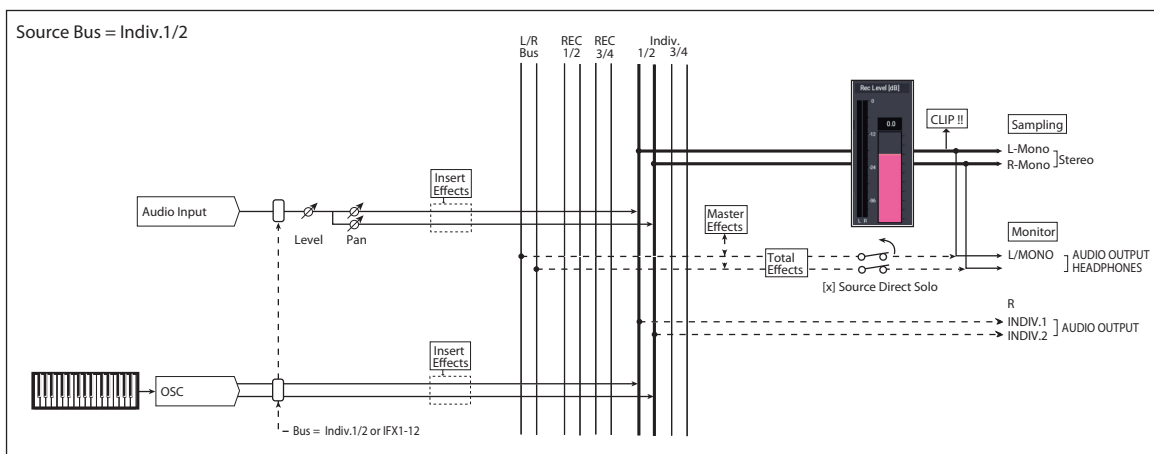

Source Direct Solo [Off, On]

This selects what is heard through the L/R outputs and headphones when Sampling REC is enabled.

On (checked): Only the signal of the selected **Source Bus** will be heard. This lets you hear only the sound that will be sampled.

Off (unchecked): The signal of the selected **Source Bus** will be merged with the main L/R signal. This is the default.

Note: If **Source Bus** is set to **L/R**, this setting is ignored—since that signal is normally heard at the L/R outputs already!

Trigger [Sampling START Button, Note On]

Specifies how sampling will be initiated.

Sampling START Button: Pressing the SAMPLING REC button will cause the NAUTILUS to enter sampling-standby mode, and sampling will begin when you press the SAMPLING START/STOP button.

Note On: Press the SAMPLING REC button and then press the SAMPLING START/STOP button to enter sampling-standby mode. Sampling will begin when you play the keyboard.

MIDI Sampling will also begin if a MIDI note-on is received (instead of playing the keyboard).

Regardless of the settings you’re using, press the SAMPLING START/STOP button once again when you’ve finished sampling. Alternatively, sampling will end automatically if the specified “Sampling Time” elapses.

Metronome Precount [Off, 4, 8, 3, 6]

This specifies whether the metronome will sound a count-down before sampling begins. This can be set only if “Trigger” is set to Sampling START button.

Off: Sampling will begin immediately when you press the SAMPLING START/STOP button from recording-standby mode.

4, 8, 3, 6: When you press the SAMPLING START/STOP button from recording-standby mode, the metronome will count the specified number of beats at the system tempo, and then sampling will begin. If you set this to 4, sampling will begin on the count of 0 after a pre-count of 4–3–2–1–0.

The output destination and level of the metronome sound are specified by Metronome Setup (0–8d). If “Output Bus” is set to L/R, the metronome will stop sounding the instant sampling actually begins.

Sample to Disk [16-bit, 24-bit]

This sets the bit depth for sampling to media. Note that this does not affect sampling to RAM. This same parameter appears on the sampling setup pages in Program, Combination, Sequencer, and SAMPLING modes; changes in one place are reflected everywhere.

The resulting 24-bit files can be used at full resolution in audio tracks. You can also load them into SAMPLING mode, at which time they will be automatically converted to 16-bit data.

Save to [RAM, Disk]

Specifies the destination to which the data will be written during sampling.

RAM: The sound will be sampled into RAM for use in SAMPLING mode. The **Select Sample No.** menu command lets you specify the Sample numbers to use, enable **Auto +12dB**, and make settings for automatic conversion to a Program. For more information, see “Select Sample No.” on page 115.

Note: The amount of RAM available for SAMPLING mode is shown by Free Sample Memory/Locations (SAMPLING 0–1f). The amount of RAM available will vary depending upon both the amount of physical RAM installed, and the size of the currently loaded EXs and User Sample Banks. For more information, see “Sampling and RAM” on page 571.

- ▲ Samples saved to RAM will be lost when the power is turned off, so you must save them if you want to keep them.

Disk: Samples will be recorded to the internal drive or a USB storage device.

When you sample, a WAVE file is created on the drive. Use the **Select Directory/File for Sample to Disk** page menu command to specify the writing-destination drive and directory.

To open the resulting sample, you can either use MEDIA mode to load the sample into SAMPLING mode, or use **Select Directory/File for Sample to Disk** to select the file and then press the Play button or the SAMPLING START/STOP button.

Sample Mode [L-Mono, R-Mono, Stereo]

Specifies the channel(s) that you want to sample, and specify whether a mono or stereo sample will be created.

The L and R channels of the bus specified by **Source Bus** (0–8c) will be sampled.

L-Mono: The left channel of the **Source Bus** will be sampled in mono.

R-Mono: The right channel of the **Source Bus** will be sampled in mono.

Stereo: The L and R channels of the bus specified by **Source Bus** will be sampled in stereo. This will create a stereo multisample and samples. For more information, see “About stereo multisamples and stereo samples” on page 576.

Sample Time [min] [sec]

This sets the amount of time that you wish to sample. This can be set in 0.001 second increments.

Immediately after the power is turned on, this parameter shows the maximum available sampling time, equivalent to the entire amount of free RAM. Each time you press STOP after sampling to RAM, the change in remaining sample time will be displayed automatically.

If **Save to** is set to Disk, the maximum value is determined by the free space on the current drive, as specified by the **Select Directory/File for Sample to Disk** menu command.

Tips: If you have sufficient RAM memory, it’s a good idea to set a generous amount of **Sample Time**. After you sample, you can then use the **Truncate** menu command to delete unwanted portions of the sample, and reduce it to the minimum size necessary. For more information, see “Truncate (for Sample Edit)” on page 613 and “Truncate (for Loop Edit)” on page 620.

You can also press the SAMPLING START/STOP button to manually stop sampling after you have recorded the desired material. For more details on sampling, see “Preparations for sampling” on page 126 of the OG.

- ▲ If **Save to** is set to **RAM** and **Auto Optimize RAM** is not enabled, recording and editing multiple samples may cause wasted space to accumulate in memory, decreasing the amount of available RAM. In this case, use the **Optimize RAM** menu command to recover the wasted space. For more information, see “Auto Optimize RAM” on page 635 and “Optimize RAM” on page 114.

Note: “Free Sample Memory/Locations” (SAMPLING 0–1f) in SAMPLING mode lets you check the remaining amount of RAM.

Note: The various Recording Setup settings are not made independently for each program; they apply to the entire PROGRAM mode.

0-8b: Audio Input



Use Global setting [Off, On]

Each Program can either use the single, Global audio input mixer setup, or have its own custom settings. The Global settings are described under “0-2: Audio,” on page 637.

When **Use Global Settings** is **On**, the Program uses the Global settings. This is the default, and lets you change freely between different Programs, Combis, and Songs without affecting the audio inputs.

Also, any edits made on this page will affect the Global setting, along with any other Programs, Combis, or Songs which use the Global setting.

On the other hand, it may sometimes be convenient to save a particular mixer setup with an individual Program, Combi, or Song, to set up special sub-mixer settings or effects processing for particular inputs. For example, you can set up a Program to use a mic input with a vocoder, as described under “Vocoder (PROGRAM mode)” on page 736.

In this case, set **Use/Edit Global Setup** to **Off**, and the audio inputs will use the Program’s custom settings.

Input1 & 2

These are settings for the analog inputs.

USB1 & 2

These are settings for the USB inputs.

Bus Select (IFX/Indiv.) [L/R, IFX1...12, 1...4, 1/2...3/4, Off]

This sets the output bus for the external audio input signal. You can send the audio directly to physical outputs, or to the insert effects.

Audio input/output

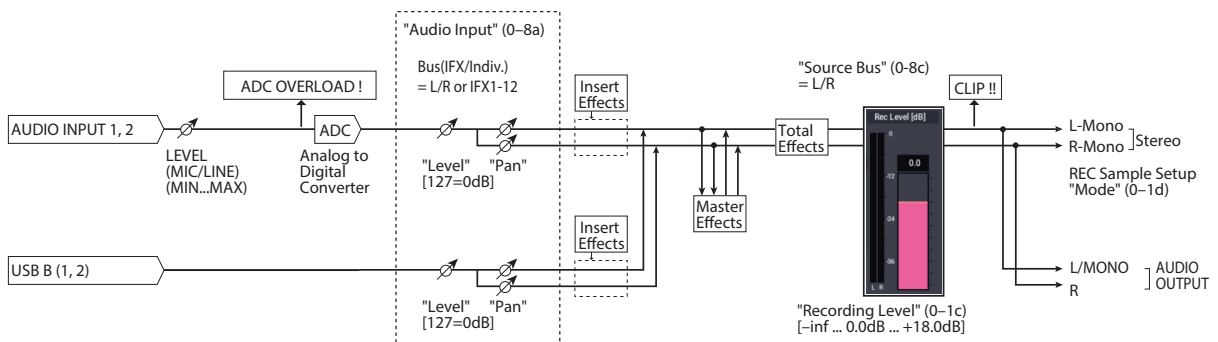

L/R: The external audio input signal will be sent to the L/R bus.

IFX1...12: The external audio input signal will be sent to the IFX1–12 bus. Choose one of these settings if you want to apply an insert effect while sampling.

1...4: The external audio input signal will be sent in mono to INDIVIDUAL outputs 1-4. Pan does not apply in this case.

1/2...3/4: The external audio input signal will be sent to the selected pair of outputs in stereo, with the stereo position controlled by the **Pan** parameter

Off: The external audio signal will not be used.

FX Ctrl Bus (FX Control Bus) [Off, 1, 2]

This lets you send the audio input to one of the two stereo FX Control buses. See “FX Control Buses” on page 735.

REC Bus [Off, 1...4, 1/2, 3/4]

This sends the external audio input signal to the REC busses (four mono channels; 1, 2, 3, 4).

Using the REC busses, you can isolate one or more sounds for recording or sampling—even if the sounds are also being mixed into the main outputs. For example, you can play a guitar through NAUTILUS IFX while listening to a ARP drum phrase, and record the processed guitar without recording the drums.

Individual Programs, Combi Timbres, Sequencer Tracks (both MIDI and Audio), audio inputs, and Insert Effects can all be routed to the REC busses, in addition to their main output/IFX bus settings.

You can sample these signals by setting the sampling **Source Bus** (0-8c) to REC bus.

For more information, see the diagram “Source Bus = REC Bus 1/2” on page 23.

Off: The external audio signal will not be sent to the REC busses. Normally you will use the Off setting.

1, 2, 3, 4: The external audio input signal will be sent to the specified REC bus. The **Pan** setting is ignored, and the signal is sent in monaural.

1/2, 3/4: The external audio input signal will be sent in stereo to the specified pair of REC busses. The **Pan** setting sends the signal in stereo to busses 1 and 2 or busses 3 and 4.

Send1 (to MFX1) [000...127]

Send2 (to MFX2) [000...127]

These adjust the levels at which the external audio input signal is sent to the master effects.

Send1 (to MFX1): Send the signal to master effect 1.

Send2 (to MFX2): Send the signal to master effect 2.

If **Bus Select (IFX/Indiv. Out Assign)** is set to IFX1–12, the send levels to the master effects are set by the post-IFX1–12 **Send1** and **Send2** (8–2a). For more information, see “Analog, and USB inputs” on page 747.

Mute [Off, On]

Turns on/off mute for the external audio signal being inputted.

On: The input sound will be muted (silent).

Off: The input sound will be heard.

Solo [Off, On]

Turns on/off Solo for the external audio signal being inputted. It does this by temporarily muting all non-soloed Oscillators and audio inputs.

The way in which Solo operates depends on the setting of the **Exclusive Solo** menu command.

 The Solo setting is not stored when you Write a Program.

Pan [L000...C064...R127]

This specifies the panning of the audio input. When using two inputs for a stereo audio source, you’ll normally set the inputs to L000 and R127 respectively.

Level [000...127]

This controls the level of the external audio signal. The default is 127.

The meter to the left of the slider shows the audio input volume, before the Level control, in realtime.

The analog audio signals from AUDIO INPUTS 1–2 are converted into digital form by an A/D converter. This parameter sets the level of the signal immediately after this conversion.

If the sound is distorted even though this level setting is very low, see “Tips for eliminating distortion when using the analog inputs,” below.

Avoiding extraneous noise

 If audio cables are connected to AUDIO INPUTS 1–2, any noise carried by the cables will enter into the NAUTILUS mixer structure. This may include hiss, hum, and other audio noise.

To avoid noise from unused audio inputs, either:

- Set the input’s **Level** to 0
- or
- Set all of the bus assignments to Off, including **Bus Select (IFX/Indiv. Out Assign)**, **REC Bus**, and **FX Control Bus**

If no audio cables are connected to AUDIO INPUTS 1–2, the input signals are forced to zero, preventing any additional noise.

0–8c: Rec Level [dB]

ADC OVERLOAD!

If the signal level from the analog audio inputs is too high, the “ADC OVERLOAD!” indication will appear. You’ll need to adjust Audio Input Setup, or the output level of your external audio source.

Recording Level [–Inf, –72.0...+0.0...+18.0]

This adjusts the signal level at the final stage of sampling.

The Recording Level setting is made for PROGRAM mode as a whole, and is not saved independently with each Program.

Level Meter

This shows the signal level at the final stage of sampling, after any adjustments on the Audio Inputs page, any effects, etc. The meter is active only during standby mode and recording.

CLIP!

If 0 dB is exceeded, the display will indicate “CLIP!” This means that the level of the sampling signal is too high; in this case, adjust the Recording Level, and if necessary follow the instructions under “Tips for eliminating distortion when using the analog inputs,” below.

Setting levels

For the best results, set the levels as described below:

1. Press the SAMPLING REC button.

NAUTILUS will enter sampling standby mode, and the **Level Meter** becomes active.

2. Initially, set the Rec Level [dB] to 0.0dB.

3. Adjust the level of the input signal so that it is as high as possible without activating the CLIP! or ADC OVERLOAD! messages.

If you’re using AUDIO INPUTS 1 and/or 2, adjust the volume by Analog Input Setting.

If you’re using AUDIO INPUT 3 and/or 4, adjust the output level of your external audio source.

If you’re sampling external audio through the internal effects, you may also need to adjust the individual effects input and/or output level parameters.

If you’re using internal sounds, adjust the levels using the effects input/output trim, etc.

4. If the level is still not high enough, increase the Recording Level using the on-screen slider.

Again, the goal is to get the level as high as possible without activating the CLIP! or ADC OVERLOAD! messages.

Tips for eliminating distortion when using the analog inputs

If sound from the analog inputs is distorted, but the CLIP! message doesn’t appear, it’s possible that distortion is occurring at the analog input stage, or that distortion is being caused by the settings of the internal effects.

If the “ADC OVERLOAD!” message appears above the **Recording Level** meters, the distortion is due to excessive levels at the input. In this case, either lower the output level of the external audio source, or adjust Audio Input Setting so that this message does not appear.

If there is distortion, but the “ADC OVERLOAD!” message does not appear, it’s possible that the distortion is being caused by the settings of the internal effects. To solve this problem, either lower the input **Level** (see “Level,” above), or adjust the effects settings (such as changing the individual effect Input Trim parameters).

0–8d: Metronome Setup

Here you can specify the output destination and volume of the metronome, as set up in by “Metronome Precount” (0–2c). The metronome is available only if “Trigger” is set to Sampling START button.

Output Bus **[L/R, L, R, 1...4]**

This sets the audio output for the metronome sound.

L/R: The metronome will be heard in the main stereo outputs (L/Mono and R), USB, and the headphones.

1...4: The metronome will be heard only in the selected individual output.

Level **[000...127]**

This controls the volume of the metronome sound.

0–8e: Analog Input Setup

Audio In **[Button]**

Switches the audio input on/off. This works in tandem with the AUDIO IN button on the front panel.

Press the Setup button to display the Analog Input Setup dialog box.

Analog Input Setup dialog

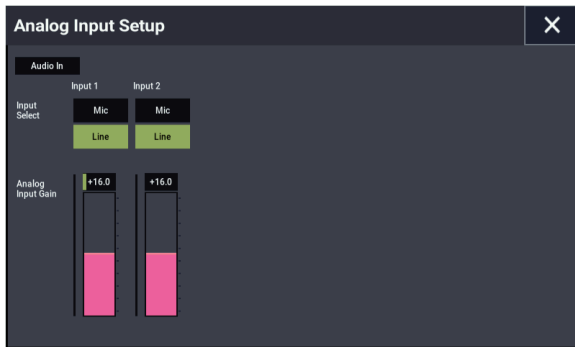

Input Select

Sets the specified level of the input signal. Switch this to match the device that is connected, and use Analog Input Gain to adjust the gain.

LINE: Set this to “LINE” when you want to connect a mixer, computer, audio system, signal processor or another synthesizer. The specified level is +4 dBu, with 12 dB of headroom.

MIC: Use the “MIC” setting if you are connecting a mic.

Analog Input Gain

Use this to fine-tune the gain after setting the gain in “Input Select”.

When Input Select is set to “LINE”, the “MIN” position equals unity gain.

The MAX position is about 40 dB higher than the MIN setting.

Auto Sampling Setup

This command automatically configures the PROGRAM mode sampling-related parameters, making it easy for you to sample an external audio source or to resample your performance as you play a Program. You can also use this command to initialize the sampling settings. For more information, see “Auto Sampling Setup” on page 116.

0–8f: Sampling button

Press the button to enter sampling standby.

To begin sampling, press the SAMPLING START/STOP button.

SAMPLING START/STOP

When you press this button after pressing the SAMPLING REC button, one of the following will occur depending on the “Trigger” settings.

- When “Trigger” is set to “Sampling START Button”, pressing this button will immediately begin sampling.
- When “Trigger” is set to “Note On”, sampling begins after you press this button and then play a key (note on) on the keyboard.
- When “Trigger” is set to “Threshold”, sampling begins after you press this button and the threshold level is reached for the audio source.

Press this button on the Sample Edit page in SAMPLING mode to play back the selected sample.

✓ 0–8: Page Menu Commands

- Compare →p.112
- Write Program →p.112
- Exclusive Solo →p.113
- Optimize RAM →p.114
- Select Sample No. →p.115
- Auto Sampling Setup →p.116
- Add To Set List →p.113
- PAGE →p.126
- MODE →p.126

0-9: Tone Adjust

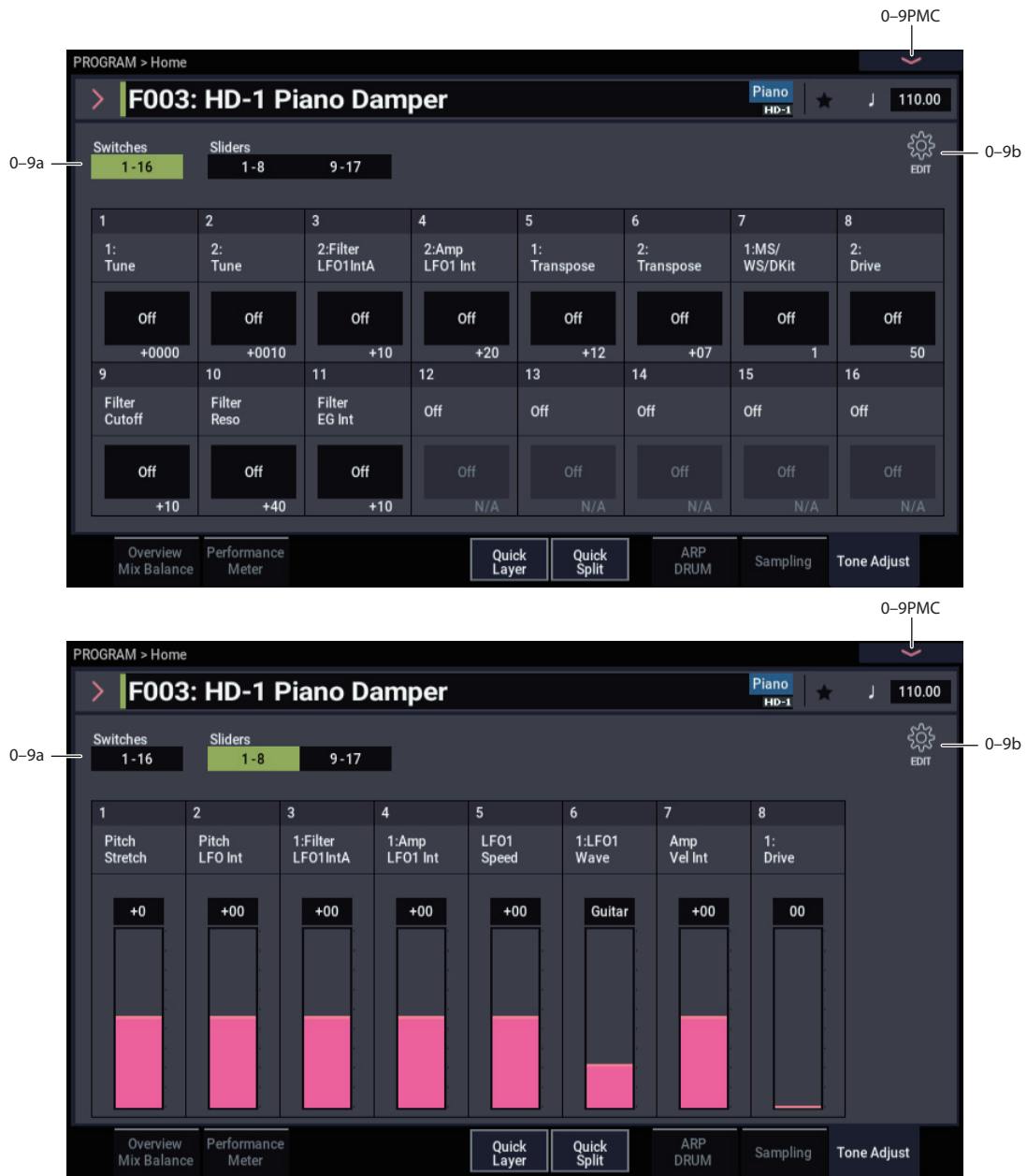

0-9a: Tone Adjust

The Tone Adjust function lets you edit the parameters of a program like an analog synthesizer, by using the switches and sliders shown in the display. Tone Adjust switch and slider can be assigned to any one of a number of Program parameters.

Each controller can be assigned to only one parameter, and each parameter can be assigned to only one controller.

To swap a parameter from one control to another, you'll need to first un-assign it from the old control, and then assign it to the new control.

Tip: In COMBINATION and SEQUENCER modes, Tone Adjust also lets you edit Program parameters without needing to save a different version of the original Program. For more information on Tone Adjust in these modes, see "0-9a: Tone Adjust" on page 394.

Switches 1-16 button

Switches to the Switch page of Tone Adjust.

Sliders 1-8, 9-17 buttons

Switches to the Slider page of Tone Adjust.

Saving Tone Adjust Edits

Tone Adjust edits are saved in two different ways, depending on whether the parameter is **Relative** or **Absolute**. (For more information, see "Absolute, Relative, and Meta parameters," below.)

Edits to **Relative** parameters affect the sound immediately, but don't change the underlying Program parameter settings until the Program is saved. When the Program is saved, the NAUTILUS calculates the combined effects of Tone Adjust and dedicated CC modulation (from the RT Control Knobs,

for instance), and saves the results into the Program parameters directly. At that point, all of the Relative parameters are reset to 0.

Edits to **Absolute** parameters are immediately reflected in the corresponding on-screen parameters, and vice-versa.

Tone Adjust and MIDI SysEx

The Tone Adjust sliders, and switches all send and receive MIDI System Exclusive messages. You can use this to record and play back Tone Adjust edits with a sequencer, including the built-in sequencer.

Note: The SysEx messages are tied to the physical controls, and not to the functions to which they are assigned. For instance, let’s say that slider 1 is assigned to control Filter Resonance, and move slider 1 while recording into a sequencer. The sequencer will record that slider 1 has moved, and not that Filter Resonance has changed. If you later change slider 1 to control LFO1 Speed, playing back the sequence will affect the LFO, and not Filter Resonance.

Interaction between Tone Adjust and MIDI CCs

A number of the Common Tone Adjust parameters affect parameters which are also modulated by dedicated MIDI CCs. The specific CC numbers are noted in the descriptions for the individual Tone Adjust parameters, below.

Tone Adjust and the CCs work separately. It’s possible, for instance, for Tone Adjust to reduce the value of a parameter, and then for a CC to increase it again.

Tone Adjust scales the parameter first, and then the CC scales the result of the Tone Adjust.

Absolute, Relative, and Meta parameters

There are three kinds of Tone Adjust parameters: Absolute, Relative, and Meta.

For more on the types of each parameter, see “Common Tone Adjust Parameters” on page 31 and “HD-1 Tone Adjust Parameters” on page 32.

Absolute parameters usually control a single Program parameter, such as **Oscillator 1 Transpose**. The Program and Tone Adjust parameters mirror one another; when you change one, the other will change to match.

Relative parameters typically adjust two or more Program parameters simultaneously. For instance, **Filter/Amp EG Attack Time** affects a total of six Program parameters. The value of the Relative parameter shows the amount of change to these underlying Program parameters.

When the Relative parameter is at 0, the underlying Program parameters are unchanged.

The meanings of higher and lower settings can vary, depending on the specific parameter. Unless noted otherwise, they work as follows:

When the Relative parameter is at +99 (the maximum), the Program parameters are all at their maximum as well. Similarly, when the Relative parameter is at -99 (the minimum), the Program parameters are at zero.

Relative Tone Adjust parameter scaling

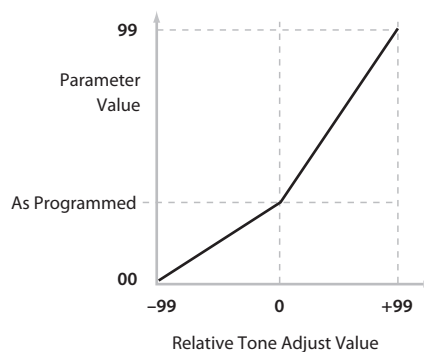

A few of the Program parameters controlled by Relative Tone Adjust are bipolar, meaning that they can be either positive or negative (instead of just positive). When these Program parameters are set to negative values, Tone Adjust may behave differently from the description above.

For instance, if EG Intensity is set to a negative value, Relative Tone Adjust will take it from 0 to -99, like the inverse of the diagram above. EG Sustain works differently; if it’s set to a negative value, Tone Adjust takes it from 0 down to the programmed value, and then up to +99, as shown below.

Relative Tone Adjust parameter scaling: EG Sustain

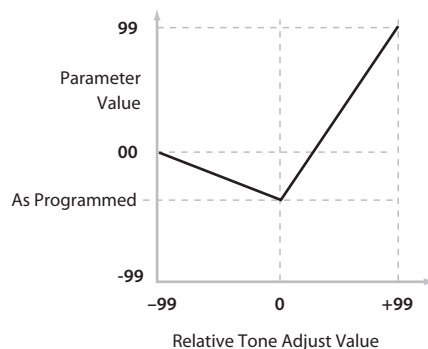

Meta parameters don’t affect Program parameters directly. Instead, they affect the way that other Tone Adjust parameters work. For instance, **Multisample Min #** and **Max #** set the minimum and maximum values of the Tone Adjust **Multisample** parameter.

0-9b: Tone Adjust Edit

Press the  (EDIT) icon to edit the assignments and other settings for the Tone Adjust function.

Switches 1-16

Set the operation of switches 1-16 in the Tone Adjust function.

When a switch is assigned to a **Relative** parameter, or an **Absolute** parameter with more than two states:

Switch On = **On Value** (see below)

Switch Off = the Program's stored value

When a switch is assigned to a two-state **Absolute** parameter, such as **Hold**, the switch status directly reflects the parameter value:

Switch On = **On**

Switch Off = **Off**

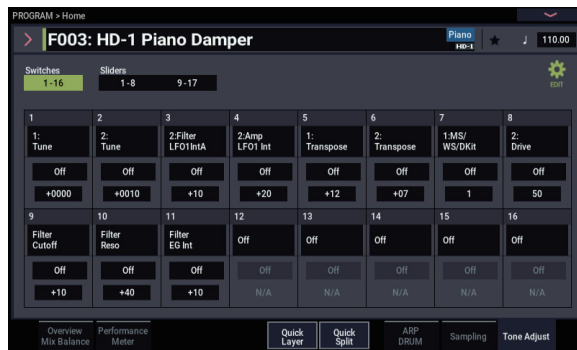

Assign [List of Tone Adjust assignments]

This lets you assign a Tone Adjust parameter to the switch. For a full list of the available choices, please see “Common Tone Adjust Parameters” and “HD-1 Tone Adjust Parameters,” below.

On Value [Depends on parameter]

The parameter is set to this value when the switch is On.

When the switch is assigned to a two-state **Absolute** parameter, such as **Hold**, this will always be the same as the **Switch Status** (see below).

Switch Status [Off, On]

This simply shows whether the switch is On or Off. The status is also shown by the LEDs in the physical buttons.

Sliders 1-8, 9-17

Assign [List of Tone Adjust assignments]

This lets you assign a Tone Adjust parameter to the slider. For a full list of the available choices, please see “Common Tone Adjust Parameters” and “HD-1 Tone Adjust Parameters,” below.

Per-Oscillator parameters apply to OSC1 and 2 individually, and are marked as such: [OSC1] and [OSC2].

Each controller can be assigned to only one parameter, and each parameter can be assigned to only one controller.

To swap a parameter from one control to another, you'll need to first un-assign it from the old control, and then assign it to the new control.

Value [Depends on parameter]

This shows the current value of the parameter. The range of values will vary depending on the parameter assigned to the slider.

Common Tone Adjust Parameters

These parameters affect both Oscillators 1 and 2.

Unless otherwise noted, all of the Common Tone Adjust parameters are **Relative**.

Off. This means that the Tone Adjust control has no effect.

Filter Cutoff. (-99...+99, CC#74)

This scales the cutoff frequency of all of the filters at once. For instance, in the HD-1, it affects both Filters A and B.

Filter Resonance. (-99...+99, CC#71)

This scales the resonance of all of the filters at once. For instance, in the HD-1, it affects both Filters A and B.

Filter EG Intensity. (-99...+99, CC#79)

This scales the effect of the Filter EG on the cutoff frequency. It affects all of the filters at once; for instance, in the HD-1, it affects both Filters A and B.

-99 means no modulation. +99 means maximum modulation in the same direction, positive or negative, as the original Program. For instance, if the original Program's EG Intensity was set to -25, then setting the Tone Adjust to +99 moves the EG Intensity to -99.

Amp Velocity Intensity. (-99...+99)

This scales the effect of velocity on the Amp level.

-99 removes the velocity modulation entirely. +99 means maximum modulation in the same direction, positive or negative, as the original Program.

Filter/Amp EG Attack Time. (-99...+99, CC#73)

This scales the attack times of the Filter and Amp EGs, along with other related parameters.

When the value is +1 or more, this also affects the Amp EG's Start and Attack Levels, Start Level AMS, and Attack Time AMS, as described below:

Between values of +1 and +25, the Start Level, Start Level AMS, and Attack Time AMS will change from their programmed values to 0. Over the same range, the Attack Level will change from its programmed value to 99.

Filter/Amp EG Decay Time. (-99...+99, CC#75)

This scales the decay and slope times of the Filter and Amp EGs. It interacts with CC# 75.

Filter/Amp EG Sustain Level. (-99...+99, CC#70)

This scales the sustain levels of the Filter and Amp EGs.

Filter/Amp EG Release Time. (-99...+99, CC#72)

This scales the release times of the Filter and Amp EGs.

Filter EG Attack Time. (-99...+99)

This scales the attack times of the Filter EGs.

Filter EG Decay Time. (-99...+99)

This scales the decay and slope times of the Filter EGs.

Filter EG Sustain Level. (-99...+99)

This scales the sustain levels of the Filter EGs.

Filter EG Release Time. (-99...+99)

This scales the release times of the Filter EGs.

Amp EG Attack Time. (-99...+99)

This scales the attack times of the Amp EGs.

Amp EG Decay Time. (-99...+99)

This scales the decay and slope times of the Amp EGs.

Amp EG Sustain Level. (-99...+99)

This scales the sustain levels of the Amp EGs.

Amp EG Release Time. (-99...+99)

This scales the release times of the Amp EGs.

Pitch EG Attack Time. (-99...+99)

This scales the attack times of the Pitch EG (or EGs, in the case of some EXi instruments).

Pitch EG Decay Time. (-99...+99)

This scales the decay and slope times of the Pitch EG (or EGs, in the case of some EXi instruments).

Pitch EG Sustain Level. (-99...+99)

This scales the sustain levels of the Pitch EG (or EGs, in the case of some EXi instruments).

Note: This does not apply to the HD-1.

Pitch EG Release Time. (-99...+99)

This scales the release times of the Pitch EG (or EGs, in the case of some EXi instruments).

Pitch LFO1 Intensity. (-99...+99, CC#77)

This scales the effect of LFO1 on the Pitch.

-99 removes the LFO modulation entirely. +99 means maximum modulation in the same direction, positive or negative, as the original Program.

LFO1 Speed. (-99...+99, CC#76)

This scales LFO1's frequency. When the LFO is in MIDI/Tempo mode, this adjusts the Base Note. For more information, please see "Frequency" on page 84.

LFO1 Fade. (-99...+99)

This scales LFO1's fade-in time. For more information, please see "Fade" on page 85.

LFO1 Delay. (-99...+99, CC#78)

This scales LFO1's delay time - the time between note-on and the onset of the LFO. For more information, please see "Delay" on page 85.

This parameter interacts with CC# 78.

LFO1 Stop. (PROG/Off/On, Absolute)

This **Absolute** parameter controls whether LFO1 is stopped or running. For more information, please see "Stop" on page 84.

The **PROG** setting restores the Program's original values—convenient if Oscillator 1's LFO was stopped, but Oscillator 2's was not.

LFO2 Speed. (-99...+99)

This scales LFO2's frequency. When the LFO is in MIDI/Tempo mode, this adjusts the Base Note. For more information, please see "Frequency" on page 84.

LFO2 Fade. (-99...+99)

This scales LFO2's fade-in time. For more information, please see "Fade" on page 85.

LFO2 Delay. (-99...+99)

This scales LFO2's delay time - the time between note-on and the onset of the LFO. For more information, please see "Delay" on page 85.

LFO2 Stop. (PROG/Off/On, Absolute)

This **Absolute** parameter controls whether LFO2 is stopped or running. For more information, please see "Stop" on page 84.

Common LFO Speed. (-99...+99)

This scales the Common LFO's frequency. When the LFO is in MIDI/Tempo mode, this adjusts the Base Note.

Unison. (Off/On, Absolute)

This **Absolute** parameter turns **Unison** on and off. For more information, please see "Unison" on page 37.

Number Of Voices. (2...16, Absolute)

This **Absolute** parameter sets the number of Unison voices. If **Unison** is not **On**, this parameter has no effect. For more information, please see "Number of voices" on page 37.

Detune. (0.0...200.0, Absolute)

This **Absolute** parameter sets amount of detuning between the Unison voices. If **Unison** is not **On**, this parameter has no effect. For more information, please see "Detune" on page 37.

Thickness. (Off/01...09, Absolute)

This **Absolute** parameter sets the pattern of detuning between the Unison voices. If **Unison** is not **On**, or if **Detune** is set to **0**, this parameter has no effect. For more information, please see "Thickness" on page 37.

Common Step Sequencer Attack Smoothing. (00...99, Absolute)

This **Absolute** parameter sets amount of attack smoothing for the Common Step Sequencer. Note that this applies only to EXi Programs. For more information, please see "Smoothing" on page 137.

Common Step Sequencer Decay Smoothing. (00...99, Absolute)

This **Absolute** parameter sets amount of decay smoothing for the Common Step Sequencer. Note that this applies only to EXi Programs. For more information, please see "Smoothing" on page 137.

HD-1 Tone Adjust Parameters**Macro parameters**

The following three parameters affect both Oscillator 1 and Oscillator 2.

* In the list below, the items in parentheses are (value range, edit type) respectively.

Pitch Stretch. (-12...+12, Relative)

This special control increases the Oscillator **Tune** parameter while lowering the **Transpose** parameter. The result is that the pitch stays the same, but the mapping of the samples to the keys changes. You can use this to create interesting shifts in timbre.

Hold. (Off/On, Absolute)

This lets you turn Hold on and off. For more information on this parameter, see "Hold" on page 38.

Reverse. (PROG/Off/On, Absolute)

This provides a quick way to turn Reverse on or off for all Multisamples in both Oscillators. **PROG** restores the Program's original settings—convenient if some Multisamples had been set to Off, and others set to On.

Per-Oscillator parameters

These parameters affect each Oscillator separately. In the list, the parameters for Oscillator 1 appear first, with each name prefaced by [OSC1]; the parameters for Oscillator 2 appear next, prefaced by [OSC2].

* In the list below, the items in parentheses are (value range, edit type) respectively.

Tune. (–1200...+1200, Relative)

This **Relative** parameter adds to or subtracts from the Oscillator’s Tune setting, as described under “Tune” on page 50.

Note: As with **Transpose**, below, this is a simple addition or subtraction, as opposed to the more complex “scaling” function.

Transpose. (–60...+60, Relative)

This **Relative** parameter adds to or subtracts from the Oscillator’s Transpose setting, as described under “Transpose” on page 50.

MS/WS/DKit Select. (PROG/0...16383, Absolute)

This lets you select a new Multisample or Wave Sequence for the Oscillator (in Single or Double Programs), or a different Drum Kit (in Drum Programs). You can either use this to select different sounds via a knob or slider—for instance, to select one out of a set of synth wavetables—or to override Program settings in a Combination or Song.

PROG restores the Program’s original Multisamples, Wave Sequences, or Drum Kits, including all velocity ranges and **Reverse** and **Start Offset** settings.

The list of Multisamples, Wave Sequences, or Drum Kits can be quite long. The sliders will let you sweep through the entire range, but it may not be possible to select all of the intermediate values. You can always select a specific value by editing the on-screen parameter via the standard data entry controls, such as the + and – buttons.

You can also limit the range of the control by using the **Min #** and **Max #** parameters, described below.

For Single and Double Programs:

- **MS/WS/DKit Select** overrides all of the Multisample Velocity zones, so that the newly selected Multisample or Wave Sequence plays over the entire velocity range.
- By default, if the original Program’s MS1 is a Multisample, you can select Multisamples; if MS1 is a Wave Sequence, you can select Wave Sequences. You can use the **MS/WS Type** parameter, described below, to change between Multisamples and Wave Sequences as desired.

For Multisamples only:

- By default, you can select from the same Bank as the original Program’s MS1. To select a different Bank, use the **MS Bank** parameter described below. (Note that **MS Bank** cannot be used to change to User Sample Banks or EXs numbered 126 and higher.)
- You can use the Tone Adjust **Reverse** and **Start Offset** parameters to modify the newly selected Multisample. By default, **Reverse** is set to **Off**, and **Start Offset** is set to **0**.

For Wave Sequences and Drum Kits:

- Wave Sequence and Drum Kit Banks are ignored; all items in all banks are available in a continuous list via the **Select** parameter.

MS/WS Type. (Off/MS/WavSeq, Meta)

This Meta-parameter modifies the **MS/WS Select** parameter, so that you can specifically choose to select either Multisamples or Wave Sequences.

If the **Select** parameter is not used, or if the current sound is a Drum Program, **MS/WS Type** has no effect.

MS Bank. (ROM mono/stereo, Smp:Old RAM mono/stereo, EXs1 mono...EXs125 stereo, Meta)

This Meta-parameter modifies the **MS/WS/Dkit Select** parameter, so that you can choose Multisamples from a Bank other than the one selected in the Program. You cannot use **MS Bank** to change to User Sample Banks or EXs numbered 126 and higher.

If the **Select** parameter is not used, this setting has no effect. **MS Bank** does not apply to Wave Sequences and Drum Kits, as described above.

MS/WS/DKit Min #. (0...16383, Meta)

This Meta-parameter sets a minimum value for the **MS/WS/Dkit Select** parameter. You can use this in conjunction with the **MS/WS/DKit Max #** parameter, below, so that a slider selects only from a small set of choices. This is particularly convenient with the internal ROM, in which similar Multisamples are grouped together. For instance, this makes it easy to select between a group of bells, or a set of electric basses.

If the **Select** parameter is not used, this setting has no effect.

MS/WS/DKit Max #. (0...16383, Meta)

This Meta-parameter sets a maximum value for the **MS/WS/Dkit Select** parameter. Please see **MS/WS/DKit Min #**, above, for more information.

Start Offset. (0...8, Absolute)

This allows you to change the Start Offset of the Multisample specified by the **MS/WS Select** parameter. It applies only when:

- The Program is a Single or Double (not a Drum Kit)
- The **MS/WS Select** parameter is used to select a Multisample (not a Wave Sequence)

For more information on Start Offsets, see “Start Offset” on page 52.

Drive. (0...99, Absolute)

This controls the Oscillator’s **Drive** parameter, as described under “Drive” on page 74.

Low Boost. (0...99, Absolute)

This controls the Oscillator’s **Low Boost** parameter, as described under “Low Boost” on page 74.

Pitch Slope. (–1.0...2.0, Absolute)

This controls the Oscillator’s **Pitch Slope** parameter, as described under “Pitch Slope” on page 55.

LFO 1 Waveform. (Triangle...Rad6, Absolute)

This selects the waveform for the Oscillator’s **LFO 1**, as described under “Waveform” on page 83.

LFO 2 Waveform. (Triangle...Rad6, Absolute)

This selects the waveform for the Oscillator’s **LFO 2**, as described under “Waveform” on page 83.

Amp LFO 1 Intensity. (–99...+99, Absolute)

This controls the depth and direction of Amp modulation from LFO1, as described under “4–2c: LFO 1/2” on page 78.

Amp LFO 2 Intensity. (–99...+99, Absolute)

This controls the depth and direction of Amp modulation from LFO2, as described under “4–2c: LFO 1/2” on page 78.

Filter LFO 1 Intensity to A. (-99...+99, Absolute)

This controls the depth and direction of Filter A cutoff modulation from LFO1, as described under “3-3a: LFO 1/2” on page 69.

Filter LFO 1 Intensity to B. (-99...+99, Absolute)

This controls the depth and direction of Filter B cutoff modulation from LFO1, as described under “3-3a: LFO 1/2” on page 69.

Filter LFO 2 Intensity to A. (-99...+99, Absolute)

This controls the depth and direction of Filter A cutoff modulation from LFO2, as described under “3-3a: LFO 1/2” on page 69.

Filter LFO 2 Intensity to B. (-99...+99, Absolute)

This controls the depth and direction of Filter B cutoff modulation from LFO2, as described under “3-3a: LFO 1/2” on page 69.

Pitch LFO 1 AMS Intensity. (-12.00...+12.00, Absolute)

You can use an AMS source, such as joystick, to modulate the depth of pitch modulation (vibrato) from LFO1. This controls the intensity of that AMS modulation. For more information, see “4-2c: LFO 1/2” on page 78.

Pitch LFO 2 AMS Intensity. (-12.00...+12.00, Absolute)

This is similar to **Pitch LFO 1 AMS Intensity**, above. For more information, see “4-2c: LFO 1/2” on page 78.

✓ 0-9: Page Menu Commands

- Compare →p.112
- Write Program →p.112
- Exclusive Solo →p.113
- Copy Scene →p.122
- Swap Scene →p.122
- Add To Set List →p.113
- PAGE →p.126
- MODE →p.126

PROGRAM > Basic/X-Y/Controllers

1-1: Program Basic

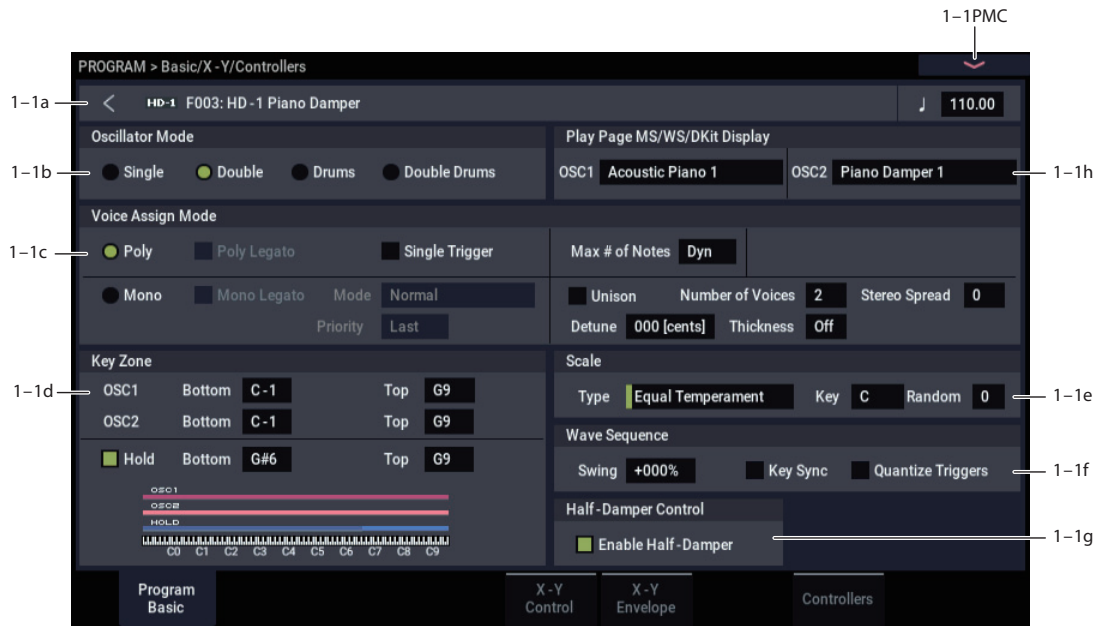

This page contains all of the basic settings for the Program. Among other things, you can:

- Set up the basic Program type: Single, Double, Drum, or Double Drum
- Set the Program to play polyphonically or monophonically
- Create a keyboard split between OSC 1 and OSC 2
- Select the Program's scale
- Make basic Wave Sequence Settings

1-1a: Program Name and Tempo

Bank [A...T]

Program Name [000...127/001...128: Name]

These two read-only parameters show the bank, number, and name of the current Program.

Tempo (♩) [040.00...300.00, EXT]

This is the tempo used for Wave Sequences, LFOs, effects, and ARP. For more information, please see "Tempo" on page 3.

< button

This button is on every page, except for the Top pages of PROGRAM and COMBINATION mode. Press this button to show the Home page, where either Program Select or Combination Select will be selected.

1-1b: Oscillator Mode

Oscillator Mode [Single, Double, Drums, Double Drums]

HD-1 Single Programs have one oscillator, and Double Programs have two oscillators. Each oscillator includes a complete synthesis voice, with velocity-switched multisamples, dual filters, EGs, LFOs, and so on.

The Drum and Double Drum modes are a special variations of Single and Double modes, respectively, using Drum Kits (as created in GLOBAL mode) instead of Multisamples.

Single: The Program will use **one oscillator**, for a **maximum of 140-note polyphony**.

Double: The Program will use **two oscillators**, for a **maximum of 70-note polyphony**.

Drums: The Program will use **one oscillator** to play a Drum Kit. In this case the Program will normally have a **maximum of 140-note polyphony**.

Double Drums: The Program will use **two oscillators** to play two Drum Kits. In this case the Program will normally have a **maximum of 70-note polyphony**.

Note: when playing drum kits, it's often useful to turn on the **Hold** parameter. For more information, see "Hold," on page 38.

A note about polyphony

Polyphony means the number of notes that you can play at a time. This number will vary depending on the particular sound being played, and how that sound is produced. Generally speaking:

- Double Programs use twice as many voices as Single Programs.

- A Wave Sequence uses twice as many voices as a Multisample. A stereo Wave Sequence uses twice as many voices as a mono Wave Sequence.
- Stereo Multisamples use twice as many voices as Mono Multisamples.
- If the X-Y Envelope is enabled, the number of voices used increases slightly.

Polyphony also depends on the effects being used, and on which synthesis types are being used (HD-1, AL-1, CX-3 etc.). For more information, see “0–2: Performance Meter” on page 13.

1–1c: Voice Assign Mode

Voice Assign Mode [Poly, Mono]

Select the basic voice allocation mode. Depending on which one you select, various other options will appear, such as **Poly Legato** (Poly mode only) and **Unison** (Mono mode only).

Poly: The program will play polyphonically, allowing you play chords.

Mono: The program will play monophonically, producing only one note at a time.

Poly

Poly Legato [Off, On]

Poly Legato is available when the **Voice Assign Mode** is set to **Poly**.

Legato means to play note so that they are smooth and connected; the next note is played before the last note is released. This is the opposite of playing detached.

On (checked): When you play a legato phrase, only the first note of that phrase (and notes within 30 msec of the first note) will use the normal multisample start point specified by **Start Offset** (2–1c); all subsequent notes will use the legato start point specified for each multisample.

Note: This is a useful way to simulate the percussive attack of a tonewheel-type organ.

Off (unchecked): Notes will always use the setting of the Start Point Offset, regardless of whether you play legato or detached.

 With some Multisamples, Poly Legato may not have any effect.

Single Trigger [Off, On]

Single Trigger is available when the **Voice Assign Mode** is set to **Poly**.

On (checked): When you play the same note repeatedly, the previous note will be silenced before the next note is sounded, so that the two do not overlap.

Off (unchecked): When you play the same note repeatedly, the notes will overlap.

Mono

Mono Legato [Off, On]

This is available when the **Voice Assign Mode** is set to **Mono**.

Legato means to play note so that they are smooth and connected; the next note is played before the last note is released. This is the opposite of playing detached.

When Mono Legato is On, the first note in a legato phrase will sound normally, and then subsequent notes will have a smoother sound, for more gentle transitions between the notes.

The **Mode** parameter, below, switches between two different Mono Legato effects, each of which achieves this smoothness in a different way. See the description of that parameter for more details.

On (checked): When you play with legato phrasing, the notes within a legato phrase will sound smoother, according to the setting of the **Mode** parameter, below.

Off (unchecked): Legato phrasing will produce the same sound as detached playing.

Mode [Normal, Use Legato Offset]

This parameter is available only when **Mono Legato** is On.

Normal: When you play legato, the multisample, envelopes, and LFOs will not be reset; only the pitch of the oscillator will change. This setting is particularly effective for wind instruments and analog synth sounds.

 With this option, the pitch may occasionally be incorrect, depending on which multisample you play, and where on the keyboard you play.

Use Legato Offset: When you play legato, the second and subsequent notes will use the legato start point specified for each multisample, rather than the **Start Offset** (2–1c) setting.

This is effective when used with a multisample for which you’ve assigned a specific legato offset point. For example, you might use it to control the attack of a breathy, slow-attack sax sound. On some multisamples, this will have no effect.

Envelopes and LFOs will still be reset, as they are with detached playing.

Priority [Low, High, Last]

Priority is available when the **Voice Assign Mode** is set to **Mono**.

This parameter determines what happens when more than one note is being held down.

Low: The lowest note will sound. Many vintage, monophonic analog synths work this way

High: The highest note will sound.

Last: The most recently played note will sound.

Max # of Notes

Max # of Notes [Dynamic, 1...16]

Dynamic is the default. With this setting, you can play as many notes as the system allows.

1-16 lets you limit the maximum number of notes played by the Program. Voices will still be allocated dynamically, up to this maximum number. You can use this to:

- Model the voice-leading of vintage synthesizers, such as the Polysix
- Control the resources required by individual Programs in COMBINATION and SEQUENCER modes

Max # of Notes applies only when the main **Voice Assign Mode** is set to **Poly**. If **Mono** is selected, this is grayed out.

This setting does not limit the **Unison Number of Voices** parameter. For instance, if **Max # of Notes** is set to **6**, and **Unison Number of Voices** is set to **3**, you can play up to 6 notes, each with 3 Unison voices.

If the Program is set to **Double**, the **Max # of Notes** applies equally to both Oscillators. For instance, if **Max # of Notes** is set to **4**, you can play up to 4 notes on each OSC.

Unison

Unison [On, Off]

Unison can be used in both **Mono** and **Poly** modes.

On (checked): When Unison is on, the Program uses two or more stacked, detuned voices to create a thick sound.

Use the **Number of Voices** and **Detune** parameters to set the number of voices and amount of detuning, and the **Thickness** parameter to control the character of the detuning.

Off (unchecked): The Program plays normally. If **Unison** is **Off**, then all of its associated parameters are grayed out.

Number of voices [2...16]

This controls the number of detuned voices that will be played for each note when using **Unison**. It applies only when **Unison** is **On**.

Stereo Spread [0...100]

Stereo Spread lets you create a wider stereo field when using **Unison**. It applies only when **Unison** is **On**.

This feature separates the different Unison voices into two groups. One group is panned to the left, and the other to the right. At **0**, both groups will be in the center; at **100**, the two groups will be hard-panned left and right, respectively; at intermediate values, they will be panned to intermediate left and right positions.

If there is an odd number of voices, one voice will be panned to the center.

If the voices are true stereo, **Stereo Spread** “steers” the stereo image of each voice. In this case, intermediate settings of **Stereo Spread** may be the most effective, since they will still preserve some of the original stereo image.

Unison detuning is spread as evenly as possible across the left and right channels. The lowest voice will be on the left, and the highest on the right; the next-lowest on the left, and the next-highest on the right, etc., as below:

-14 cents: L

+14 cents: R

-10 cents: L

+10 cents: R etc.

Depending on the **Thickness** setting, the detuning may lean slightly to one side.

Detune [0...200 cents]

Detune is available when **Unison** is **On**.

This parameter sets the tuning spread for the Unison voices, in cents (1/100 of a semitone). The **Thickness** parameter, below, controls how the voices are distributed across the detune amount. When **Thickness** is **Off**, the voices are distributed evenly, centered around the basic pitch.

For instance, let’s say that the **Number of voices** parameter is set to **3**, **Detune** is set to **24**, and **Thickness** is **Off**:

Voice one will be detuned down by 12 cents, voice two will not be detuned, and voice three will be detuned up by 12 cents.

| Voice | Detune |
|-------|--------|
| 1 | -12 |
| 2 | 0 |
| 3 | +12 |

As another example, let’s say that **Detune** is still set to **24** and **Thickness** is still **Off**, but **Number of voices** is set to **4**:

Voice one will still be detuned down by 12 cents, voice two will be detuned down by 4 cents, voice three will be detuned up by 4 cents, and voice 4 will be detuned up by 12 cents.

| Voice | Detune |
|-------|--------|
| 1 | -12 |
| 2 | -4 |
| 3 | +4 |
| 4 | +12 |

Thickness [Off,01...09]

Thickness is available when **Unison** is **On**.

This parameter controls the character of the detuning for the unison voices.

Off: Unison voices will be evenly distributed across the Detune range, as shown above.

01–09: Unison voices will be detuned in an asymmetric way, increasing the complexity of the detune, and changing the way in which the different pitches beat against one another. This creates an effect similar to vintage analog synthesizers, in which oscillators were frequently slightly out of tune. Higher numbers increase the effect.

1–1d: Key Zone

You can create keyboard splits by setting top and bottom keys for Oscillators 1 and 2. Also, you can control the keyboard range over which the **Hold** parameter takes effect.

Setting Key Zones from the keyboard

In addition to using the standard data entry controls, you can also set all keyboard zones parameters directly from the keyboard. Just do the following:

1. Select the key zone parameter you’d like to edit.
2. Press and hold the ENTER button.
3. Play a note on the keyboard to set the parameter.
4. Release the ENTER button.

You can use this shortcut for all key and velocity parameters in the NAUTILUS.

Osc 1 Bottom [C–1...G9]

This sets the lowest key on which Oscillator 1 will play.

Osc 1 Top [C-1...G9]

This sets the highest key on which Oscillator 1 will play.

Osc 2 Bottom [C-1...G9]

This sets the lowest key on which Oscillator 2 will play.

Osc 2 Top [C-1...G9]

This sets the highest key on which Oscillator 2 will play.

Hold [On, Off]

Hold is like permanently pressing down on the sustain pedal. In other words, notes continue to sound as if you were holding down the key - even after you lift your fingers from the keyboard.

Unless the **Sustain Level** is set to **0** in Amp EG 1 (and Amp EG 2 in a Double Program), the sound will play for the entire length of the sample(s).

On (checked): The **Hold** function is enabled for the range set by the **Hold Bottom** and **Hold Top** parameters, below.

Off (unchecked): Notes will play normally. This is the default setting.

Using Hold with Drum Kits

Hold can be especially useful for drum programs, since it lets the samples ring out naturally. In general, when you set the **Oscillator Mode** to **Drums**, it's good to set **Hold** to **On**.

Once you've turned on **Hold** for a drum program, the function is controlled on a note-by-note basis according to settings within the selected Drum Kit.

If a key's **Enable Note Off Receive** parameter (on the **Voice Mixer** tab of the **Drum Kit** page) is unchecked, the note will be held.

If the key's **Enable Note Off Receive** parameter is checked, it will not be held.

If you turn off **Hold** in the Program, no keys will be held - regardless of their **Enable Note Off Receive** setting.

Using Hold with Acoustic Pianos

Hold is also useful for simulating the top octaves of an acoustic piano, in which notes always sustain until they fade out naturally, regardless of how long you hold the key.

The **Hold Bottom** and **Hold Top** parameters are designed for exactly this purpose. They let you limit the effect of the Hold parameter to a specific range of the keyboard.

Hold Bottom [C-1...G9]

This sets the lowest key affected by the Hold function.

Hold Top [C-1...G9]

This sets the highest key affected by the Hold function.

1-1e: Scale**Type [Equal Temperament...User Octave Scale15]**

Selects the basic scale for the Program.

Note that for many of the scales, the setting of the **Key** parameter, below, is very important.

Equal Temperament: This is the most widely used scale by far, in which each semitone step is spaced at equal pitch intervals.

Equal Temperament allows easy modulation, so that a chord progression played in the key of C sounds roughly the same as the same progression played in F#. Sacrificed, however, is some of the purity of individual intervals offered by the scales below.

Pure Major: In this temperament, major chords of the selected key will be perfectly in tune.

Pure Minor: In this temperament, minor chords of the selected key will be perfectly in tune.

Arabic: This scale includes the quarter-tone intervals used in Arabic music.

Pythagoras: This scale is based on ancient Greek musical theory, and is especially effective for playing melodies. It produces completely pure fifths, with one exception, at the expense of detuning other intervals— thirds in particular.

As much as Pythagoras might have like to do so, it's not possible to make all the fifths pure while also keeping the octave in tune. For the sake of the octave, one of the fifths—the interval from the sharp fourth degree to the sharp first degree—is made quite flat.

Werkmeister (Werkmeister III): This scale was one of the many temperament systems developed towards the end of the Baroque period. These "Well-Tempered" tunings were aimed at allowing relatively free transposition—although you'll still notice that the different keys maintain their own distinct characteristics, unlike Equal Temperament.

J.S. Bach was referring to these new scales in his title, "The Well-Tempered Clavier." As such, this group are particularly appropriate for late baroque organ and harpsichord music.

Kirnberger (Kirnberger III): This is a second "Well-Tempered" tuning, dating from the early 18th century.

Slendro: This is an Indonesian gamelan scale, with five notes per octave.

When **Key** is set to **C**, use the C, D, F, G and A notes. Other keys will play the normal equal-tempered pitches.

Pelog: This is another Indonesian gamelan scale, with seven notes per octave.

When **Key** is set to **C**, use the white keys. The black keys will play the equal tempered pitches.

Stretch: This tuning is used for acoustic pianos.

User All Notes Scale: This is a user-programmed scale with different settings for all 128 MIDI notes. You can set up this scale in GLOBAL > Controllers/Scales— User Scale page.

User Octave Scale 00-15: These are user-programmed scales with settings for each of the 12 notes in an octave. You can set them up in GLOBAL > Controllers/Scales— User Scale page.

Key (Scale Key) [C...B]

Selects the key of the specified scale.

This setting does not apply to the **Equal Temperament**, **Stretch**, and **User All Notes** scales.

 If you're using a scale other than Equal Temperament, the combination of the selected scale and the **Key** setting may skew the tuning of the note. For example, A above middle C might become 442 Hz, instead of the normal 440 Hz. You can use the GLOBAL Mode's **Master Tune** parameter to correct this, if necessary.

Random**[0...7]**

This parameter creates random variations in pitch for each note. At the default value of **0**, pitch will be completely stable; higher values create more randomization.

This parameter is handy for simulating instruments that have natural pitch instabilities, such as analog synths, tape-mechanism organs or acoustic instruments.

1-1f: Wave Sequence

The **Swing**, **Key Sync**, and **Quantize Trigger** settings in this section affect how the Program plays its Wave Sequences. These settings are stored within the Program, and do not change the original Wave Sequence data.

Swing**[-300%...+300%]**

This parameter applies only when the Program is using one or more Wave Sequences set to Tempo mode.

Use **Swing** to add a sense of swing to the rhythm. For example, Swing provides an easy way to turn a “square” rhythm into a shuffle groove.

Swing works by adjusting the position of the up-beats, relative to the Wave Sequence’s Resolution setting. For instance, if the Resolution is set to 1/8, Swing affects every other 8th note.

When Swing is set to **+100%**, these notes will be moved one third of the way toward the next down-beat. If the Resolution is 1/8, for example, **+100%** changes straight 8th notes into 8th note triplets.

When Swing is set to **+300%**, up-beats will be moved all the way to the next down-beat. At this point, the notes on the up-beats will not be heard at all.

Positive values make the up-beats later, and negative values make them earlier.

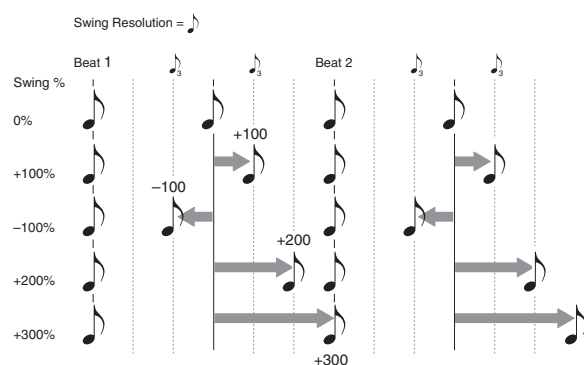
Wave Sequence Swing**Swing uses the Wave Sequence’s Resolution setting**

Since the programmed rhythms of Tempo Wave Sequences can vary widely, each has its own Swing Resolution setting, from 1/32 note triplets to 1/4 note.

If the Program contains two or more Wave Sequences with different Swing Resolution settings, the Program will use the finest value. For example, if one is set to 1/8 and the other is set to 1/16, the Program will use 1/16 notes.

Key Sync**[On, Off]**

On (checked): When Key Sync is On, each note’s Wave Sequence(s) will progress independently, so that each one can be on a different step, or moving at a different rate.

Off (unchecked): When Key Sync is Off, all of the Wave Sequences will be synchronized on the same step. There is one exception to this, however: if Duration is modulated with velocity or note-number, the Wave Sequences can still progress at different rates.

Quantize Trigger**[On, Off]**

This parameter applies only when the Program is using one or more Wave Sequences set to Tempo mode.

It allows you to force most Tempo-mode Wave Sequence note-ons to be in sync, making it easier to play along with other rhythmic elements.

When Quantize Triggers is On, note-ons are quantized to 8th notes using the current tempo reference. (See below for a few more details.)

The tempo reference can come from different sources, depending on the current mode, and whether or not ARP is on:

- In PROGRAM and COMBINATION modes, if ARP is off, note-ons are synchronized with the sounding Tempo-mode Wave Sequence, if any.
- In PROGRAM and COMBINATION modes, if ARP is on, note-ons are synchronized with ARP.
- In SEQUENCER mode during playback or recording, note-ons are synchronized with the sequence.
- In SEQUENCER mode, while the sequencer is stopped, note-ons are synchronized with RPPR and ARP.

On (checked): Note-ons will be quantized.

Off (unchecked): Note-ons will be played instantly, the moment that you play the keyboard.

How Quantize Trigger works

The Quantize Trigger feature tries to make a good guess at where you intended the note to be. If you play the note just a bit late—within a 32nd note of the 8th note—it will assume that you meant the note to sound on the beat that just passed. In this case, the note will play immediately.

On the other hand, if you play the note up to three 32nd notes early, it will assume that you’re intending the note to sound on the next beat. In this case, the note-on is delayed until the next 8th note.

1-1g: Half-Damper Control

A half-damper pedal is a special type of continuous foot pedal, such as the Korg DS-1H. In comparison to a standard footswitch, half-damper pedals offer more subtle control of sustain, which can be especially useful for piano sounds.

The NAUTILUS will automatically sense when a half-damper is connected to the rear-panel DAMPER input. For proper operation, you will also need to calibrate the pedal, using the Calibrate Half-Damper command in the Global page menu.

The off and full-on positions of the half-damper work just like a standard footswitch. In conjunction with the **Enable Half-Damper** parameter, below, intermediate positions allow a graduated control of sustain, similar to the damper pedal of an acoustic piano.

Enable Half-Damper [On, Off]

When this is **On** (checked), Half-Damper pedals, normal sustain pedals, and MIDI CC# 64 will all modulate the Amp EG, as described below.

When this is **Off** (un-checked), the pedals and MIDI CC#64 will still hold notes as usual, but will not modulate the Amp EG.

Half-Damper Pedal and Release Time

The amount of modulation depends on whether the Amp EG **Sustain Level** is set to **0** (as is the case with most acoustic piano sounds), or set to **1** or more. The modulation is continuous, from 1x (no change) to 55 times longer; the table below shows a selection of representative points.

Half-Damper modulation of Amp EG Release Time

| CC#64 Value | Multiply Amp EG Release Time by... | |
|-------------|------------------------------------|------------------------|
| | If Sustain = 0 | If Sustain = 1 or more |
| 0 | 1x | 1x |
| 32 | 2.1x | 2.1x |
| 64 | 3.2x | 3.2x |
| 80 | 5.9x | |
| 96 | 22.3x | |
| 127 | 55x | |

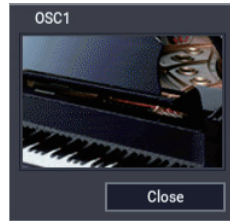

✓ **1-1: Page Menu Commands**

- Compare →p.112
- Write Program →p.112
- Exclusive Solo →p.113
- Copy Oscillator →p.119
- Swap Oscillator →p.119
- PAGE →p.126
- MODE →p.126

1-1h: Play Page MS/WS/DKit Display

OSC1

[List of installed Play Page MS/WS/DKit Display]

This works in conjunction with the Home page's **Show MS/WS/DKit Graphics** menu command (and its corresponding Global parameter) to control whether the PROGRAM > Home page shows the overview/jump parameters (the graphical envelopes, LFOs, etc.), or the selected graphics.

If the **Show MS/WS/DKit Graphics** menu command is not enabled, then the overview/jump parameters will be shown regardless of the setting here.

If **Show MS/WS/DKit Graphics** is enabled (checked), then this parameter takes effect. See also "Show MS/WS/DKit Graphics" on page 113.

MS/WS/DK Names shows the names of Osc 1's Multisamples, Wave Sequences, or Drum Kit as part of the overview/jump parameters.

If a graphic is selected, then the graphic will be shown instead of the normal overview/jump parameters.

OSC2

[List of installed Play Page MS/WS/DKit Display]

This controls the PROGRAM > Home page display for Osc 2. It works the same as "OSC1," above.

1-5: X-Y Control

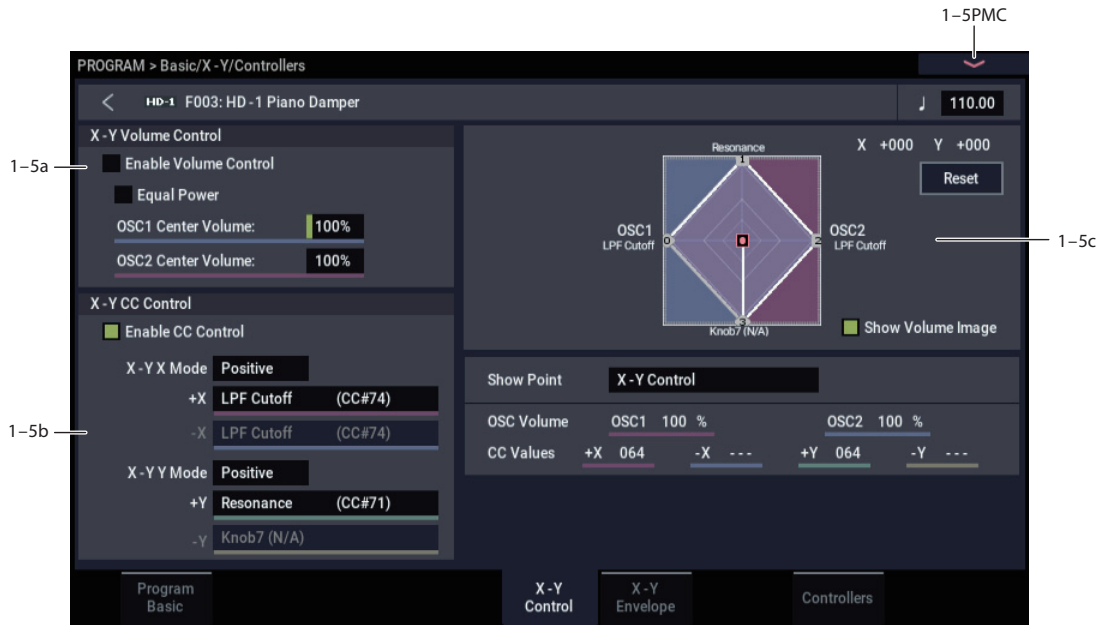

X-Y Control is a function used for vector synthesis control. Vector synthesis is a function that controls the parameters of programs or effects by using an X-Y envelope that you configure.

What does Vector mean?

Modulation generally works by moving a single control, like a knob, in a straight line. At one end of the control, the modulation is at its minimum; at the other end, it's at its maximum.

Vector Synthesis is a little different. It works by moving around a point on a two-dimensional plane, both left-right and up-down.

X-Y Point and X and Y axis values

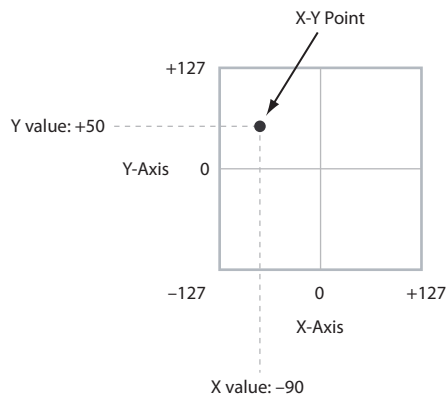

You can think of this point as being positioned on two different lines at once: a left-right line (the X axis), and an up-down line (the Y axis).

In other words, instead of just having one value (like a knob), each X-Y point has two values: one for X, and one for Y. See the graphic “X-Y Point and X and Y axis values” for an example.

You can also use the X-Y control to move its position automatically over time, as shown below.

X-Y control moving the X-Y Point

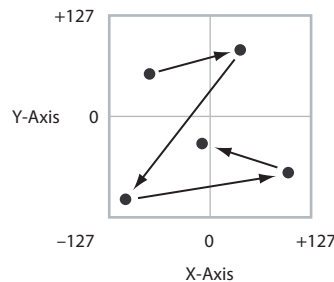

X-Y Volume Control and CC Control

The Vector does two main things: it can control the relative volume of the two Oscillators in PROGRAM mode (or of up to 16 Programs at once in COMBINATION mode), and it can generate CCs for controlling Program and Effects parameters.

Vector and MIDI

The Vector features interact with MIDI through the X-Y CC Control.

The **X-Y CC Control**, is generated by the X-Y position. Normally, this will only affect internal sounds and effects. If you like, however, you can use a Global parameter to send these generated CCs to external MIDI devices; for more information, see “X-Y MIDI Out” on page 653.

1-5a: X-Y Volume Control

X-Y Volume Control lets you adjust the relative volumes of Oscillators 1 and 2 by moving the X-Y Control from left to right on the X axis. The Drum Track is not affected.

The **Equal Power** check-box makes the Vector create a smooth fade between the two Oscillators, while the OSC1/2 Center Volume parameters allow you to create more complex fade shapes.

In COMBINATION mode, you can use this to control the relative volumes of up to 16 Programs at once, using both the X and Y axes. For more details, see the X-Y Control section of COMBINATION mode.

Enable Volume Control [Off, On]

When this box is checked, the X-Y position will control the volumes of Oscillators 1 and 2.

When this box is not checked, the X-Y position will not directly affect volume. However, it's still possible for the Vector to control volume via X-Y CCs and AMS.

Note: "X-Y Volume Control" cannot be used to control the volume of the drum track.

Equal Power [Off, On]

This applies only when **Enable Volume Control** is turned **On**.

When **Equal Power** is **On**, the Vector will fade between Oscillators 1 and 2 using an equal-power volume curve. This provides a smooth fade between the two sounds, and is the type of volume control used by classic vector synths.

Also, when this is checked, the OSC 1 and OSC 2 **Center Volume** parameters will be grayed out, since Equal Power sets the center volumes automatically.

When **Equal Power** is **Off**, the OSC 1 and OSC 2 **Center Volume** parameters determine the way in which X-Y position affects volume.

OSC1 Center Volume [0, 25, 50, 75, 100%]

This sets the volume of Oscillator 1 at the center of the X axis. It applies only when **Equal Power**, above, is set to **Off**.

The volumes at the extreme ends of the X axis are fixed. At the left side, Osc 1 is always at 100% volume; at the right side, Osc 1 is always at 0%.

OSC2 Center Volume [0, 25, 50, 75, 100%]

This sets the volume of Oscillator 2 at the center of the X axis.

The volumes at the extreme ends of the X axis are fixed, in the opposite direction of Oscillator 1's. At the left side, Osc 2 is always at 0% volume; at the right side, Osc 2 is always at 100%.

Osc Center Volume and X-Axis Position

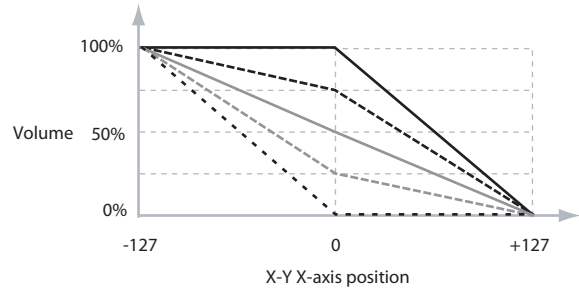

Center Volume Values:

| | |
|-----------|-----|
| ————— | 100 |
| - - - - - | 75 |
| ————— | 50 |
| - - - - - | 25 |
| | 0 |

1-5b: X-Y CC Control

X-Y CC Control lets you use the combination of the X-Y Control and the X-Y Envelope as AMS sources, for modulating Program parameters, and as DMod sources, for modulating Effects.

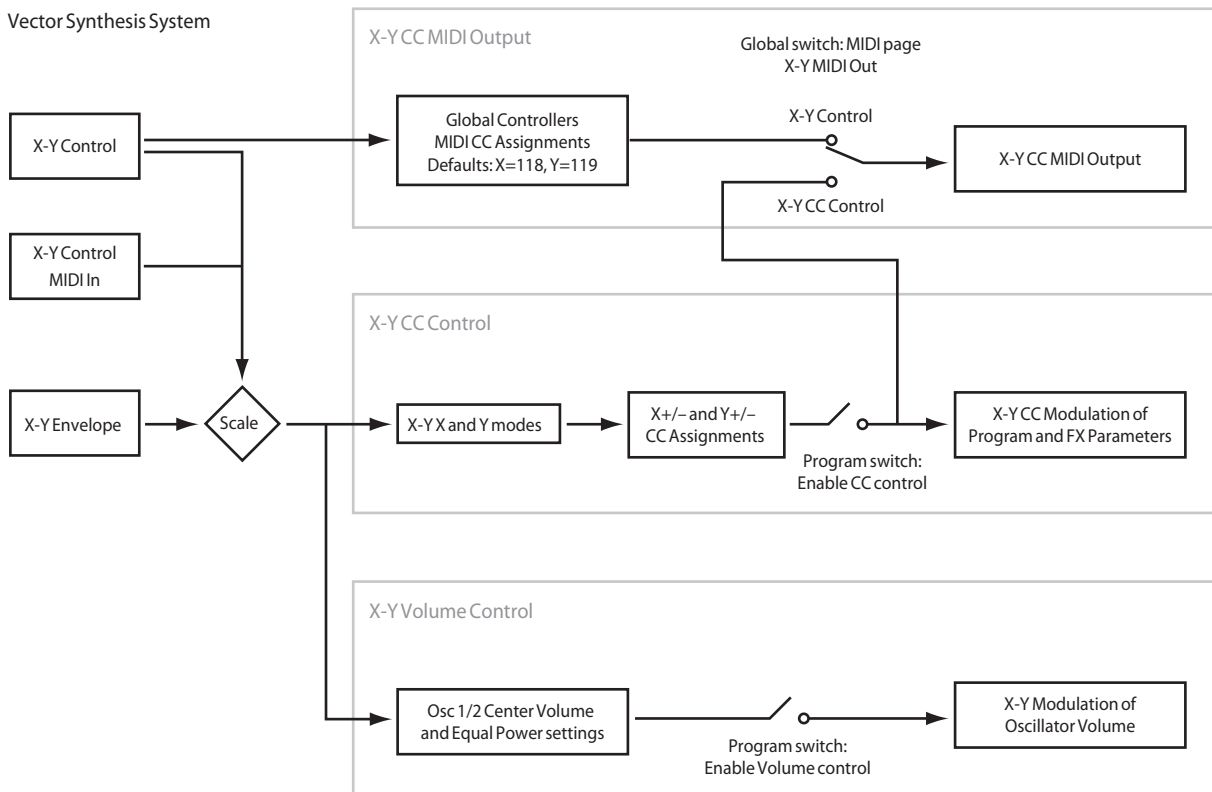

Each of the four directions of the Vector can send a different CC, including left (-X), right (+X), up (+Y), and down (-Y). You can choose between several different patterns combining these four directions by using the X-Y X Mode and X-Y Y Mode parameters.

You can either use the X-Y CCs to automate existing modulation routings, such as the X-Y-panel knobs, or as distinct modulation sources. The X-Y CC is transmitted as MIDI control change messages on the global MIDI channel. This means that it controls all voices of the program, not individual voices.

Note: A Global parameter allows you to enable or disable MIDI output for the CC Control. By default, this is disabled. This setting does not affect the internal Programs, which can always receive the X-Y CCs.

Enable CC Control [Off, On]

When this box is checked, the X-Y position will control the CCs assigned to +X, -X, +Y, and -Y, as set below.

When this box is not checked, the X-Y position will not affect these CCs. However, the joystick will still send and receive its dedicated MIDI CCs, just like other physical controllers. See “Vector and MIDI,” above, for more information.

X-Y X Mode [Positive, Negative, Xfade, Split]

You can set up the Vector to send out CCs in several different patterns, as shown in the graphic below. This controls the pattern for the X axis. Note that this setting affects only CC Control; it has no effect on Volume Control.

X-Y CC Modes

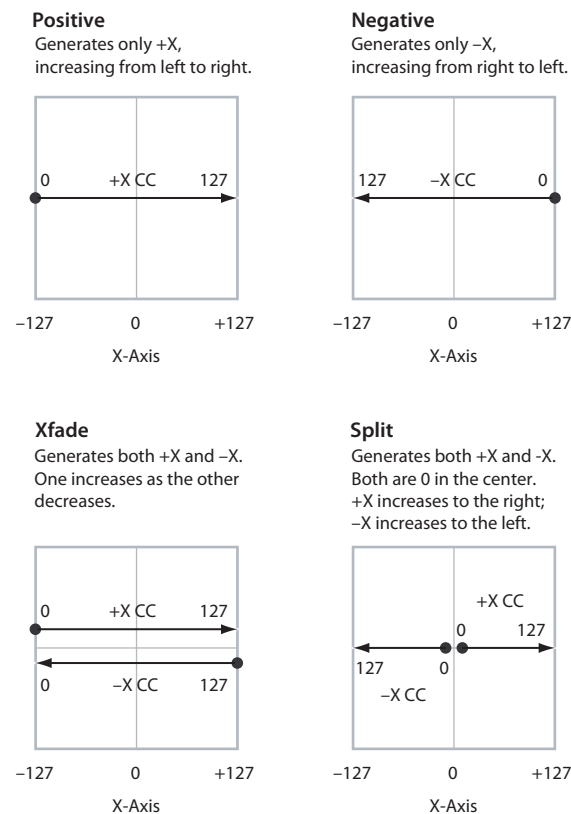

Positive sends out only +X, starting at 0 at the far left, and increasing to 127 at the far right. -X is disabled in this mode.

Negative sends out only -X, starting at 0 at the far left, and increasing to 127 at the far right. In this mode, +X is grayed out.

Xfade sends out both +X and -X, overlapping throughout the X axis. As one increases, the other decreases.

Split sends out both +X and -X, with a split in the center. +X is sent when the point moves to the right of the center, and -X is sent when the point moves to the left of center.

+X [Off...MIDI CC#119]

This assigns the controller sent by the +X X-Y. You can use this as an AMS source to control Program parameters, or as a DMod source to control Effects parameters. It will be grayed out if the X-Y X Mode, above, is set to Negative.

In addition to the standard list of MIDI controllers, you can also assign the +X X-Y to duplicate the function of several front-panel controllers, including JS X, JS+X, JS-X, and SW 1-2.

For instance, if you assign +X to Knob 6, the X-Y's +X will use the controller assigned to Knob 6 on the Basic/X-Y/Controllers- Controllers page.

Finally, you can also assign +X to control the Master Volume.

-X [Off...MIDI CC#119]

This assigns the controller sent by the -X X-Y. It will be grayed out if the X-Y X Mode, above, is set to Positive.

The selections are the same as for +X, above.

X-Y Y Mode [Positive, Negative, Xfade, Split]

This controls the X-Y CC pattern for the Y axis. For more information, see the description under X-Y X Mode, above.

+Y [Off...MIDI CC#119]

This assigns the controller sent by the +Y X-Y. It will be grayed out if the X-Y Y Mode, above, is set to Negative.

The selections are the same as for +X, above.

-Y [Off...MIDI CC#119]

This assigns the controller sent by the -Y X-Y. It will be grayed out if the X-Y Y Mode, above, is set to Positive.

The selections are the same as for +X, above.

1-5c: X-Y Graphic

X-Y Graphic

This is a diagram of the X-Y Control, including the five points of the X-Y Envelope (labeled 0-4) and the current position of the X-Y Control (labeled J).

The transitions between the EG's points are shown by white lines.

Touch this area to control the vector by moving the X-Y point.

Show Volume Image [Off, On]

The X-Y Control includes an image representing the current X-Y Volume Control settings. You can use the Show Volume Image check-box to toggle this part of the graphic on and off.

Show Point

**[X-Y Control,
X-Y Envelope Point 0...4]**

You can view the volume and CC values for the current position of the X-Y Control, or for any of the EG's five points.

Oscillator Volume & CC Display

This read-only display shows the volume and CC values for the current X-Y point, as selected by the Show Point parameter, above.

✓ 1-5: Page Menu Commands

- Compare →p.112
- Write Program →p.112
- Exclusive Solo →p.113
- Copy Oscillator →p.119
- Swap Oscillator →p.119

- PAGE →p.126
- MODE →p.126

1-6: X-Y Envelope

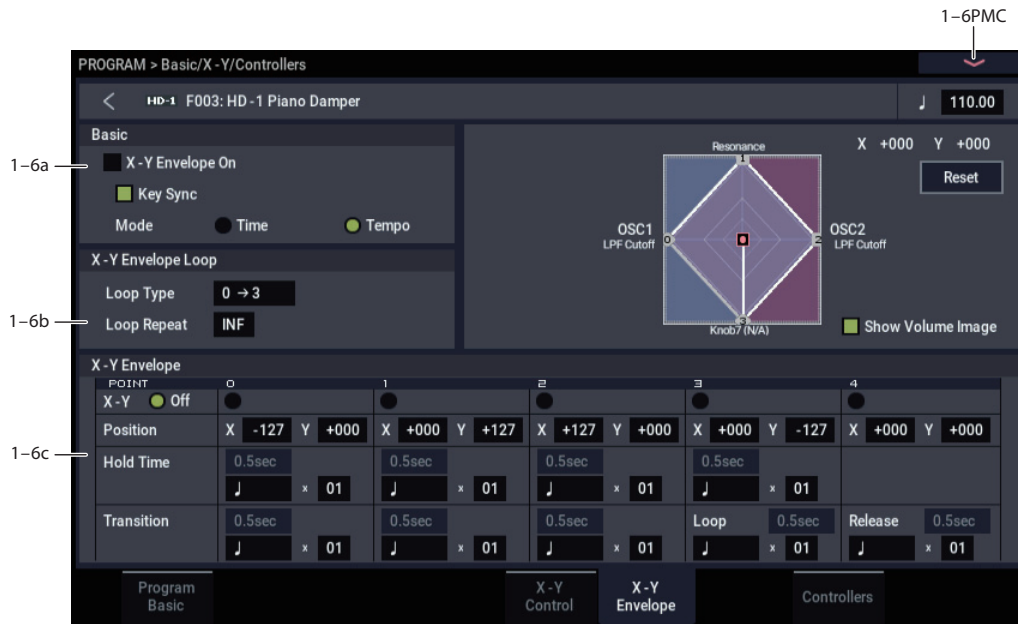

The X-Y Envelope works to control the X-Y position. It's also special because it's the only programmable modulation source which lets you modulate both Program and Effects parameters.

The X-Y Envelope is different from the other envelopes in several ways:

- Each point has two “levels” - one for the X axis, and one for the Y axis.
- The envelope times can be based on seconds and milliseconds, or synced to tempo.
- Each point has a hold time, as well as a transition time to the next point.
- The envelope can loop between two points, for either a specified number of repeats, or as long as you hold the note.

X-Y Volume and CC control use separate EGs

There are actually two different X-Y Envelopes, which share the same parameters: one for Volume Control, and the other for CC Control.

All of the notes in the Program share a single CC Control EG, since there can only be one set of CCs for each MIDI channel. This EG starts when you first play a note, and continues as long as any notes are held down on the keyboard. When you release all of the notes, the EG goes into its release phase.

Each note then has its own, additional Volume Control EG. The **Key Sync** parameter applies only to this per-note EG.

When the **Key Sync** parameter is **Off**, the CC Control and Volume Control EGs are completely synchronized.

When **Key Sync** is **On**, each note's Volume Control EG will start at note-on, and go into release at note-off. All the notes will still share a single CC Control EG.

1-6a: Basic

X-Y Envelope On

[Off, On]

On (checked): When this box is checked, the X-Y Envelope will work to control the X-Y position.

Off (unchecked): When this box is not checked, the X-Y Envelope will not run.

Key Sync

[Off, On]

The Key Sync parameter applies only to X-Y Volume control. As described under “X-Y Volume and CC control use separate EGs,” above, X-Y CC control always acts as if Key Sync were Off.

On (checked): When Key Sync is **On**, the X-Y Volume EG starts each time you press a key, and an independent EG runs for each note. This is the normal setting.

Off (unchecked): When Key Sync is **Off**, the X-Y Volume EG starts from the phase determined by the first note in the phrase, so that the EGs for all notes being held are synchronized together.

Mode

[Time, Tempo]

Time: When the Mode is set to **Time**, you can set the EG segment times in seconds or milliseconds.

Tempo: When the Mode is set to **Tempo**, the X-Y Envelope will synchronize to the system tempo, as set by either the Tempo knob or MIDI Clock. Instead of using seconds and milliseconds, you can specify the EG times as rhythmic values, using the Base Note and Multiplier parameters.

1-6b: X-Y Envelope Loop

The X-Y Envelope can loop between two points, and can continue to loop either for as long as you hold the note, or for a specified number of repeats. You can also turn the loop off completely, if you like.

Loop Type [0→3, 1→3, 2→3, 0←→3, 1←→3]

This selects the start and end points of the loop, and whether the loop is forwards only or forwards-backwards.

The first three selections, 0→3, 1→3, and 2→3, loop forwards only. For instance, when Loop Type is set to 1→3, the EG will play as follows: 0, 1, 2, 3, 1, 2, 3, 1, 2, 3 etc.

The last two selections, 0←→3 and 1←→3, are forwards-backwards. For instance, with the 1←→3 setting, the EG will play as follows: 0, 1, 2, 3, 2, 1, 2, 3 etc.

Loop Repeat [Off, 1...126, INF]

Off: When this is set to Off, the EG will not loop at all.

1-126: The EG will loop the specified number of times, and then hold at point 3 until the note is released.

INF: The EG will loop as long as the note is held, and then move to point 4 when the note is released.

1-6c: X-Y Envelope

Like the Filter, Amp, and Pitch EGs, the X-Y Envelope has a total of five points. Since the X-Y Envelope can loop, however, the points are labeled differently; instead of names like attack and decay, they are simply numbered 0-4.

Sustain and Release

When the EG is in the middle of a loop, there is no “sustain” point per se. However, if the EG has already completed the specified number of **Loop Repeats**, or if **Loop Repeat** is Off, it will sustain at Point 3 until release.

At release, the EG always moves to Point 4.

Hold and Transition times

The Hold Time sets how long the EG lingers at each point, and the Transition time sets how long it takes to go from the selected point to the next.

For instance, the graphic below shows the succession of Hold and Transition times when the Loop Type is set to 1→3. For clarity, only the Y axis positions are shown.

X-Y Envelope times, Loop Type = 1→3

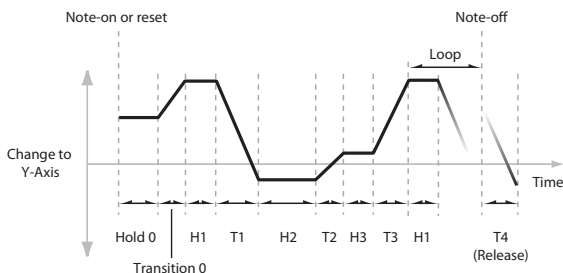

The transition from Point 3 into the loop always uses Point 3's Transition time, regardless of the Loop Type.

Points 0, 1, and 2's Transition times, however, work in reverse when moving backwards during a forwards-backwards loop. It's as if you were re-tracing the EG shape in reverse.

For instance, in the backwards section of a loop, moving from Point 2 to Point 1 uses Point 1's Transition time.

Forwards-Backwards Loop, Loop Type = 1←→3

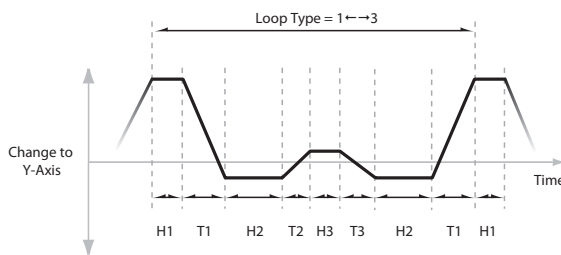

X-Y [Off, 0...4]

This horizontal row of radio buttons lets you edit the selected point's X-Y position using the X-Y Control.

Just press the point's radio button, move the X-Y Control to the desired location. When you're finished, press the Off radio button again.

When you are not editing the EG's X-Y positions, you should leave this set to Off, to avoid inadvertent changes to the EG.

Point 0

Position

In addition to editing the X and Y parameters with the standard data entry controls, you can also simply use the X-Y Control to set the position, as described under “X-Y,” above.

X [-127...+127]

This sets the point's position on the X axis.

Y [-127...+127]

This sets the point's position on the Y axis.

Hold Time

This sets the length of time that the EG will stay on Point 0, before moving to Point 1. You can set the Hold Time in either seconds/milliseconds or rhythmic values, depending on the setting of the EG's Mode parameter.

Time [0ms...60sec]

This parameter lets you set the Hold Time in seconds and milliseconds. It applies only when the Mode is set to Time.

(Base Note) [Off, ♩...♩]

This menu sets a basic rhythmic value for the **Hold Time**, relative to the system tempo. The values range from a 32nd note to a whole note, including triplets.

This parameter applies only when the **Mode** is set to **Tempo**.

x (Multiply Base Note by...) [01...32]

This multiplies the length of the **Base Note**. For instance, if the Base Note is set to a sixteenth note, and the multiplier is set to 3, the Hold Time will last for a dotted eighth note.

Transition

This sets the length of time that the EG takes to move from Point 0 to Point 1.

When the **Loop Type** is set to 0←→3, this also sets the time that it takes to move from Point 1 to Point 0 during the backwards section of the loop.

Time [0ms...60sec]

This parameter lets you set the Transition time in seconds and milliseconds. It applies only when the Mode is set to Time.

(Base Note) [Off... 6]

This sets a basic rhythmic value for the **Hold Time**, relative to the system tempo. The values range from a 32nd note to a whole note, including triplets.

This parameter applies only when the **Mode** is set to **Tempo**.

x (Multiply Base Note by...) [01...32]

This multiplies the length of the **Base Note**. For instance, if the **Base Note** is set to a sixteenth note, and the multiplier is set to 3, the EG will move from Point 0 to Point 1 over a dotted eighth note.

Points 1 and 2

Points 1 and 2 work exactly like Point 0, as described above.

Point 3

Point 3 also works much like Points 0-2, with two main differences:

Point 3 always uses its own **Time** when moving into the loop, regardless of the direction of the loop.

If **Loop Repeat** is set to Off, or if the number is set between 1-126 and has already played the specified number of times, then the EG will stay at Point 3 until the EG either goes into release.

Hold Time

This works just like the **Hold Time** for Point 0, as described under "Hold Time" on page 46.

Loop

This sets the length of time that it takes to move from Point 3 to the first Point in the loop. You can set this in either seconds/milliseconds or rhythmic values, depending on whether the Mode is set to Time or Tempo.

The Time, Base Note, and Multiplier parameters work just like those for Point 0, as described under "Transition" on page 46.

Point 4

Point 4 is the X-Y Envelope's release destination. Its time setting is different from those of the other Points. Instead of setting the time it takes to move from Point 4 to the next Point, it sets how long it takes to go from the previous Point to Point 4.

The EG moves to Point 4 as soon as it releases, regardless of where it was before the release. For instance, let's say that the EG is in the middle of Point 2's Hold Time at note-off. The EG will immediately begin to move to Point 4, without waiting for the Hold Time to complete.

Release

This sets the length of time that it takes to move to Point 4 after note-off. You can set this in either seconds/milliseconds or rhythmic values, depending on whether the **Mode** is set to Time or Tempo.

The **Time**, **Base Note**, and **Multiplier** parameters work just like those for Point 0, as described under "Transition" on page 46.

✓ 1-6: Page Menu Commands

- Compare →p.112
- Write Program →p.112
- Exclusive Solo →p.113
- Copy Oscillator →p.119
- Swap Oscillator →p.119
- Copy X-Y Envelope →p.119
- PAGE →p.126
- MODE →p.126

1-8: Controllers

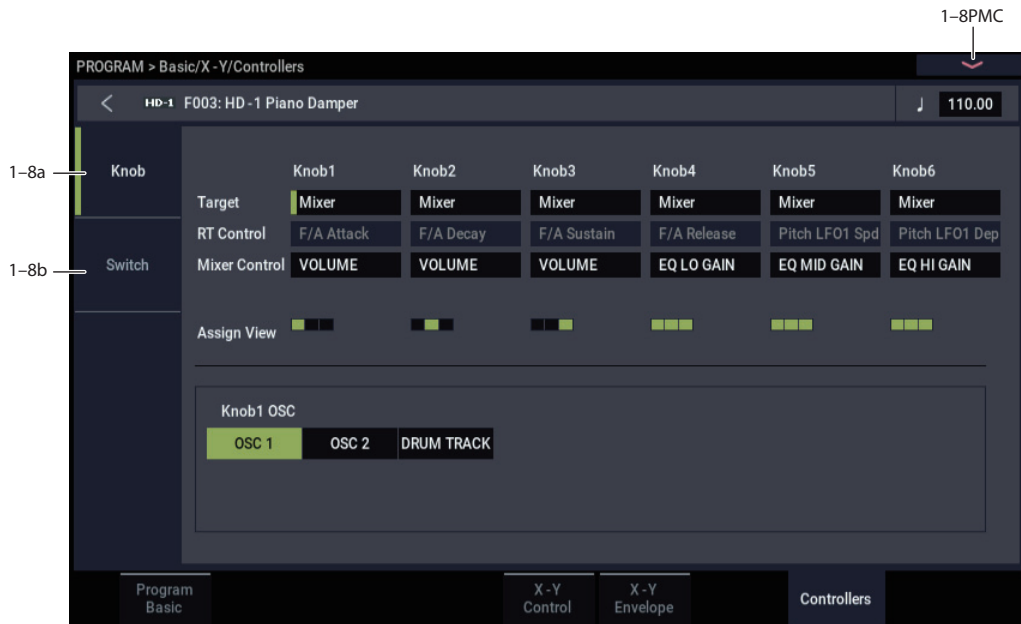

This page lets you set up the functionality of buttons 1 and 2 (SW1/2) and RT Control Knobs 1-6. These settings are made independently for each Program.

1-8a: RT Control Knob Assign

These settings assign functions (mainly MIDI control changes) to RT control knobs 1-6. For a complete list of the possible assignments, please see “RT Control Knobs 1-6 Assignments” on page 916.

The functions that you set here are enabled when you select a USER with the SELECT button and then operate the RT control knobs 1-6.

Knob1

Target [RT Control, Mixer]

Selects the function controlled by the knob.

RT Control: Controls the parameter that you have selected with RT Control.

Mixer Control: Controls the parameter that you have selected using Mixer Control.

RT Control [Off, ..., MIDI CC#119]

When the Target is “Mixer”, you can select the oscillator (OSC1, OSC2, DRUM TRACK) to be controlled.

Mixer Control [EQ TRIM, EQ LO GAIN, EQ MID GAIN, EQ MID FREQ, EQ HI GAIN, SEND1, SEND2, PAN, VOLUME, EXPRESSION]

1-8b: Panel Switch Assign

These settings control the functionality of SW1 and SW2.

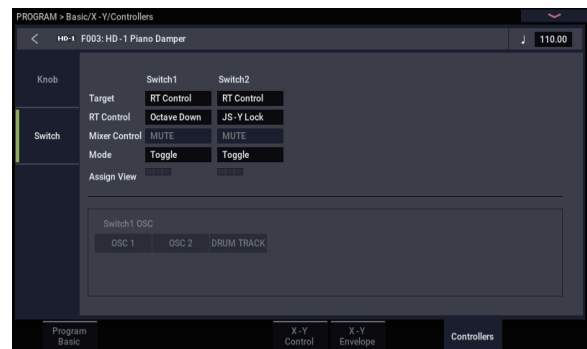

Target

Selects the function controlled by the switch.

RT Control: Controls the parameter that you have selected with RT Control.

Mixer Control: Controls the parameter that you have selected using Mixer Control.

RT Control [Off, ..., Soft (CC#67)]

When the Target is “Mixer”, you can select the oscillator (OSC1, OSC2, DRUM TRACK) to be controlled.

Mixer Control [Play/Mute, Solo]

Switch1 [Off, ..., Soft (CC#67)]

This assigns a function to the SW1 button. The on/off status can also be memorized. When you change the assignment, the button is set to the Off condition.

For a complete list of the possible assignments, please see “SW1/2 Assignments” on page 915.

Mode [Toggle, Momentary]

This specifies the mode of on/off when the SW1 button is pressed.

Toggle: The state will alternate between On and Off each time you press the SW1 button.

Momentary: The state will remain On only while you continue holding down the SW1 button.

Assign View

When the Target is “Mixer”, this selects the mixer channel to control. You can select multiple channels.

Switch2 [Off, ..., Soft (CC#67)]**Mode** [Toggle, Momentary]

This assigns a function to SW2. The functions that you can assign to SW2 are the same as for SW1, with the exception that the SW1 button’s SW1 Mod.:CC#80 assignment is replaced by SW2 Mod.:CC#81.

✓ 1-8: Page Menu Commands

- Compare →p.112
- Write Program →p.112
- Exclusive Solo →p.113
- Copy Oscillator →p.119
- Swap Oscillator →p.119

- PAGE →p.126
- MODE →p.126

PROGRAM > OSC/Pitch

These pages control the first and most basic elements of HD-1's sounds: the Multisamples that the oscillators play, and the pitch at which it plays them. For instance, you can:

- Select Multisamples and Wave Sequences for Single and Double Programs, or Drum Kits for Drum Programs.
- Set up velocity splits, crossfades, and layers for Single and Double Programs.

- Set the basic pitch of the sound, including the octave, fine tuning, and so on.
- Control pitch modulation from a wide variety of sources, such as JSX, LFOs, and the Pitch EG.

Note that when the **Oscillator Mode** is set to **Single** or **Drums**, only Oscillator 1's filters are active; the pages for Oscillator 2's filters will be grayed out.

2-1: OSC1 Basic



HD-1's sounds are based on samples, and this page lets you set up all of the basic sample-related settings. Among other things, you can:

- Select Multisamples and/or Wave Sequences for the Oscillator (in a Single or Double Program), or select the Drum Kit for a Drum Program
- Set the Oscillator's basic pitch
- Create velocity splits and crossfades between Multisamples and/or Wave Sequences

2-1a: OSC1 Frequency

Octave [-2[32'], -1[16'], +0[8'], +1[4']]

This sets the basic pitch of the Oscillator, in octaves. The default is +0[8']. The standard octave of a multisample is +0[8'].

Transpose [-12...+12]

This adjusts the pitch in semitones, over a range of ±1 octave.

Tune [-1200...+1200]

This adjusts the pitch in cents, over a range of ±1 octave. A cent is 1/100 of a semitone.

Frequency Offset [-10.0Hz ... +10.0Hz]

This adjusts the pitch by increments of 0.1 Hz. **Frequency Offset** is different from **Tune** in that, when used to detune the two oscillators, it can create a constant beat frequency across the range of the keyboard.

2-1b: Note-On Control

Delay [0000ms...5000ms, KeyOff]

Use this to create a delay between the time that you press a key, and the time that the note actually sounds.

This is most useful in Double Programs, for delaying one oscillator in relation to the other.

KeyOff is a special setting. Instead of delaying the sound by a particular amount of time, the sound will play as soon as you release the key. You can use this to create the "click" heard when a harpsichord note is released, for instance.

In general, when you use the **KeyOff** setting, it's also best to set the oscillator's Amp EG **Sustain Level** to 0.

Mode [Key, Key + Damper]

Normally, you play notes simply by pressing keys on the keyboard. In special cases, however, you can set this parameter so that you must first be holding down the damper pedal, and then press a key, in order to play a note. For instance, this can be useful when modeling the behavior of a piano soundboard.

Key is the normal mode.

When you select **Key + Damper**, notes will only sound if the damper pedal is being held down. When the damper pedal is released, all notes will be stopped—even if they are still being held down.

2-1c: OSC1 Multisample/Wave Sequence

The parameters in this section will change depending on the setting of the **Oscillator Mode** parameter.

In Single and Double modes, each Oscillator can play up to four Multisamples or Wave Sequences. In Drum mode, there is one Oscillator, and it plays a single Drum Kit.

Multisamples, Wave Sequences, and Drum Kits

Multisamples, Drum Kits, and Wave Sequences allow you to play samples in different ways.

- Multisamples lay out one or more samples across the keyboard. For instance, a very simple guitar Multisample might have six samples—one for each string.
- Wave Sequences play back a series of different Multisamples over time. These Multisamples may crossfade to create smooth, evolving timbres, or change abruptly to create rhythms.
- As the name suggests, Drum Kits are optimized for playing drum samples.

Velocity splits, crossfades, and layers

As mentioned above, unless you're in Drum mode, each Oscillator has eight velocity zones, named MS1 (High) through MS8 (Low). Each of these zones can play either a Multisample or a Wave Sequence, and has separate settings for Level, Start Offset, and so on.

Each of the zones can fade into the next, to create smoother velocity transitions. Zones can even be layered together, two at a time.

MS1 (High)

These are the settings for the first and highest velocity zone.

If you want to create a simple setup with only a single Multisample or Wave Sequence, just set up MS1 as desired, and then set the **Bottom Velocity** to 1 and the **Xfade Range** to 0.

Type [Off, Multisample, Wave Sequence]

This selects whether MS1 will play a Multisample, a Wave Sequence, or nothing at all.

The Type selection affects the choices shown in the Bank and Multisample menus.

Bank (Multisample) [List of Multisample Banks]

This menu will appear only if the **Type** is set to Multisample.

There are four types of Multisample Banks: **ROM**, **SAMPLING mode**, **EXs**, and **User Sample Banks**. For each type, you can also choose between looking at mono and stereo Multisamples. Note that stereo Multisamples will require twice as many voices as mono Multisamples.

ROM Multisamples are the built-in “factory” sounds, and are always available.

Smp (SAMPLING Mode) Multisamples are the ones that you can see and edit in SAMPLING mode. These may include Akai, SoundFont 2.0, AIFF or WAV files loaded

from drive, or native NAUTILUS samples (including third-party sound libraries and samples that you create yourself). Anything that can be used in SAMPLING mode can also be loaded as a User Sample Bank.

After the abbreviation “Smp,” several different things may appear, as described below.

Smp: Old RAM provides compatibility with older NAUTILUS sounds; it will appear in old Programs which used “RAM” samples, but cannot be selected for new Programs. Instead of pointing to a specific User Sample Bank, it will use whatever Multisample data is loaded into SAMPLING mode. This ensures that older Programs and sample data will continue to work as they did previously.

Smp: New Sampling Session will appear when there's data in SAMPLING mode which hasn't yet been saved to drive as a User Sample Bank. For instance, this might happen if you've loaded an old KSC file, loaded individual Samples or Multisamples, or recorded some new samples. Once the KSC is saved to drive, the name will update to show the file path (as described below).

Smp: [file name] will appear when a User Sample Bank has been loaded into SAMPLING mode. The name is the file name itself along with those of all its enclosing folders.

EXs Multisample banks are PCM expansion sets created especially for the NAUTILUS. Each has its own unique number; for instance, EXs301: German2 D Piano, EXs302: Italian F Piano. Only the currently loaded EXs banks will appear on this menu.

User Sample Banks bring the benefits of EXs to your own sample libraries. You can load and play gigabytes of your custom or converted samples at once, using Virtual Memory. The name is shown as a path to the KSC file, including the file name and the names of all enclosing directories. Only the currently loaded User Sample Banks will appear in this menu.

If a sound refers to a User Sample Bank which is not on the internal drive(s), the name will appear as “Unknown Sample Bank [number]” when the bank select dialog is open, shortened to “??[number]” when the dialog is closed.

For more information, see “User Sample Banks” on page 151 of the OG.

Multisample/Wave Sequence Select [List]

This parameter lets you select a Multisample or Wave Sequence, depending on the **Type** setting.

- 🔊 Some Multisamples may have an upper limit to their keyboard range, over which they may not produce any sound.

To select a Multisample or Wave Sequence:

1. Press the Multisample/Wave Sequence Select popup button to open the menu.

Within the window, ROM Multisamples are organized by categories; Wave Sequences are organized by bank; and EXs, User Sample Bank, and SAMPLING mode Multisamples appear as a continuous list.

- 2. For ROM Multisamples or Wave Sequences, use the tabs to select a category or bank.
- 3. Select a Multisample or Wave Sequence from the list.
- 4. You can use the Find button to search for Multisamples or Wave Sequences by name.

For more information, see “Find dialog” on page 7.

5. Press the OK button to confirm your selection, or press the Cancel button to exit without making a change.

Note: If the stored selection uses EXs, User Sample Bank, and SAMPLING mode data which is not currently loaded, it will not make any sound. The message “Samples Not Loaded” will also appear at the top of the display. To fix this, use the **Load required samples** menu command (see “Load required samples” on page 114).

Mono and Stereo Multisample lists for ROM and EXs

If ROM mono or any EXs mono Bank is selected, the list shows all of the mono Multisamples in the Bank. If the Bank contains stereo Multisamples, you’ll also see the left and right channels as separate, mono Multisamples, with -L and -R appended to the end of the name.

If ROM Stereo or any EXs Stereo Bank is selected, only stereo multisamples will be shown.

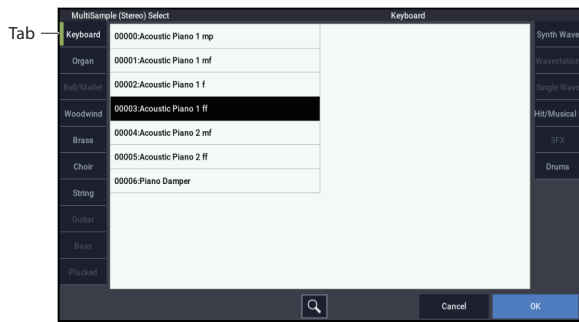

Mono and Stereo Multisample lists for SAMPLING mode and User Sample Banks

If SAMPLING mode mono or any mono User Sample Bank is selected, the list shows all of the mono Multisamples in the Bank. If the Bank contains stereo Multisamples, you’ll also see the left and right channels as separate, mono Multisamples, with -L and -R appended to the end of the name.

If SAMPLING mode stereo or any stereo User Sample Bank is selected, only the stereo Multisamples will appear. However, they will still be listed as separate left and right Multisamples. Selecting either the left or right channels will select the stereo pair.

Wave Sequence Select menu

Use the tabs to select a bank, and then select a Wave Sequence. Press the OK button to confirm your selection, or press the Cancel button to revert to the previous setting.

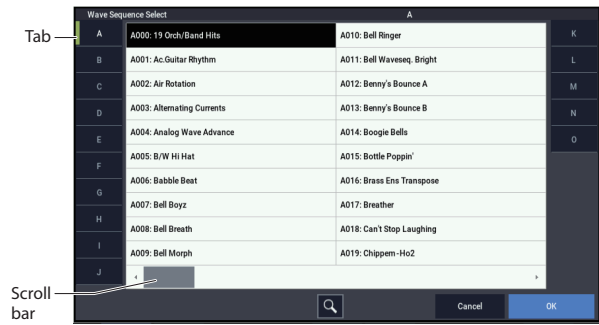

Reverse [Off, On]

This lets you play the selected multisample backwards, without looping. **Reverse** applies only to Multisamples; when the **Type** is set Wave Sequence, this is grayed out.

Note: If the individual samples within a Multisample are already set to Reverse, they will still play in reverse, regardless of this setting.

Note: Reverse is not available for EXs or User Sample Bank Multisamples loaded using Virtual Memory. To use reverse with this data, set the Load Method to RAM. For more information, see “Change load method” on page 644.

On (checked): The Multisample will play back in reverse.

Off (unchecked): The Multisample will play back normally.

Level [0...127]

This sets the basic volume level of the multisample. The Amp section can modify this basic level extensively with envelopes, LFOs, keyboard tracking, and other modulation; for more information, see “PROGRAM > Amp/EQ,” on page 74.

⚠ Depending on the multisample, high **Level** settings may cause distortion when playing many notes at a time. If this occurs, lower the **Level**.

With SAMPLING mode Multisamples, each Sample also has a **+12dB** option, configured in SAMPLING mode. If this is turned on, the Sample will play back approximately 12dB louder. For more information, see “+12dB” on page 590.

Start Offset [Off, 1st...8th]

In addition to simply starting playback from the beginning, ROM and EXs Multisamples can have up to 8 different pre-programmed alternate starting points.

Similarly, SAMPLING mode and User Sample Bank Multisamples can play either from the beginning of the waveform, or from the loop start point.

Start Offset applies only to Multisamples; when the **Type** is set Wave Sequence, this is grayed out.

Start Offsets: ROM and EXs

With ROM and EXs Multisamples, the Start Offset specifies whether to use the normal start point (**Off**), or to use one of the alternate start points (**1st–8th**).

Some ROM and EXs Multisamples may have fewer than 8 pre-programmed points, in which case only the available points can be selected.

Start Offsets: SAMPLING mode and User Sample Banks

With SAMPLING mode and User Sample Bank Multisamples, only Off and 1st are available. **Off** uses the normal start point, and **1st** uses the loop start instead. **2nd** through **8th** will be grayed out.

Bottom Velocity [1...127]

This sets the lowest velocity at which the Multisample or Wave Sequence will sound. MS1's Bottom Velocity can be equal to, but not lower than, than that of MS2.

Xfade Range [Off, 1...127]

This sets the range of velocities over which MS1 will fade into MS2, going up from the Bottom Velocity.

For instance, if the Bottom Velocity is set to 64, and the Xfade Range is set to 20, MS2 will start to fade in at velocities of 84 and below.

When velocities are within the Xfade Range, the Oscillator will use twice as much polyphony as it would normally.

Note: You can only fade between two zones at once.

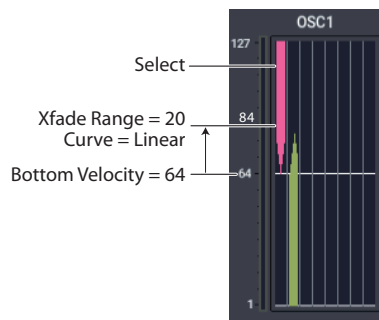

Curve [Linear, Power, Layer]

This controls the volume curve of the crossfade. **Linear** and **Power** (short for Equal Power) let you fine-tune the way that the two Multisamples mix together; one or the other may be more appropriate for a given pair of Multisamples. **Layer**, true to its name, lets you layer the two Multisamples together without any crossfading.

Crossfade Curves

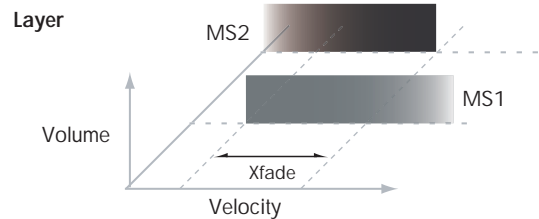
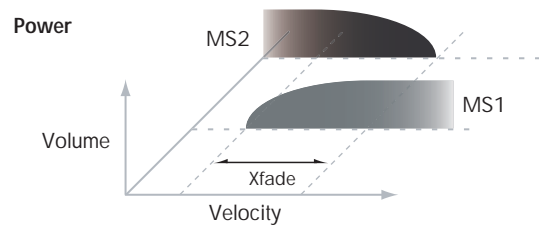
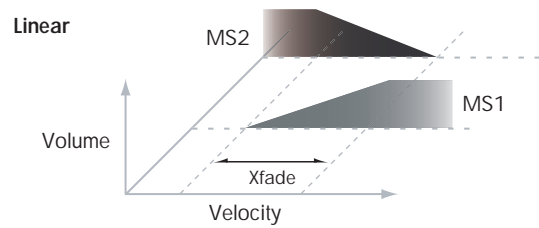

Linear means that the two samples will each be at 50% of their full volume in the middle of the crossfade. Sometimes, this may create a dip in the volume level; if so, try using **Power** instead.

Power, short for Equal Power, means that the two samples will each be at around 70% of their full volume in the middle of the crossfade. Sometimes, this may create a bump in the volume level, in which case you might try selecting **Linear** instead.

Layer means that the two Multisamples will be layered together, both at full volume, for the entire range of the crossfade.

MS2...7 and MS8 (Low)

These are the settings for the remaining velocity zones. The parameters for MS2...7 are exactly the same as those for "MS1 (High)," above.

The parameters for MS8 (Low) are also similar to those for MS1, except that MS8 has no settings for Bottom Velocity (which is always fixed at 1), Xfade Range, or Curve.

Velocity Graphic

The graphic on the right side of the display shows the velocity ranges and curves for the eight Multisamples. As you play on the keyboard, the graphic shows the Multisample(s) triggered by the most recent note.

2-1d: OSC 1 Velocity Zone

In addition to setting the velocity zones for each of the four Multisamples in a single Oscillator, you can also set high and low velocities for each of the two Oscillators as a whole.

These velocity zones take precedence over the velocity settings for the individual MS1-4.

Top [001...127]

This sets the highest velocity at which the Oscillator will sound.

Note: The Top velocity must be greater than the Bottom velocity.

Bottom [001...127]

This sets the lowest velocity at which the Oscillator will sound.

Entering velocity values from the keyboard

You can enter velocity values directly by playing them on the keyboard. To do so:

1. Select one of the Key parameters.
2. Hold down the ENTER key.
3. While holding ENTER, play a note on the keyboard at the desired velocity.

These parameters appear when the Oscillator Mode is set to Drum Kit.

2-1e: Drum Kit Frequency

Octave [-2[32'], -1[16'], +0[8'], +1[4']]

This adjusts the pitch in octave units. When using a drum kit, set the Octave to 8'.

 When editing a drum program, you must set this parameter to 8'. With other settings, the sounds of the drum kit will be assigned to the wrong notes of the keyboard.

Transpose [-12...+12]

This adjusts the location of the instruments in the selected drum kit. Unless you need to change this, leave it at 0.

Tune [-1200...+1200]

This adjusts the pitch in one-cent units.

The pitch of each drum kit can be adjusted in GLOBAL > Drum Kit.

Delay [0ms...5000ms, KeyOff]

Use this to create a delay between the time that you press a key, and the time that the note actually sounds.

KeyOff is a special setting. Instead of delaying the sound by a particular amount of time, the sound will play as soon as you release the key.

In general, when you use the **KeyOff** setting, it's also best to set the oscillator's Amp EG **Sustain Level** to 0.

2-1f: Drum Kit

Drum Kit [A...O]

This selects a drum kit for the Oscillator. Drum Kits allow each note to have up to 8 different velocity-crossfaded Drum Samples, along with per-note settings for volume, pan, effects routing, and more.

When the Drum Kit Select window is open, you can use the Find button to search for Drum Kits by name. For more information, see "Find dialog" on page 7.

Drum Kits are edited in GLOBAL mode. For more information, see "GLOBAL > Drum Kit" on page 667 and "Using Drum Kits" on page 193 of the OG.

✓ 2-1: Page Menu Commands

- Compare →p.112
- Write Program →p.112
- Exclusive Solo →p.113
- Copy Oscillator →p.119
- Swap Oscillator →p.119
- Sample Parameters →p.119
- Remap MS/Sample Banks →p.121.
- PAGE →p.126
- MODE →p.126

2-2: OSC1 Pitch

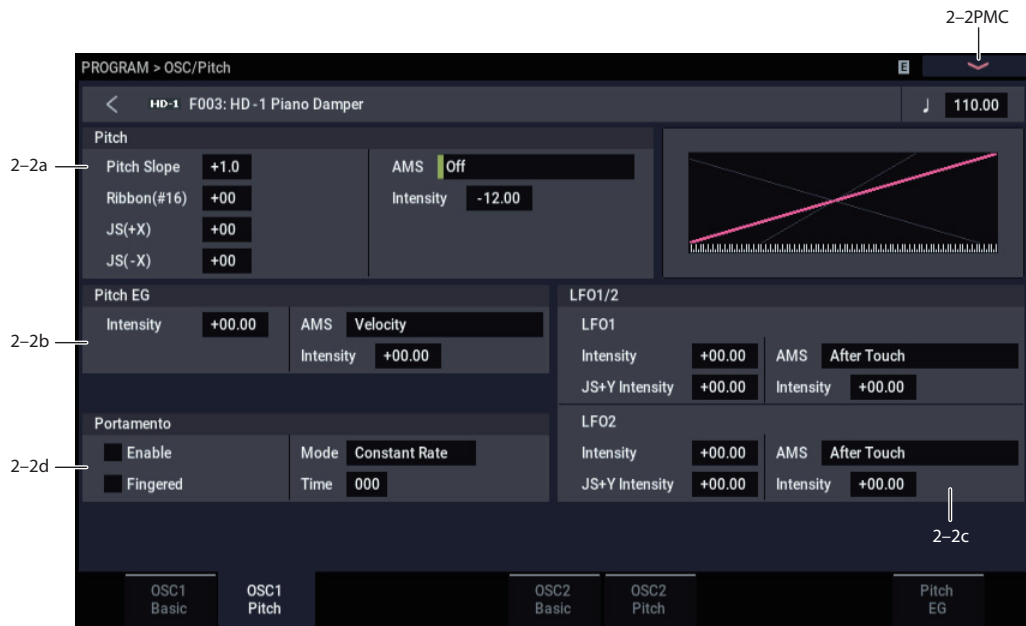

This page contains all of the settings for Oscillator 1's pitch modulation. For example, you can:

- Set up pitch bend from Joystick X (with separate settings for bending up and bending down).
- Use Pitch Slope to control how the pitch changes when you play up and down the keyboard.
- Set up Portamento.
- Assign AMS modulation for pitch.
- Set up initial amounts of pitch modulation from the Pitch EG and LFO1/2, as well as AMS modulation of LFO and EG amounts.

2-2a: Pitch

Pitch Slope [-1.0...+2.0]

Normally, this should be set to the default of +1.0.

Positive (+) values cause the pitch to rise as you play higher on the keyboard, and **negative (-)** values cause the pitch to *fall* as you play higher on the keyboard.

When this is set to **0**, playing different notes on the keyboard won't change the pitch at all; it will be as if you're always playing C4. This can be useful for special effects sounds, for instance.

Pitch Slope, pitch, and note

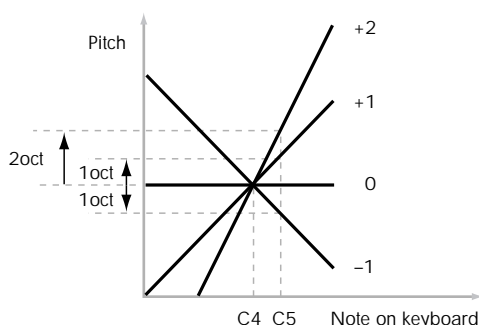

JS (+X) [-60...+12]

This sets the maximum amount of pitch bend, in semitones, when you move the joystick to the right. For normal pitch bend, set this to a positive value.

For example, if you set this to +12 and move the joystick all the way to the right, the pitch will rise one octave above the original pitch.

JS (-X) [-60...+12]

This sets the maximum amount of pitch bend, in semitones, when you move the joystick to the left. For normal pitch bend, set this to a negative value.

For example, if you set this to -60 and move the joystick all the way to the left, the pitch will fall five octaves below the original pitch. You can use this to create guitar-style downward swoops.

AMS (Pitch) [List of AMS Sources]

This selects a modulation source to control the pitch. For a list of AMS sources, see "Alternate Modulation Source (AMS) List" on page 903.

Intensity [-12.00...+12.00]

This controls the depth and direction of the pitch modulation, in semitones. When this is set to "12.00," the pitch will change over one octave.

2-2b: Pitch EG

Intensity [-12.00...+12.00]

This controls the initial effect of the Pitch EG on Oscillators 1's frequency, in half-steps, before any AMS modulation.

The Pitch EG's shape can swing all the way from +99 to -99. When the Intensity is set to a **positive (+)** value, positive values from the EG raise the pitch, and negative values lower the pitch.

When the Intensity is set to a **negative (-)** value, the effect of the EG is reversed; positive EG values mean *lower* pitches, and negative EG values mean *higher* pitches.

AMS (Pitch EG) [List of AMS Sources]

This selects any AMS modulation source to scale the amount of the Pitch EG applied to the pitch.

For a list of AMS sources, see “Alternate Modulation Source (AMS) List” on page 903.

Intensity [-12.00...+12.00]

This controls the depth and direction of the pitch EG AMS modulation. The AMS modulation and the initial Intensity are added together to determine the Pitch EG’s final effect.

With **positive (+) values**, greater modulation will increase the effect of the Pitch EG, as shown in example **B** below.

Pitch EG AMS

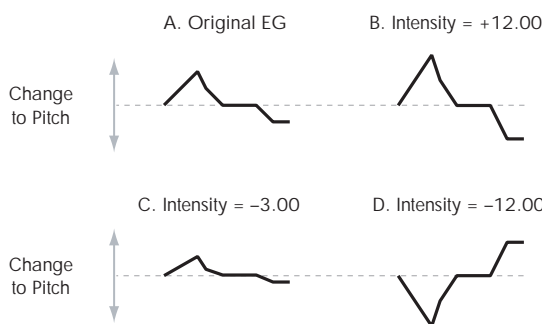

With **negative (-) values**, greater modulation will introduce the *opposite* effect of the Pitch EG—like inverting the polarity of the envelope. You can use this in several different ways:

- You can set an initial positive amount with the Intensity parameter, and then reduce this amount with AMS. In this case, the final effect of the EG is simply diminished, and not actually inverted, as shown in example **C**.
- You can also set the AMS Intensity amount to be greater than the initial Intensity. In this case, the EG will have a positive effect with low modulation amounts, and an inverted effect at higher modulation amounts—as shown in example **D**.

2-2c: LFO1/2

LFO1 and LFO2 can both modulate the pitch. You can control the strength of each LFO’s modulation in three different ways:

- Set an initial amount of LFO modulation, using the LFO 1/2 Intensity parameters.
- Use JS+Y to scale the amount of the LFO.
- Use any AMS source to scale the amount the LFO.

You can use each of these methods for each of the two LFOs. The results are added together to produce the total LFO effect.

LFO1

LFO1 Intensity [-12.00...+12.00]

This controls the initial effect of the LFO on the pitch, in semitones, before any JS+Y or AMS modulation.

Negative (-) settings will invert the phase of the LFO.

JS+Y Intensity (LFO1 JS+Y Int.) [-12.00...+12.00]

Moving the joystick “up” from the center detent position, away from yourself, produces the JS+Y controller. You can use this to scale the amount of the LFO applied to the pitch. This parameter sets the maximum amount of LFO modulation added by JS+Y, in semitones.

As this value is **increased**, moving the joystick in the +Y direction will cause the OSC1 LFO1 to produce deeper pitch modulation.

Negative (-) settings will invert the phase of the LFO. You can also use this to reduce the initial amount of the LFO, as set by **LFO1 Intensity**, above. For example:

1. Set LFO1 Intensity to +7.00.

The LFO will now have a fairly strong effect on the pitch, bending it by a perfect 5th.

2. Set JS+Y Intensity to -7.00.

Now, if you move the joystick up, the effect of the LFO will fade away. When the joystick is all the way at the top of its range, the LFO will be completely canceled out.

AMS (LFO1) [List of AMS Sources]

This selects any AMS modulation source to scale the amount of the LFO applied to pitch.

For a list of AMS sources, see “Alternate Modulation Source (AMS) List” on page 903.

Intensity [-12.00...+12.00]

This controls the depth and direction of the LFO AMS modulation for pitch.

For example, if **AMS** is set to **After Touch**, **positive** settings mean that aftertouch will increase the amount of pitch modulation from LFO1.

LFO2

The parameters for LFO2 are identical to those for LFO1. For more information, see the descriptions under LFO1, above.

2-2d: Portamento

Portamento lets the pitch glide smoothly between notes, instead of changing abruptly.

Enable [Off, On]

On (checked): Turns on Portamento, so that pitch glides smoothly between notes.

Off (unchecked): Turns off Portamento. This is the default state.

Fingered [Off, On]

This parameter allows you to control Portamento through your playing style. When it’s enabled, playing legato will turn on Portamento, and playing detached will turn it off again.

This option is only available when Portamento Enable is turned on.

On (checked): Turns on Fingered Portamento.

Off (unchecked): Turns off Fingered Portamento.

Mode [Constant Rate, Constant Time]

Constant Rate means that Portamento will always take the same amount of time to glide a given distance in pitch - for instance, one second per octave. Put another way, gliding several octaves will take much longer than gliding a half-step.

Constant Time means that Portamento will always take the same amount of time to glide from one note to another, regardless of the difference in pitch. This is especially useful when playing chords, since it ensures that each note in the chord will end its glide at the same time.

Time [000...127]

This controls the portamento time. Higher values mean longer times, for slower changes in pitch.

This option is only available when Portamento Enable is turned on.

Assigning SW1 or SW2 to Portamento On/Off

You can use the two assignable switches, SW1 and SW2, to turn portamento on and off.

To do so:

1. Go to the PROGRAM > Basic/X-Y/Controllers-Switch page.
2. Under Switch, set either Switch1 or Switch2 to Portamento SW (CC#65).

Now, the selected button will enable and disable Portamento. It will also send the MIDI Portamento controller, CC#65.

MIDI Even if you don't assign SW1/2 to Portamento, you can still use MIDI Controller #65 to turn Portamento on and off.

✓ 2-2: Page Menu Commands

- Compare →p.112
- Write Program →p.112
- Exclusive Solo →p.113
- Copy Oscillator →p.119
- Swap Oscillator →p.119
- PAGE →p.126
- MODE →p.126

2-5: OSC2 Basic

This page controls the basic settings for Oscillator 2. It is available only when the **Oscillator Mode** is set to **Double**; if not, the page will be grayed out.

The parameters are identical to those for Oscillator 1, as described under "2-1: OSC1 Basic," on page 50.

2-6: OSC2 Pitch

This page controls the pitch settings for Oscillator 2. It is available only when the **Oscillator Mode** is set to **Double**; if not, the page will be grayed out.

The parameters are identical to those for Oscillator 1, as described under "2-2: OSC1 Pitch," on page 55.

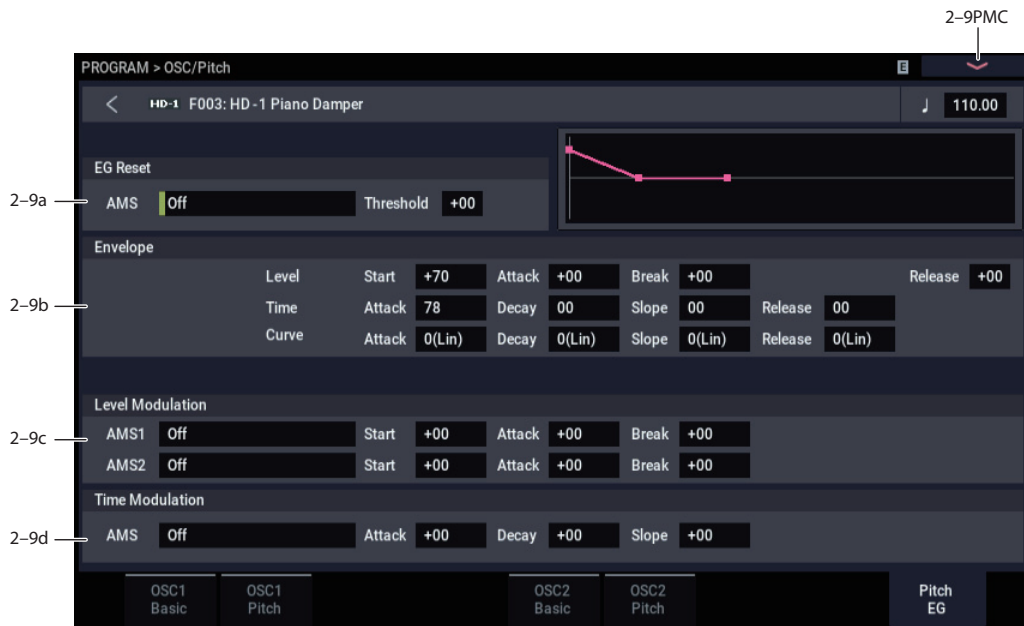
2-9: Pitch EG AMSource

The Pitch EG, or Envelope Generator, lets you create complex, time-varying changes to the pitch of Oscillators 1 and 2. The parameters on this page control the shape of the EG. For instance, you can:

- Create the basic EG shape by setting the levels and times of each segment.
- Control the curvature of each EG segment, for subtle control over the sound of the EG.
- Set up complex modulation of EG levels and times.
- Set up an AMS source, such as an LFO, to restart the EG.

To control how much effect the EG has on the pitch, use the Pitch EG parameters on the OSC/Pitch– OSC1(2) Pitch page, as described under “2-2b: Pitch EG,” on page 55.

Differences from the other EGs

The Pitch EG is different from the Filter and Amp EGs in several ways:

- The single Pitch EG is shared by both Oscillator 1 and Oscillator 2.
- The Sustain level is always 0.
- The Level modulation has two AMS sources instead of one, and the Time modulation has one AMS source instead of three.

Pitch EG is also an AMS source

You can use the Pitch EG as an AMS source to modulate other parameters, just like the keyboard tracking and LFOs. Simply select the Pitch EG in the AMS list for the desired parameter.

2-9a: EG Reset

AMS (EG Reset AMS) [List of AMS Sources]

This selects an AMS source to reset the EG to the start point. For instance, you can use a tempo-synced LFO to trigger the EG in a repeating rhythm. This reset is in addition to the initial note-on, which always causes the EG to start.

For a list of AMS sources, see “Alternate Modulation Source (AMS) List” on page 903.

Threshold [–99...+99]

This sets the AMS level which will trigger the EG reset. Among other things, you can use this to adjust the exact point in an LFO’s phase at which the EG will be reset, effectively controlling its “groove” against other rhythmic effects.

When the threshold is **positive**, the EG triggers when passing through the threshold moving upwards. When the threshold is **negative**, the EG triggers when passing through the threshold moving downwards.

Note: With some LFO shapes, and with faster LFO speeds, the LFO may not always reach the extreme values of +99 or -99. In this case, setting the **Threshold** to these values may cause inconsistent behavior, or may mean that the EG doesn’t reset at all. If this happens, reduce the **Threshold** until the EG triggers consistently.

2-9b: Envelope

Pitch EG

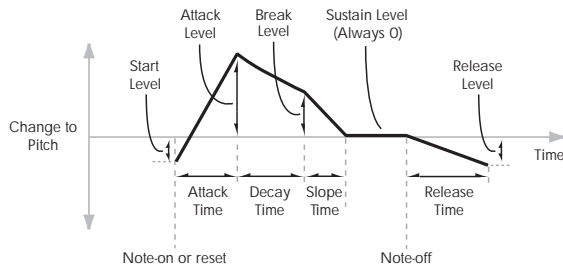

An envelope creates a modulation signal by moving from one level to another over a specified time, and then moving to another level over another period of time, and so on.

The parameters below let you set four levels, the amount of time it takes to go from each of the levels to the next, and the shape (from linear to curved) of each transition.

Level

Each of the four levels can be either positive or negative.

Positive levels will make the pitch (or other AMS destination) go up from its programmed value; **negative** levels will make it go down.

Note that, unlike the Filter and Amp EGs, the Pitch EG's Sustain Level is always 0.

Start [-99...+99]

This sets the initial EG level, at note-on.

Attack [-99...+99]

This sets the level at the end of the Attack time.

Break [99...+99]

Break, short for Break Point, sets the level at the end of the Decay time.

Release [-99...+99]

This sets the level at the end of the Release time.

Time

Higher values mean longer times, as shown below:

| EG Value | Actual Time |
|----------|--------------|
| 00 | 0.667 ms |
| 10 | 10 ms |
| 20 | 44 ms |
| 30 | 104 ms |
| 40 | 224 ms |
| 50 | 464 ms |
| 60 | 944 ms |
| 70 | 1.8 seconds |
| 80 | 3.8 seconds |
| 90 | 10.9 seconds |
| 99 | 87.3 seconds |

Attack [00...99]

This sets how long the EG takes to move from the Start level to the Attack level.

The minimum attack time is 2/3 of a millisecond—as fast as the most punchy of classic analog synths.

For the fastest possible attack time, you can set the Start level to +99; in this case, the EG will start instantaneously at its maximum value.

Decay [00...99]

This sets the time it takes to move from the Attack level to the Break level.

Slope [00...99]

This sets how long the EG takes to move from the Break level to the Sustain level (which for the Pitch EG is always 0). Once it reaches the Sustain, the EG will stay there until note-off, unless it is reset via AMS.

Release [00...99]

This sets how long it takes the EG to move from the Sustain level to the Release level.

Curve

For the sake of simplicity, most of the diagrams in this manual show envelopes as being made out of straight lines. In actuality, though, envelopes are more likely to be made out of curves.

In other words, each segment's level will change quickly at first, and then slow down as it approaches the next point. This tends to sound better than straight, linear segments.

Classic analog synth envelopes made these curved shapes naturally. The NAUTILUS goes a step further than vintage synths, however, and lets you control the amount of curvature separately for each of the four envelope segments.

When you change the curvature, the EG times remain the same. However, greater curvature will tend to *sound* faster, because the value changes more quickly at the beginning.

Pitch EG Curve

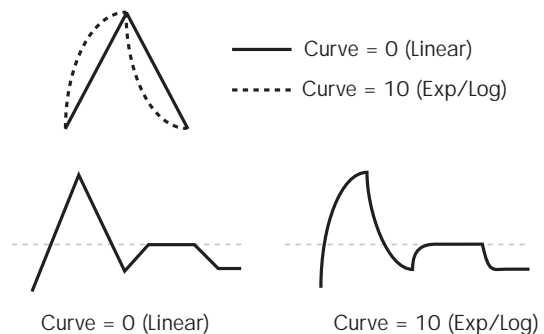

Different curve settings for up and down

You may find that different amounts of curvature are suitable for segments which go up and segments which go down.

For instance, a curve of 3 is a good default setting for upward segments, such as Attack. On the other hand, a curve of 6 or more is good for downward segments, such as Decay and Release.

Attack [0 (Linear), 1...9, 10 (Exp/Log)]

This sets the curvature of the Attack segment - the transition from the Start level to the Attack level.

Decay [0 (Linear), 1...9, 10 (Exp/Log)]

This sets the curvature of the Decay segment - the transition from the Attack level to the Break level.

Slope [0 (Linear), 1...9, 10 (Exp/Log)]

This sets the curvature of the Slope segment - the transition from the Break level to the Sustain level (which for the Pitch EG is always 0).

Release [0 (Linear), 1...9, 10 (Exp/Log)]

This sets the curvature of the Release segment - the transition from the Sustain level to the Release level.

2-9c: Level Modulation

These settings let you use two different AMS sources to control the Level parameters of the EG. For each of the two AMS sources, the Start, Attack, Decay, and Break levels each have their own modulation intensities.

By using different settings for each of the three levels, you can cause both subtle and dramatic changes to the EG shape, as shown below.

Note: Once the EG has started a segment between two points, that segment can no longer be modulated. This includes both the time of the segment, and the level reached at the end of the segment.

For instance, if the EG is in the middle of the Decay time, you can no longer modulate either the Decay time or the Break level.

This also means that modulating the Start level, Attack level, or Attack time will not affect notes that are already sounding, unless the EG is then re-started via EG Reset.

Pitch EG Level Modulation

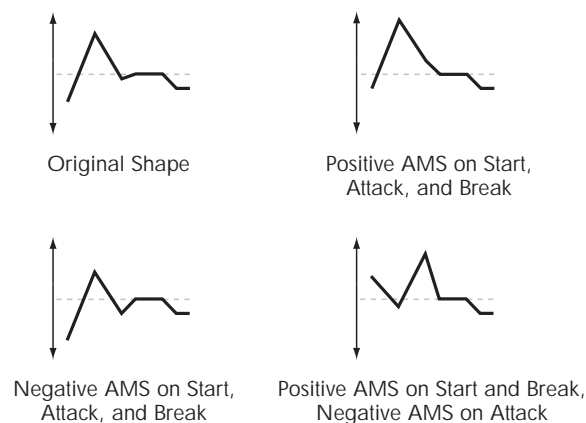

AMS1 [List of AMS Sources]

This selects the first AMS source to control the EG's Level parameters.

For a list of AMS sources, see "Alternate Modulation Source (AMS) List" on page 903.

Start [-99...+99]

This controls the depth and direction of the AMS modulation for the Start level.

For example, if you set the AMS source to Velocity and set Start to +99, the Start level will increase as you play harder. If you instead set Start to -99, the Start level will decrease as you play harder.

Attack [-99...+99]

This controls the depth and direction of the AMS modulation for the Attack level.

Break [-99...+99]

This controls the depth and direction of the AMS modulation for the Break level.

AMS2

This selects the second AMS source for controlling the EG's Level parameters. The Start, Attack, Decay, and Break levels share this source, but each has its own modulation intensity. The parameters of AMS2 are identical to those of AMS1, above.

2-9d: Time Modulation

These settings let you use an AMS source to control the Time parameters of the EG. The Attack, Decay, Slope, and Release times share this AMS source, but each has its own modulation intensity.

Pitch EG Time Modulation

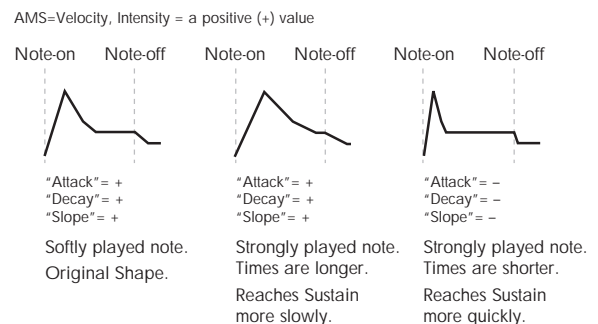

AMS [List of AMS Sources]

This selects the AMS source to control the EG's Time parameters. Velocity and Keyboard Track can both be useful here, for instance.

For a list of AMS sources, see "Alternate Modulation Source (AMS) List" on page 903.

Attack [-99...+99]

This controls the depth and direction of the AMS modulation for the Attack time.

For example, if you set the AMS source to Velocity and set Attack to +99, the Attack time will get much longer at higher velocities. If you instead set Attack to -99, the Attack time will get much shorter at higher velocities.

When the AMS source is at its maximum value—for instance, when Velocity is at 127—a setting of +8 will make the Attack time almost twice as long, and a setting of -8 will cut the Attack time almost in half.

Decay [-99...+99]

This controls the depth and direction of the AMS modulation for the Decay time.

Slope

[-99...+99]

This controls the depth and direction of the AMS modulation for the Slope time.

✓ 2-9: Page Menu Commands

- Compare →p.112
- Write Program →p.112
- Exclusive Solo →p.113
- Copy Oscillator →p.119
- Swap Oscillator →p.119

- PAGE →p.126
- MODE →p.126

PROGRAM > Filter

Filtering can make subtle or dramatic changes to the oscillator's timbre. Each oscillator has two multimode resonant filters, A and B, as well as a dedicated filter envelope and keyboard tracking generator.

These pages let you control all aspects of the filters. Among other things, you can:

- Make basic settings for each oscillator's filters, including routing, modes, cutoff, resonance, etc.
- Set up filter modulation, including keyboard tracking, the filter envelope, LFO modulation, and AMS control.

Note that when the **Oscillator Mode** is set to **Single**, only Oscillator 1's filters are active; the pages for Oscillator 2's filters will be grayed out.

3-1: Filter1



This page contains all of the basic settings for Oscillator 1's Filter A and Filter B. For example, you can:

- Set up the filters to produce a single 12dB/oct filter, dual 12dB/oct filters in either serial or parallel routing, or a single 24dB/oct filter.
- Set each of the two filters to Low Pass, High Pass, Band Pass, or Band Reject modes.
- Set the cutoff, resonance, and input and output levels of each filter, including modulation of resonance and output level.

3-1a: Filter Routing

Filter Routing [Single, Serial, Parallel, 24dB (4-Pole)]

Each oscillator has two filters, Filter A and Filter B. This parameter controls whether one or both of the filters are used, and if both are used, it controls how they are connected to each other.

Single. This uses only Filter A as a single 2-pole, 12dB/octave filter (6dB for Band Pass and Band Reject). When this option is selected, the controls for Filter B will be grayed out.

Serial. This uses both Filter A and Filter B. The oscillator first goes through Filter A, and then the output of Filter A is processed through Filter B.

Parallel. This also uses both Filter A and Filter B. The oscillator feeds both filters directly, and the outputs of the two filters are then summed together.

24dB (4-Pole). This merges both filters to create a single 4-pole, 24dB/octave filter (12dB for Band Pass and Band Reject). In comparison to Single, this option produces a sharper roll-off beyond the cutoff frequency, as well as a slightly more delicate resonance. Many classic analog synths used this general type of filter.

When 24dB (4-Pole) is selected, only the controls for Filter A are active; the controls for Filter B will be grayed out.

Serial and Parallel Routing

Serial

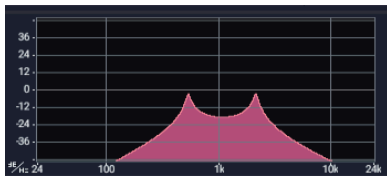

Parallel

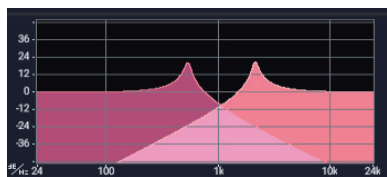
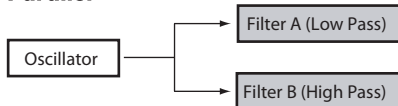

12db/oct / 24db/oct

Low Pass:
12dB/oct

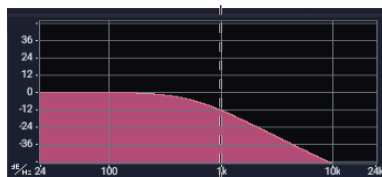

Low Pass:
24dB/oct

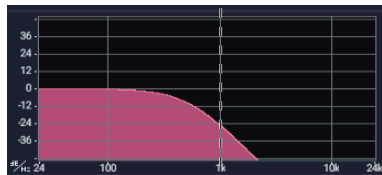

With low resonance settings, you can use the Band Pass filter to create telephone or vintage phonograph sounds. With higher resonance settings, it can create buzzy or nasal timbres.

Band Reject. This filter type—also called a notch filter—cuts only the parts of the sound directly around the cutoff frequency. Try modulating the cutoff with an LFO to create phaser-like effects.

Filter Types and Cutoff Frequency

Low Pass

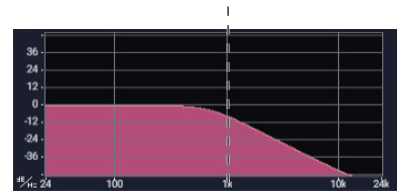

High Pass

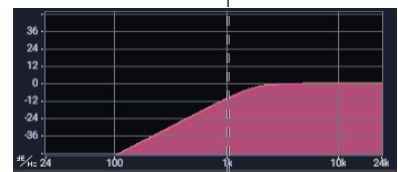

Band Pass

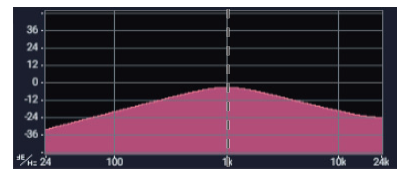

Band Reject

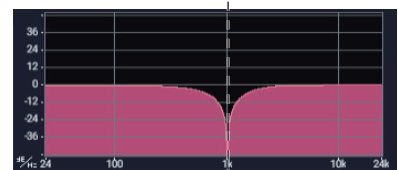

Cutoff Frequency

3-1b: Filter A

Filter Type

[Low Pass, High Pass, Band Pass, Band Reject]

The filter will produce very different results depending on the selected filter type. The selections will change slightly according to the selected **Filter Routing**, to show the correct cutoff slope in dB per octave.

Low Pass. This cuts out the parts of the sound which are **higher** than the cutoff frequency. Low Pass is the most common type of filter, and is used to make bright timbres sound darker.

High Pass. This cuts out the parts of the sound which are **lower** than the cutoff frequency. You can use this to make timbres sound thinner or more buzzy.

Band Pass. This cuts out all parts of the sound, both highs and lows, except for the region around the cutoff frequency. Since this filter cuts out both high and low frequencies, its effect can change dramatically depending on the cutoff setting and the oscillator's multisample.

Bypass

[Off, On]

This lets you bypass Filter A completely.

If **Bypass** is **Off**, Filter A functions normally.

When **Bypass** is **On**, Filter A has no effect on the input signal.

Frequency

[00...99]

This controls the cutoff frequency of Filter A, in increments of 1/10 of an octave. The specific effect of the cutoff frequency will change depending on the selected **Filter Type**, as described above.

Input Trim

[00...99]

This adjusts the volume level at the input to the filter. If you notice that the sound is distorting, especially with high **Resonance** settings, you can turn the level down here, or at the Output Level.

Note: The filter will not clip internally, so there is no difference between adjusting the **Input Trim** and the **Output Level**. Either of these controls will allow you to minimize clipping later in the signal chain, such as may occur in the Drive section and in some effects.

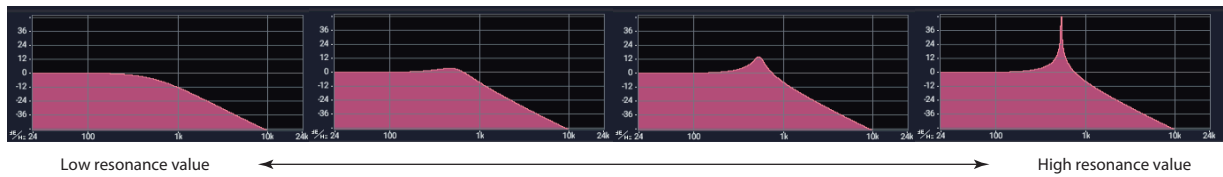
Resonance**Resonance** [00...99]

Resonance emphasizes the frequencies around the cutoff frequency.

When this is set to 0, there is no emphasis, and frequencies beyond the cutoff will simply diminish smoothly.

At medium settings, the resonance will alter the timbre of the filter, making it sound more nasal, or more extreme.

At very high settings, the resonance can be heard as a separate, whistling pitch.

To make the resonance track the keyboard pitch, see “Key Follow,” on page 67.

AMS (Resonance) [List of AMS Sources]

This selects a modulation source to control the Resonance amount. For a list of AMS sources, see “Alternate Modulation Source (AMS) List” on page 903.

Intensity [-99...+99]

This controls the depth and direction of the Resonance modulation.

For example, if Velocity has been selected, changes in keyboard velocity will affect the resonance. With positive (+) values, the resonance will increase as you play more strongly, and as you play more softly the resonance will approach the level specified by the **Resonance** setting. With negative (-) values, the resonance will decrease as you play more strongly, and as you play more softly the resonance will approach the level specified by the **Resonance** setting.

The resonance level is determined by adding the **Resonance** and **Intensity** values.

Output Level [00...99]

This controls the output level of Filter A. You can use this to balance the volumes of Filters A and B when the **Routing** is set to Parallel, or to turn down the volume to avoid clipping later in the signal chain.

AMS (Output Level) [List of AMS Sources]

This selects a modulation source to control the output level of Filter A. For a list of AMS sources, see “Alternate Modulation Source (AMS) List” on page 903.

Intensity [-99...+99]

This controls the depth and direction of the output level modulation.

3-1: Page Menu Commands

- Compare →p.112
- Write Program →p.112
- Exclusive Solo →p.113
- Copy Oscillator →p.119
- Swap Oscillator →p.119
- PAGE →p.126
- MODE →p.126

3-1c: Filter B

Filter B is available when the **Filter Routing** is set to **Serial** or **Parallel**. Otherwise, the parameters in this section will be grayed out.

The parameters for Filter B are identical to those for Filter A. For more information, see the descriptions under Filter A, above.

3-2: Filter1 Mod.

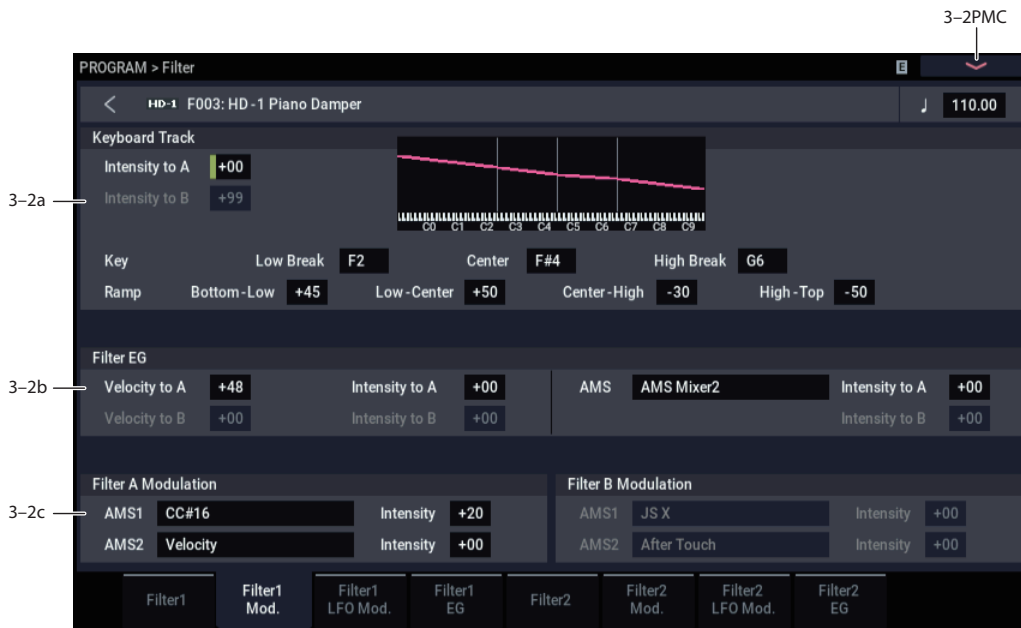

This page contains the settings for Oscillator 1’s filter modulation. Among other things, you can:

- Set up complex keyboard tracking shapes, and control how the tracking affects filter cutoff.
- Control the effect of the Filter Envelope on filter cutoff.
- Assign AMS modulation for filter cutoff.

Filter B is available when the **Filter Routing** is set to **Serial** or **Parallel**. Otherwise, the parameters for Filter B will be grayed out.

3-2a: Keyboard Track AMSource

Most acoustic instruments get brighter as you play higher pitches. At its most basic, keyboard tracking re-creates this effect by increasing the cutoff frequency of a lowpass filter as you play higher on the keyboard. Usually, some amount of key tracking is necessary in order to make the timbre consistent across the entire range.

The NAUTILUS keyboard tracking can also be much more complex, since it allows you to create different rates of change over up to four different parts of the keyboard. For instance, you can:

Filter Keyboard Tracking

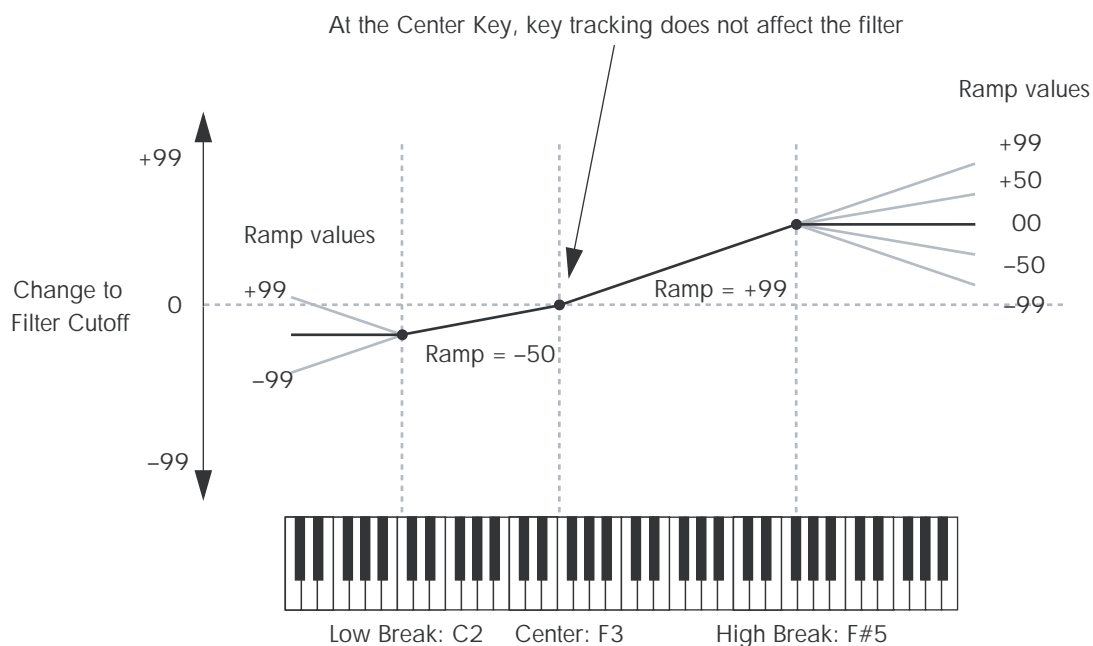

- Make the filter cutoff increase very quickly over the middle of the keyboard, and then open more slowly—or not at all—in the higher octaves.
- Make the cutoff increase as you play *lower* on the keyboard.
- Create abrupt changes at certain keys, for split-like effects.

How it works: Keys and Ramps

The keyboard tracking works by creating four ramps, or slopes, between five keys on the keyboard. The bottom and top keys are fixed at the bottom and top of the MIDI range, respectively. You can set the other three keys—named **Low Break**, **Center**, and **High Break**—to be anywhere in between.

The four Ramp values control the rate of change between each pair of keys. For instance, if the **Low-Center** Ramp is set to 0, the value will stay the same between the **Low Break** key and the **Center** key.

You can think of the resulting shape as being like two folding doors attached to a hinge in the center. At the **Center** key (the main hinge), the keyboard tracking has no effect. The two folding doors swing out from this center point to create changes in the higher and lower ranges of the keyboard.

Intensity to A [-99...+99]

This controls how much the keyboard tracking will affect Filter A’s cutoff frequency. The overall effect of the Keyboard Track is a combination of this Intensity value and the overall Keyboard Track shape.

With **positive values (+)**, the effect will be in the direction specified by keyboard tracking; if the ramp goes up, the filter cutoff will **increase**.

With **negative values (-)**, the effect will be in the opposite direction; if the ramp goes up, the filter cutoff will *decrease*.

Intensity to B [-99...+99]

This controls how much the keyboard tracking will affect Filter B’s cutoff frequency.

Key

Low Break [C-1...G9]

This sets the breakpoint note between the two lower ramps - the “hinge” of the lower door.

Center [C-1...G9]

This sets the center of the keyboard tracking - the main “hinge.” At this key, the keyboard tracking has no effect on the filter cutoff, or on any AMS destinations.

High Break [C-1...G9]

This sets the breakpoint note between the two higher ramps - the “hinge” of the upper door.

Entering notes from the keyboard

You can enter note numbers directly by playing them on the keyboard. To do so:

1. Select one of the Key parameters.
2. Hold down the ENTER key.
3. While holding ENTER, play a note on the keyboard.

Keyboard Track Shape and Intensity

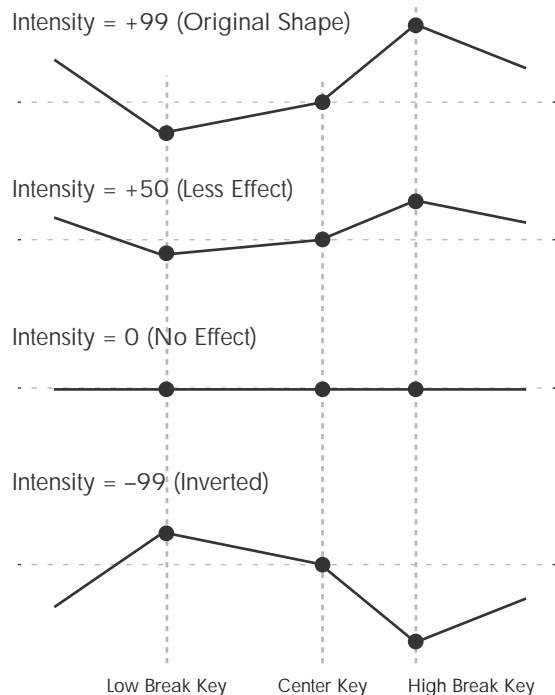

Ramp

Positive ramp values mean that the keyboard tracking output increases as you play farther from the **Center Key**; negative ramp values mean that it decreases.

Because of this, the meanings of positive and negative ramp settings will change depending on whether the ramp is to the left or right of the **Center Key**.

Bottom-Low and Low-Center: negative ramps make the keyboard tracking’s output go down as you play lower on the keyboard, and positive ramps make the output go higher.

Center-High and High-Top: negative ramps make the keyboard tracking’s output go down as you play *higher* on the keyboard, and positive ramps make the output go up.

The effect on the filter cutoff is a combination of the ramp values, as set below, and the Intensity to A and B parameters. When Intensity is set to +99, a ramp of 50 changes the filter frequency by 1 octave for every octave of the keyboard, and a ramp of +99 changes the frequency by 2 octaves for every octave of the keyboard.

Bottom-Low [-Inf, -99...+99, +Inf]

This sets the slope between the bottom of the MIDI note range and the Low Break key. For normal key track, use negative values.

Low-Center [-Inf, -99...+99, +Inf]

This sets the slope between the Low Break and Center keys. For normal key track, use negative values.

Center-High [-Inf, -99...+99, +Inf]

This sets the slope between the Center and High Break keys. For normal key track, use positive values.

High-Top [-Inf, -99...+99, +Inf]

This sets the slope between the High Break key and the top of the MIDI note range. For normal key track, use positive values.

+Inf and -Inf ramps

+Inf and -Inf are special settings which create abrupt changes for split-like effects. When a ramp is set to +Inf or -Inf, the keyboard tracking will go to its extreme highest or lowest value over the span of a single key.

+Inf and -Inf Ramps

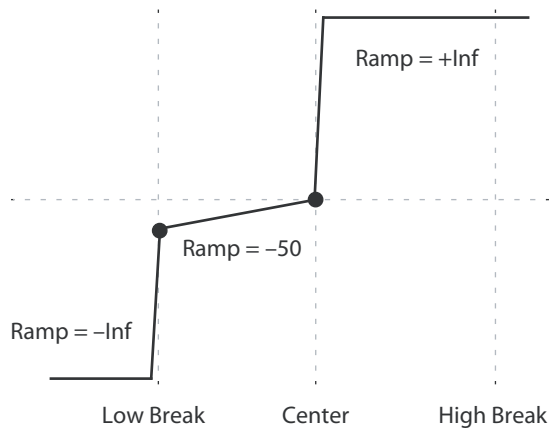

Note: If you set the Center-High ramp to +Inf or -Inf, the High-Top parameter will be grayed out. Similarly, if you set the Low-Center ramp to +Inf or -Inf, the Bottom-Low ramp will be grayed out.

Key Follow

To create the classic Key Follow effect, in which the filter frequency tracks the pitch of the keyboard:

1. Set the Filter Frequency to 30.
2. Set the Keyboard Track Intensity to +99.
3. Set the Bottom-Low and Low-Center ramps to -50.
4. Set the Center-High and High-Top ramps to +50.
5. Set the Center Key to C4.

The settings for the Low Break and High Break keys don't matter in this case.

Filter Keyboard Track is also an AMS source

You can use the keyboard tracking as an AMS source to modulate other parameters, just like the envelopes and LFOs. Simply select Filter Keytrack in the AMS list for the desired parameter.

3-2b: Filter EG

The Filter1 EG modulates the Filter A and B cutoff frequencies over time. You can control how strongly the EG will affect the filters in three different ways:

- Set an initial amount of EG modulation, using the Intensity to A and B parameters.
- Use velocity to scale the amount of the EG applied to the filter.
- Use any AMS source to scale the amount of the EG applied to the filter.

You can use all three of these at once, and the results are added together to produce the total EG effect.

To set up the EG itself, including attack and release times, levels, and so on, see “3-4: Filter1 EG,” on page 70.

Velocity to A

[–99...+99]

This lets you use velocity to scale the amount of the Filter EG applied to Filter A.

Velocity control of Filter EG

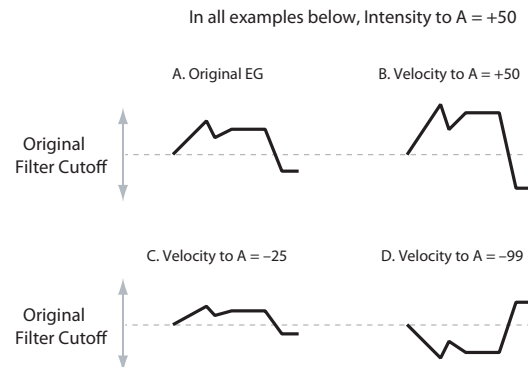

With **positive (+) values**, playing more strongly will increase the effect of the Filter EG, as shown in example **B** above.

With **negative (–) values**, playing more strongly will introduce the *opposite* effect of the Filter EG—like inverting the polarity of the envelope. You can use this in several different ways:

- You can set an initial positive amount with the Intensity to A/B parameters, and then reduce this amount with velocity. In this case, the final effect of the EG is simply diminished, and not actually inverted, as shown in example **C** above.
- You can also set the Velocity to A/B amounts so that they are greater than the initial amounts of Intensity to A/B. In this case, the EG will have a positive effect at low velocities, and an inverted effect at high velocities—as shown in example **D**.

Velocity to B

[–99...+99]

This lets you use velocity to scale the amount of the Filter EG applied to Filter B. For more information, see “Velocity to A,” above.

Intensity to A

[–99...+99]

This controls the initial effect of the Filter EG on Filter A's cutoff frequency, before any velocity or AMS modulation.

The Filter EG's shape can swing all the way from +99 to -99. Positive values increase the cutoff frequency, and negative values decrease the cutoff frequency. For instance, see the graphic “Velocity to A,” above. The EG shape in example **A** rises up at first, and then falls below 0 towards the end.

When Intensity to A is set to a **positive (+)** value, EG's effect will match its shape. When the EG rises above 0, the cutoff frequency will increase.

With **negative (–) values**, the effect will be in the opposite direction; when the EG rises above 0, the filter cutoff will *decrease*.

Intensity to B

[–99...+99]

This controls the initial effect of the Filter EG on Filter B's cutoff frequency, before any velocity or AMS modulation. For more information, see “Intensity to A,” above.

AMS (Filter EG) [List of AMS Sources]

This selects any AMS modulation source to scale the amount of the Filter EG applied to Filters A and B. The two filters share a single AMS source, with separate intensity settings. Otherwise, the AMS modulation will work in the same way as the **Velocity to A** parameter, described above.

For a list of AMS sources, see “Alternate Modulation Source (AMS) List” on page 903.

Intensity to A [-99...+99]

This controls the depth and direction of the EG AMS modulation for Filter A.

Intensity to B [-99...+99]

This controls the depth and direction of the EG AMS modulation for Filter B.

3-2c: Filter A/B Modulation

This section lets you assign any two AMS sources to control Filter A, and another two AMS sources to control Filter B. This modulation is added to the basic Filter A and B cutoff frequencies, as set on the Filter 1 page.

Filter A

AMS1 [List of AMS Sources]

This selects the first modulation source for controlling Filter A’s cutoff frequency. For a list of AMS sources, see “Alternate Modulation Source (AMS) List” on page 903.

Intensity (AMS1) [-99...+99]

This controls the depth and direction of AMS1.

AMS2 [List of AMS Sources]

This selects the second modulation source for controlling Filter A’s cutoff frequency. For a list of AMS sources, see “Alternate Modulation Source (AMS) List” on page 903.

Intensity (AMS2) [-99...+99]

This controls the depth and direction of AMS2.

Filter B

The parameters for Filter B are identical to those for Filter A. For more information, see the descriptions under Filter A, above.

✓ 3-2: Page Menu Commands

- Compare →p.112
- Write Program →p.112
- Exclusive Solo →p.113
- Copy Oscillator →p.119
- Swap Oscillator →p.119
- PAGE →p.126
- MODE →p.126

3-3: Filter1 LFO Mod.

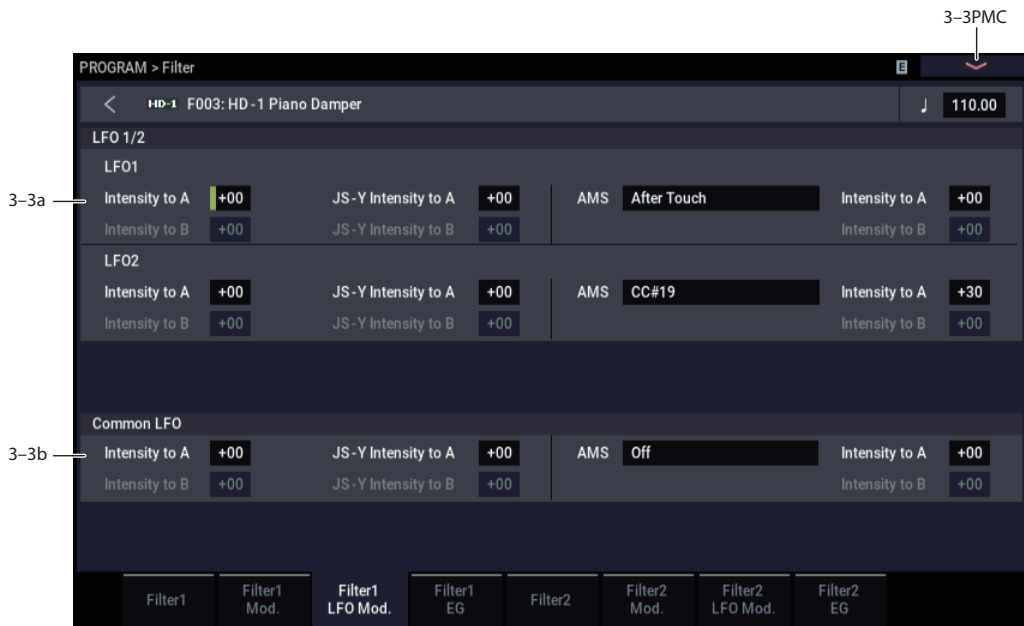

LFO1, LFO2, and the Common LFO can all modulate Filter A and B's cutoff frequencies. You can control the strength of each LFO's modulation in three different ways, independently for each filter:

- Set an initial amount of LFO modulation, using the Intensity to A and B parameters.
- Use JS-Y to scale the amount of the LFO.
- Use any AMS source to scale the amount the LFO.

You can use each of these methods for each of the three LFOs, and do so separately for both Filter A and Filter B. The results are added together to produce the total LFO effect.

3-3a: LFO 1/2

LFO1

Intensity to A (LFO1) [-99...+99]

This controls the initial effect of the LFO on Filter A's cutoff frequency, before any JS-Y or AMS modulation.

Negative (-) settings will invert the phase of the LFO. You can produce interesting effects by using the same LFO to modulate two different parameters (such as Filter A and Filter B), but with one set to a positive intensity, and the other set to a negative intensity.

LFO modulation of Filter Cutoff

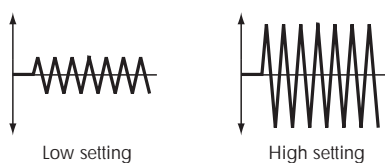

Intensity to B (LFO1) [-99...+99]

This controls the initial effect of the LFO on Filter B's cutoff frequency, before any JS-Y or AMS modulation.

JS-Y Intensity to A (LFO1) [-99...+99]

Moving the joystick "down" from the center detent position, towards yourself, produces the JS-Y controller. You can use this to scale the amount of the LFO applied to Filter A.

Negative (-) settings will invert the phase of the LFO. You can also use this to reduce the initial amount of the LFO, as set by **Intensity to A**, above. For example:

1. Set Intensity to A to +50.

The LFO will now have a fairly strong effect on the filter cutoff.

2. Set JS-Y Intensity to A to -50.

Now, if you move the joystick down, the effect of the LFO will fade away. When the joystick is all the way at the bottom of its range, the LFO will be completely canceled out.

JS-Y Intensity to B (LFO1) [-99...+99]

This lets you use JS-Y to scale the amount of the LFO applied to Filter B.

AMS (LFO1) [List of AMS Sources]

This selects any AMS modulation source to scale the amount of the LFO applied to Filters A and B. The two filters share a single AMS source, but with separate intensity settings.

For a list of AMS sources, see "Alternate Modulation Source (AMS) List" on page 903.

Intensity to A [-99...+99]

This controls the depth and direction of the LFO1 AMS modulation for Filter A.

For example, if AMS is set to **After Touch**, **positive** settings mean that aftertouch will increase the amount of LFO1 applied to Filter A.

Intensity to B [-99...+99]

This controls the depth and direction of the LFO1 AMS modulation for Filter B.

LFO 2

The parameters for LFO2 are identical to those for LFO1. For more information, see the descriptions under LFO1, above.

3-3b: Common LFO

The parameters for the Common LFO are identical to those for LFO1. For more information, see the descriptions under LFO1, above.

Note that while LFO1 and LFO2 are separate for each voice, the Common LFO is shared by all voices in the Program. This makes it useful when you want all of the voices to have an identical LFO effect.

3-3: Page Menu Commands

- Compare →p.112
- Write Program →p.112
- Exclusive Solo →p.113
- Copy Oscillator →p.119
- Swap Oscillator →p.119
- PAGE →p.126
- MODE →p.126

3-4: Filter1 EG AMSSource



The Filter EG, or Envelope Generator, lets you create complex, time-varying changes to the cutoff frequencies of Filters A and B. The parameters on this page control the shape of the EG. Among other things, you can:

- Create the basic EG shape by setting the levels and times of each segment.
- Control the curvature of each EG segment, for subtle control over the sound of the EG.
- Set up complex modulation of EG levels and times.
- Set up an AMS source, such as an LFO, to restart the EG.

To control how much effect the EG has on the filters, use the Filter EG parameters on the Filter– Filter1(2) Mod. page, as described under “3-2b: Filter EG,” on page 67.

Filter EG is also an AMS source

You can use the Filter EG as an AMS source to modulate other parameters, just like the keyboard tracking and LFOs. Simply select the Filter EG in the AMS list for the desired parameter.

3-4a: EG Reset

AMS (EG Reset) [List of AMS Sources]

This selects an AMS source to reset the EG to the start point. For instance, you can use a tempo-synced LFO to trigger the EG in a repeating rhythm. This reset is in addition to the initial note-on, which always causes the EG to start.

For a list of AMS sources, see “Alternate Modulation Source (AMS) List” on page 903.

Threshold [–99...+99]

This sets the AMS level which will trigger the EG reset. Among other things, you can use this to adjust the exact point in an LFO’s phase at which the EG will be reset, effectively controlling its “groove” against other rhythmic effects.

When the threshold is **positive**, the EG triggers when passing through the threshold moving upwards. When the threshold is **negative**, the EG triggers when passing through the threshold moving downwards.

Note: With some LFO shapes, and with faster LFO speeds, the LFO may not always reach the extreme values of +99 or -99. In this case, setting the **Threshold** to these values may

cause inconsistent behavior, or may mean that the EG doesn't reset at all. If this happens, reduce the **Threshold** until the EG triggers consistently.

3-4b: Envelope

Filter EG

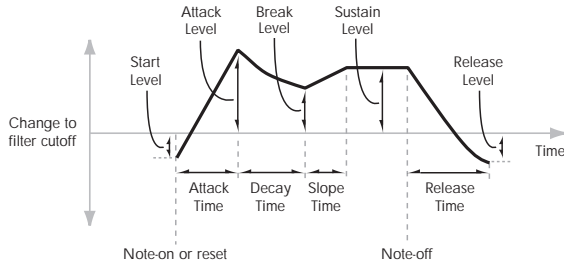

An envelope creates a modulation signal by moving from one level to another over a specified time, and then moving to another level over another period of time, and so on.

The parameters below let you set five levels, the amount of time it takes to go from each of the levels to the next, and the shape (from linear to curved) of each transition.

Level

Each of the five levels can be either positive or negative.

Positive levels will make the cutoff frequency (or other AMS destination) go up from its programmed value; **negative** levels will make it go down.

Start [-99...+99]
This sets the initial EG level, at note-on.

Attack [-99...+99]
This sets the level at the end of the Attack time.

Break [99...+99]
Break, short for Break Point, sets the level at the end of the Decay time.

Sustain [-99...+99]
This sets the level at the end of the Slope time. Once it reaches the Sustain level, the EG will stay there until note-off, unless it is reset via AMS.

Release [-99...+99]
This sets the level at the end of the Release time.

Time

Higher values mean longer times, as shown below:

| EG Value | Actual Time |
|----------|-------------|
| 00 | 0.667 ms |
| 10 | 10 ms |
| 20 | 44 ms |
| 30 | 104 ms |
| 40 | 224 ms |
| 50 | 464 ms |
| 60 | 944 ms |
| 70 | 1.8 seconds |
| 80 | 3.8 seconds |

| EG Value | Actual Time |
|----------|--------------|
| 90 | 10.9 seconds |
| 99 | 87.3 seconds |

Attack [00...99]
This sets how long the EG takes to move from the Start level to the Attack level.

The minimum attack time is 2/3 of a millisecond—as fast as the most punchy of classic analog synths.

For the fastest possible attack time, you can set the Start level to +99; in this case, the EG will start instantaneously at its maximum value.

Decay [00...99]
This sets the time it takes to move from the Attack level to the Break level.

Slope [00...99]
This sets how long the EG takes to move from the Break level to the Sustain level. Once it reaches the Sustain level, the EG will stay there until note-off (unless it is reset via AMS).

Release [00...99]
This sets how long it takes the EG to move from the Sustain level to the Release level.

Curve

For the sake of simplicity, most of the diagrams in this manual show envelopes as being made out of straight lines. In actuality, though, envelopes are more likely to be made out of curves.

In other words, each segment's level will change quickly at first, and then slow down as it approaches the next point. This tends to sound better than straight, linear segments.

Classic analog synth envelopes made these curved shapes naturally. The NAUTILUS goes a step further than vintage synths, however, and lets you control the amount of curvature separately for each of the four envelope segments.

Filter EG Curve

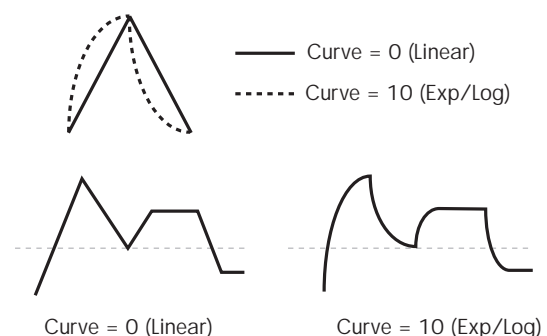

When you change the curvature, the EG times remain the same. However, greater curvature will tend to *sound* faster, because the value changes more quickly at the beginning.

Different curve settings for up and down

You may find that different amounts of curvature are suitable for segments which go up and segments which go down.

For instance, a curve of 3 is a good default setting for upward segments, such as Attack. On the other hand, a curve of 6 or more is good for downward segments, such as Decay and Release.

Attack [0 (Linear), 1...9, 10 (Exp/Log)]

This sets the curvature of the Attack segment - the transition from the Start level to the Attack level.

Decay [0 (Linear), 1...9, 10 (Exp/Log)]

This sets the curvature of the Decay segment - the transition from the Attack level to the Break level.

Slope [0 (Linear), 1...9, 10 (Exp/Log)]

This sets the curvature of the Slope segment - the transition from the Break level to the Sustain level.

Release [0 (Linear), 1...9, 10 (Exp/Log)]

This sets the curvature of the Release segment - the transition from the Sustain level to the Release level.

3-4c: Level Modulation

These settings let you use any AMS source to control the Level parameters of the EG. The Start, Attack, and Break levels share a single AMS source, but can each have different modulation intensities.

By using different settings for each of the three levels, you can cause both subtle and dramatic changes to the EG shape, as shown below.

Filter EG Level Modulation

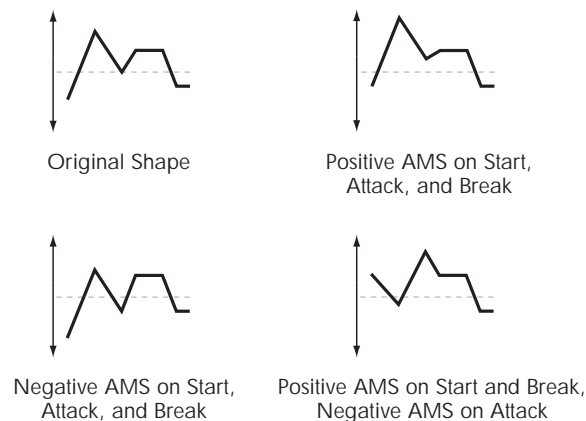

Once an EG segment begins, it can't be modulated

Once the EG has started a segment between two points, that segment can no longer be modulated. This includes both the time of the segment, and the level reached at the end of the segment.

For instance, if the EG is in the middle of the Decay time, you can no longer modulate either the Decay time or the Break level.

As another example, let's say that you've assigned the Common LFO to modulate Break Level. The LFO may be moving all the time, but the Break Level is only affected by the LFO's value at the instant that the Decay segment starts. After that, the level is fixed.

Finally, this also means that modulating the Start level, Attack level, or Attack time will not affect notes that are already sounding, unless the EG is then reset via AMS.

AMS [List of AMS Sources]

Selects an AMS source to control the EG's Level parameters.

For a list of AMS sources, see "Alternate Modulation Source (AMS) List" on page 903.

Start [-99...+99]

This controls the depth and direction of the AMS modulation for the Start level.

For example, if you set the AMS source to Velocity and set Start to +99, the Start level will increase as you play harder. If you instead set Start to -99, the Start level will decrease as you play harder.

Attack [-99...+99]

This controls the depth and direction of the AMS modulation for the Attack level.

Break [-99...+99]

This controls the depth and direction of the AMS modulation for the Break level.

3-4d: Time Modulation

These settings let you use three different AMS sources to control the Time parameters of the EG. For each of the three AMS sources, the Attack, Decay, Slope, and Release times each have their own modulation intensities.

Filter EG Time Modulation

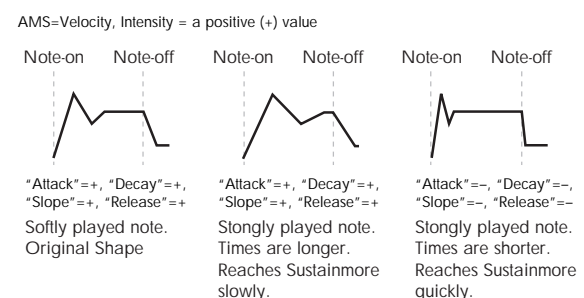

AMS1 [List of AMS Sources]

Selects the first AMS source to control the EG's Time parameters. Velocity and Keyboard Track can both be useful here, for instance.

For a list of AMS sources, see "Alternate Modulation Source (AMS) List" on page 903.

Attack [-99...+99]

This controls the depth and direction of the AMS modulation for the Attack time.

For example, if you set the AMS source to Velocity and set Attack to +99, the Attack time will get much longer at higher velocities. If you instead set Attack to -99, the Attack time will get much shorter at higher velocities.

When the AMS source is at its maximum value—for instance, when Velocity is at 127—a setting of +8 will make the Attack time almost twice as long, and a setting of –8 will cut the Attack time almost in half.

Decay [–99...+99]

This controls the depth and direction of the AMS modulation for the Decay time.

Slope [–99...+99]

This controls the depth and direction of the AMS modulation for the Slope time.

Release [–99...+99]

This controls the depth and direction of the AMS modulation for the Release time.

AMS2 and AMS3

These select the second and third AMS sources, respectively, for controlling the EG’s Time parameters. Each has its own intensities for Attack, Decay, Slope, and Release. The parameters of both AMS2 and AMS 3 are identical to those of AMS1, above.

✓ **3–4: Page Menu Commands**

- Compare →p.112
- Write Program →p.112
- Exclusive Solo →p.113
- Copy Oscillator →p.119
- Swap Oscillator →p.119
- Sync Both EGs →p.121
- PAGE →p.126
- MODE →p.126

3–5: Filter2

This page controls Oscillator 2’s basic filter settings. It is available only when the **Oscillator Mode** is set to **Double**; if not, the page will be grayed out.

The parameters are identical to those for Oscillator 1, as described under “3–1: Filter1,” on page 62.

3–6: Filter2 Mod.

This page controls Oscillator 2’s filter modulation. It is available only when the **Oscillator Mode** is set to **Double**; if not, the page will be grayed out.

The parameters are identical to those for Oscillator 1, as described under “3–2: Filter1 Mod.,” on page 65.

3–7: Filter2 LFO Mod.

This page controls Oscillator 2’s LFO filter modulation. It is available only when the **Oscillator Mode** is set to **Double**; if not, the page will be grayed out.

The parameters are identical to those for Oscillator 1, as described under “3–3: Filter1 LFO Mod.,” on page 69.

3–8: Filter2 EG AMSource

This page controls Oscillator 2’s Filter EG. It is available only when the **Oscillator Mode** is set to **Double**; if not, the page will be grayed out.

The parameters are identical to those for Oscillator 1, as described under “3–4: Filter1 EG,” on page 70.

PROGRAM > Amp/EQ

Oscillators 1 and 2 have separate controls for volume (also called “amplitude,” or “amp” for short), pan, and Drive, as well as dedicated amp envelopes and keyboard tracking generators. Additionally, both Oscillators share a three-band EQ.

These pages let you control all of these related parameters. Among other things, you can:

- Set up the Driver circuit, which adds saturation and bass boost to the timbre.

- Set the pan position and pan modulation.
- Control amp level and modulation, including keyboard tracking, the amp envelope, LFO modulation, and AMS control.
- Set up the three-band Track EQ.

Note that when the **Oscillator Mode** is set to **Single**, only Oscillator 1’s amp, pan, and drive parameters are active; the pages for Oscillator 2 will be grayed out.

4-1: Amp1/Driver1



This page controls the basic settings for the Amp/EQ section. Here, you can:

- Set up the Driver circuit.
- Set the initial volume level.
- Control the pan position and pan modulation.

4-1a: Driver

The Driver adds saturation and overdrive to the sound, for everything from subtle fattening to drastic distortion. Unlike an overdrive effect, the Driver processes each voice individually, so the timbre stays the same regardless of how many voices are being played.

The two main parameters, Drive and Low Boost, work together to create the overall Driver effect. Drive contributes edge and bite, and Low Boost provides the body as well as boosting the bass.

Bypass [Off, On]

When Bypass is On, the Driver is completely removed from the signal path.

Drive [00...99]

This controls the amount of edge and bite in the timbre. Low settings will produce mild saturation, and higher settings create more obvious distortion.

Often, it’s useful to increase the Low Boost along with the Drive.

Note: Even when the Drive amount is set to 0, the Driver circuit still affects the timbre. If your goal is a completely pristine sound, use the Bypass control instead.

AMS (Drive) [List of AMS Sources]

This selects an AMS modulation source to control the Drive amount. For a list of AMS sources, see “Alternate Modulation Source (AMS) List” on page 903.

Intensity [-99...+99]

This controls the depth and direction of the AMS modulation for Drive.

Low Boost [00...99]

This low-frequency EQ controls the body character of the sound. The specific EQ frequencies affected will change with the Drive setting.

Higher amounts increase the bass boost, and will also intensify the effect of the Drive parameter.

AMS (Low Boost) [List of AMS Sources]

This selects an AMS modulation source to control the Low Boost amount. For a list of AMS sources, see “Alternate Modulation Source (AMS) List” on page 903.

Intensity [-99...+99]

This controls the depth and direction of the AMS modulation for Low Boost.

4-1b: Amp Level**Amp Level** [000...127]

This controls the basic volume level of Oscillator 1, before keyboard tracking, velocity, and other modulation.

MIDI and volume

MIDI You can control the Program's overall volume via MIDI using both Volume (CC#7) and Expression (CC#11). When used one at a time, the two controllers work in exactly the same way: a MIDI value of 127 is equal to the Amp Level setting, and lower values reduce the volume.

If both CC#7 and CC#11 are used simultaneously, the one with the *lower* value determines the maximum volume, and the one with the higher value scales down from that maximum.

This is controlled on the global MIDI channel (GLOBAL 1-1a).

4-1c: Pan**Pan** [Random, L001...C064...R127]

This controls the stereo pan of Oscillator 1. A setting of **L001** places the sound at the far left, **C064** in the center, and **R127** to the far right.

If the Oscillator is playing a stereo Multisample, **Pan** steers the stereo image while maintaining the relative volumes of the left and right samples. For instance, as you move **Pan** to the right of center, the left sample will start to move to the right side, until at **R127** both the left and right samples sound entirely in the right channel.

When this is set to **Random**, the pan position will be different for each note-on.

MIDI You can also control pan via MIDI Pan (CC#10). A CC#10 value of 0 or 1 places the sound at the far left, 64 places the sound at the location specified by the **Pan** parameter, and 127 places the sound at the far right. This is controlled on the global MIDI channel (GLOBAL 1-1a).

Note: You can select Random pan only from the on-screen UI, and not from MIDI.

AMS (Pan) [List of AMS Sources]

This selects an AMS source to modulate Pan. For a list of AMS sources, see "Alternate Modulation Source (AMS) List" on page 903.

Intensity [-99...+99]

This controls the depth and direction of the AMS modulation for Pan.

For example, if **Pan** is set to C064 and **AMS** is set to Note Number, **positive (+)** intensities will cause the sound to move toward the right as you play higher than C4, and toward the left as you play lower than C4.

Negative (-) intensities will have the opposite effect.

Use DKit Setting [Off, On]

This option is available only when the **Oscillator Mode** is set to **Drums** or **Double Drums**.

Unlike standard Programs, Drum Kits can have a different pan setting for every note. This parameter lets you choose whether to use the Drum Kit pan settings, or to use the Program's pan setting instead.

On (checked): The Program will use the Drum Kit's per-note pan settings; pan AMS will still apply. This is the default setting.

Off (unchecked): The Program will ignore the Drum Kit's settings, and use the Program pan instead.

All keys of the drum kit will use the **Pan** (4-1c) setting.

✓ 4-1: Page Menu Commands

- Compare →p.112
- Write Program →p.112
- Exclusive Solo →p.113
- Copy Oscillator →p.119
- Swap Oscillator →p.119
- PAGE →p.126
- MODE →p.126

4-2: Amp1 Mod.

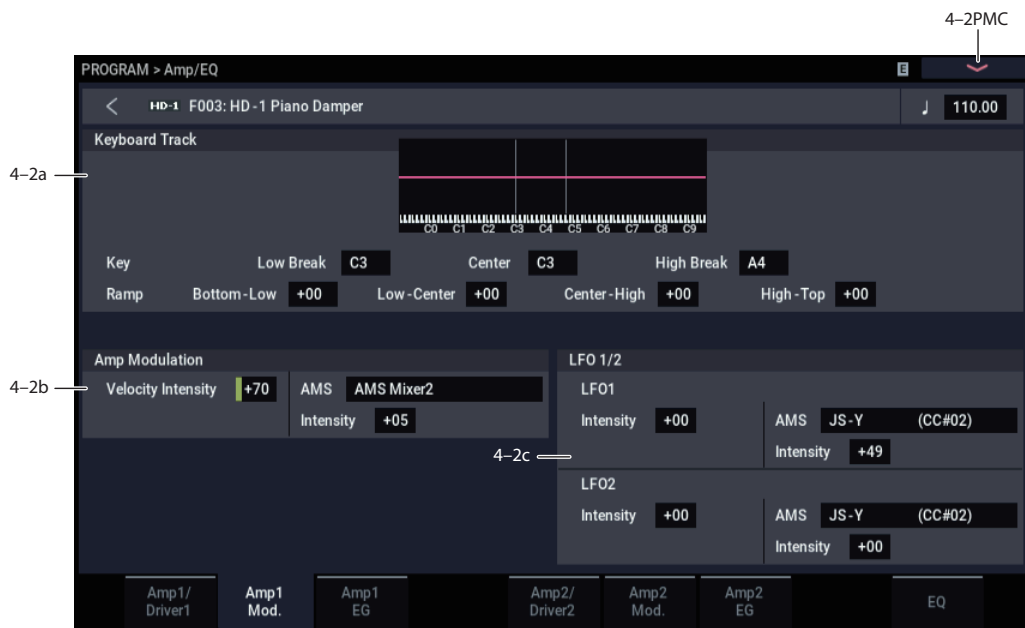

This page contains the settings for Oscillator 1's Amp level modulation. Among other things, you can:

- Set up complex keyboard tracking shapes to control the Amp level.
- Assign AMS modulation for the Amp level.
- Control the effect of the LFOs on the Amp level.

The total effects of the modulation can increase the volume to a maximum of two times louder than the Amp Level setting.

4-2a: Keyboard Track AMSSource

Keyboard tracking lets you vary the volume as you play up and down the keyboard. Usually, some amount of key tracking is necessary in order to make the volume consistent across the entire range.

NAUTILUS's keyboard tracking can be fairly complex, if desired. You can create different rates of change over up to four different parts of the keyboard. For instance, you can:

- Make the volume increase very quickly over the middle of the keyboard, and then increase more slowly—or not at all—in the higher octaves.
- Make the volume increase as you play *lower* on the keyboard.
- Create abrupt changes at certain keys, for split-like effects.

How it works: Keys and Ramps

The keyboard tracking works by creating four ramps, or slopes, between five keys on the keyboard. The bottom and top keys are fixed at the bottom and top of the MIDI range, respectively. You can set the other three keys—named Low Break, Center, and High Break—to be anywhere in between.

The four Ramp values control the rate of change between each pair of keys. For instance, if the Low-Center Ramp is set to 0, the value will stay the same between the Low Break key and the Center key.

You can think of the resulting shape as being like two folding doors attached to a hinge in the center. At the Center key (the main hinge), the keyboard tracking has no effect. The two folding doors swing out from this center point to create changes in the higher and lower ranges of the keyboard.

Key

Low Break [C-1...G9]

This sets the breakpoint note between the two lower ramps - the “hinge” of the lower door.

Center [C-1...G9]

This sets the center of the keyboard tracking - the main “hinge.” At this key, the keyboard tracking has no effect on the volume, or on any AMS destinations.

High Break [C-1...G9]

This sets the breakpoint note between the two higher ramps - the “hinge” of the upper door.

Entering notes from the keyboard

You can enter note numbers directly by playing them on the keyboard. To do so:

1. Select one of the Key parameters.
2. Hold down the ENTER key.
3. While holding ENTER, play a note on the keyboard.

Ramp

Positive ramp values mean that the keyboard tracking output increases as you play farther from the Center Key; negative ramp values mean that it decreases.

Because of this, the meanings of positive and negative ramp settings will change depending on whether the ramp is to the left or right of the Center Key.

Bottom-Low and Low-Center: negative ramps make the keyboard tracking's output go down as you play lower on the keyboard, and positive ramps make the output go higher.

Center-High and High-Top: negative ramps make the keyboard tracking's output go down as you play *higher* on the keyboard, and positive ramps make the output go up.

Differences from other Keyboard Tracks

There are several differences between the Amp keyboard tracking and the Filter and Common keyboard tracking. For example, the results of the Ramp values are different. As shown in the graphic "Amp Keyboard Tracking," below, negative slopes are more steep than positive slopes.

Also, the amp does not have separate control of Intensity. Instead, Intensity is always fixed at the maximum amount, allowing keyboard tracking to change the volume from complete silence to twice as loud as the programmed level.

Bottom-Low [-Inf, -99...+99, +Inf]

This sets the slope between the bottom of the MIDI note range and the Low Break key. For normal key track, use negative values.

Low-Center [-Inf, -99...+99, +Inf]

This sets the slope between the Low Break and Center keys. For normal key track, use negative values.

Center-High [-Inf, -99...+99, +Inf]

This sets the slope between the Center and High Break keys. For normal key track, use positive values.

High-Top [-Inf, -99...+99, +Inf]

This sets the slope between the High Break key and the top of the MIDI note range. For normal key track, use positive values.

| Ramp | Change in level |
|------|--------------------------|
| -Inf | Silent in one half-step |
| -99 | Silent in one whole-step |
| -95 | Silent in one octave |
| -48 | Silent in two octaves |
| -25 | Silent in four octaves |
| 00 | no change |
| +25 | x2 in four octaves |
| +50 | x2 in two octaves |
| +99 | x2 in one octave |
| +Inf | x2 in one half-step |

+Inf and -Inf ramps

+Inf and -Inf are special settings which create abrupt changes for split-like effects. When a ramp is set to +Inf or -Inf, the keyboard tracking will go to its extreme highest or lowest value over the span of a single key.

When a ramp is set to +Inf, the keyboard tracking will go to its highest value (double the programmed volume) over a single half-step.

Similarly, when a ramp is set to -Inf, the keyboard tracking will go to its lowest value (complete silence) over a single half-step.

Note: If you set the Center-High ramp to +Inf or -Inf, the High-Top parameter will be grayed out. Similarly, if you set the Low-Center ramp to +Inf or -Inf, the Bottom-Low ramp will be grayed out.

Amp Keytrack is also an AMS source

You can use the keyboard tracking as an AMS source to modulate other parameters, just like the envelopes and LFOs. Simply select Amp Keytrack in the AMS list for the desired parameter.

Amp Keyboard Tracking

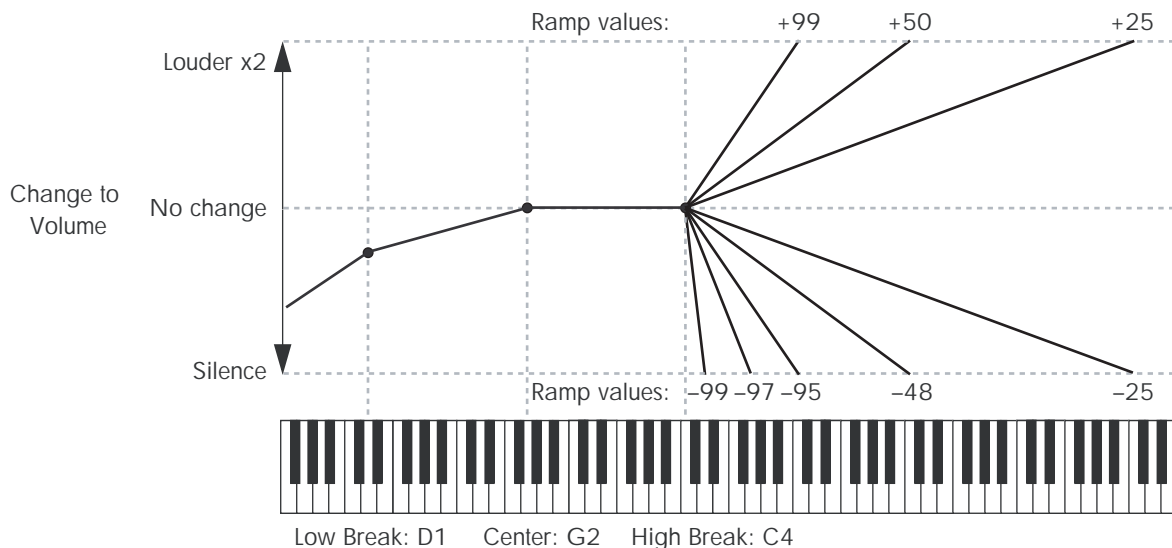

4-2b: Amp Modulation

You can modulate the Amp level by both velocity and an AMS source.

This modulation scales the basic Amp level and Amp EG level parameters. The resulting volume is determined by multiplying the volume changes of the amp EG by other values such as AMS. If these original levels are low, the maximum volume available with modulation will also be reduced.

Velocity Intensity [-99...+99]

With **positive (+)** values, the volume will increase as you play harder.

With **negative (-)** values, the volume will decrease as you play harder.

Velocity modulation of Amp level, with Amp EG

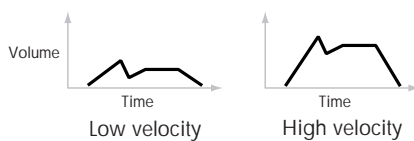

AMS [List of AMS Sources]

This selects any AMS modulation source to control the Amp level. For a list of AMS sources, see “Alternate Modulation Source (AMS) List” on page 903.

Intensity [-99...+99]

This controls the depth and direction of the modulation.

For example, if **AMS** is set to After Touch, **positive (+)** values of this parameter will make the volume increase when you press down on the keyboard.

Note that if the other modulation settings have already raised the volume to its maximum level (double the Amp Level and Amp EG level settings), the volume cannot be increased any further.

With **negative (-)** values of this parameter, the volume will decrease when pressure is applied to the keyboard.

4-2c: LFO 1/2

You can modulate the Amp level with both LFO1 and LFO2.

LFO1

Intensity (LFO1) [-99...+99]

This controls the depth and direction of LFO1’s effect on the oscillator’s volume.

Negative (-) values will invert the LFO waveform.

AMS (LFO1) [List of AMS Sources]

This selects an AMS modulation source to scale the amount of the LFO1 applied to the Amp level.

For a list of AMS sources, see “Alternate Modulation Source (AMS) List” on page 903.

Intensity [-99...+99]

This controls the depth and direction of the LFO1 AMS modulation for the Amp level.

For example, if **AMS** is set to After Touch, **positive** settings mean that aftertouch will increase the amount of LFO1 applied to the Amp level.

LFO2

The parameters for LFO2 are identical to those for LFO1. For more information, see the descriptions under LFO1, above.

✓ 4-2: Page Menu Commands

- Compare →p.112
- Write Program →p.112
- Exclusive Solo →p.113
- Copy Oscillator →p.119
- Swap Oscillator →p.119
- PAGE →p.126
- MODE →p.126

4-3: Amp1 EG AMS_{Source}

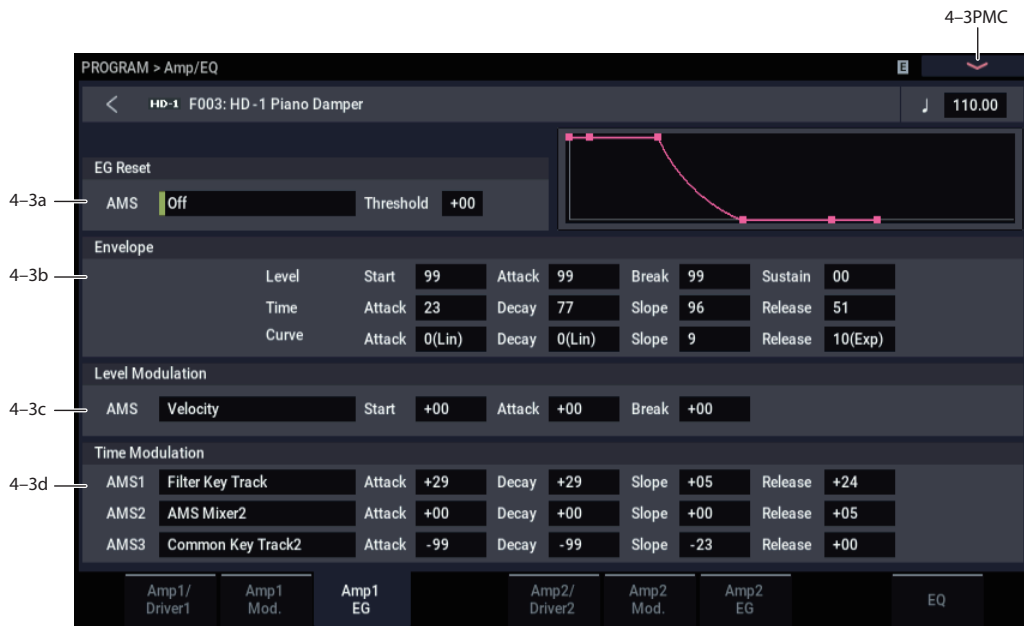

These parameters let you create time-varying changes in the volume of oscillator 1.

4-3a: EG Reset

AMS (EG Reset) [List of AMS Sources]

This selects an AMS source to reset the EG to the start point. For instance, you can use a tempo-synced LFO to trigger the EG in a repeating rhythm. This reset is in addition to the initial note-on, which always causes the EG to start.

Note: Once the Amp EG is in its Release segment, it cannot be reset. (Otherwise, the sound might keep playing forever!)

For a list of AMS sources, see “Alternate Modulation Source (AMS) List” on page 903.

Threshold [−99...+99]

This sets the AMS level which will trigger the EG reset. Among other things, you can use this to adjust the exact point in an LFO’s phase at which the EG will be reset, effectively controlling its “groove” against other rhythmic effects.

When the threshold is **positive**, the EG triggers when passing through the threshold moving upwards. When the threshold is **negative**, the EG triggers when passing through the threshold moving downwards.

Note: With some LFO shapes, and with faster LFO speeds, the LFO may not always reach the extreme values of +99 or -99. In this case, setting the **Threshold** to these values may cause inconsistent behavior, or may mean that the EG doesn’t reset at all. If this happens, reduce the **Threshold** until the EG triggers consistently.

4-3b: Envelope

These parameters specify how the amp 1 EG will change over time.

Amp EG

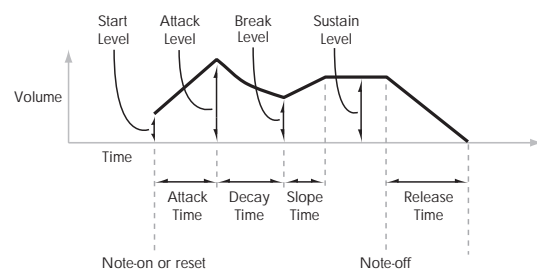

Level

Start [00...99]

This sets the initial volume level at note-on.

Attack [00...99]

This sets the level at the end of the Attack time.

Break [00...99]

Break, short for Break Point, sets the level at the end of the Decay time.

Sustain [00...99]

This sets the level at the end of the Slope time. Once it reaches the Sustain level, the EG will stay there until note-off (unless it is reset via AMS).

Time

Higher values mean longer times, as shown below.

| EG Value | Actual Time |
|----------|--------------|
| 00 | 0.667 ms |
| 10 | 10 ms |
| 20 | 44 ms |
| 30 | 104 ms |
| 40 | 224 ms |
| 50 | 464 ms |
| 60 | 944 ms |
| 70 | 1.8 seconds |
| 80 | 3.8 seconds |
| 90 | 10.9 seconds |
| 99 | 87.3 seconds |

Attack [00...99]

This sets how long the EG takes to move from the Start level to the Attack level.

The minimum attack time is 2/3 of a millisecond—as fast as the most punchy of classic analog synths.

For the fastest possible attack time, you can set the Start level to +99; in this case, the EG will start instantaneously at its maximum value.

Decay [00...99]

This sets the time it takes to move from the Attack level to the Break level.

Slope [00...99]

This sets how long the EG takes to move from the Break level to the Sustain level. Once it reaches the Sustain level, the EG will stay there until note-off (unless it is reset via AMS).

Release [00...99]

This sets how long it takes the EG to move from the Sustain level to silence.

Curve

For the sake of simplicity, most of the diagrams in this manual show envelopes as being made out of straight lines. In actuality, though, envelopes are more likely to be made out of curves.

In other words, each segment’s level will change quickly at first, and then slow down as it approaches the next point. This tends to sound better than straight, linear segments.

Classic analog synth envelopes made these curved shapes naturally. The NAUTILUS goes a step further than vintage synths, however, and lets you control the amount of curvature separately for each of the four envelope segments.

When you change the curvature, the EG times remain the same. However, greater curvature will tend to *sound* faster, because the value changes more quickly at the beginning.

Amp EG Curve

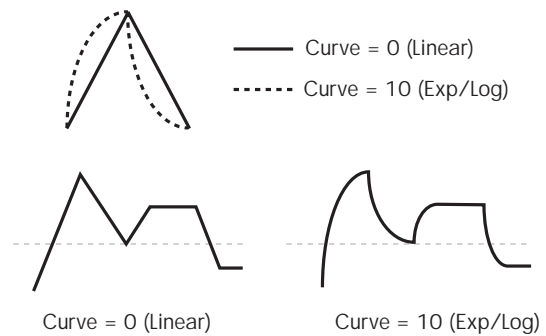

Different curve settings for up and down

You may find that different amounts of curvature are suitable for segments which go up and segments which go down.

For instance, a curve of 3 is a good default setting for upward segments, such as Attack. On the other hand, a curve of 6 or more is good for downward segments, such as Decay and Release.

Attack [0 (Linear), 1...9, 10 (Exp/Log)]

This sets the curvature of the Attack segment - the transition from the Start level to the Attack level.

Decay [0 (Linear), 1...9, 10 (Exp/Log)]

This sets the curvature of the Decay segment - the transition from the Attack level to the Break level.

Slope [0 (Linear), 1...9, 10 (Exp/Log)]

This sets the curvature of the Slope segment - the transition from the Break level to the Sustain level.

Release [0 (Linear), 1...9, 10 (Exp/Log)]

This sets the curvature of the Release segment - the transition from the Sustain level to the Release level.

4-3c: Level Modulation

These settings let you use any AMS source to control the Level parameters of the EG. The Start, Attack, and Break levels share a single AMS source, but can each have different modulation intensities.

By using different settings for each of the three levels, you can cause both subtle and dramatic changes to the EG shape, as shown below.

Amp EG Level Modulation

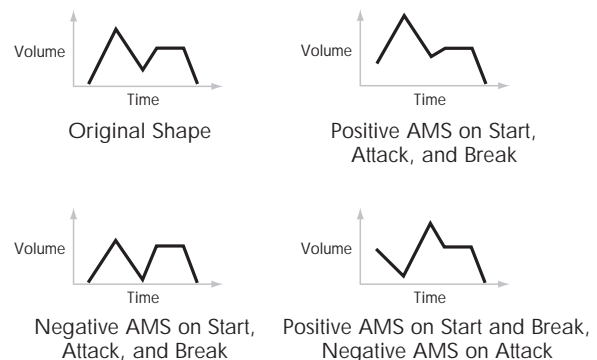

Once an EG segment begins, it can't be modulated

Once the EG has started a segment between two points, that segment can no longer be modulated. This includes both the time of the segment, and the level reached at the end of the segment.

For more information, see "Once an EG segment begins, it can't be modulated" on page 72.

AMS [List of AMS Sources]

This selects an AMS source to control the EG's Level parameters.

For a list of AMS sources, see "Alternate Modulation Source (AMS) List" on page 903.

Start [-99...+99]

This controls the depth and direction of the AMS modulation for the Start level.

For example, if you set the AMS source to Velocity and set Start to +99, the Start level will increase as you play harder. If you instead set Start to -99, the Start level will decrease as you play harder.

Attack [-99...+99]

This controls the depth and direction of the AMS modulation for the Attack level.

Break [-99...+99]

This controls the depth and direction of the AMS modulation for the Break level.

4-3d: Time Modulation

These settings let you use three different AMS sources to control the Time parameters of the EG. For each of the three AMS sources, the Attack, Decay, Slope, and Release times each have their own modulation intensities.

Amp EG Time Modulation

AMS=Velocity, Intensity = a positive (+) value

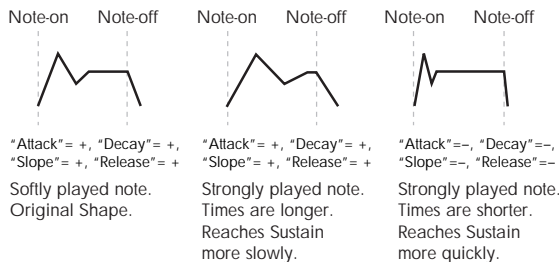

AMS1 [List of AMS Sources]

Selects the first AMS source to control the EG's Time parameters. Velocity and Keyboard Track can both be useful here, for instance.

For a list of AMS sources, see "Alternate Modulation Source (AMS) List" on page 903.

Attack [-99...+99]

This controls the depth and direction of the AMS modulation for the Attack time.

For example, if you set the AMS source to Velocity and set Attack to +99, the Attack time will get much longer at higher velocities. If you instead set Attack to -99, the Attack time will get much shorter at higher velocities.

When the AMS source is at its maximum value—for instance, when Velocity is at 127—a setting of +8 will make the segment time almost twice as long, and a setting of -8 will cut the segment time almost in half.

Decay [-99...+99]

This controls the depth and direction of the AMS modulation for the Decay time.

Slope [-99...+99]

This controls the depth and direction of the AMS modulation for the Slope time.

Release [-99...+99]

This controls the depth and direction of the AMS modulation for the Release time.

AMS2 and AMS3

These select the second and third AMS sources, respectively, for controlling the EG's Time parameters. Each has its own intensities for Attack, Decay, Slope, and Release. The parameters of both AMS2 and AMS 3 are identical to those of AMS1, above.

✓ 4-3: Page Menu Commands

- Compare →p.112
- Write Program →p.112
- Exclusive Solo →p.113
- Copy Oscillator →p.119
- Swap Oscillator →p.119
- Sync Both EGs →p.121
- PAGE →p.126
- MODE →p.126

4-5: Amp2/Driver2

This page controls Oscillator 2's basic level, pan, and driver settings. It is available only when the **Oscillator Mode** is set to **Double**; if not, the page will be grayed out.

The parameters are identical to those for Oscillator 1, as described under "4-1: Amp1/Driver1," on page 74.

4-6: Amp2 Mod.

This page controls Oscillator 2's amp modulation. It is available only when the **Oscillator Mode** is set to **Double**; if not, the page will be grayed out.

The parameters are identical to those for Oscillator 1, as described under "4-2: Amp1 Mod.," on page 76.

4-7: Amp2 EG AMSource

This page controls Oscillator 2's amp EG. It is available only when the **Oscillator Mode** is set to **Double**; if not, the page will be grayed out.

The parameters are identical to those for Oscillator 1, as described under "4-3: Amp1 EG," on page 79.

4-9: EQ



This three-band EQ, with sweepable mid, is shared by both of the Program's oscillators. The Drum Track has its own EQ: for more information, see "EQ" on page 17.

In Combis and Sequences, each timbre and track has its own individual EQ. You can import the Program's EQ settings into Tracks and Timbres by using the Combi and Sequence "Auto-Load Program EQ" options.

4-9a: 3 Band Parametric EQ

Bypass [On, Off]

When Bypass is checked, all of the EQ will be disabled, including the Input Trim.

Bypass can be convenient for comparing the results of the EQ with the original signal.

Input Trim [00...99]

This controls the volume level going into the EQ.

High settings of the Low, Mid, and High Gain controls can cause substantial increases in the overall level. You can compensate for this by turning down the input trim.

Low Gain [-18.0...+18.0dB]

This controls the gain of the 80Hz Low Shelf EQ, in increments of 0.5dB.

Mid Frequency [100Hz...10.00kHz]

This sets the center frequency for the Mid sweep EQ.

Mid Gain [-18.0...+18.0dB]

This controls the gain of the Mid Sweep EQ, in increments of 0.5dB.

High Gain [-18.0...+18.0dB]

This controls the gain of the 10kHz High Shelf EQ, in increments of 0.5dB.

✓ 4-9: Page Menu Commands

- Compare →p.112
- Write Program →p.112
- Exclusive Solo →p.113
- Copy Oscillator →p.119
- Swap Oscillator →p.119
- PAGE →p.126
- MODE →p.126

PROGRAM > LFO

Each of the Oscillators has two LFOs, which you can use to modulate the filter, amp, pitch, and many other parameters.

The two Oscillators also share a single Common LFO, similar to the global LFO on some vintage analog synths.

These pages let you set up all of the parameters for all five LFOs.

5-1: OSC1 LFO1 AMS



This page has all of the controls for the first LFO of Oscillator 1. For instance, you can:

- Select the LFO's basic waveform, and modify it with the Shape parameter.
- Control the LFO's frequency, and assign AMS controllers to modulate the frequency.
- Use the Key Sync parameter to choose whether the LFO runs separately for each voice, or is synchronized across all of the voices
- Use the Fade and Delay parameters to control how long the LFO waits to start after note-on, and whether it starts abruptly or fades in slowly.
- Set the LFO to sync to MIDI tempo.

5-1a: OSC 1 LFO 1

Waveform [Triangle...Random6 (Continuous)]

This selects the basic LFO waveform, as shown in the graphic below.

Most of the waveforms should be self-explanatory, but a few will benefit from more details:

Guitar is intended for guitar vibrato, and its shape is specifically tuned for this purpose. The waveform is positive-only, so that when used for pitch, it will only bend up, and not down.

Random1 (S/H) generates traditional sample and hold waveforms, in which the level changes randomly at fixed intervals of time.

Random2 (S/H) randomizes both the levels and the timing.

Random3 (S/H) generates a pulse wave with random timing. It's the opposite of traditional sample and hold; the timing varies, but the levels don't.

LFO Waveforms



Random4–6 (Continuous) are smoothed versions of Random 1–3, with ramps instead of steps. You can use them to create more gentle random variations.

Start Phase **[–180...+180, Random]**

This controls the phase of the waveform at the start of the note, in steps of 5 degrees.

If **Key Sync** is Off, the Start Phase will apply only to the first note of the phrase.

Shape **[–99...+99]**

Shape adds curvature to the basic waveform. As you can see in the graphic below, this can make the waveforms either more rounded or more extreme. It can also be useful to emphasize certain value ranges, and de-emphasize others.

For example, let’s say that you are using a triangle LFO to modulate filter cutoff. If Shape emphasizes the high value range, the filter will spend more time at the higher frequencies. If it emphasizes the low range, the filter will spend more time at the lower frequencies.

LFO Shape

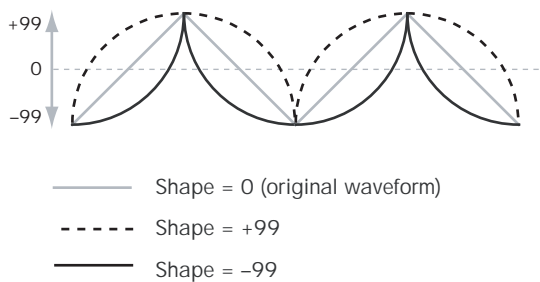

Note: Shape does **not** affect the Square and Random 3 waveforms, since their values are always either +99 or –99. When these are selected, Shape is grayed out.

AMS (Shape) **[List of AMS Sources]**

This selects a modulation source for controlling the LFO’s Shape. Modulating the shape can dramatically alter the effect of the LFO—try it out!

For a list of AMS sources, see “Alternate Modulation Source (AMS) List” on page 903.

Intensity **[–99...+99]**

This controls the depth and direction of the Shape modulation.

Frequency **[00...99]**

This controls the speed of the LFO, before any modulation. Higher values mean faster speeds, as shown in the table below.

By using AMS modulation, you can also get speeds much faster and much slower than are available through this basic setting.

| Frequency Value | Frequency in Hz |
|-----------------|-----------------|
| 00 | 0.014 Hz |
| 10 | 0.112 Hz |
| 20 | 0.422 Hz |
| 30 | 0.979 Hz |
| 40 | 1.79 Hz |
| 50 | 2.84 Hz |

| Frequency Value | Frequency in Hz |
|-----------------|-----------------|
| 60 | 4.14 Hz |
| 70 | 5.69 Hz |
| 80 | 7.49 Hz |
| 90 | 9.53 Hz |
| 99 | 26.25 Hz |
| 99 + Fine 99 | 32 Hz |

Frequency Fine **[00...99]**

This allows you to control the LFO frequency with greater precision, giving you 98 additional steps for each step of the main Frequency parameter.

When this is set to 00, the LFO speed is as set by the Frequency parameter.

When this is set to 99, it’s the same as increasing the main Frequency value by 1.

Stop **[Off, On]**

On (checked): When Stop is **On**, the LFO does not advance normally, and the Frequency parameters are ignored. Instead, the LFO simply generate its very first value (as determined by the combination of the **Waveform**, **Start Phase**, **Shape**, and **Offset**), and then holds that value until the end of the note.

You can use this in conjunction with the Random waveforms to create static, random modulation, with the value changing only at note-on.

Off (unchecked): When Stop is **Off**, the LFO will function normally.

Key Sync **[Off, On]**

On (checked): When Key Sync is **On**, the LFO starts each time you press a key, and an independent LFO runs for each note. This is the normal setting.

Off (unchecked): When Key Sync is **Off**, the LFO starts from the phase determined by the first note in the phrase, so that the LFOs for all notes being held are synchronized together. The Fade and Delay settings will only apply to the first note’s LFO.

Note that even if Key Sync is Off, each note’s LFO speed may still be different if you modulate the Frequency by note number, velocity, key scaling, or other note-specific AMS sources.

Offset **[–99...+99]**

By default, almost all of the LFO waveforms are centered around 0, and then swing all the way from –99 to +99. This parameter lets you shift the LFO up and down, so that—for instance—it’s centered on 50, and then swings from –49 to +149.

For example, let’s say that you’re using an LFO for vibrato. If the Offset is **0**, the vibrato will be centered on the note’s original pitch, bending it both up and down.

If the Offset is **+99**, on the other hand, the vibrato will only raise the pitch above the original note.

Offset settings and pitch change produced by vibrato

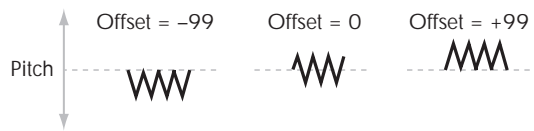

The one exception to this is the Guitar waveform, which is designed to emulate bending a string on a guitar—so that the pitch only goes up, and not down. Because of this, the waveform is centered on 50, and not on 0. Of course, you can always use a negative Offset to shift it back down below 0 again!

Since Offset affects the output values of the LFO, it's important to note that it affects the signal *after* the Shape function, as shown below:

LFO Signal Flow

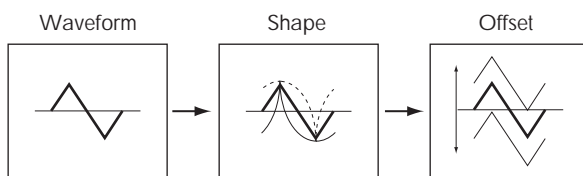

Fade [00...99]

The LFO can fade in gradually, instead of simply starting immediately at full strength. This parameter specifies the time from when the LFO begins to play until it reaches its maximum amplitude.

If the Delay parameter is being used, then the fade will begin after the delay is complete.

When **Key Sync** is **Off**, the fade will apply only to the first note in the phrase.

LFO Fade and Delay

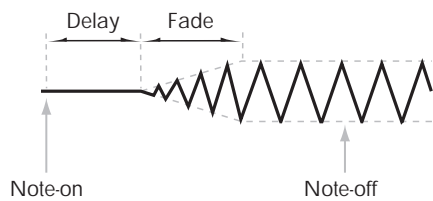

Delay [00...99]

This sets the time from note-on until the LFO starts.

When **Key Sync** is **Off**, the delay applies only to the first note of the phrase.

5-1b: Frequency Modulation

You can use two alternate modulation sources (AMS) to adjust the speed of the LFO.

AMS1 (Frequency) [List of AMS Sources]

This selects the first modulation source for the LFO's frequency. For a list of AMS sources, see "Alternate Modulation Source (AMS) List" on page 903.

Note that you can use LFO2 to modulate LFO1's frequency.

Intensity [-99...+99]

This sets the initial amount of AMS1. The Intensity Mod AMS then adds to this initial amount.

When AMS1 is at its maximum value (for instance, when the joystick is pushed all the way up), the AMS affects the frequency as shown below:

| Intensity | Change to LFO Frequency | |
|-----------|-------------------------|--------|
| +99 | 64x | Faster |
| +82 | 32x | |
| +66 | 16x | |
| +49 | 8x | |
| +33 | 4x | |
| +16 | 2x | |
| -16 | 1/2x | Slower |
| -33 | 1/4x | |
| -49 | 1/8x | |
| -66 | 1/16x | |
| -82 | 1/32x | |
| -99 | 1/64x | |

Intensity Mod AMS [List of AMS Sources]

This selects a secondary AMS modulation source to scale the intensity of AMS1.

For a list of AMS sources, see "Alternate Modulation Source (AMS) List" on page 903.

Intensity [-99...+99]

This controls the depth and direction of the Intensity Mod AMS. Even if the main AMS1 Intensity is set to 0, Intensity Mod AMS can still control the final amount of AMS A over the full +/-99 range.

For example, if **AMS1** is set to the **Pitch EG**, and **Intensity Mod AMS** is set to **JS + Y**, positive settings mean that pushing the joystick away from yourself will increase the intensity of the Pitch EG modulation of LFO Frequency.

AMS2 (Frequency) [List of AMS Sources]

This selects the second modulation source for the LFO's frequency. For a list of AMS sources, see "Alternate Modulation Source (AMS) List" on page 903.

Intensity [-99...+99]

This controls the amount of modulation from AMS2.

5-1c: Frequency MIDI/Tempo Sync

MIDI/Tempo Sync [Off, On]

On (checked): The LFO will synchronize to the system tempo, as set by either the Tempo knob or MIDI Clock. The LFO speed will be controlled by the **Base Note** and **Times** parameters, below. All settings for **Frequency** and **Frequency Modulation** will be ignored.

Off (unchecked): The Frequency settings will determine the speed of the LFO, and the tempo settings will have no effect.

Base Note [♪...o]

This sets a basic rhythmic value for the LFO speed, relative to the system tempo. The values range from a 32nd note to a whole note, including triplets. It applies only when **MIDI/Tempo Sync** is **On**.

Times

[01...32]

This multiplies the length of the **Base Note**. For instance, if the **Base Note** is set to a sixteenth note, and Times is set to 3, the LFO will cycle over a dotted eighth note.

✓ **5-1: Page Menu Commands**

- Compare →p.112
- Write Program →p.112
- Exclusive Solo →p.113
- Swap LFO 1&2 →p.121
- PAGE →p.126
- MODE →p.126

5-2: OSC1 LFO2 AMSource

This is Oscillator 1's second LFO. Its parameters are exactly the same as those for the first LFO, as described under "5-1: OSC1 LFO1" on page 83—except that LFO1 cannot modulate LFO2.

5-5: OSC2 LFO1 AMSource

This page controls Oscillator 2's first LFO. It is available only when the **Oscillator Mode** is set to **Double**; if not, the page will be grayed out.

The parameters are identical to those for Oscillator 1, as described under "5-1: OSC1 LFO1" on page 83.

5-6: OSC2 LFO2 AMSource

This page controls Oscillator 2's second LFO. It is available only when the **Oscillator Mode** is set to **Double**; if not, the page will be grayed out.

Its parameters are exactly the same as those for the first LFO, as described under "5-1: OSC1 LFO1" on page 83—except that LFO1 cannot modulate LFO2.

5–9: Common LFO AMSource

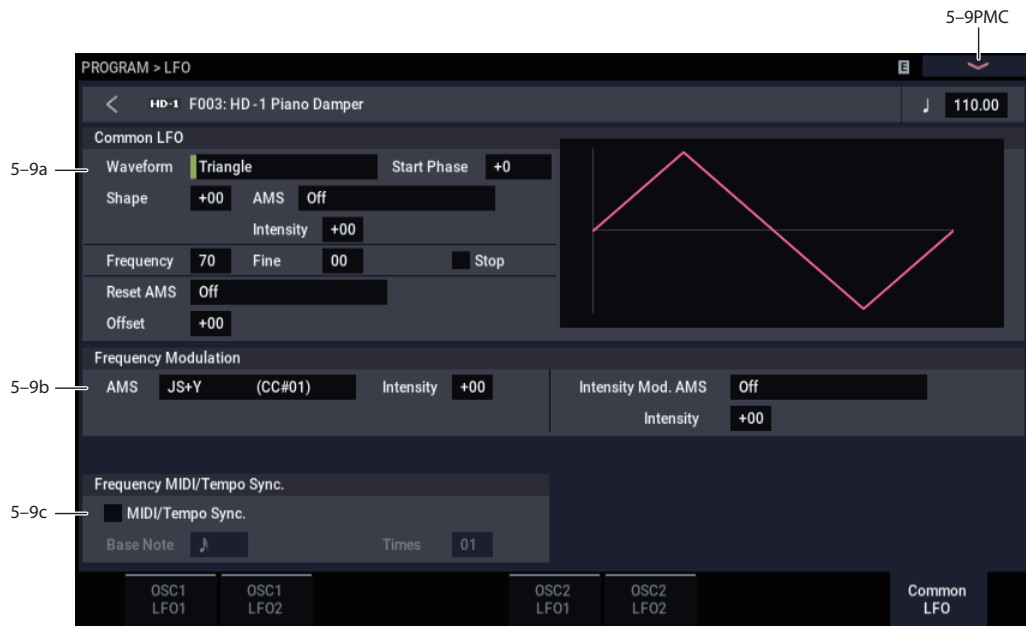

This is a single, free-running LFO, global for all voices in the Program—like the modulation LFOs in some vintage analog synths.

Differences from LFO1/2

The Common LFO starts running as soon as you select the Program, and only resets when you tell it to do so explicitly via the Reset Source control, below. This is different from LFO1/2's Key Sync parameter, which resets whenever all notes are released.

The Common LFO's persistence can be handy if you want to create a constant rhythm with an LFO, and then play “underneath” that rhythm without re-triggering it. For instance, you can use a MIDI controller in your sequencer to reset the Common LFO every few bars, regardless of what notes are being played.

The Common LFO has most of the same controls as LFO1/2. However, it does not include the Delay, Fade, and Key Sync settings, since these only make sense for per-voice LFOs.

5–9a: Common LFO

Waveform [Triangle...Random6 (Continuous)]

This selects the basic LFO waveform. For a complete list of the waveforms and more details, please see the entry under LFO1 “Waveform,” on page 83.

Start Phase [–180...+180, Random]

The Reset Source, described above, lets you reset the Common LFO. This is the phase from which the LFO will start when it is reset.

Shape [–99...+99]

Shape adds curvature to the basic waveform. For more details, please see the entry under LFO1 “Shape,” on page 84.

Note: Shape does **not** affect the Square and Random 3 waveforms, since their values are always either +99 or –99.

AMS (Shape)

[List of AMS Sources]

This selects a modulation source for controlling the LFO's Shape. Modulating the shape can dramatically alter the effect of the LFO—try it out!

For a list of AMS sources, see “Alternate Modulation Source (AMS) List” on page 903.

Intensity [–99...+99]

This controls the depth and direction of the Shape modulation.

Frequency [00...99]

This controls the speed of the LFO, before any modulation. Higher values mean faster speeds. For a complete description, please see the entry under LFO1 “Frequency,” on page 84.

Frequency Fine [00...99]

This allows you to control the LFO frequency with greater precision, giving you 98 additional steps for each step of the main Frequency parameter.

When this is set to 00, the LFO speed is as set by the Frequency parameter.

When this is set to 99, it's the same as increasing the main Frequency value by 1.

Stop [Off, On]

On (checked): When Stop is **On**, the LFO does not advance, and the Frequency parameters are ignored. Instead, the LFO simply generate a single value when the Program is selected, and then holds that value until you select another Program, or until you reset the LFO via AMS.

Note: This is different from LFO1/2, in which the value is reset with every note-on.

You can use this in conjunction with the Random waveforms to create static, random modulation, with the value changing only when you first select the Program.

Off (unchecked): When Stop is **Off**, the LFO will function normally.

Reset AMS [List of AMS Sources]

This selects an AMS source to reset the LFO to the Start Phase. The LFO resets when the AMS value passes the halfway mark: +50 for most AMS sources, or 64 for MIDI controllers.

To create an effect similar to the per-voice LFO's **Key Sync Off** setting, set this to **Gate 1+ Damper**.

Offset [-99...+99]

By default, almost all of the LFO waveforms are centered around 0, and then swing all the way from -99 to +99. This parameter lets you shift the LFO up and down, so that—for instance—it's centered on 50, and then swings from -49 to +149.

For a complete description, please see the entry under LFO1 "Offset," on page 84.

5-9b: Frequency Modulation

These parameters are identical to the Frequency Modulation settings for LFO1, as described under "5-1b: Frequency Modulation," on page 85.

5-9c: Frequency MIDI/Tempo Sync

These parameters are identical to the Frequency MIDI/Tempo Sync for LFO1, as described under "5-1c: Frequency MIDI/Tempo Sync," on page 85.

✓ 5-9: Page Menu Commands

- Compare →p.112
- Write Program →p.112
- Exclusive Solo →p.113
- PAGE →p.126
- MODE →p.126

PROGRAM > AMS Mixer/Common KeyTrack

Each Oscillator has two AMS Mixers, which are simple but powerful tools for combining and modifying AMS signals.

The two Oscillators also share two Common keyboard tracking generators, in addition to the dedicated keyboard tracking for the Filter and Amp.

These pages let you control all of these modulation sources.

Note that when the **Oscillator Mode** is set to **Single**, only Oscillator 1's AMS Mixers are active; the pages for Oscillator 2 will be grayed out.

6-1: OSC 1 AMS Mix

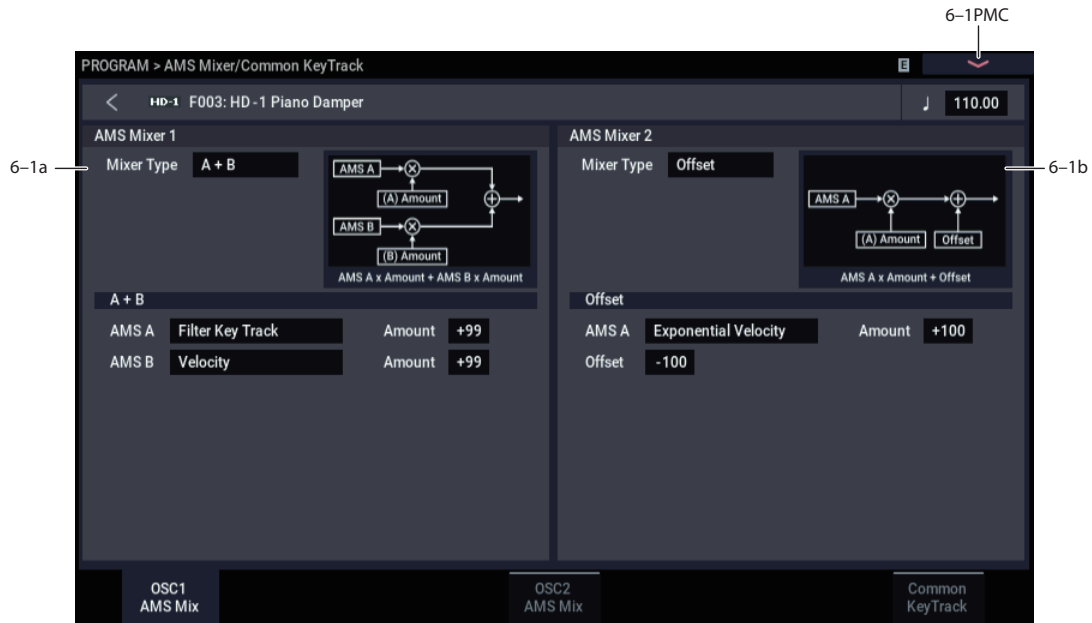

The AMS Mixers combine two AMS sources into one, or process an AMS source to make it into something new.

For instance, they can add two AMS sources together, or use one AMS source to scale the amount of another. You can also use them to change the shapes of LFOs and EGs in various ways, modify the response of realtime controllers, and more.

The AMS Mixer outputs appear in the list of AMS sources, just like the LFOs and EGs.

This also means that the original, unmodified inputs to the AMS Mixers are still available as well. For instance, if you use LFO 1 as an input to a AMS Mixer, you can use the processed version of the LFO to control one AMS destination, and the original version to control another.

Finally, you can cascade the two AMS Mixers together, by using AMS Mixer 1 as an input to AMS Mixer 2.

6-1a: AMS Mixer 1 AMSource

Mixer Type [A+B, Amt Ax B, Offset, Smoothing, Shape, Quantize, Gate]

This controls the type of processing performed by AMS Mixer 1. Each of the Mixer Types is discussed in detail over the next several pages.

A+B adds two AMS sources together. For more information, see “A+B” on page 90.

Amt Ax B scales the amount of one AMS source with the other. See “Amt A x B” on page 90 for more details.

Offset adds or subtracts a constant value to or from an AMS source. For more information, see “Offset” on page 91.

Smoothing creates more gentle transitions between values, smoothing out abrupt changes such as a quick move on a joystick or a sharp edge on an LFO. For details, see “Smoothing” on page 92

Shape adds curvature to the AMS input. For an in-depth description, see “Shape” on page 92.

Quantize turns smooth transitions into discrete steps. See “Quantize” on page 93 for more information.

Gate chooses between two AMS inputs (or fixed values) based on a third AMS source. See “Gate” on page 93 for more information.

A+B

AMS Mixer, Type = A+B

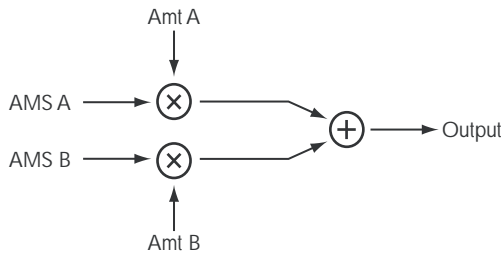

A+B merges two AMS sources into one. This can be handy when you need to add one more modulation source to a parameter, but you've already used up all of the available AMS slots.

For instance, let's say that you're using an LFO to modulate Filter Resonance, and then you decide that it would be interesting to scale that parameter with an EG as well. Resonance has only a single AMS input, but you can easily merge the LFO and the EG together using the A+B AMS Mixer:

1. Assign the LFO to AMS A.
2. Assign the EG to AMS B.
3. Assign the AMS Mixer as the Filter Resonance AMS source.

AMS Mixer A+B example

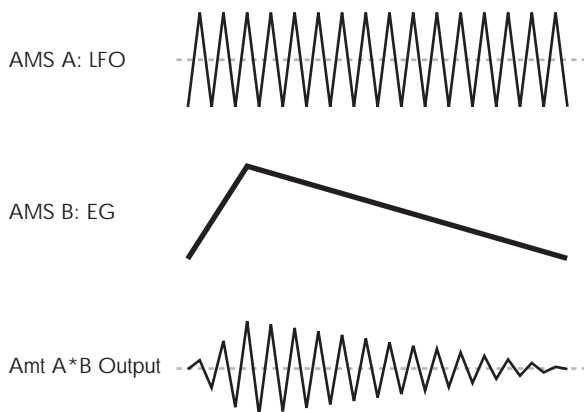

AMS A [List of AMS Sources]

This selects the first AMS input.

For a list of AMS sources, see "Alternate Modulation Source (AMS) List" on page 903.

AMS A Amount [-99...+99]

This controls the depth and direction of the AMS A input.

AMS B [List of AMS Sources]

This selects the second AMS input.

For a list of AMS sources, see "Alternate Modulation Source (AMS) List" on page 903.

AMS B Amount [-99...+99]

This controls the depth and direction of the AMS B input.

Amt A x B

AMS Mixer, Type = A x B

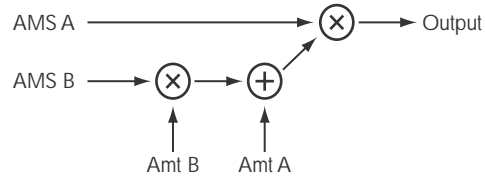

This Mixer Type uses AMS B to scale the amount of AMS A. For instance, you can control the amount of LFO1 with the Filter EG or the amount of the Pitch EG with the Joystick +Y.

AMS Mixer Amt AxB example

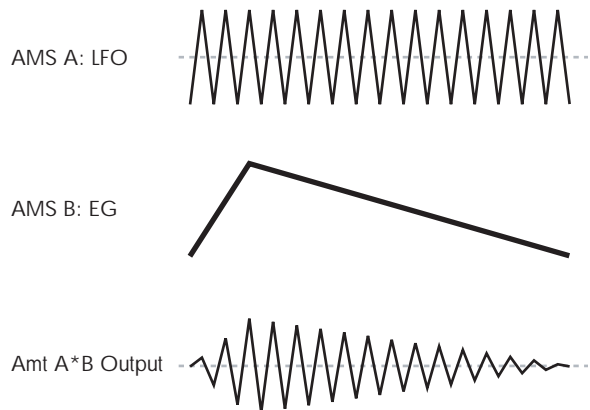

AMS A [List of AMS Sources]

This selects the first AMS source, which can then be scaled by AMS B. For a list of AMS sources, see "Alternate Modulation Source (AMS) List" on page 903.

AMS A Amount [-99...+99]

This controls the initial amount of AMS A, before modulation from AMS B. Input from AMS B then adds to this initial amount.

Even if Amount A is set to 0, AMS B can still control the final amount of AMS A over the full +/-99 range.

AMS B [List of AMS Sources]

This selects the second AMS source, to scale the amount of AMS A. For a list of AMS sources, see "Alternate Modulation Source (AMS) List" on page 903.

AMS B Amount [-99...+99]

This controls the depth and direction of the AMS B modulation of AMS A.

For example, if AMS A is set to LFO 1 and AMS B is set to the Filter EG, positive settings mean that the EG will increase the amount of LFO1.

Tips for using Amt A x B

Using SW 1/2 to turn an AMS source on and off

You can use Amt AxB to "gate" an AMS source:

1. Set AMS A to the desired source, and set AMS A Amount to 0.
2. Set AMS B to SW 1 or 2, and AMS B Amount to +99. Now, SW1 or 2 will turn AMS A on and off.

Muting individual Wave Sequence steps with SW1

You can use AMS Mixers in conjunction with the AMS outputs of Wave Sequences. For instance, you can use SW1 to turn one or more steps of a Wave Sequence on or off. To do this:

1. In the Oscillator which uses the Wave Sequence, set an AMS Mixer to Amt A*B.
2. In the AMS Mixer, set AMS A to Wave Sequence AMS Output 2.

In the same AMS Mixer:

3. Set AMS B to SW1.
4. Set AMS A Amount to 0.
5. Set AMS B Amount to +99.

Now, SW1 will “gate” Wave Sequence AMS Output 2.

Next, in the Wave Sequence:

6. For the step(s) you’d like to mute, set the AMS Output 2 to +127.

Leave all other steps set to 00.

Back in the Oscillator which uses the Wave Sequence:

7. Set the Amp AMS source to the AMS mixer you set up in step 1, above.
8. Set the AMS Intensity to -99.

Now, when SW1 is On, the steps you set up in (6) will be muted.

When SW1 is Off, they’ll sound normally.

Offset

AMS Mixer, Type = Offset

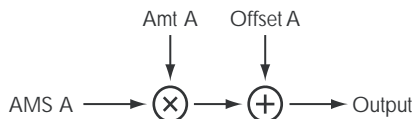

This simple processor adds a constant positive or negative offset to an AMS source, and also allows you to double the gain. Among other things, you can use this to convert a bipolar AMS source (both negative and positive) to a unipolar source (positive only), or vice-versa.

AMS A [List of AMS Sources]

This selects the AMS source to be offset.

For a list of AMS sources, see “Alternate Modulation Source (AMS) List” on page 903.

AMS A Amount [-199...+199]

This controls the basic level of AMS A.

+199 doubles the original signal level, while -199 doubles the level and inverts the phase. The values are clipped only at the output; internally, they can be greater than the normal range of -99 to +99.

AMS A Offset [-199...+199]

This controls the amount of offset for AMS A.

Setting Offset to +199 shifts an AMS input of -99 all the way to +99. In conjunction with high Amount values, this can be useful for creating clipped shapes, such as shown in the last of the “AMS Mixer Offset examples,” above.

AMS Mixer Offset examples

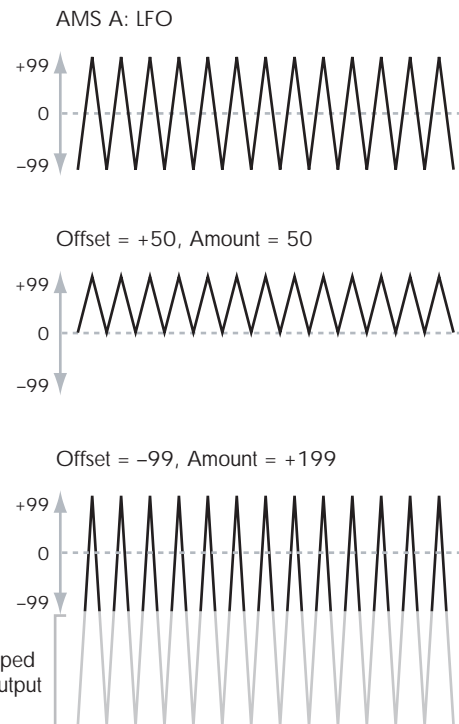

Tips for using Offset

Converting from bipolar to unipolar

You can use the Offset function to convert a bipolar AMS source (both negative and positive), such as an LFO, to a unipolar signal (positive only). To do so:

1. Select the LFO as the AMS A input.
2. Set the AMS A Amount to 50.

This cuts the overall level of the LFO in half, so that instead of swinging between -99 and +99, it only swings between -50 and +50.

3. Set the AMS A Offset to 50.

This shifts the LFO signal up, so that it now swings between 0 and +99.

Converting from unipolar to bipolar

Similarly, you can convert a unipolar AMS source (positive only), such as a knob, joystick, etc., to a bipolar signal (both negative and positive). To do so:

1. Select the AMS source as the AMS A input.
2. Set the AMS A Amount to +199.

This doubles the overall level of the AMS source, so that instead of ranging from 0 to +99, it now goes from 0 to +199.

3. Set the AMS A Offset to -100.

This shifts the AMS signal down, so that it ranges from -99 to +99.

Smoothing

This Mixer Type smooths out the AMS input, creating more gentle transitions between values. You have separate control of the amount of smoothing during the attack (when the signal is increasing) and decay (when it's decreasing).

The higher the Attack and Decay settings, the more that the input will be smoothed.

Low settings provide subtle controller smoothing. Higher settings create auto-fade effects, transforming a quick gesture into a longer fade-in and/or fade-out event.

Smoothing can also be used to alter the shape of programmable mod sources, such as LFOs and EGs. For instance, you can turn a “blip” into a simple envelope shape, as shown below.

AMS Mixer Smoothing examples

Original AMS A: Smoothing with Long Attack and Short Release:



Smoothing with Short Attack & Long Release:



AMS A [List of AMS Sources]

This selects the AMS source to be smoothed.

For a list of AMS sources, see “Alternate Modulation Source (AMS) List” on page 903.

AMS A Attack [00...+99]

This controls the attack time of the smoother, or how long it takes the smoother to reach a new, *higher* value.

Higher Attack settings mean longer times.

Depending on how quickly the AMS input value is changing, high Attack settings may mean that the value is never quite reached, as shown in “AMS Mixer Shape examples,” above.

AMS A Decay [00...+99]

This controls the decay time of the smoother, or how long it takes the smoother to reach a new, *lower* value.

Higher Decay settings mean longer times.

Shape

This Mixer Type adds curvature to the AMS input. Shape can create custom controller curves, such as exponential joystick, logarithmic velocity, and so on. It can also alter the shape of programmable modulation sources, such as EGs and LFOs.

Note: Shape only affects AMS signals which already have some amount of slope, such as EGs, triangle and sine LFOs, and so on. It does not affect signals which only contain abrupt transitions, such as square waves.

AMS A [List of AMS Sources]

This selects the AMS input source to be shaped.

For a list of AMS sources, see “Alternate Modulation Source (AMS) List” on page 903.

Mode [Symmetric, Asymmetric]

This selects whether Shape will produce one or two curves. The graphic “AMS Mixer Shape examples” may help to visualize how this works.

Asymmetric will produce a single curve, extending from –99 to +99.

Symmetric will produce two matching curves extending outwards from 0 to –99 and +99, respectively.

Shape [–99...+99]

This controls the amount of curvature, and whether the curves are concave or convex. As you can see in the graphic examples, the shape will tend to emphasize certain value ranges, and de-emphasize others.

For example, let's say that you are using a triangle LFO, through Shape, to modulate filter cutoff. If Shape emphasizes the high value range, the filter will spend more time at the higher frequencies. If it emphasizes the low range, the filter will spend more time at the lower frequencies.

Here's a handy chart which shows the results of Shape with the different settings and input types:

| Mode | Input | Shape | Result |
|------------|----------|--------------|--|
| Symmetric | Unipolar | Positive (+) | emphasizes upper value range |
| | | Negative (-) | emphasizes lower value range |
| | Bipolar | Positive (+) | emphasizes both upper and lower value ranges, and de-emphasizes the center |
| | | Negative (-) | emphasizes center value range, around 0 |
| Asymmetric | Unipolar | Positive (+) | emphasizes extreme upper range, with offset |
| | | Negative (-) | emphasizes extreme lower range, with offset |
| | Bipolar | Positive (+) | emphasizes upper value range |
| | | Negative (-) | emphasizes lower value range |

AMS Mixer Shape examples

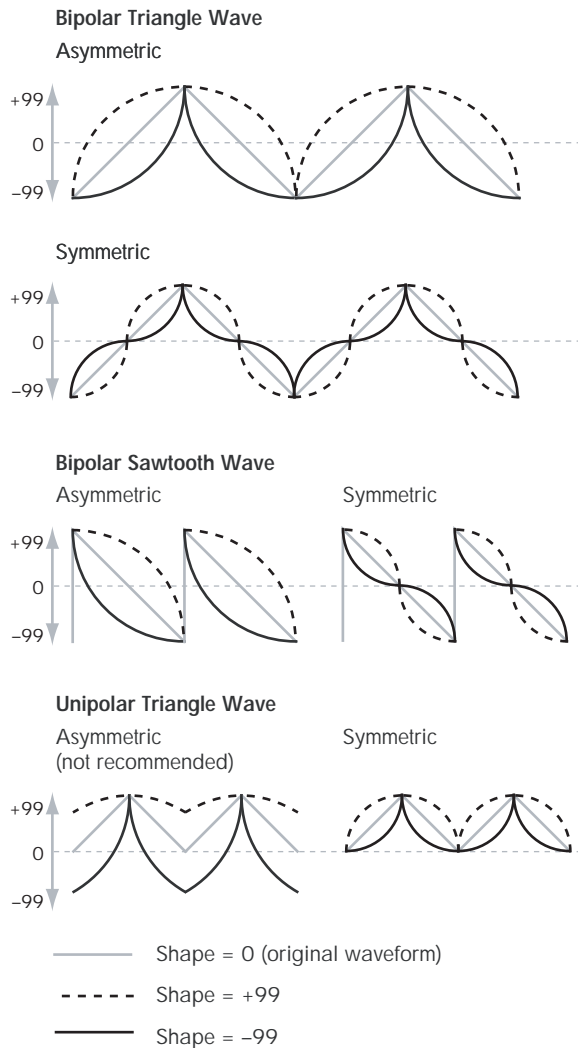

Bipolar and Unipolar AMS sources

To understand Shape, it helps to understand the difference between **bipolar** and **unipolar** AMS sources.

Bipolar sources can swing all the way from -99 to +99, with 0 in the middle. Most LFOs are bipolar, for instance; so is Pitch Bend.

Generally, bipolar AMS sources will work better with the **Asymmetric** mode, but **Symmetric** may also produce interesting results.

Unipolar sources only go from 0 to 99, with 50 in the middle. MIDI controllers, such as JS+Y (CC#1), are all unipolar. In practice, EGs are usually programmed to be unipolar, even though the Filter and Pitch EGs do allow both positive and negative levels.

With unipolar sources, it's almost always better to use the **Symmetric** mode. The **Asymmetric** mode can cause offsets and other strange results.

Quantize

This Mixer Type changes the input from a continuous signal into a series of discrete steps. Instead of moving smoothly between values, it will snap immediately from one value to another.

You can use this to change the shape of LFOs or EGs, or to force a controller to land on a few specific values.

AMS Mixer Quantize examples

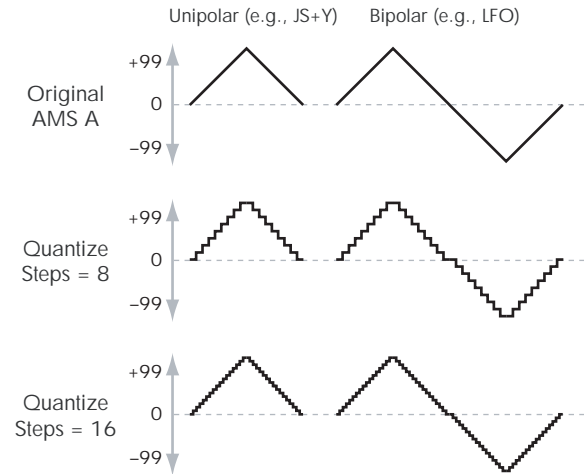

AMS A

[List of AMS Sources]

This selects the AMS input source to be quantized.

For a list of AMS sources, see "Alternate Modulation Source (AMS) List" on page 903.

AMS A # Of Steps

[2...32]

This controls the severity of the effect. The lower the number of steps, the more "steppy" the output will be.

For instance, when this is set to 2, there will be "steps" at 0, 50, and 99. With a bipolar AMS input, there will also be steps at -50 and -99.

As another example, when it is set to 5, there will be steps at 0, 20, 40, 60, 80, and 99 (as well as -20, -40, -60, -80, and -99 for bipolar inputs).

Gate

AMS Mixer, Type = Gate

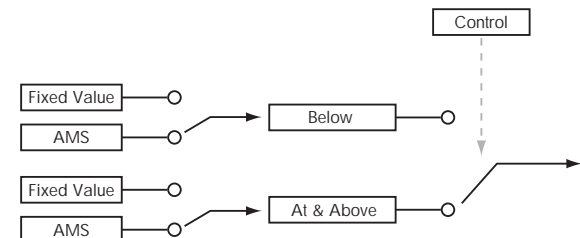

This Mixer Type lets you set up two different AMS sources (or fixed AMS amounts), and then switch between the two using a third AMS source.

It's similar to an audio gate with a side-chain, but with even more flexibility—since you get to choose what happens when the gate is closed (below the threshold), as well as when it's open (above the threshold).

You can also choose whether the gate will be able to open and close continuously in response to the control source, or whether it only opens or closes at the beginning of the note, and then stays that way over the note's entire duration.

You can use the Gate to:

- Use a foot-switch (or other controller) to apply pitch-bend or other effects to some notes, but not to others
- Apply controllers to a parameter only after the controller reaches a certain threshold—for instance, use Velocity to control harmonics in the STR-1, but only once Velocity is greater than 90
- Use a joystick, button, or other controller to switch between two different LFOs (or any two AMS sources)

Gate Control

Source [List of AMS Sources]

This selects the AMS source to control the gate.

Control at Note-On Only [Check-box]

When this is enabled (checked), the value of the **Control Source** at note-on will select the output (**Below Threshold** or **At & Above Threshold**). The selected output will then remain active throughout the duration of the note, regardless of any subsequent change in the **Control Source**'s value.

Note that the output value itself can continue to change; only the selection of **Below** or **At & Above** is fixed.

Threshold [-99...+99]

This sets the value of the **Control Source** at which the gate opens or closes.

Gate Output

If the value of the **Control Source** is less than the **Threshold**, the Gate outputs the preset value or AMS source selected under **Below Threshold**.

If the value of the **Control Source** is greater than or equal to the **Threshold**, the Gate outputs the preset value or AMS source selected under **At & Above Threshold**.

Below Threshold [Fixed Value, AMS A]

This selects whether **Below Threshold** uses a preset value, or the selected AMS source.

Fixed Value [-99...+99]

This lets you set a specific value to be used when the **Control Source** is less than the **Threshold**. This only applies when **Below Threshold** is set to **Fixed Value**.

AMS A [List of AMS Sources]

This lets you set an AMS source to pass through the Gate when the **Control Source** is less than the **Threshold**. This only applies when **Below Threshold** is set to **AMS A**.

At & Above Threshold [Fixed Value, AMS B]

This selects whether **At & Above Threshold** uses a preset value, or the selected AMS source.

Fixed Value [-99...+99]

This lets you set a specific value to be used when the **Control Source** is greater than or equal to the **Threshold**. This only applies when **At & Above Threshold** is set to **Fixed Value**.

AMS B [List of AMS Sources]

This lets you set an AMS source to pass through the Gate when the **Control Source** is greater than or equal to the **Threshold**. This only applies when **At & Above Threshold** is set to **AMS B**.

Tips for using Gate

Selective pitch-bend, using only the joystick

You can also use a single AMS source as both the Control Source and a value source:

1. Set the Control Source to JS X.
2. Set Control At Note-On Only to On (checked).
3. Set the Threshold to 00.
4. Set Below Threshold to AMS A: JS X.
5. Set At & Above Threshold to a Fixed Value of 00.
6. On the Pitch Mod page, assign the AMS Mixer to control the pitch.
7. Also on Pitch Mod, set the standard JS+X and JS-X amounts to 0.

This way, only the AMS Mixer's processed version of the joystick will affect the pitch.

8. With the joystick in the center, play a chord, and hold it through step 9.
9. Bend the joystick to the left, and then play a new note above the chord.
10. Use the joystick to bend the pitch of the new note.

The new note will bend, but the original chord (played before you bent the joystick down) will not. This method is particularly good for bending the top note of a chord up to pitch.

Generating a static value

Sometimes, it can be handy to have a preset value as an AMS source. The Gate is one way to create this. To do so:

1. Set both **Below Threshold** and **At & Above Threshold** to **Fixed Value**, and enter the same value into each.

Now, the AMS mixer will always generate this static value.

6-1b: AMS Mixer 2 AMSource

This is the second AMS Mixer for Oscillator 1. The parameters are exactly the same as those for AMS Mixer 1, as described under "6-1a: AMS Mixer 1" on page 89.

✓ 6-1: Page Menu Commands

- Compare →p.112
- Write Program →p.112
- Exclusive Solo →p.113
- Copy Oscillator →p.119
- Swap Oscillator →p.119
- PAGE →p.126
- MODE →p.126

6-5: OSC 2 AMS Mixer AMSource

This page controls the two AMS Mixers for Oscillator 2. These are available only when the **Oscillator Mode** is set to **Double**; if not, the page will be grayed out.

The parameters are identical to those for Oscillator 1, as described under “6-1: OSC 1 AMS Mix,” on page 89.

6-9: Common KeyTrack



The two Oscillators share two Common keyboard tracking generators, in addition to each Oscillator's dedicated keyboard tracking for the Filter and Amp. You can use these Common keytracks as AMS sources for modulating most AMS destinations.

The Common Key Track parameters are shared by the entire Program, but the actual AMS values are calculated individually for each voice.

Overview

What does Keyboard Tracking do?

At its most basic, keyboard tracking lets you vary the modulation amount as you play up and down the keyboard. This can be useful for making the timbre consistent across the entire range, or adjusting parameters according to pitch.

The NAUTILUS keyboard tracking can be fairly complex, if desired. You can create different rates of change over up to four different parts of the keyboard. For instance, you can:

- Make the modulation increase very quickly over the middle of the keyboard, and then increase more slowly—or not at all—in the higher octaves.
- Make the modulation increase as you play *lower* on the keyboard.
- Create abrupt changes at certain keys, for split-like effects.

Common Keyboard Tracking

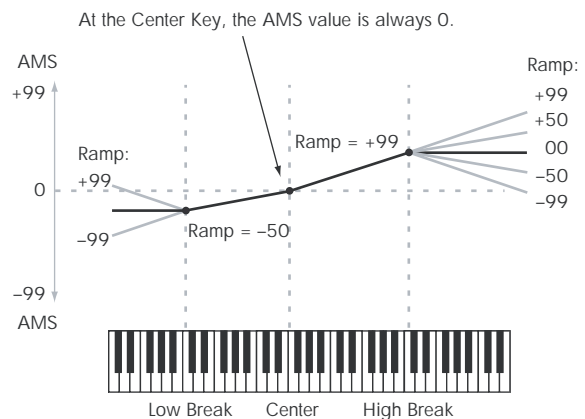

How it works: Keys and Ramps

The keyboard tracking works by creating four ramps, or slopes, between five keys on the keyboard. The bottom and top keys are fixed at the bottom and top of the MIDI range, respectively. You can set the other three keys—named Low Break, Center, and High Break—to be anywhere in between.

The four Ramp values control the rate of change between each pair of keys. For instance, if the Low-Center Ramp is set to 0, the value will stay the same between the Low Break key and the Center key.

You can think of the resulting shape as being like two folding doors attached to a hinge in the center. At the Center key (the main hinge), the keyboard tracking has no effect. The two folding doors swing out from this center point to create changes in the higher and lower ranges of the keyboard.

6-9a: Keyboard Track 1 AMSource

Key

Low Break [C-1...G9]

This sets the breakpoint note between the two lower ramps - the “hinge” of the lower door.

Center [C-1...G9]

This sets the center of the keyboard tracking - the main “hinge.” At this key, the keyboard tracking has no effect on the AMS destinations.

High Break [C-1...G9]

This sets the breakpoint note between the two higher ramps - the “hinge” of the upper door.

Entering notes from the keyboard

You can enter note numbers directly by playing them on the keyboard. To do so:

1. Select one of the Key parameters.
2. Hold down the ENTER key.
3. While holding ENTER, play a note on the keyboard.

Ramp

Positive ramp values mean that the keyboard tracking output increases as you play farther from the Center Key; negative ramp values mean that it decreases.

Because of this, the meanings of positive and negative ramp settings will change depending on whether the ramp is to the left or right of the Center Key.

Bottom-Low and Low-Center: negative ramps make the keyboard tracking’s output go down as you play lower on the keyboard, and positive ramps make the output go higher.

Center-High and High-Top: negative ramps make the keyboard tracking’s output go down as you play *higher* on the keyboard, and positive ramps make the output go up.

Bottom-Low [-Inf, -99...+99, +Inf]

This sets the slope between the bottom of the MIDI note range and the Low Break key. For normal key track, use negative values.

Low-Center [-Inf, -99...+99, +Inf]

This sets the slope between the Low Break and Center keys. For normal key track, use negative values.

Center-High [-Inf, -99...+99, +Inf]

This sets the slope between the Center and High Break keys. For normal key track, use positive values.

High-Top [-Inf, -99...+99, +Inf]

This sets the slope between the High Break key and the top of the MIDI note range. For normal key track, use positive values.

The table below shows how the ramps affect the AMS output:

| Ramp value | AMS change |
|------------|----------------------------|
| -Inf | goes to -99 in 1 half-step |
| -99 | -20 per octave |
| -50 | -10 per octave |

| Ramp value | AMS change |
|------------|----------------------------|
| 0 | no change |
| +50 | +10 per octave |
| +99 | +20 per octave |
| +Inf | goes to +99 in 1 half-step |

+Inf and -Inf ramps

+Inf and -Inf are special settings which create abrupt changes for split-like effects. When a ramp is set to +Inf or -Inf, the keyboard tracking will go to its extreme highest or lowest value over the span of a single key.

+Inf and -Inf Ramps

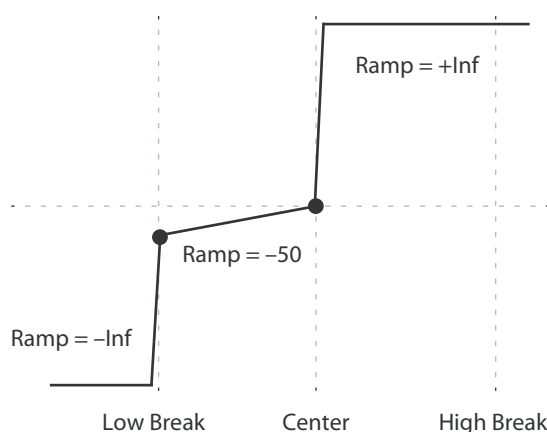

Note: If you set the Center-High ramp to +Inf or -Inf, the High-Top parameter will be grayed out. Similarly, if you set the Low-Center ramp to +Inf or -Inf, the Bottom-Low ramp will be grayed out.

6-9b: Keyboard Track 2 AMSource

This is the second Common keyboard tracking generator.

Its parameters are exactly the same as those for Keyboard Track 1, as described under “6-9a: Keyboard Track 1” on page 97.

✓ 6-9: Page Menu Commands

- Compare →p.112
- Write Program →p.112
- Exclusive Solo →p.113
- Copy Oscillator →p.119
- Swap Oscillator →p.119
- PAGE →p.126
- MODE →p.126

PROGRAM > IFX

These pages let you can make settings for the insert effects. For instance, you can:

- Send the output of an oscillator to an insert effect
- Route a sound to an insert effect

- Make detailed settings for insert effects
- Make common LFO settings for effects

For more information, please see “Effect Guide” on page 731.

8-1: Routing

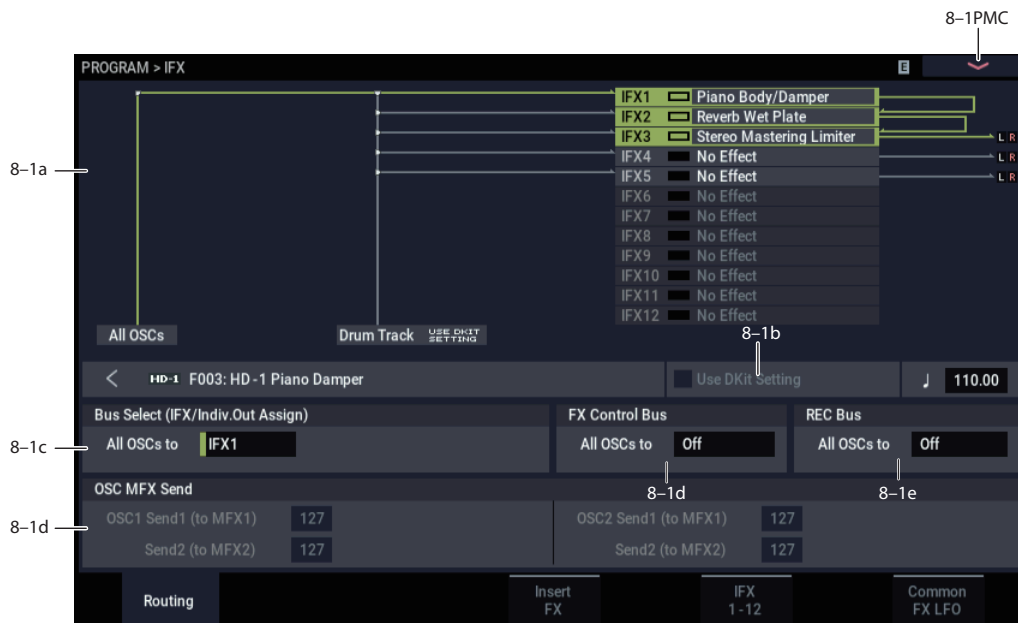

8-1a: Routing Map

This graphic shows an overview of the insert effects, including the routing of the oscillators to the effects, the effects names and on/off status, chaining between the effects, and the output bus to which the insert effects are themselves routed.

This page lets you adjust the routing of the oscillators to the insert effects. To adjust the other settings shown in this graphic, see “8-5: Insert FX,” as described on page 101.

Note: Configure the routing for the drum track in “Bus”, Scene Common Setup on the ARP DRUM page. For more information, see “Bus” on page 17.

Tip: Most of the factory Drum Kits use standard **Bus Select** settings, as detailed below:

- Snares → IFX1
- Kicks → IFX2
- Toms → IFX3
- Cymbals → IFX4
- Percussion, etc. → IFX5

Off (unchecked): The Program’s normal settings for **Bus Select**, **FX Control Bus**, and **OSC MFX Send** will be used; see below for more information on these parameters. All drum instruments will be sent to the same busses.

8-1b: Use Dkit Setting

Use Dkit Setting [Off, On]

This is shown if **Oscillator Mode** is set to **Drums** or **Double Drums**. If **Oscillator Mode** is set to **Single** or **Double**, it is ignored. For more information, please see “Oscillator Mode” on page 35.

On (checked): Drum Kits can have different **Bus Select (IFX/Indiv.Out Assign)**, **FX Control Bus**, **Send1 (to MFX1)**, and **Send2 (to MFX2)** settings (GLOBAL 4-3b) for each note. When **Use Dkit Setting** is **On**, these per-key settings will be used. You can use this to apply individual insert effects to specific drum instruments, or to send specific drum instruments to individual outputs.

Use Dkit Setting = On

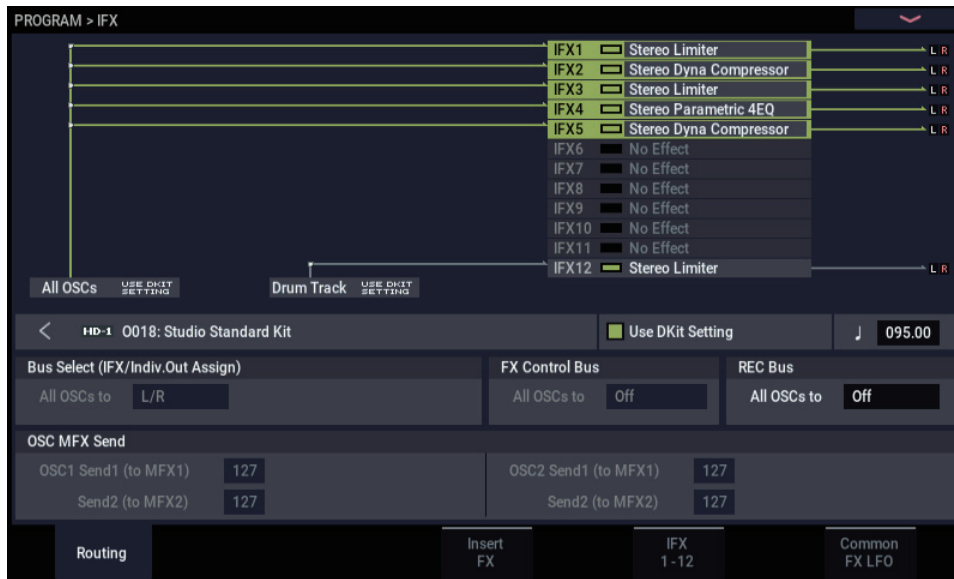

8-1c: Bus Select

Bus Select (IFX/Indiv.Out Assign) (All OSCs to) [L/R, IFX1...12, 1...4, 1/2, 3/4, Off]

This specifies the output bus for both oscillators 1 and 2.

L/R: The oscillators will go to the L/R bus. This is the default setting.

IFX1...12: The oscillators will go to the specified IFX bus.

1...4: The oscillators will be routed in mono to the specified AUDIO OUTPUT (INDIVIDUAL).

1/2...3/4: The oscillators will be routed in stereo, using the Pan setting (4-1c, 4-5: Amp2/Driver2), to the specified AUDIO OUTPUT (INDIVIDUAL) pair.

Off: The oscillators will not go to any of the outputs directly. You can use this to route the sound completely through the MFX. Use **Send1 (to MFX1)** and **Send2 (to MFX2)** to specify the send levels.

8-1d: FX Control Bus

All OSCs to [Off, 1, 2]

Sends the output of oscillators 1 and 2 to an FX Control bus (two-channel stereo FX Ctrl 1 or 2).

Use the FX Control busses when you want a separate sound to control the audio input of an effect. You can use two FX Control busses (each is a two-channel stereo bus) to control effects in various ways.

For more information, please see “FX Control Buses” on page 735.

8-1e: REC Bus

All OSCs to [Off, 1...4, 1/2, 3/4]

These settings send the output of oscillators 1 and 2 to the REC busses (four mono channels: 1, 2, 3, 4).

The REC busses are dedicated internal busses for recording, used for sampling in the various modes or for recording audio tracks in SEQUENCER mode.

In PROGRAM mode, you can resample your keyboard or Arpeggiator performance, or sample an external audio signal from the AUDIO INPUT jacks.

In order for you to sample, **Source Bus** must be set to a REC bus.

Normally you will set **Source Bus** to L/R so that you can sample the signal of the L/R bus line, such as your keyboard or Arpeggiator performance. However, you can use a REC bus if you want to sample only an audio input while performing on the keyboard or Arpeggiator function which are being output via L and R. If desired, multiple audio inputs can be mixed to a REC bus, or the direct signal from an audio input can be mixed to a REC bus along with the sound from an insert effect and sampled. For more information, see the diagram “Source Bus = REC Bus 1/2” on page 23.

Off: The signal will not be sent to a REC bus. This is the default.

1...4: The oscillators will be sent to the specified REC bus, in mono. The **Pan** settings (4-1c, 4-5: Amp2/Driver2) will be ignored.

1/2, 3/4: The oscillators will be sent in stereo to the selected pair of REC busses.

8-1f: OSC MFX Send

OSC1 Send1 (to MFX1) [000...127]

Sets the volume (send level) at which the output of oscillator 1 will be sent to master effect 1. This applies only when **Bus Select** (8-1c) is set to **L/R** or **Off**.

If **Bus Select** is set to **IFX1-IFX12**, the send levels to master effects 1 and 2 are set by **Send 1** and **Send 2** (8-5a) after passing through IFX1-12.

OSC1 Send2 (to MFX2) [000...127]

Sets the volume (send level) at which the output of oscillator 1 will be sent to master effect 2 (see “OSC1 Send1 (to MFX1)”).

OSC2 Send1 (to MFX1) [000...127]

OSC2 Send2 (to MFX2) [000...127]

Sets the volume (send level) at which the output of OSC2 will be sent to master effects 1 and 2. These parameters will be valid when **Oscillator Mode** is set to Double and **Bus Select** is set to L/R or Off.

MIDI CC#93 scales OSC 1/2's Send 1 level, and CC#91 scales the Send 2 level. These are controlled on the global **MIDI Channel** (GLOBAL 1-1a). The actual send level is determined by multiplying these values with the send levels of each oscillator.

✓ 8-1: Page Menu Commands

- Compare →p.112
- Write Program →p.112
- Exclusive Solo →p.113
- Copy Insert Effect →p.122
- Swap Insert Effect →p.123
- PAGE →p.126
- MODE →p.126

8-5: Insert FX



8-5a: IFX

Here you can choose effects for each of the 12 inserts, turn them on and off, configure chaining, and adjust the post-IFX mixer settings. Meters below the IFX labels display the effect output levels in realtime, showing the combined peak signals of the left and right channels.

For insert effects, the direct sound (Dry) is always stereo-in and out. The input/output configuration of the effect sound (Wet) depends on the effect type. For more information, please see “Insert Effects (IFX1...IFX12)” on page 739.

IFX1

IFX1 [000...197]

This selects the effect type for insert effect 1.

The meter below the label displays the effect’s output level in realtime, showing the combined peak signals of the left and right channels.

Category/IFX Select menu

When you press the popup button, the Category/IFX Select menu will appear, letting you select effects by category.

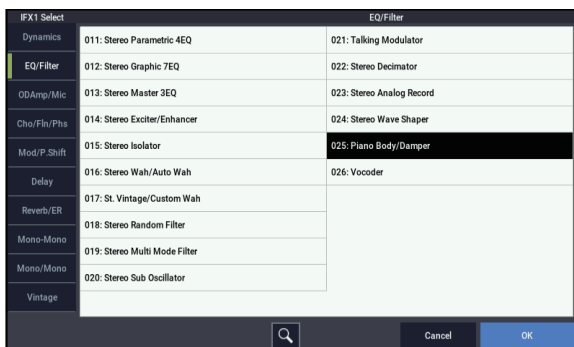

Use the tabs to select a category, and then select an effect within that category. Press the OK button to execute your selection, or press the Cancel button to cancel.

You can also use the Find button to search for effects by name. For more information, see “Find dialog” on page 7.

IFX1 On/Off [Off, On]

Switches the insert effect on/off. The setting will alternate between on and off each time you press the button.

If this is off, the input will simply be passed to the output. (When 000:No Effect is selected, there’s no audible difference between On and Off.) Note, however, that even when this is set to Off, the effect will continue to use processing power.

MIDI Separately from this setting, you can use MIDI CC #92 (on the global **MIDI Channel**) to turn all insert effects off. A value of 0 turns them off, and values of 1–127 restore the original setting.

Chain to [IFX2...IFX12]

You can chain up to twelve insert effects together in series, to create more complex effects. Set up the chain using this parameter, and then enable it using the **Chain** check box, below.

Effects must be chained in ascending numeric order. For example, IFX1 can be chained to any of IFX2 through IFX12, and IFX2 can be chained to IFX3 through IFX12.

You can chain two or more effects into the same downstream effect. For instance, both IFX1 and IFX2 can be chained to IFX6.

Effects can also join a chain in the middle. For instance, you can chain IFX3 to IFX4 to IFX9, and then chain IFX2 to IFX9 as well.

The **Pan (CC#8)**, **Bus Select**, **REC Bus**, and **Send1/2** settings apply only to the last effect in the chain. However, any effect in the chain can be sent to the FX Control buses.

Chain [Off, On]

This enables the chain, as set up by the **Chain to** parameter, above.

Pan (CC#8) (Post IFX Pan) [L000...C064...R127]

Specifies the panning immediately after the insert effect.

MIDI You can use CC#8 to control this.

Bus Sel. (Bus Select) [L/R, 1...4, 1/2...3/4, Off]

Specifies the bus to which the signal will be sent immediately after the insert effect.

L/R: The signal will be sent to the L/R bus, which passes through TFX 1 and 2 and then goes to the main L/R outputs. This is the default setting.

1...4: The signal will be sent, in mono, to the selected individual output.

1/2, 3/4: The signal will be panned by the **Pan (CC#8)** setting, and sent in stereo to the selected pair of audio outputs.

Off: The signal will not be sent directly to the outputs. This setting is useful if you want to:

- Use **Send 1** or **2** to route the signal entirely through the master effects, without sending the dry signal to the outputs.
- Use the **FX Control Bus** to route the signal to an effects side-chain, such as a gate or vocoder, without being heard directly at the outputs.
- Use the **REC Bus** to record the signal, without routing the signal directly to the outputs.

FX Control Bus [Off, 1, 2]

This sends the post-IFX signal to the FX Control busses. For more information, see “8-1d: FX Control Bus” on page 99.

REC Bus [Off, 1, 2, 3, 4, 1/2, 3/4]

Sends the post-IFX signal to the REC busses. For more information, see See “8-1e: REC Bus” on page 99. If you want to resample via the REC busses, set the sampling **Source Bus** (0-8d) to REC 1/2 or REC 3/4.

Send1 [000...127]**Send2 [000...127]**

These adjust the level at which the post-IFX signal is sent to master effects 1 and 2. This is valid if **Bus Select** (8-5a) is set to L/R or Off.

MIDI You can use CC#93 to control the Send 1 level, and CC#91 to control the Send 2 level. The global MIDI channel specified by **MIDI Channel** (GLOBAL 1-1a) is used for these messages.

IFX2...12

Here you can specify each insert effect’s effect type, on/off status, chaining, and mixer settings following the insert effect. With the exception of **Chain to** and **Chain**, the parameters are the same as for IFX1. See “IFX1” on page 101.

IFX2: Chain to [IFX3...IFX12]

IFX3: Chain to [IFX4...IFX12]

IFX4: Chain to [IFX5...IFX12]

IFX5: Chain to [IFX6...IFX12]

IFX6: Chain to [IFX7...IFX12]

IFX7: Chain to [IFX8...IFX12]

IFX8: Chain to [IFX9...IFX12]

IFX9: Chain to [IFX10...IFX12]

IFX10: Chain to [IFX11...IFX12]

IFX11: Chain to [(IFX12)]

These specify the chain destination for each insert effect. If **Chain** is enabled, the insert effect will be connected in series to the IFX specified by the **Chain to** setting.

The only chain destination for IFX11 is IFX12. You cannot chain IFX12 to another IFX.

Chain [Off, On]

Specifies whether insert effects will be connected in series.

If the **Chain** check box is on, this insert effect will be connected in series to the insert effect selected by “Chain to.” This is not available for IFX12.

Tip: If you move from this page to the IFX- IFX1-12 page, the IFX you choose here will be selected.

✓ 8-5: Page Menu Commands

- Compare →p.112
- Write Program →p.112
- Exclusive Solo →p.113
- Copy Insert Effect →p.122
- Swap Insert Effect →p.123
- Insert IFX Slot →p.123
- Cut IFX Slot →p.124
- Clean Up IFX Routings →p.124
- PAGE →p.126
- MODE →p.126

8-7: IFX 1-12

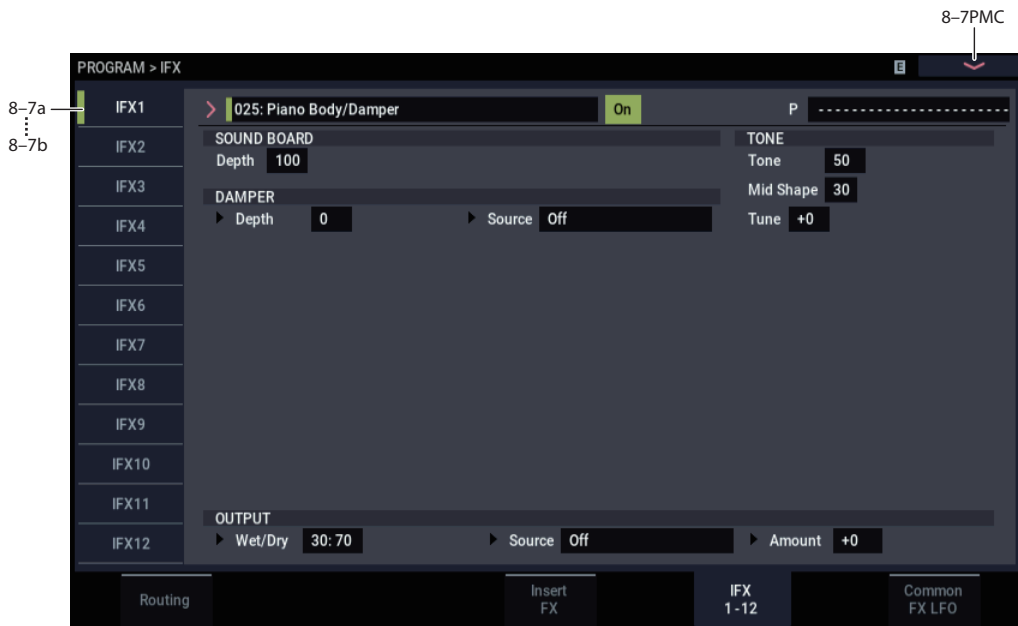

This page lets you edit the parameters of the insert effect 1. Use the tabs at left to select IFX1 through IFX12.

To select different effects types, use the Insert FX page. For more information, see “8-5: Insert FX” on page 101.

Effects Modulation: Dmod

Most effects have one or more parameters which can be modulated in realtime. In the NAUTILUS, this is called Dynamic Modulation, or Dmod for short.

For a complete list of Dmod sources, see “Dynamic Modulation Source List” on page 912.

MIDI Effect dynamic modulation (Dmod) is controlled on the global **MIDI Channel** (GLOBAL 1-1a). For more information, see “Dynamic modulation (Dmod) and Tempo Synchronization” on page 734.

8-7a: IFX1

This configures the parameters of insert effect 1. Use the tabs at the left to select IFX1-12.

IFX1 [000...197]

This selects the effect type for insert effect 1.

→ p.101 “IFX1”

IFX1 On/Off [Off, On]

This turns the insert effect on and off. It is linked with the on/off setting in the Insert FX page.

P (Effect Preset) [P00, P01...15, U00...15, -----]

This selects the effect preset.

Effect preset function

You can store the parameters for each effect on the NAUTILUS to internal memory. This function is called “effect presets”.

Effect parameters you edit are saved as part of each Program, but effect presets let you save the variations for the parameter settings per effect. The effect settings you like are saved as presets, and you can easily recall them from other Programs or modes.

The following presets can be saved to memory for each effect.

P00: Initial Set: These are the default settings that are recalled when you select an effect type. You can’t save your own settings here.

P01...P15: These usually contain Korg preset data (though some effects may not include presets). We recommend that you store your settings in U00-U15.

U00...U15: These are areas in which you can store your own settings.

Some effects do not contain preset data.

-----: This shows that no Effect Preset has been selected. You’ll see this if you’ve just selected an effect, written a Program, or selected a new Program. Selecting this setting from the menu will not have any effect.

Note: Programs save the effects parameter settings, but they don’t save the number of the selected Effect Preset. If you select an Effect Preset, and then save the Program, the Effect Preset setting will revert to “-----.”

Using Effect Presets

1. Select an effect in the Insert FX page.
2. The P00: Initial Set settings will be recalled. “P (Effect Preset)” will show -----.
3. Use “P (Effect Preset)” to select an effect preset: P00-P15 or U00-U15. The stored parameters will be recalled. Note that this will overwrite all parameters of the effect.
4. Edit the recalled parameters as desired.
5. You can save the settings for each program using the “Write Program” page menu command.

6. If you've come up with settings you like and want to save them as a new preset, use the **Write FX Preset menu command**.

IFX1 Parameters

Set the parameters for the effect type selected for insert effect 1.

For details on the specific parameters of each effect, please see "Insert Effects (IFX1...IFX12)" on page 739.

8-7b: IFX2...12

This configures the parameters of insert effects 2-12.

They have the same controls as described under "8-7a: IFX1," above.

✓ 8-7: Page Menu Commands

- Compare →p.112
- Write Program →p.112
- Exclusive Solo →p.113
- Copy Insert Effect →p.122
- Swap Insert Effect →p.123
- Write FX Preset →p.126

- PAGE →p.126
- MODE →p.126

8–9: Common FX LFO

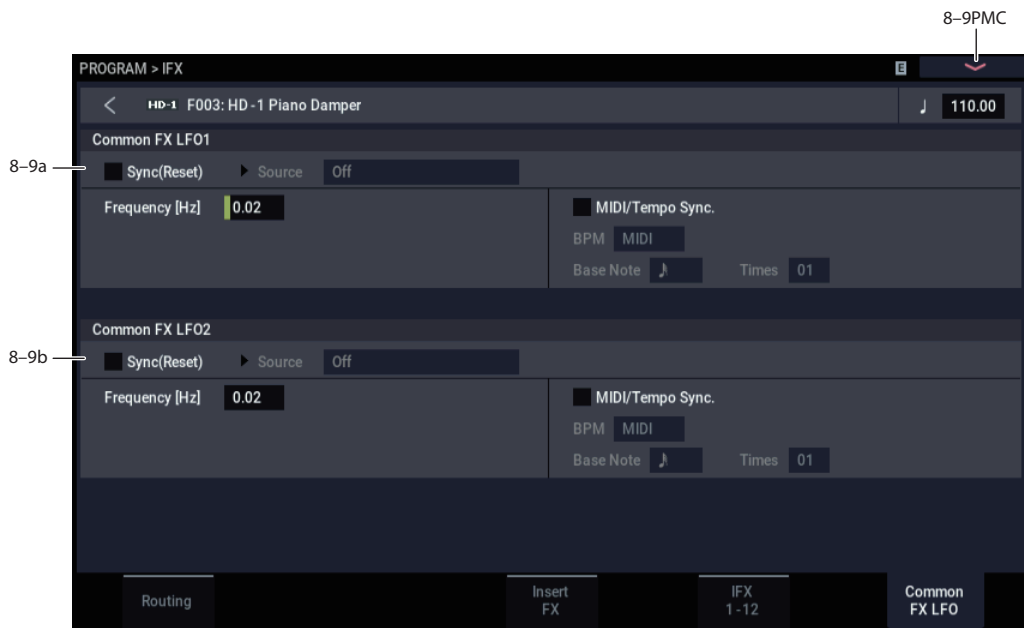

The two Common FX LFOs allow you to synchronize LFO-based modulation for multiple effects, such as phasers, flangers, filters, and so on.

The Common LFOs control only the frequency, MIDI synchronization, and reset options; each individual effect still has its own settings for the LFO waveform and phase.

Within the individual effects, you can choose whether to use one of the Common LFOs, or to use the individual effect's frequency, sync, and/or reset settings instead. This is done via the effect's **LFO Type** parameter; select **Individual** to use the effect's settings, or **Common 1** or **2** to use the Common LFOs.

MIDI Dmod (Dynamic Modulation) is controlled on the global MIDI channel specified in GLOBAL mode MIDI page.

8–9a: Common FX LFO1

Sync (Reset) [Off, On]

This specifies whether the Common FX LFO will be reset.

If this is on, operating the **Source** (below) will reset the phase of the LFO.

Source (Dmod Source) [List of Dmod Sources]

If “Sync (Reset)” is on, this selects the Dmod source that will reset the Common LFO. For a complete list of Dmod sources, see “Dynamic Modulation Source List” on page 912.

MIDI This will be off when the modulation source specified by **Source** has a value below 64, and on when the value is above 64. The LFO will be reset when this value rises from a level below 64 to a level higher than 64.

Frequency [0.02...20.00 Hz]

This specifies the frequency of the Common FX LFO. Higher values make the LFO faster.

MIDI/Tempo Sync [Off, On]

On (checked): The LFO will synchronize to the system tempo, as set by either the Tempo knob or MIDI Clock. The LFO speed will be controlled by the **Base Note** and **Times** parameters, below. All settings for **Frequency** and **Frequency Modulation** will be ignored.

Off (unchecked): The Frequency settings will determine the speed of the LFO, and the tempo settings will have no effect.

BPM [MIDI, 40.00...300.00]

Base Note [♪...♩]

This sets a basic rhythmic value for the LFO speed, relative to the system tempo. The values range from a 32nd note to a whole note, including triplets. It applies only when **MIDI/Tempo Sync** is **On**.

Times [01...32]

This multiplies the length of the **Base Note**. For instance, if the **Base Note** is set to a sixteenth note, and Times is set to 3, the LFO will cycle over a dotted eighth note.

8–9b: Common FX LFO2

The parameters are identical to those for Common FX LFO1, as described under “8–9a: Common FX LFO1” on page 105.

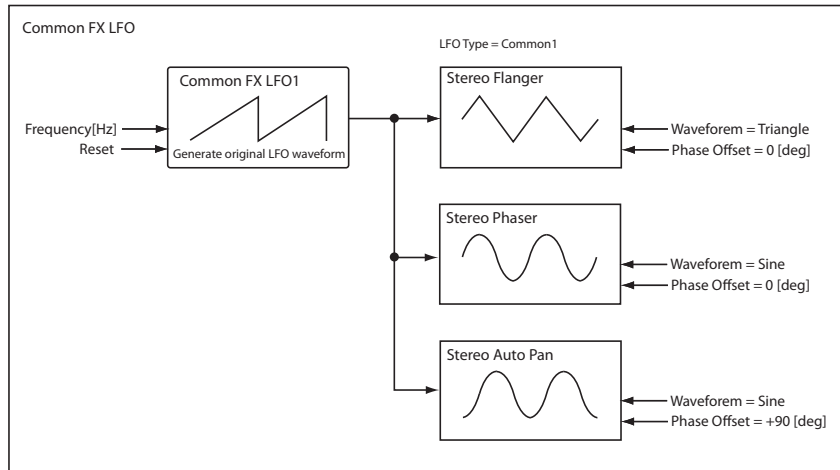

✓ 8-9: Page Menu Commands

- Compare →p.112
- Write Program →p.112
- Exclusive Solo →p.113
- Copy Insert Effect →p.122
- Swap Insert Effect →p.123

- PAGE →p.126
- MODE →p.126

PROGRAM > MFX/TFX

Here you can make settings for the master effects and total effects. For instance, you can:

- Route a sound to an master effects and total effects

- Make detailed settings for master effects and total effects

For more information, please see “Effect Guide” on page 731.

9-1: Routing

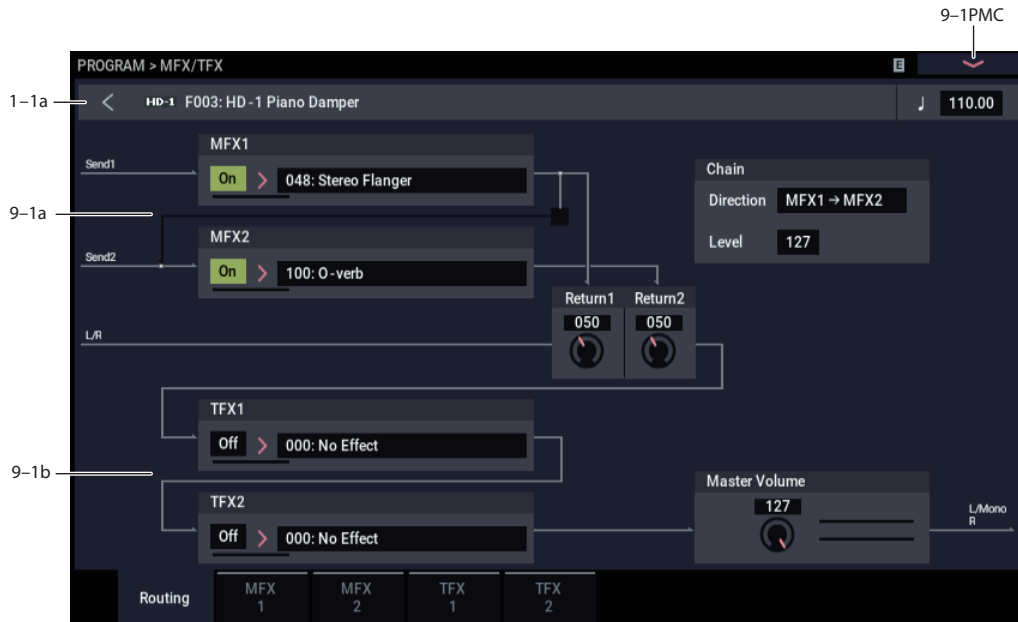

Here you can specify the type of master effects and total effects, and turn them on/off. The meters below the effects names display the effect output levels in realtime, showing the combined peak signals of the left and right channels.

The master effects are sent to the L/R bus. The total effects are inserted into the L/R bus.

9-1a: MFX1, 2

The master effect does not output the direct sound (Dry). Adjust the “Return 1” and “Return 2” return levels to return the signal to the L/R bus and mix it with the L/R bus signal.

The master effects are stereo-in/out, but depending on the selected effect type, the output may be monaural. See “In/Out” on page 739.

MFX1

MFX1 [000...197]

This selects the effect type for master effect 1. You can use any of the available effects, without limitation. If you choose 000:No Effect, the output from the master effect is muted.

The meter below the effect name displays the effect’s output level in realtime, showing the combined peak signals of the left and right channels.

Category/MFX Select menu

When you press the popup button, the Category/MFX Select menu will appear, letting you select effects by category. Use the tabs to select a category, and then select an effect within that category. Press the OK button to execute your selection, or press the Cancel button to cancel.

You can also use the Find button to search for effects by name. For more information, see “Find dialog” on page 7.

MFX1 On/Off [Off, On]

Switches the master effect 1 on/off. When off, the output will be muted. This will alternate between on and off each time it is pressed.

MIDI Separately from the settings here, you can use control change #94 to turn master effects 1 and 2 off. A value of 0 turns them off, and values of 1–127 restore the original setting. The global MIDI channel specified by **MIDI Channel** (GLOBAL 1–1a) is used for this message.

Return 1 [000...127]

This specifies the return level from the master effect to the L/R bus (after which it passes through TFX1 and 2, and is sent from L/MONO and R).

MFX2

MFX2 [000...197]

MFX2 On/Off [Off, On]

Return 2 [000...127]

These parameters specify the effect type for master effect 2, its on/off status, and the return level from master effect 2 to the L/R bus. See “MFX1” on page 107.

Chain:

Chain On/Off [Off, On]

On (checked): Chain (series connection) will be turned on for MFX1 and MFX2.

Category/MFX Select menu

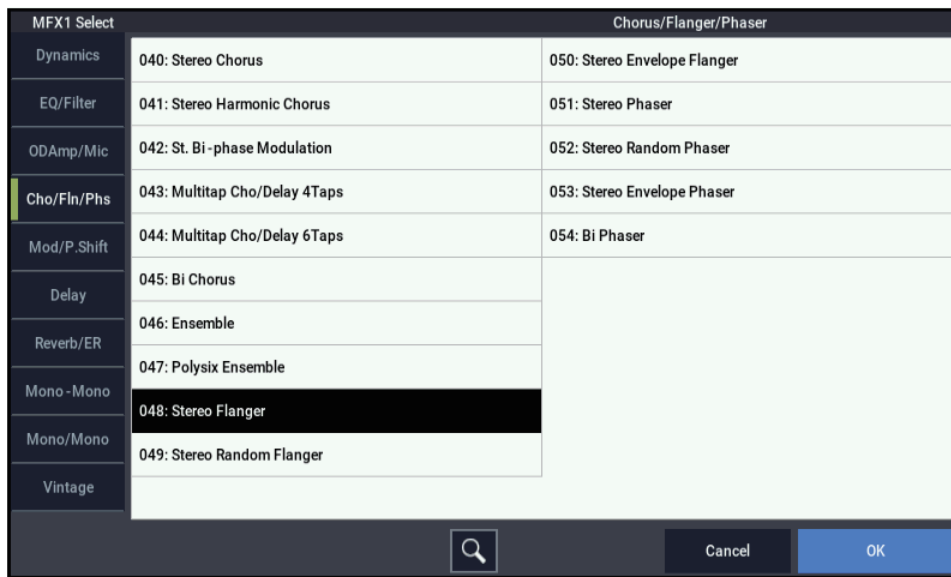

Chain Direction [MFX1->MFX2, MFX2->MFX1]

Specifies the direction of the connection when MFX1 and MFX2 are chained.

MFX1→MFX2: Connect from MFX1 to MFX2.

MFX2→MFX1: Connect from MFX2 to MFX1.

Chain Level [000...127]

When chain is On, this sets the level at which the sound is sent from the first master effect to the next master effect.

9-1b: TFX1, 2

These are the parameters for total effect 1 and 2, which are placed at the final stage of the L/R bus. After passing through the total effects, the sound is output to AUDIO OUTPUT (MAIN OUT) L/MONO and R.

For the total effects, the direct sound (Dry) is always stereo-in/out. The input/output configuration of the effect sound (Wet) will depend on the selected effect type.

The total effects are stereo-in and stereo-out, but the output may be monaural depending on the type of effect you select. (See “In/Out” on page 739.)

TFX1

TFX1 [000...197]

This selects the effect type for total effect 1. You can use any of the available effects, without limitation.

Category/TFX Select menu

When you press the popup button, the Category/TFX Select menu will appear, letting you choose effect types by category. Use the tabs to select an effect category, and then choose an effect within that category. Press the OK button to execute your choice, or press the Cancel button to cancel.

You can also use the Find button to search for effects by name. For more information, see “Find dialog” on page 7.

TFX1 On/Off [Off, On]

This turns total effect 1 on/off. If this is off, the input will be passed directly through. The setting will alternate between on/off each time you press this.

MIDI Separately from this setting, you can use control change #95 to turn both total effects off. A value of 0 turns them off, and values of 1–127 restore the original setting. The global MIDI channel specified by **MIDI Channel** (GLOBAL 1–1a) is used for this message.

TFX2

TFX2 [000...197]

TFX2 On/Off [Off, On]

These parameters specify the effect type and on/off status for total effect 2. See “TFX1” on page 108.

9-1c: Master Volume

Master Volume [000...127]

This controls the final volume level after total effects 1 and 2, as heard at AUDIO OUTPUT (MAIN OUT) L/MONO and R.

The stereo meter to the right of the volume control shows the audio levels at the main output in realtime, including clipping.

9-1: Page Menu Commands

- Compare →p.112
- Write Program →p.112
- Exclusive Solo →p.113
- Copy MFX/TFX →p.125
- Swap MFX/TFX →p.125
- PAGE →p.126
- MODE →p.126

9-2: MFX1

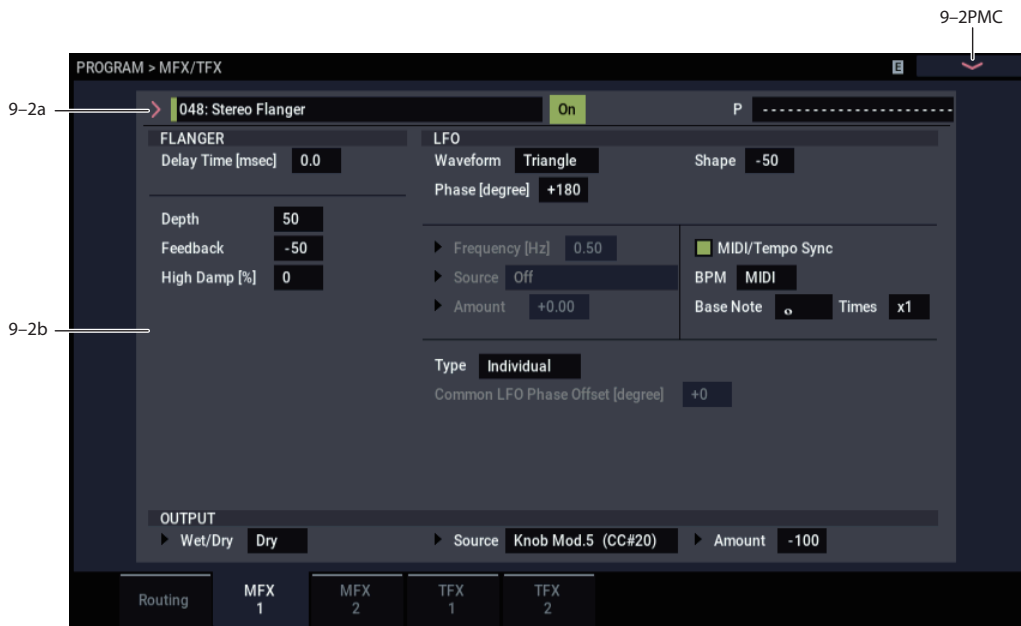

9-2a: MFX1

Here you can edit the parameters of the effect you choose for MFX1 in the MFX/TFX– Routing page.

MIDI Effect dynamic modulation (Dmod) is controlled on the global **MIDI Channel** (GLOBAL 1–1a). For more information, see “Dynamic Modulation Source List” on page 912.

MFX1 [000...197]

This selects the effect type for master effect 1.
→ p.107 “MFX1”

MFX1 On/Off [Off, On]

This turns master effect 1 on/off. It is linked with the on/off setting in the MFX/TFX– Routing page.

P (Effect Preset) [P00, P01...15, U00...15, -----]

This selects the effect preset.

For more information, please see “Effect preset function” on page 103.

9-2b: MFX1 Parameters

Here you can edit the parameters of the master effect.

For more information on using the master effects, please see “Master Effects (MFX1, 2)” on page 751.

✓ 9-2: Page Menu Commands

- Compare →p.112
- Write Program →p.112
- Exclusive Solo →p.113
- Copy MFX/TFX →p.125
- Swap MFX/TFX →p.125
- Write FX Preset →p.126
- PAGE →p.126
- MODE →p.126

9-3: MFX2

9-4: TFX1

9-5: TFX2

These pages let you edit the parameters of Master Effect 2 and Total Effects 1 and 2.

The parameters for MFX2, TFX1, and TFX2 are the same as for MFX1. For more information, see “9-2: MFX1” on page 109.

HD-1: Tone Adjust

Tone Adjust provides an elegant physical interface to the HD-1's parameters. Most of the factory sounds use the default layout, as shown below. You can also customize the layout for individual sounds, if desired.

HD-1 Tone Adjust Default Settings

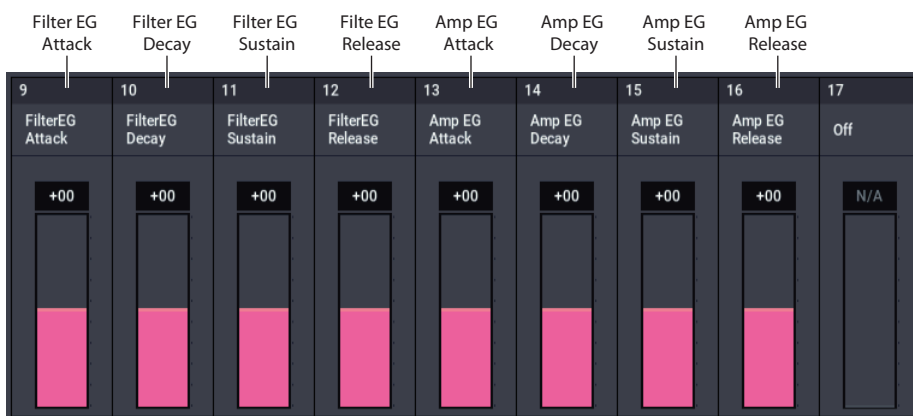
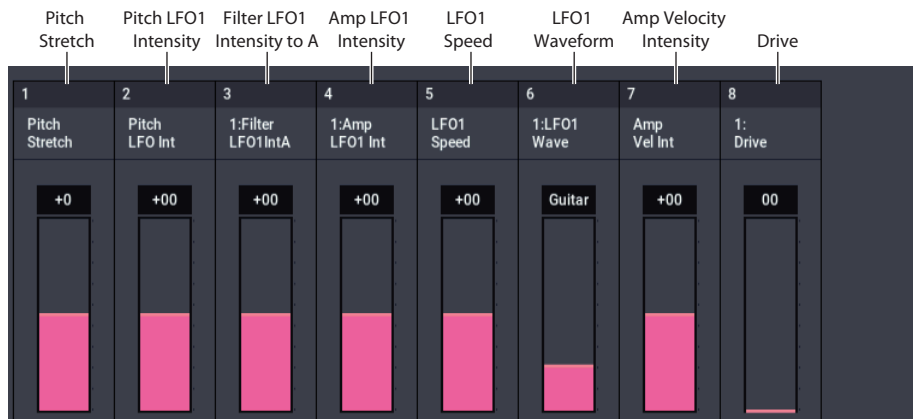
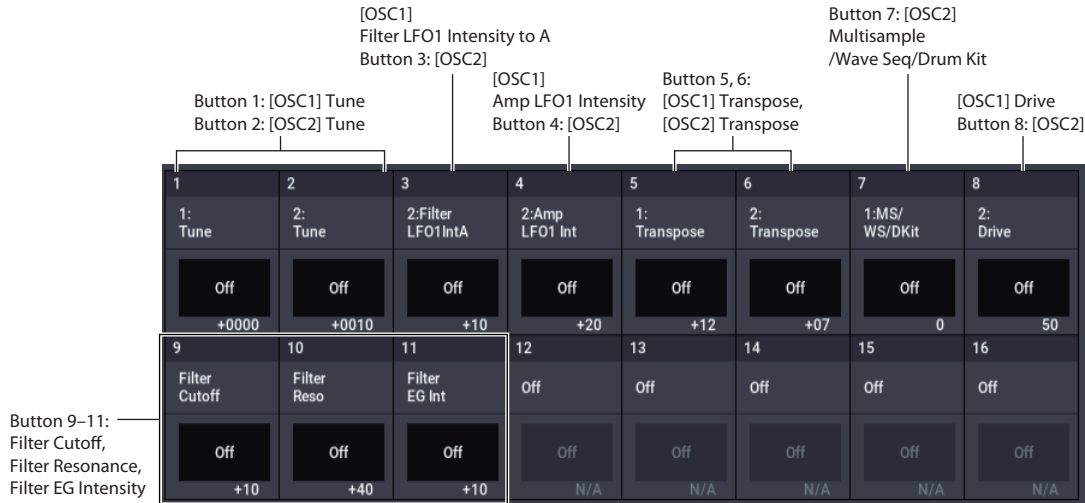

HD-1 Tone Adjust parameters

The HD-1 supports all of the Common Tone Adjust parameters, as described under “0-9a: Tone Adjust” on page 29.

PROGRAM: Page Menu Commands

| | |
|--|---------|
| Compare | →p. 112 |
| Write Program | →p. 112 |
| Exclusive Solo | →p. 113 |
| Show MS/WS/DKit Graphics | →p. 113 |
| Add To Set List | →p. 113 |
| Initialize Program | →p. 113 |
| Load required samples | →p. 114 |
| Optimize RAM | →p. 114 |
| Select Sample No. | →p. 115 |
| Select Directory/File for Sample To Disk | →p. 115 |
| Auto Sampling Setup | →p. 116 |
| Copy Tone Adjust | →p. 118 |
| Reset Tone Adjust | →p. 119 |
| Copy Oscillator | →p. 119 |
| Swap Oscillator | →p. 119 |
| Copy X-Y Envelope | →p. 119 |
| Sample Parameters | →p. 119 |
| Remap MS/Sample Banks | →p. 121 |
| Sync Both EGs | →p. 121 |
| Swap LFO 1&2 | →p. 121 |
| Copy External Scene | →p. 122 |
| Copy Scene | →p. 122 |
| Swap Scene | →p. 122 |
| Initialize Scene | →p. 122 |
| Copy Insert Effect | →p. 122 |
| Swap Insert Effect | →p. 123 |
| Insert IFX Slot | →p. 123 |
| Cut IFX Slot | →p. 124 |
| Clean Up IFX Routings | →p. 124 |
| Copy MFX/TFX | →p. 125 |
| Swap MFX/TFX | →p. 125 |
| Write FX Preset | →p. 126 |
| PAGE | →p. 126 |
| MODE | →p. 126 |

Compare

This command is available on all pages in PROGRAM mode.

Use this when you wish to compare the edits you have made to a Program or Combination's sound with the unedited original (i.e., the sound that is saved in memory). When you execute this command while editing a Program or Combination, the last saved settings for that Program or Combination number will be recalled. Use the Compare command once more to return the settings to how they were while you were editing them.

If the Compare command is not shown in the page menu commands, you cannot revert to the edited version of the settings.

Write Program

This command is available on every page in PROGRAM mode.

This command writes an edited Program into the NAUTILUS internal memory. It is available on every page in PROGRAM mode.

Write Program lets you:

- Save your edits
- Rename the Program
- Assign the Program to a Category
- Mark the Program as a Favorite
- Copy the Program to a different Bank and number

 Be sure to **Write** any Program that you wish to keep. An edited Program cannot be recovered if you do not write it before turning off the power or selecting another Program.

1. Select "Write Program" to open the dialog box.

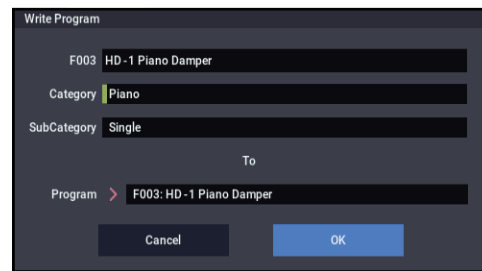

The upper line of the dialog shows the Bank, number, and Program name.

2. If you wish to modify the Program name, press the text edit button to move to the text edit dialog box, and enter the desired program name.

If a USB QWERTY keyboard (commercially available) is connected, you can use this to enter text instead of the on-screen keyboard. For more information, see "Editing names and entering text" on page 206 of the OG.

3. In Category and Sub Category, specify the category of the program that you are writing.

The category can be used to find this Program when selecting a program in PROGRAM, COMBINATION, or SEQUENCER modes.

Note: You can edit these category names in the GLOBAL Program Category page. For more information, see "3-1: Program Category" on page 665.

4. Press "To Program" to specify the destination Bank and number.

 **Important:** HD-1 Programs can only be written to HD-1 Banks, and EXi Programs can only be written to EXi Banks. For more information on the default Bank types, and on how to change them, please see "Program Bank Contents" on page 7, and "Changing the Program Bank Types" on page 3.

5. To Write the Program, press the OK button. To cancel, press the Cancel button.

 Do not turn off the power for at least 10 seconds after using the **Write Program** command. This allows the system time to complete the process, which includes saving a backup of the data to the internal drive.

Saving edits to GM Programs

You can edit GM Programs, but you must then save them to a Bank other than INT-G; the GM Programs themselves cannot be over-written.

Exclusive Solo

This command is available on every page in PROGRAM mode.

The function of the Solo button will switch each time you select “Exclusive Solo”.

The Solo function operates in two different ways, as shown below.

- **Cleared: Multiple Solo**
Solo is turned on for the OSC1 (EXi1), OSC2 (EXi2), the drum track and AUDIO IN. When the SW1 or SW2 button is set to switch SOLO on/off, Solo will be turned on or off with each press of the button.
- **Selected: Exclusive Solo**
Solo will be turned on for only one button.

Note: The solo operation settings for the SW1 or SW2 button are adjusted on the Controllers: Switch page in each mode.

Note: The Solo function will work on the following components in each mode. All of the components will be handled as a single group. When Solo is turned on for even one component when Exclusive Solo is on, the other components will turn off.

Program:

OSC1 (EXi1), OSC2 (EXi2), Drum Track, Audio Input1, Audio Input2, USB 1, USB 2

Combination:

Timbre1...Timbre16, Audio Input1, Audio Input2, USB 1, USB 2

Sequencer:

MIDI Track1...MIDI Track16,
Audio Track1...Audio Track16,
Audio Input1, Audio Input2, USB 1, USB 2

Sampling:

OSC, Audio Input1, Audio Input2, USB 1, USB 2

Show MS/WS/DKit Graphics

This works in conjunction with the PROGRAM > Basic page’s **Play Page MS/WS/DKit Display** parameters to control whether the PROGRAM > Home page shows the overview/jump parameters, or the selected graphics.

It only applies if a graphic has been selected for **Play Page MS/WS/DKit Display Osc 1** or **Osc 2**. If these parameters are instead set to Show MS/WS/DK Names, the menu command has no effect. For more information, see “1–1h: Play Page MS/WS/DKit Display” on page 40.

This mirrors the Global parameter “Show MS/WS/DKit Graphics” on page 635. Changes to the menu are reflected in the Global parameter, and vice-versa. To save this setting, use the Write Global Setting command in GLOBAL mode.

Add To Set List

This command, available on the Home pages of PROGRAM, COMBINATION, and SEQUENCER modes, allows the addition of the current Program, Combination, or Song to a Set List.

1. Choose “Add to Set List” to open the dialog box.

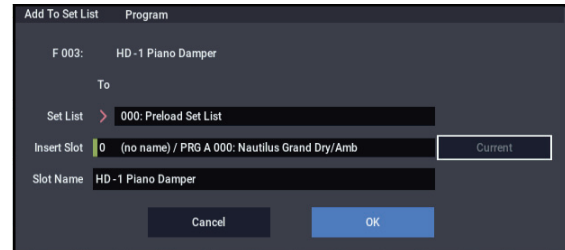

2. Use the “Set List” and “Insert Slot” parameters to select the destination Set List and Slot.

By default, these are set to the current Set List and Slot. If you select something other than the current Set List and Slot, the **Revert to Current** button will be enabled; press this button to return the parameters to the current Set List and Slot.

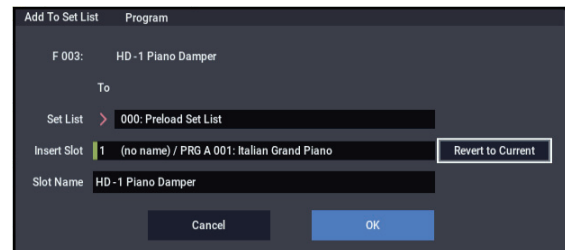

3. Use the text popup to set the Slot Name as desired.

The name of the Program, Combination, or Song is copied into the slot name by default.

4. Press **OK** to add the Program, Combination, or Song to the Set List, or press **Cancel** to exit without making changes.

When you press OK, the current Program, Combination, or Song is inserted at the selected Slot, using the same logic as the Set List Edit page’s Insert command.

When adding a Song, the current Keyboard Track is copied into the slot’s Keyboard Track parameter.

Initialize Program

Initialize Program is available on the PROGRAM > Home page. This command restores all Program settings to their defaults, so that you can start with a clean slate. Note that any edits you’ve made to the Program will be lost.

You can either initialize the current Program only, or all Programs in the current bank.

To initialize only the current Program:

1. Select the “Initialize Program” menu command.

The Initialize Program dialog box will appear.

By default, the **All Programs in the current bank** checkbox will be disabled (un-checked). Leave it that way.

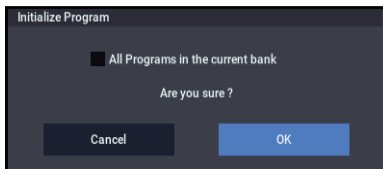

2. Press OK.

The Program’s edit buffer will be initialized, restored to default values. Note that in this case the stored data is not affected. If you want to keep the initialized Program, you’ll need to use the **Write** command.

To initialize all Programs in the current bank:

1. Select the “Initialize Program” menu command.

The Initialize Program dialog box will appear.

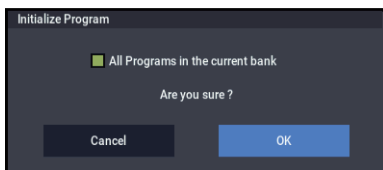

2. Enable the check-box for “All Programs in the current bank.”

3. Press OK.

All Programs in the bank will be initialized, including the stored version of the current Program.

Load required samples

This command appears only when the **Samples Not Loaded** message appears at the top of the display, indicating that the Program, Combination, or Song uses EXs, User Sample Bank, or SAMPLING mode data which is not currently loaded. It is available on the Home pages in PROGRAM, COMBINATION, and SEQUENCER modes.

Selecting **Load required samples** brings up a list of all of the missing Multisamples, Samples, and/or Drum Samples required by the Program, including the bank(s) containing the data. You can then load the sample data, if desired, and if there is room in memory to do so.

You can use the information at the bottom of the dialog box, including **Memory Required** and (Memory) **Available**, to determine whether or not you need to free up room for the new data. If there isn’t enough room, the **Load** button will be disabled.

To load the sample data:

1. Choose “Load required samples” to open the dialog box.

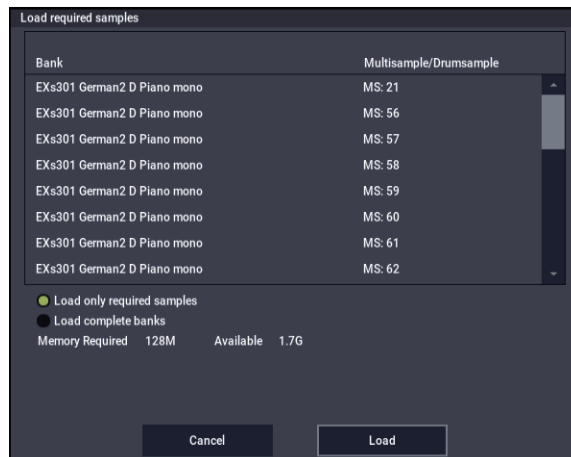

2. Select the “Load only required samples” radio button to load the listed data.

or:

Select the **Load complete banks** radio button to load the entire bank(s) containing the listed data.

3. Press Load to load the data, or Cancel to exit without loading.

If you switch between the radio buttons, the **Memory Required** and (Memory) **Available** displays will update as necessary.

Optimize RAM

Optimize RAM is available on the Audio In/Sampling tab of the Play page.

In some cases, especially if you’ve been loading and deleting different Samples and Multisamples, the internal memory can become fragmented.

“Fragmented” means that there are chunks of data scattered throughout the physical RAM, like toy blocks scattered across a floor. While the memory isn’t completely full, some of it can’t be used - just like it’s difficult to walk across a messy floor.

The **Optimize RAM** command cleans up the floor, so to speak. It collects all of the data into a single, continuous area of memory, so that the remaining free space can be used more efficiently.

If you run out of memory, try using this command; it may free up some extra space.

You can check the remaining amount of RAM in SAMPLING mode, on the main Recording page, under “Free Sample Memory/Locations.” For more information, please see “RAM” on page 579.

1. Select “Optimize RAM” to open the dialog box.

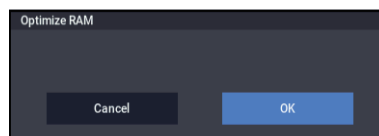

2. Press the OK button to execute the command, or press the Cancel button to cancel without executing.

Auto Optimize RAM

If **Auto Optimize RAM** is enabled, you don't need to use the **Optimize RAM** command; instead, RAM will be optimized automatically. For more information, see "Auto Optimize RAM" on page 635.

Select Sample No.

Select Sample No. is available on the Audio In/Sampling tab of the Play page, when the sampling **Save To** parameter is set to RAM.

This specifies the sample number into which the sampled data will be written. You can also specify whether the sample will automatically be converted to a program after sampling.

1. Choose Select Sample No. to open the dialog box.

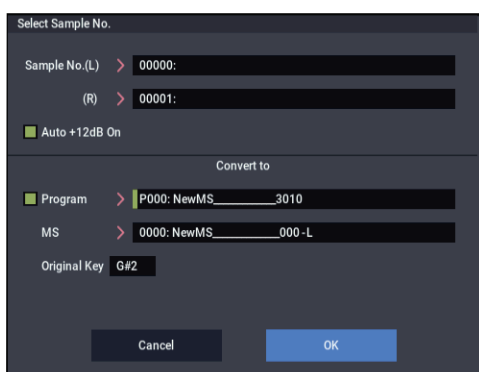

2. In "Sample No.," specify the writing-destination sample number.

By default, this will be the lowest-numbered vacant sample number. If you select "----:----No Assign----" or a sample number that already contains data, the data will automatically be sampled into the lowest vacant sample number. If you are sampling in stereo, "Mode" (0–8c), specify "Sample No.(L)" and "Sample No.(R)."

3. Set Auto +12dB On.

On (checked): +12dB will automatically be enabled for newly recorded samples. This is the default setting, and if **Recording Level** is set to 0.00 (dB), it means that resampled sounds will play back at the same volume as when they were recorded.

To set the optimum recording level and avoid clipping when you want to resample your playing in PROGRAM, COMBINATION or SEQUENCER mode, usually you will set the "Recording Level" to around "0.00 (dB)". Although the sample data that you resampled will record at the optimum level, the playback level will be lower than when it was resampled (when "+12dB" [SAMPLING 2–1d] is off). In this case, select the "Auto +12dB On" checkbox and resample the sound. The "+12dB" setting will automatically turn on, and the resulting playback level will be the same as when the sound was resampled.

The default settings in these mode when the power is turned on are "0.00 (dB)" for "Recording Level", with "Auto +12dB On" turned on. When you resample your playing in each mode while in this state, the sample will play back at the same level as when it was resampled. For more information, see "Setting levels" on page 27

The **Auto +12dB On** setting is made independently for PROGRAM, COMBINATION, SEQUENCER, and SAMPLING modes.

4. "Convert to" specifies whether the sample will automatically be converted into a program as soon as it has been sampled. This is convenient when you want to hear the sound immediately after sampling.

If you check the **Program** check box, the sample will automatically be converted into a program.

At the right, set **Program** and **MS** to specify the program number and multisample number for the converted program.

Set **Original Key** (SAMPLING 0–1b) to specify the location of the original key. The multisample will create an **Index** (SAMPLING 0–1b) with this key as the **Top Key** (SAMPLING 0–1b). The **Original Key** will increment by one after sampling, and the next higher note will be assigned the next time you sample.

5. Press the OK button to apply the settings you made, or press the Cancel button to return to the state prior to accessing this dialog box.

Select Directory/File for Sample To Disk

Select Directory/File for Sample To Disk is available on the Audio In/Sampling tab of the Play page, when the sampling **Save To** parameter is set to DISK.

When sampling to drive, this lets you set the drive, directory, and file name for the resulting WAVE file.

This dialog also lets you audition WAVE files directly from the drive; you can use this as a shortcut, instead of using the similar function in MEDIA mode.

Specifying the save destination for a WAVE file

1. Select the **Select Directory/File for Sample To Disk** command to open the dialog box.
2. Use the **popup button** located at the left of **Drive select** to select the writing-destination drive for sampling.
3. Use the **Open and Up** buttons to move to the desired directory.
4. In **Name**, specify a name for the WAVE file that will be written during sampling.

If you check **Take No.**, the file will be saved with a two-digit **Take No.** added to the end of the filename. This number will automatically increment each time you sample. This is convenient when you are sampling repeatedly, since each sample will be saved with its own filename.

5. Press the Done button to complete the settings.

Playing back a WAVE file

1. Select the **Select Directory/File for Sample To Disk** command to open the dialog box.
2. Use **Drive Select** and the **Open and Up** buttons to select the drive and directory, and select the **WAVE file (48 kHz)** that you want to play.
3. Press the **Play** button.

The selected WAVE file will be played.

Select Directory/File for Sample To Disk



4. Press the Stop button once again to stop playback.

If the WAVE file is mono, the same sound will be output to L/R.

Auto Sampling Setup

Auto Sampling Setup is available on the Audio In/Sampling tab of the Play page.

This command automatically configures the PROGRAM mode sampling-related parameters, making it easy for you to sample an external audio source or to resample your performance as you play a Program. You can also use this command to initialize the sampling settings.

After using Auto Sampling Setup, you can further adjust any of the settings to suit your needs as described in the “Note” paragraphs of each section.

⚠ When you execute this command, the applicable parameters will be set automatically. You cannot use the page menu command “Compare” to recall the previous settings.

1. Select Auto Sampling Setup to open the dialog box.
2. Press a radio button to select the type of settings you want to make.

Initialize: Initializes the sampling-related parameters to their default state.

Resample Program Play: Sets the sampling-related parameters to allow you to play a Program and resample your performance.

REC Audio Input: Sets the sampling-related parameters so that you can sample an external audio source. With these settings, you can play a Program while sampling, but only the external input will be recorded.

3. These settings will depend on the choice you make in step 2.

Initialize

If you selected Initialize:

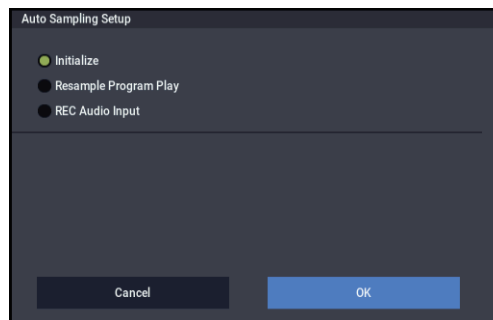

Press the OK button to execute the Initialize operation, or press the Cancel button if you decide not to execute. For more information, see “Automatically-set parameters and their values” on page 117.

Resample Program Play

If you selected Resample Program Play:

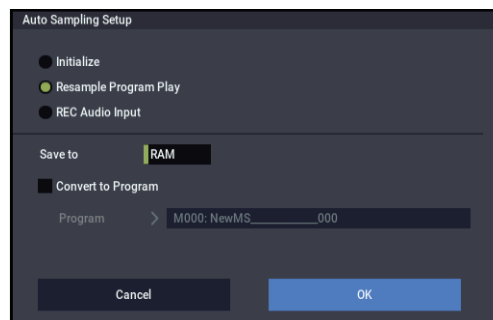

1. Use “Save to” to select either RAM or DISK as the destination to which the resampled data will be written.

If you choose RAM, the sampled data will be written into RAM for use in SAMPLING mode. If you choose DISK, the sampled data will be saved to drive as a WAVE file.

2. If Save to is set to RAM, you can also specify whether the sample will be automatically converted to a Program after resampling. If you want to convert the sample, check the “Convert to Program” option, and

use “Program” to specify the desired convert-destination program.

3. Press the OK button to execute Resample Program Play. If you decide not to execute, press the Cancel button. (See “Automatically-set parameters and their values” on page 118.)

Note a: Resample) To resample, execute Resample Program Play. Then press REC button and then START button, and play the program from the keyboard etc. Since “Trigger” (0–8c) is set to Note On, sampling will begin at the first note-on. When you’ve finished playing, press the STOP button to stop resampling.

Note b: Check the sampled data) Verify that your performance was resampled correctly. If you executed with “Save to” RAM and “Convert to Program” checked, select the program you specified as the convert-destination and play the C2 note of the keyboard to hear the sample. If you didn’t check “Convert to Program,” use SAMPLING mode to select the sample and listen to it.

If you selected “Save to: DISK,” use the page menu command **Select Directory/File for Sample To Disk** to hear the results.

Specify the writing destination

When saving the sample to drive, you can use the menu command **Select Directory/File for Sample To Disk** to specify the drive and folder to which the sample will be stored. For more information, please see “Select Directory/File for Sample To Disk” on page 115.

Note d: Sampling trigger) You can use the “Trigger” (0–8c) setting to change the way in which sampling will be started.

Note e: Sampling multiple sources simultaneously) If you want to simultaneously sample both an external audio source from AUDIO INPUT together with your own playing on a program, go to the Sampling page, and set the Input 1–2 setting “Bus (IFX/Indiv.) Select” to L/R, and the **Source Bus** to L/R.

Note f: If you execute Auto Sampling Setup with “Save to” RAM and the “Convert to Program” option checked, and you continue sampling, each successive sample will be automatically assigned to C2, C#2, D2, ... to create a multisample. A new multisample will be created the next time you execute **Auto Sampling Setup** and start sampling.

REC Audio Input

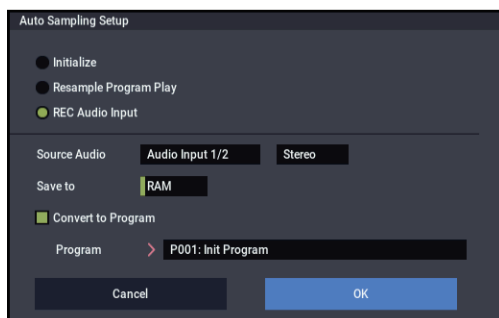

If you selected REC Audio Input:

1. Use “Source Audio” to select the external audio input source.

Audio Input 1/2: These are the analog audio inputs, for either microphones or line-level signals.

USB 1/2: These are the USB audio inputs, for sampling from a connected computer.

2. Use “L-Mono/R-Mono/Stereo” to specify whether the input source is mono or stereo.

L-Mono: Settings will be made to sample only the left input.

R-Mono: Settings will be made to sample only the right input

Stereo: Settings will be made for sampling in stereo.

3. Use “Save to” to specify the writing-destination for the sampled data. **RAM** will write the data into **SAMPLING** mode. **DISK** will create a **WAVE** file of the sampled data, and save it to drive.
4. With “Save to” set to **RAM**, you can optionally convert the sample to a Program. To do so, check “Convert to Program” and use the “Program” field to specify the destination bank and number.
5. If you want to apply an insert effect to the external audio input source while you sample, use “IFX” to select the insert effect you want to use. Turn this off if you don’t want to use an insert effect.

6. Press the OK button to execute REC Audio Input. If you decide not to execute, press the Cancel button.

See also “Automatically-set parameters and their values” on page 118.

Note: To sample, execute REC Audio Input, then press REC button, and then START button to begin sampling. (This is because “Trigger” is set to Sampling START button.) When you’re finished, press the STOP button to stop sampling.

If you want to sample while monitoring the performance generated by Arpeggiator, check “Latch” and start sampling while ARP is playing.

Sampling through an insert effect

To sample through an insert effect, do the following:

1. On the **Insert Effect - Insert FX** page, choose which effect you want to use.

2. Set the effect’s **REC Bus** to 1/2.

Using the REC Bus lets you sample directly from the effect’s output.

3. Go to the **Home– Sampling** page.

4. In the **Audio Input** section, make sure that **Use Global Setting** is not selected.

5. For the input(s) you’re sampling, set the **Bus Select** to the **IFX** you chose in step 1.

Now the input is routed through the selected effect.

6. In the **Sampling Setup** section, set **Source Bus** to **REC1/2**.

This is the counterpart to step 2, above: sampling will record from REC Bus 1/2, which in turn is carrying the direct output of the effect.

7. Adjust the effect parameters as desired, and then record your sample.

For additional information, refer to Note b) under “Resample Program Play” on page 116.

Automatically-set parameters and their values

| | | Initialize | Resample Program (Combination) Play | REC Audio Input |
|---|--------------------|---------------------|--|------------------------------------|
| Input (Input Source) ^{*1} | | Input1, 2, USB 1, 2 | Input1, 2, USB 1, 2 | [Source Audio] ^{*2} |
| Input 1, USB 1 | Bus Select | Off | Off | Off |
| | FX Ctrl Bus | Off | Off | Off |
| | REC Bus | Off | Off | 1/2 |
| | Send1/2 | 000 | 000 | 000 |
| | Pan | L000 | L000 | L000 |
| | Level | 127 | 127 | 127 |
| Input 2, USB 2, | Bus Select | Off | Off | Off |
| | FX Ctrl Bus | Off | Off | Off |
| | REC Bus | Off | Off | 1/2 |
| | Send1/2 | 000 | 000 | 000 |
| | Pan | R127 | R127 | R127 |
| | Level | 127 | 127 | 127 |
| Sampling Setup (Name) | Source Bus | L/R | L/R | REC1/2 |
| | Source Direct Solo | (N/A) | (N/A) | Off |
| | Trigger | Note On | Note On | Sampling START Button |
| | Metronome Precount | (N/A) | (N/A) | - |
| | Save to | RAM | [Save to] | [Save to] |
| | Mode | Stereo | Stereo | [Source Audio] ^{*3} |
| | Rec Level | +0.0 | +0.0 | +0.0 |
| Select Sample | Auto +12dB On | On | On ^{*4} | On ^{*4} |
| | Convert to Program | Off | [Convert to Program] ^{*5} | [Convert to Program] ^{*5} |
| | Program | - | [Program] ^{*5} | [Program] ^{*5} |
| | MS | - | (create new) ^{*5} | (create new) ^{*5} |
| | Original Key | - | (C2) ^{*5} | (C2) ^{*5} |
| Select Directory/File for Sample To Disk | - | - | - | - |

- : Not set automatically

[] : automatically set according to the settings of the parameter in the dialog box

*1 [] User Global Setting: Edit Program Parameters
[x] User Global Setting: Edit Global Parameters

*2 The input source specified in “Source Audio” will be set.

*3 If “Source Audio” is L-Mono this will be L-Mono, if R-Mono this will be R-Mono, and if Stereo this will be Stereo.

*4 When “Save to” RAM.

*5 When “Save to” RAM, and “Convert to Program” is checked.

Copy Tone Adjust

Copy Tone Adjust is available when CONTROL ASSIGN is set to **Tone Adjust**.

This command replaces the current Tone Adjust settings with those of any other Program, Combination Timbre, or Song Track.

1. Select “Copy Tone Adjust” to open the dialog box.

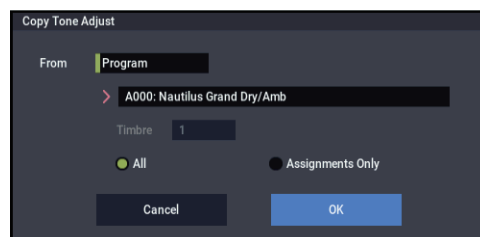

2. Use “From” to select the copy-source mode, bank, and number.

3. In the Timbre field (if you’ve selected a Combination) or Track field (if you’ve selected a Song), select the Timbre or Track to copy from.

4. Select either **All** or **Assignments Only** to specify the **Tone Adjust** parameters you want to copy.

All: Copies all of the Tone Adjust parameters and their values assigned to the switches and sliders.

Assignments Only: Copies only the parameters assigned to the switches and sliders. Values will not be copied.

5. Press the **OK** button to execute the **Copy Tone Adjust** command, or press the **Cancel** button if you decide to cancel.

Reset Tone Adjust

Reset Tone Adjust is available when **CONTROL ASSIGN** is set to **Tone Adjust**.

This command changes the Tone Adjust assignments, either resetting them to default values or turning them all off.

1. Select **“Reset Tone Adjust”** to open the dialog box.

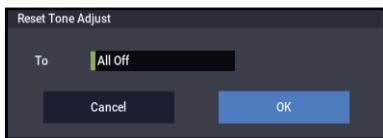

2. Use the **“To”** field to specify how the **Tone Adjust** assignments will be reset.

All Off: All assignments are turned off.

Default Setting: The assignments will be reset to their default settings for each program type (such as HD-1, AL-1, CX-3). For more information, see “HD-1: Tone Adjust” on page 111.

3. To execute the **Reset Tone Adjust** command, press the **OK** button. To exit without resetting the assignments, press the **Cancel** button.

Copy Oscillator

Copy Oscillator is available on all of the tabs under the Basic/X-Y, OSC/Pitch, Filter, Amp/EQ, and AMS Mix/Common Key Track pages.

This command is used to copy the settings from one oscillator to another.

1. Select **“Copy Oscillator”** to open the dialog box.

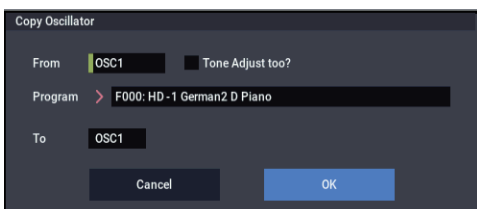

2. Use the **“From”** field to select the oscillator that you want to copy.
3. Use **“Program”** to select the bank and number of the copy-source program. You can press a **BANK SELECT** button to select the desired bank.

Note: If you’re editing an HD-1 Program, you can’t select EXi Programs, and vice-versa.

4. If you check **“Tone Adjust too,”** the **Tone Adjust** settings will temporarily be turned off, and from the copy-source **Tone Adjust** settings, the **Common**

portion and the assignments and current values of the corresponding **OSC** portion will be copied.

If **“Tone Adjust too”** is unchecked, the **Tone Adjust** settings will be maintained.

5. In **“To,”** specify the copy destination oscillator.
6. To execute the **Copy Oscillator** command, press the **OK** button. To cancel, press the **Cancel** button.

Swap Oscillator

Swap Oscillator is available on all of the tabs under the Basic/X-Y, OSC/Pitch, Filter, Amp/EQ, and AMS Mix/Common Key Track pages.

This command exchanges the settings of oscillators 1 and 2.

1. Select **“Swap Oscillator”** to open the dialog box.

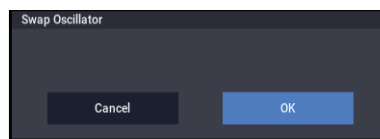

2. To execute the **Swap Oscillator** command, press the **OK** button. To cancel, press the **Cancel** button.

This can be selected only if **Oscillator Mode** (1–1a) is **Double**.

Copy X-Y Envelope

Copy X-Y Envelope is available on the X-Y Envelope tab of the Basic/X-Y/Controllers page.

This command copies X-Y envelope settings from the specified program, combination/timbre, or song.

1. Select **“Copy X-Y Envelope”** to open the dialog box.

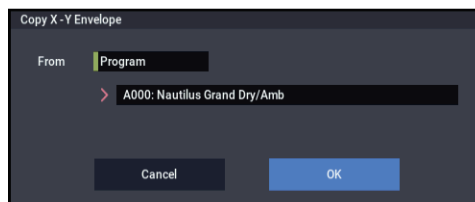

2. Use the **“From”** field to select the mode, bank, and number of the desired copy-source.

This command copies the parameters of the X-Y Envelope page of the corresponding mode.

Note: In order to replicate the way in which the relative volume of oscillators is controlled by the X-Y and X-Y envelope of the program selected for a combination timbre or a MIDI song track, turn on the **Enable Volume Control** check box in the X-Y Control page. To replicate the **CC** control effects, turn on the **Enable CC Control** check box in the X-Y **CC** page.

Use this command when you want to copy the **Position** or **Time/Tempo** of a X-Y envelope in order to create an envelope that produces the same movement.

3. Press the **OK** button to execute the command, or press the **Cancel** button to cancel.

Sample Parameters

Sample Parameters is available on the OSC 1/2 Basic pages.

This command lets you adjust basic timbral parameters for the individual Samples within a SAMPLING mode Multisample, including offsets for volume level, filter cutoff and resonance, pitch, EG attack and decay, drive and low boost, and EQ gain settings. (Technically, these apply to Indexes, which are key zones containing a single Sample and all of its associated parameters.)

These allow you to fine-tune the way that a Multisample plays across the keyboard. For instance, if one Sample is slightly soft, you can increase its volume level; if another is slightly too bright, you can lower its filter cutoff.

🔍 The Sample Parameters settings are stored in the Multisample, and not in the Program. After editing, make sure to save the Multisample data to internal drive.

🔍 These settings apply everywhere that the Multisample is used, and not just to the current Program. If another Program uses the same Multisample, it will also be affected by any changes that you make here.

To edit the **Sample Parameters**:

1. On the OSC 1/2 Basic pages, select a SAMPLING mode Multisample.

The **Sample Parameters** command is available only if you've selected a SAMPLING mode Multisample; it is not available for ROM, EXs, or User Sample Bank Multisamples, Wave Sequences, or Drum Kits.

2. Select the Sample Parameters menu command.

The **Sample Parameters** dialog will appear. Initially, the Index parameter will be selected, so you can control it via the keyboard:

3. Hold down the ENTER button, and play notes on the keyboard to select the Index you'd like to edit.

Selection from the keyboard works only when the Index parameter is selected.

4. Adjust the parameters as desired.

You can continue to play the Program while the dialog box is open.

🔍 If the Multisample you're editing is restricted to a specific velocity zone, you'll need to play within that zone in order to hear the results of your edits!

5. Repeat as necessary for other Indexes.

6. When you've finished editing, press the Done button.

Please note that Compare is not available for edits made in the **Sample Parameters** dialog.

7. To keep your edits, make sure to save the Multisample data in MEDIA mode.

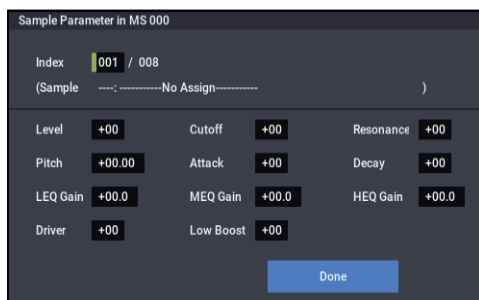

Index

[001...128]

An Index is a key zone in a Multisample, including a single Sample and all of its associated parameters. This is the currently selected Index.

The number following “/” is the total number of indexes in the current Multisample.

When this parameter is selected, you can select Indexes by using the keyboard:

1. **Select the Index parameter.**
2. **Hold down the ENTER key, and play single notes on the keyboard.**

As you play, the parameter will change to show the Index containing the last-played note.

Sample

[000]

This is the number and name of the Index's Sample.

Level

[-99...+00...+99]

This adjusts the volume of the Sample, relative to the Oscillator's settings. **Negative** (–) values will decrease the levels, and **positive** (+) values will increase the levels. A setting of +99 will double the volume. This is the same as the index **Level** parameter in SAMPLING mode; edits here will affect the values shown in SAMPLING mode, and vice-versa.

Each Sample also has a +12dB setting, as configured in SAMPLING mode; if this is on, the Sample will play back approximately 12dB louder. For more information, see “+12dB” on page 590.

Cutoff

[-99...+00...+99]

This adds to, or subtracts from, the Oscillator's filter cutoff settings. Note that the effect of this offset will change depending on the selected filter type (e.g. low-pass, high-pass etc.) and routing (e.g. single, 4-pole etc.).

Resonance

[-99...+00...+99]

This adds to, or subtracts from, the Oscillator's filter resonance settings.

Pitch

[-64.00...+00.00...+63.00]

This adjusts the playback pitch in one-cent steps. A setting of +12.00 raises the pitch one octave, and a setting of –12.00 lowers the pitch one octave. This is the same as the index **Pitch** parameter in SAMPLING mode; edits here will affect the values shown in SAMPLING mode, and vice-versa.

Attack

[-99...+00...+99]

This adds to, or subtracts from, the attack times of the filter EG and amp EG.

Decay

[-99...+00...+99]

This adds to, or subtracts from, the attack times of the filter EG and amp EG.

Driver

[-99...+00...+99]

This adds to, or subtracts from, the Oscillator's Driver setting. If the Driver circuit is bypassed, this will have no effect.

Low Boost

[-99...+00...+99]

This adds to, or subtracts from, the Oscillator's Low Boost setting. If the Driver circuit is bypassed, this will have no effect.

LEQ Gain [-36dB...+00...+36dB]

This adds to, or subtracts from, the Program's Low EQ gain setting. If the EQ is bypassed, this will have no effect.

MEQ Gain [-36dB...+00...+36dB]

This adds to, or subtracts from, the Program's Mid EQ gain setting. If the EQ is bypassed, this will have no effect.

HEQ Gain [-36dB...+00...+36dB]

This adds to, or subtracts from, the Program's High EQ gain setting. If the EQ is bypassed, this will have no effect.

Remap MS/Sample Banks

This command lets you change the Sample and Multisample bank settings in Programs, Drum Kits, and Wave Sequences, either for the entire system, a selected Program/Wave Sequence/Drum Kit bank, or for a single Program, Drum Kit, or Wave Sequence. For instance, you can remap Programs which use **Smp: Old RAM** to play from a **User Sample Bank** instead.

It is available on any pages containing a sample/multisample bank select combo box, including HD-1 P2 Osc/Pitch Osc1 and Osc2 Basic, MOD-7 and STR-1 PCM Osc pages, and the Wave Sequence, Drum Kit, and Global Sample Management pages.

To remap the Multisample and Sample Banks:

1. Select the Remap MS/Sample Bank command.

The Remap MS/Sample Bank dialog will appear.

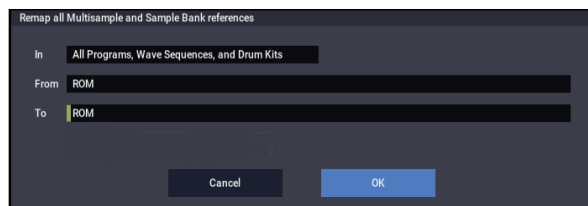

2. Set the In parameter as desired.

If all of the loaded sounds use just this one KSC, select **All Programs, Wave Sequences, and Drum Kits**.

If one entire bank uses just this KSC, but other banks use different KSCs, select the bank to remap: Bank A (Prog/Wseq/DKits)...Bank T (Prog/Wseq/DKits). This will remap all Programs, Wave Sequences, and Drum Kits in the selected bank.

If sounds within a single bank use multiple KSCs, select the **Current Program** option. For instance, some users keep all sample-related Programs in Bank USER-G, but Program 000 uses Friday.KSC, Program 001 uses Saturday.KSC, and so on. The **Current Program** option lets you deal with each Program individually. There are similar commands for individual Wave Sequences and Drum Kits; the correct option will appear for the current mode.

- 🔍 The Current Program option changes the edit buffer, and is not automatically saved. This lets you use COMPARE to revert to the original version, if desired. Make sure to Write the Program if you want to make the remap permanent. The All Programs etc. and Bank options changed the stored data directly, and do not require a separate Write command.

3. Set the From parameter to the old Multisample and/or Sample bank—the one you'll be changing to the new bank.

For instance, if you're updating sounds from **Smp: Old RAM** to a **User Sample Bank**, set From to **Smp: Old RAM**. Only Multisample/Sample banks which are currently loaded will appear in this list. If **In** is set to **Current**, only banks referred to by the current item will be shown.

4. Set the To parameter to the new Multisample and/or Sample bank—the one that remapped references will be changed to.

5. Press the OK button to complete the remapping, or press the Cancel button to exit without making changes.

If you press OK, a message appear to show how many bank references have been changed.

- 🔍 Remapping does not affect Tone Adjust settings, including any settings in Combinations or Songs.

Sync Both EGs

Sync Both EGs is available on the Filter 1/2 EG and Amp 1/2 EG pages.

This option allows you to edit the EGs of Oscillator 1 and Oscillator 2 together. When it is checked, editing the Filter EG of either Oscillator 1 or 2 will change both Filter EGs simultaneously. Similarly, editing the Amp EG of either Oscillator will change both Amp EGs.

This option is available only when the **Oscillator Mode** is set to **Double**.

1. Select "Sync Both EGs."

The LCD screen will indicate "Sync Both EGs," and the two EGs will be synchronized.

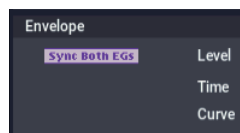

2. If you no longer want the EGs to be synchronized, select "Sync Both EGs" once again.

The indication will disappear from the LCD screen.

Swap LFO 1&2

Swap LFO 1 & 2 is available on all of the LFO pages, except for the Common LFO tab.

This command copies the settings of LFO1 to LFO2, and vice-versa.

Note: If LFO2 is being used to modulate LFO1, this command will erase that modulation routing (since the LFOs cannot modulate themselves).

1. Select "Swap LFO 1&2" to open the dialog box.

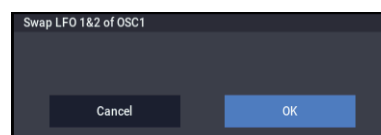

2. Press the OK button to execute the Copy or press the Cancel button if you decide to cancel.

Copy External Scene

This command copies the settings of the scene used by a specified program, combination, or song.

1. Select “Copy External Scene” to open the dialog box.

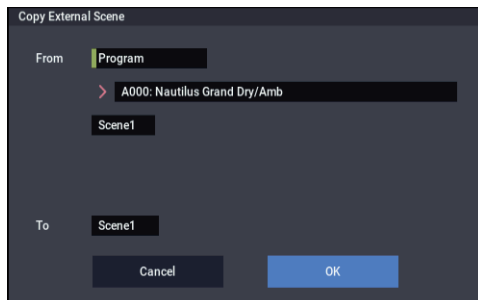

2. In “From,” select the copy source mode, bank, and number.
3. If you selected a combination or song as the copy-source, select the scene from which you want to copy.
4. In “To,” select the scene to which you want to copy.
5. Press the OK button to execute the Copy or press the Cancel button if you decide to cancel.

 The “Input Channel” and “Output Channel” (COMBINATION/SEQUENCER P7-1) settings of a combination or song are not copied.

Copy Scene

This command copies settings for the SCENE 1-4 buttons. You can use this command when you want to make settings for a scene based on the other scene settings you edited, or vice versa.

1. Choose “Copy Scene” to open the dialog box.

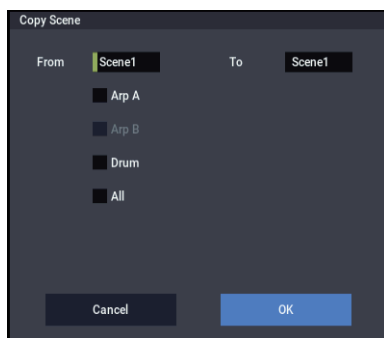

2. In “From” select the scene that you wish copy.
3. In “To” select the copy destination scene.
4. To execute the copy, press the OK button. To cancel without executing, press the Cancel button.

Swap Scene

This command swaps (exchanges) the settings of two SCENE 1-4 buttons.

1. Choose “Swap Scene” to open the dialog box.

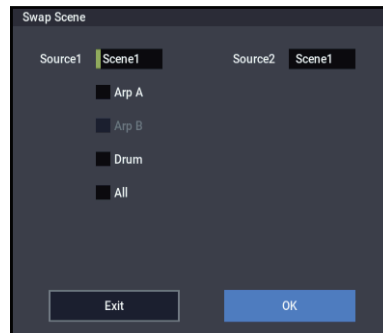

2. In “Source1” and “Source2”, select two ARP Scenes that you wish to swap.
3. To execute the swap, press the OK button. To cancel without executing, press the Cancel button.

Initialize Scene

This initializes the settings of a scene.

1. Select “Initialize Scene” to open the dialog box.

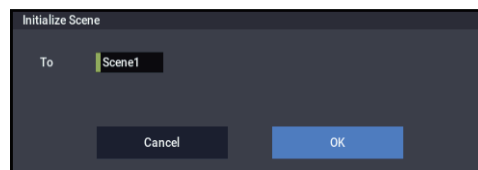

2. Select the scene you wish to initialize.
3. Press the OK button to initialize, or press the Cancel button if you decide not to initialize.

Copy Insert Effect

Copy Insert Effect is available on all of the IFX pages.

This command copies effects settings from within the current Program, from other Programs, Combinations, or Songs, or from the current SAMPLING mode settings.

1. Select “Copy Insert Effect” to open the dialog box.

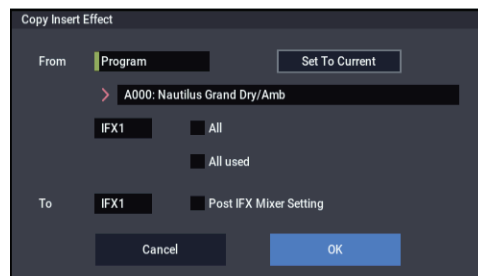

2. Select the mode, bank and number of the copy source in “From”.

When you press the “Set To Current” button, the currently selected mode, bank, number and IFX (edit cell) will automatically be assigned to “From”. This is useful when you want to temporarily copy an IFX that was already configured to an open effect slot, such as when you want to try out different effect settings.

3. Select the effect to copy. You can also copy from the master effect or the total effect.

All: All settings of the insert effect (the contents of the Insert FX page and the IFX1–12 effect parameters, excluding the “Ctrl Ch”) will be copied.

All used: Only the insert effects currently used will be copied from IFX1–12 of the copy source.

The copy source will be copied to consecutive open slots (from “000: No Effect”—note that the contents of the chain are not included), beginning with the insert effect set in “To.”

Note: The insert effect in the copy source that is set to “000: No Effect” will not be copied. However, it will be copied if “000: No Effect” is included in the chain. (Note that if the chain in the copy source contains only “000: No Effect”, the insert effect will not be copied.)

4. Select the insert effect in the copy destination.

Select the “Post IFX Mixer Setting” checkbox to simultaneously copy the settings after the signal passes through the insert effects in the copy source, namely “Pan (CC#8)”, “Bus Sel.”, “Ctrl Bus”, “REC Bus”, “Send1” and “Send2”. If this is left cleared, only the effect type and parameters will be copied.

5. Press the OK button to copy the insert effect, or press the Cancel button to quit.

 If you have copied from the master effect, the resulting effect will not be the same as the master effect, due to differences in routing and level settings in the master effect.

This command also provides an Auto Routing option that automatically adjusts related parameters in order to preserve the previously-existing routing.

This command is convenient when you want to add an effect within a chain of insert effects.

1. In the Insert FX page, select the IFX slot in front of which you want to insert an effect.

In this example, IFX1→IFX2→IFX3→IFX4→IFX5 are chained, and we are going to insert a slot in front of IFX3 so that we can add another IFX.

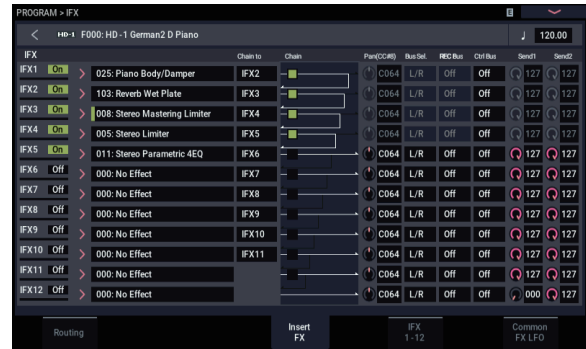

2. Select “Insert IFX Slot” to open the dialog box.

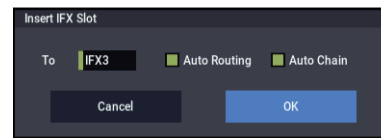

3. Use the “To” field to specify the IFX number at which you want to insert a slot. (The IFX you selected in step 1 or 2 will be shown here as the default.)

Specify the “Auto Routing” and “Auto Chain” options. Normally you will leave these on.

Auto Routing: This automatically adjusts the following parameters in order to preserve the currently-existing routing.

- Routing: Bus Select
- Routing- Page Menu: DKit Patch (Combi/SEQ)

 If Use DKit Setting on the Routing page is on for the program that used the drum kit, you may not be able to maintain the pre-insert routing without changing the Bus Select settings for the key of the drum kit, even when Auto Routing is selected.

Instead of using the Insert IFX Slot command in this case, try setting Chain to as desired, or try inserting an additional IFX slot using the Copy Insert Effect or Swap Insert Effect commands.

Auto Chain: on: If the IFX you’ve inserted is located within a chain, the Chain setting will automatically be turned on for the inserted IFX so that it will be chained with the preceding and following IFX.

If the IFX you’ve inserted is not inside a chain, Auto Chain does nothing.

4. Press the OK button to execute the Insert IFX Slot command, or press the Cancel button to cancel.

 If there are not enough IFX units to insert, pressing the OK button will simply exit the command without doing anything.

In this example, 000: No Effect will be inserted into IFX3 when you execute the command. The effects that were at

Swap Insert Effect

Swap Insert Effect is available on all of the IFX pages.

This command exchanges the effects, and their internal parameters, between two IFX slots.

All of the parameters shown on the IFX 1-12 pages will be copied.

Other IFX slot parameters will not be affected, including Pan, Sends 1 and 2, Chain, REC Bus, and FX Control Bus.

1. Select “Swap Insert Effect” to open the dialog box.

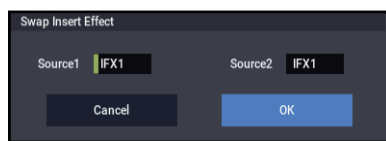

2. In “Source 1” and “Source 2,” select each of the insert effects that you wish to swap.

3. To execute the Swap Insert Effect command, press the OK button. To cancel, press the Cancel button.

Insert IFX Slot

Insert IFX Slot is available on the Routing and Insert FX tabs of the IFX page.

This command inserts an IFX slot.

Slots located after the inserted location will be relocated downward if a vacant slot exists. At this time, Chain, Pan (CC#8), REC Bus, FX Control Bus, Send 1/2, and Ctrl Ch (only for Combi and SEQ) will also be relocated.

IFX3–IFX5 will be relocated to IFX4–6, resulting in a chain consisting of IFX1–IFX6.



- For the newly inserted slot, turn the On/Off setting On. Then select and edit the desired effect.

Cut IFX Slot

Cut IFX Slot is available on the Routing and Insert FX tabs of the IFX page.

This cuts (removes) an IFX slot.

All slots that come after the slot that was cut will change positions by moving up. At this time, “Chain”, “Pan (CC#8)”, “REC Bus”, “FX Control Bus”, “Send1, 2” and “Ctrl Ch” (only Combi and SEQ) will move together. You can use the Auto Routing function to maintain the routing as it was before cutting. This automatically adjusts the related parameters.

This function is useful when cutting effects that you won't be using.

- In the Insert FX page, select the insert effect slot that you want to remove.

In this example, IFX1→IFX2→IFX3→IFX4→IFX5 are chained, and we are going to remove the IFX3 slot.

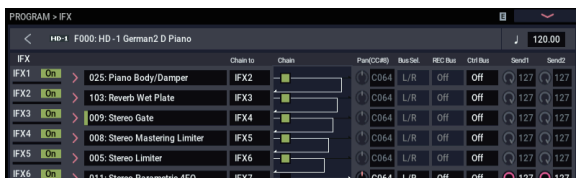

- Select “Cut IFX Slot” to open the dialog box.

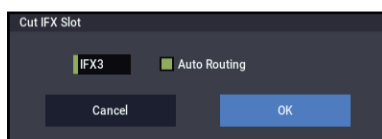

- Specify the number of the IFX you want to remove.

(The IFX you selected in step 1 or 2 will be shown here as the default.)

- Specify the “Auto Routing” option. Normally you will leave this on.

Auto Routing: This automatically adjusts the following parameters in order to preserve the currently-existing routing.

- Routing: Bus Select
- Routing- Page Menu: DKit Patch (Combi/SEQ)

- Press the OK button to execute the Cut IFX Slot command, or press the Cancel button to cancel.



Drum Kits not supported by Auto Routing

Drum Kits can store separate **Bus Select** settings for each key. Because these settings are stored in the Drum Kit, and not the Program, the **Auto Routing** option can't correct them.

Drum Kit Programs will use these separate **Bus Select** settings if the IFX Routing page's **Use DKit Setting** parameter is turned **On**.

In this case, you have two options. Either:

- Use **Auto Routing**, and then manually adjust the **Bus Select** settings for each key of the Drum Kit to match the new IFX slot arrangement.

or:

- Don't use the **Cut IFX Slot** command. Instead, remove the unwanted IFX slot by changing the **Chain to** settings, or by using the **Copy IFX** or **Swap IFX** commands.

Clean Up IFX Routings

Clean Up IFX Routings is available on the Insert FX and Track View tabs of the IFX page.

This command automatically rearranges unused IFX slots so that they are consecutive. It also rearranges effects in a discontinuous chain so that they are consecutive. Related parameters are automatically adjusted in order to preserve the existing routings.

If editing an IFX chain results in unused slots, or if the connections in a chain have become disorganized, you can execute this command to clean up the routing.

- Access the Insert FX page.

In this example, IFX1→IFX5→IFX11→IFX12 are chained, and the remaining slots are all vacant.

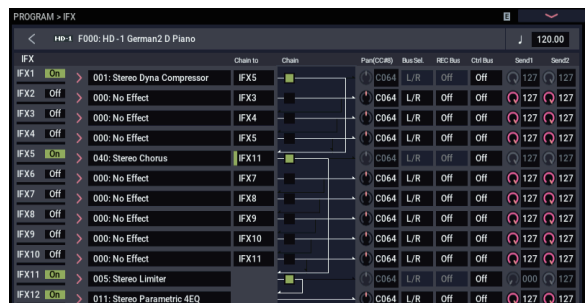

- Select “Clean Up IFX Routings” to open the dialog box.

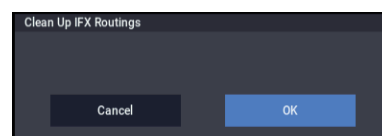

3. Press the OK button to execute the Clean Up IFX Routings command, or press the Cancel button if you decide to cancel.



In this example, the discontinuous chain IFX1→IFX5→IFX11→IFX12 has been reorganized into IFX1→IFX2→IFX3→IFX4, and the vacant slots (000: No Effect, unless located within a chain) have been rearranged consecutively.

At this time, the following parameters are automatically adjusted to maintain the existing routings.

- Routing: Bus Select
- Routing- Page Menu: DKit Patch (Combi/Seq)

 If the program uses a drum kit, and the Routing page “Use DKit Setting” is on, you may have to change the **Bus Select** setting for each key of the drum kit in order to reproduce the previous routing status.

In such cases, don’t use the “Clean Up IFX Routings” command. Instead, rearrange the IFX slots by making the appropriate **Chain to** settings or by using the “Copy Insert Effect” or “Swap Insert Effect” commands.

Copy MFX/TFX

Copy MFX/TFX is available on all of the MFX/TFX pages.

This command lets you copy any desired effect settings from Program, Combination, Song, or SAMPLING mode.

1. Select “Copy MFX/TFX” to open the dialog box.

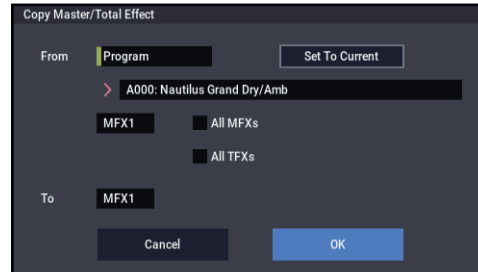

2. In “From,” select the copy source mode, bank, and number.

If you press the “Set To Current” button, the currently selected mode, bank, number, and MFX/TFX (edit cell) will automatically be assigned to the “From” field. This is useful when you’re trying out other effect settings and want to temporarily copy previously-edited MFX/TFX settings to another vacant effect slot.

3. Select the effect that you want to copy.

You can copy from an insert effect by selecting IFX1–12.

If you copy from an insert effect, the result may not be exactly the same, due to differences in routing and level settings.

If you select MFX1 or MFX2, the **Return** level will be copied at the same time.

You can copy settings from a total effect by selecting TFX1 or TFX2.

If you check **All MFXs**, all master effect settings will be copied.

If you check **All TFXs**, all total effect settings will be copied. Master Volume settings will not be copied.

4. In “To,” specify the copy destination master effects or total effects.

5. To execute the Copy Master/Total Effect command, press the OK button. To cancel, press the Cancel button.

Swap MFX/TFX

Swap MFX/TFX is available on all of the MFX/TFX pages.

This command swaps (exchanges) settings between MFX1, MFX2, TFX1, and TFX2.

1. Select “Swap MFX/TFX” to open the dialog box.

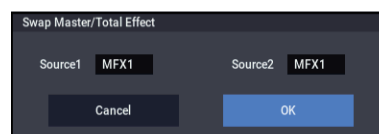

2. Use “Source 1” and “Source 2” to select the master effect(s) or total effect(s) that you want to swap.
3. To execute the Swap Master/Total Effect command, press the OK button. To cancel, press the Cancel button.

Write FX Preset

Write FX Preset is available on all of the effects parameter editing pages, including IFX 1-12, MFX 1 and 2, and TFX 1 and 2.

1. Select **“Write FX Preset”** to open the dialog box.

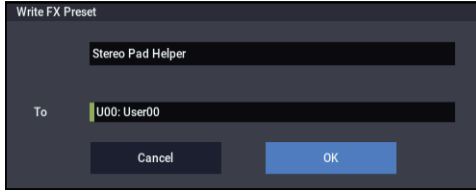

2. Press the text edit button to open the text edit dialog box, and enter a name for the effect preset.

If a USB QWERTY keyboard (commercially available) is connected, you can use this to enter text instead of the on-screen keyboard. For more information, see **“Editing names and entering text”** on page 206 of the OG.

3. Use the **“To”** field to select the writing destination. We recommend that you use U00–U15.
4. Press the **OK** button to write the user preset, or press the **Cancel** button if you decide to cancel.

Note: In MEDIA mode you can save or load effect preset settings on external media.

PAGE

Displays **“Page Select”**.

MODE

Displays **“Mode Select”**.

PROGRAM mode: EXi

EXi PROGRAM > Home

This is the main page of PROGRAM mode for EXi Programs. Among other things, you can:

- Select Programs
- Jump directly to the main editing pages
- Make edits Arpeggiator, Drum truck/Step sequencer to Scene
- Set up the audio input s and resampling options

EXi Common parameters

EXi, or Expansion Instruments, provide a wide variety of synthesis technologies. NAUTILUS includes eight EXi:

- AL-1 Analog Synthesizer
- CX-3 Tonewheel Organ
- STR-1 Plucked String.
- MS-20EX analog modeling synth
- PolysixEX analog modeling synth
- MOD-7 Waveshaping VPM synthesizer
- SGX-2 Premium Piano
- EP-1 MDS Electric Piano

You can combine any two EXi within an EXi Program.

To access the effects, arpeggiators, key tracking, common LFO, common step sequencers and other components used by all EXi programs, press the PAGE button to display the Page Select dialog box and then select the Home page. You can also press the Common tab and then press the button to the right of that tab to display each page and edit the parameters for each. Two EXis are selected from this Common tab. This section explains about EXi Common.

0-1: Overview

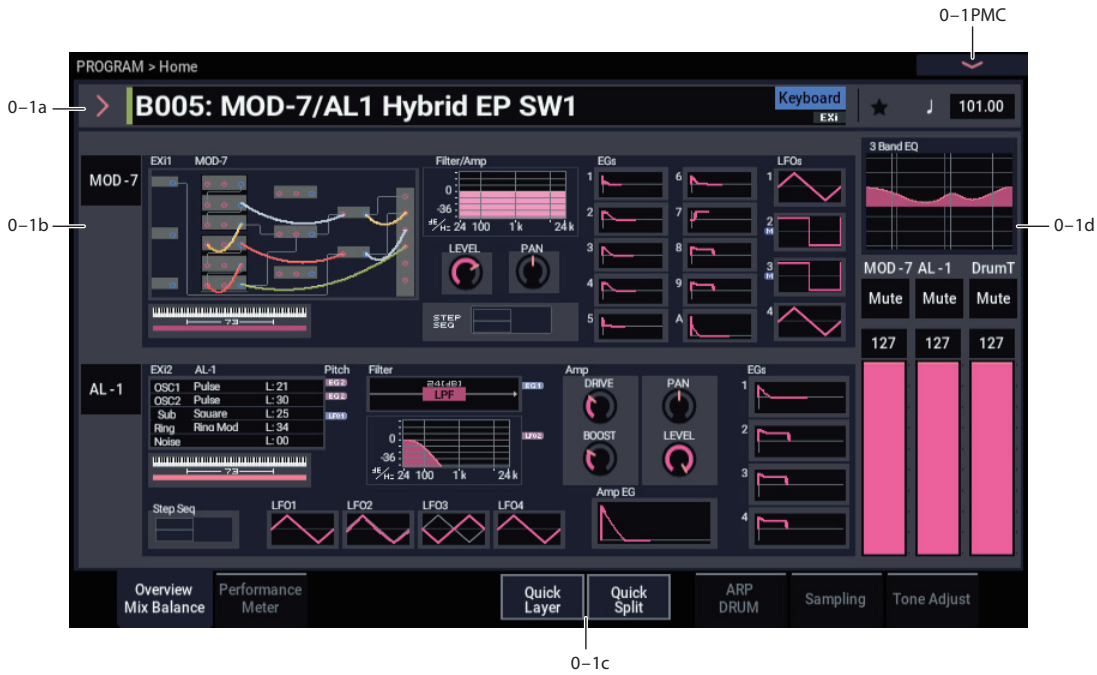

0-1a: Program Select

Bank (Bank Select) [A...T]

Bank Type [EX*i*]

EXi programs can be used by all banks except for GM. This setting is made in the “Set Program Bank Type” page menu command in GLOBAL mode.

Program Select [0...127]

Bank/Program Select

Category/Program Select

Favorite [Off, On]

♩ (Tempo) [040.00...300.00, EXT]

This is the same as with HD-1 programs. For more details, please see “0-1a: Program Select” on page 3.

0-1b: Overview and Page Jump

This section shows an overview of the most important settings for the Program’s two EXi instruments, along with some of the important Common parameters. The specific parameters will vary, depending on which EXi are being used. Parameters that you may see include oscillator settings, filter settings, EGs, LFOs, step sequencers, drawbar settings, and so on. See the individual EXi documentation for details.

The graphics give you a quick way to check all of these settings at a glance. They also let you jump instantly to any of the displayed parameters. Just touch one of the graphics, and you’ll jump to the page containing its parameters. For instance, if you touch the Filter EG graphic, you’ll go to the Filter EG page.

Tips: Press the EXIT button several times to return to this page.

0-1c: Quick Layer, Split

Quick Layer

Quick Split

Quick Layer and Quick Split let you automatically combine two Programs into a split or layered Combination.

These buttons open the Quick Layer and Quick Split dialogs, respectively. For detailed descriptions, see “Quick Layer” on page 8, and “Quick Split” on page 11.

0-1d: Common

3Band EQ Graphic

Mute (1) [On, Off]

Mute (2) [On, Off]

Mute (DrumT) [On, Off]

EXi1 Instrument Volume [000...127]

EXi2 Instrument Volume [000...127]

Drum Track Volume [000...127]

This is the same as with HD-1 programs. For more details, please see “0-1d: Common” on page 4.

✓ 0-1: Page Menu Commands

- Compare →p.112
 - Write Program →p.112
 - Exclusive Solo →p.113
 - Show MS/WS/DKit Graphics →p.113
 - Add To Set List →p.113
 - Initialize Program →p.113
 - Load required samples →p.114

 - PAGE →p.126
 - MODE →p.126
-

0-2: Performance Meter

This page lets you look at the real-time performance of the NAUTILUS, including voice usage, voice stealing, and effects.

This is the same as with HD-1 programs. For more information, see “0-2: Performance Meter” on page 13.

0-6: ARP DRUM

This page lets you make basic adjustments to Arpeggiator.

This is the same as with HD-1 programs. For more information, see “0-6: ARP DRUM” on page 15.

0-7: Sampling

This page lets you adjust the volume, pan, effects sends, and busing for the analog, USB, and audio inputs. It also controls the sampling-related settings for PROGRAM mode.

This is the same as with HD-1 programs. For more information, see “0-8: Sampling” on page 22.

0-8: Tone Adjust

Use the switches and sliders shown in the display to edit the program parameters.

This is the same as with HD-1 programs. For more information, see “0-9: Tone Adjust” on page 29.

EXi PROGRAM > Basic/X-Y/Controllers

These pages control the basic elements of the Program, along with the Vector synthesis features.

For instance, you can:

- Select the EXi instruments which form the basis of the Program's sound

- Set up X-Y CCs to modulate Program and Effects parameters
- Program the X-Y Envelope to move the X-Y position automatically

4-1: Program Basic

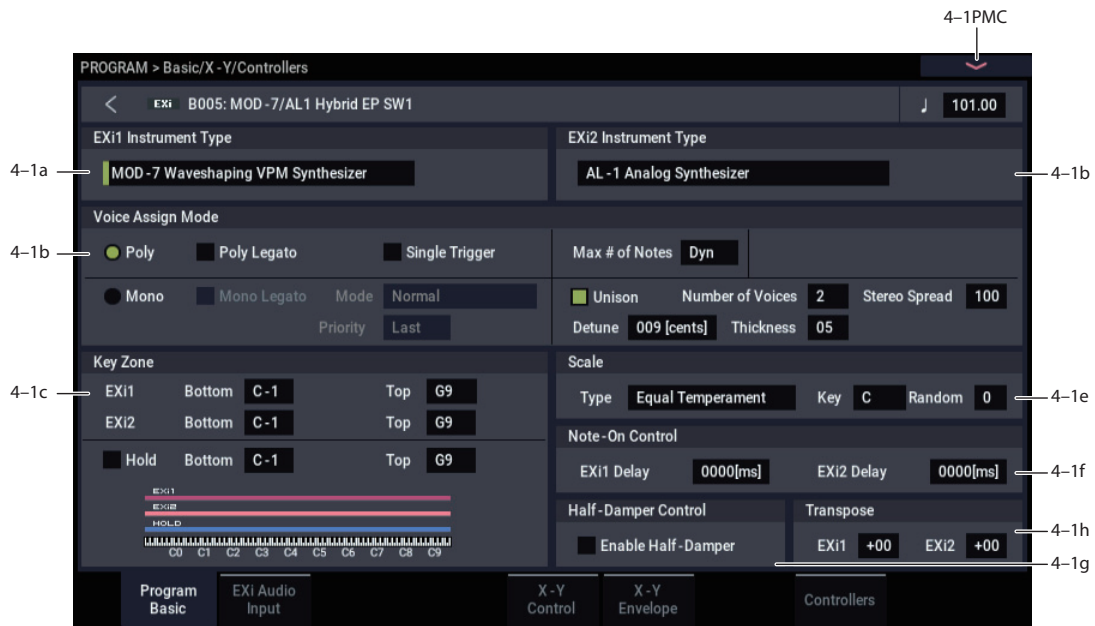

This page contains all of the basic settings for the Program. Among other things, you can:

- Select the EXi instruments which form the basis of the Program's sound
- Set the Program to play polyphonically or monophonically
- Create a keyboard split between EXi 1 and EXi 2
- Select the Program's scale

4-1a: EXi 1

EXi 1 Instrument Type [AL-1, CX-3, STR-1, MS-20EX, PolysixEX, MOD-7, SGX-2, EP-1]

This is the most basic setting for the EXi Program. EXi instruments are complete synthesizers, in and of themselves; they may create or process sounds in completely different ways, and allow you to adjust completely different parameters.

For instance, the AL-1 is a virtual analog synthesizer, the CX-3 is a physically modeled tone-wheel organ, the MOD-7 is a patch-panel based VPM, Waveshaping, and sample-mangling synthesizer, and so on.

You can select either one or two EXi's for the Program. Unlike HD-1 Programs, there is no setting for Single or Double. If there are two EXi's, it doesn't matter which EXi is in which slot. You can even select only a single EXi, but place it in the second slot.

4-1b: EXi 2

EXi 2 Instrument Type [List of EXi]

This is the second EXi slot for the Program.

4-1c: Voice Assign Mode

Voice Assign options may vary with different EXi

As much as possible, the different EXi instruments support all of the voice assign options. However, there are cases in which a particular EXi does not support a specific voice assign parameter.

Additionally, when a Program uses two different EXi instruments, some of the voice assign options will only take affect if they are supported by both EXi. These include:

- The main Mode selection (Poly or Mono)
- Poly Legato
- Single Trigger
- Mono Legato
- Mono mode (Normal or Use Legato Offset)
- Unison

(Voice Assign Mode) [Poly, Mono]

These radio buttons select the basic voice allocation mode. Depending on which mode you select, various other options will appear, such as **Poly Legato** (Poly mode only) and **Unison** (Mono mode only).

Poly: The program will play polyphonically, allowing you play chords.

Mono: The program will play monophonically, producing only one note at a time.

Poly

Poly Legato [Off, On]

Poly Legato is available when the **Voice Assign Mode** is set to **Poly**. This option applies only to EXi which include sample playback.

Legato means to play note so that they are smooth and connected; the next note is played before the last note is released. This is the opposite of playing detached.

On (checked): When you play with legato phrasing, only the first notes in the phrase (within the first 30ms) will use the normal Multisample Start Point, as set by the Start Point Offset parameter. The rest of the notes will use the Legato Start Point.

Off (unchecked): Notes will always use the setting of the Start Point Offset, regardless of whether you play legato or detached.

 With some Multisamples, Poly Legato may not have any effect.

Single Trigger [Off, On]

Single Trigger is available when the **Voice Assign Mode** is set to **Poly**.

On (checked): When you play the same note repeatedly, the previous note will be silenced before the next note is sounded, so that the two do not overlap.

Off (unchecked): When you play the same note repeatedly, the notes will overlap.

Mono

Mono Legato [Off, On]

This is available when the **Voice Assign Mode** is set to **Mono**.

Legato means to play note so that they are smooth and connected; the next note is played before the last note is released. This is the opposite of playing detached.

When Mono Legato is On, the first note in a legato phrase will sound normally, and then subsequent notes will have a smoother sound, for more gentle transitions between the notes.

The **Mode** parameter, below, switches between two different Mono Legato effects, each of which achieves this smoothness in a different way. See the description of that parameter for more details.

On (checked): When you play with legato phrasing, the notes within a legato phrase will sound smoother, according to the setting of the **Mode** parameter, below.

Off (unchecked): Legato phrasing will produce the same sound as detached playing.

Mode [Normal, Use Legato Offset]

This parameter is available only when **Mono Legato** is On.

Normal: When you play legato, the envelopes and LFOs (and samples, if the EXi supports samples) will not be reset. Instead, only the pitch of the oscillator will change. This setting is particularly effective for wind instruments and analog synth sounds.

 When used with EXi which support samples, the pitch may occasionally be incorrect, depending on which multisample you play, and where on the keyboard you play.

Use Legato Offset: This applies only to EXi which support samples. When you play legato, all but the first note will use the Multisample's Legato Start Point, instead of the one set by the Start Offset parameter. This will be most effective for Multisamples with specifically designed Legato Offset points; for some Multisamples, it may have no effect.

Envelopes and LFOs will still be reset, as they are with detached playing.

Priority [Low, High, Last]

Priority is available when the **Voice Assign Mode** is set to **Mono**.

This parameter determines what happens when more than one note is being held down.

Low: The lowest note will sound. Many vintage, monophonic analog synths work this way

High: The highest note will sound.

Last: The most recently played note will sound.

Max # of Notes

Max # of Notes [Dynamic, 1...16]

Dynamic is the default. With this setting, you can play as many notes as the system allows.

1-16 lets you limit the maximum number of notes played by the Program. You can use this to:

- Model the voice-leading of vintage synthesizers, such as the Polysix
- Control the resources required by individual Programs in COMBINATION and SEQUENCER modes

Max # of Notes applies only when the main **Voice Assign Mode** is set to **Poly**. If **Mono** is selected, this is grayed out.

This setting does not limit the **Unison Number of Voices** parameter. For instance, if **Max # of Notes** is set to **6**, and **Unison Number of Voices** is set to **3**, you can play up to 6 notes, each with 3 Unison voices.

If there are two EXi in the Program, the **Max # of Notes** applies equally to both. For instance, if **Max # of Notes** is set to **4**, you can play up to 4 notes on each EXi.

Unison

Unison [On, Off]

Unison can be used in both **Mono** and **Poly** modes.

On (checked): When Unison is on, the Program uses two or more stacked, detuned voices to create a thick sound.

Use the **Number of Voices** and **Detune** parameters to set the number of voices and amount of detuning, and the **Thickness** parameter to control the character of the detuning.

Off (unchecked): The Program plays normally. If **Unison** is **Off**, then all of its associated parameters are grayed out.

Number of Voices [2...16]

This controls the number of detuned voices that will be played for each note when using **Unison**. It applies only when **Unison** is **On**.

Stereo Spread [0...100]

Stereo Spread lets you create a wider stereo field when using **Unison**. It applies only when **Unison** is **On**.

This feature separates the different Unison voices into two groups. One group is panned to the left, and the other to the right. At **0**, both groups will be in the center; at **100**, the two groups will be hard-panned left and right, respectively; at intermediate values, they will be panned to intermediate left and right positions.

If there is an odd number of voices, one voice will be panned to the center.

If the voices are true stereo, **Stereo Spread** “steers” the stereo image of each voice. In this case, intermediate settings of **Stereo Spread** may be the most effective, since they will still preserve some of the original stereo image.

Unison detuning is spread as evenly as possible across the left and right channels. The lowest voice will be on the left, and the highest on the right; the next-lowest on the left, and the next-highest on the right, etc., as below:

- 14 cents: L
- +14 cents: R
- 10 cents: L
- +10 cents: R etc.

Depending on the **Thickness** setting, the detuning may lean slightly to one side.

Detune [00...200 cents]

Detune is available when **Unison** is **On**.

This parameter sets the tuning spread for the Unison voices, in cents (1/100 of a semitone). The **Thickness** parameter, below, controls how the voices are distributed across the detune amount. When **Thickness** is **Off**, the voices are distributed evenly, centered around the basic pitch.

For instance, let’s say that the **Number of voices** parameter is set to **3**, **Detune** is set to **24**, and **Thickness** is **Off**:

Voice one will be detuned down by 12 cents, voice two will not be detuned, and voice three will be detuned up by 12 cents.

| Voice | Detune |
|-------|--------|
| 1 | -12 |
| 2 | 0 |
| 3 | +12 |

As another example, let’s say that **Detune** is still set to **24** and **Thickness** is still **Off**, but **Number of voices** is set to **4**:

Voice one will still be detuned down by 12 cents, voice two will be detuned down by 4 cents, voice three will be detuned up by 4 cents, and voice 4 will be detuned up by 12 cents.

| Voice | Detune |
|-------|--------|
| 1 | -12 |
| 2 | -4 |
| 3 | +4 |
| 4 | +12 |

Thickness [Off, 01...09]

Thickness is available when **Unison** is **On**.

This parameter controls the character of the detuning for the unison voices.

Off: Unison voices will be evenly distributed across the Detune range, as shown above.

01-09: Unison voices will be detuned in an asymmetric way, increasing the complexity of the detune, and changing the way in which the different pitches beat against one another. This creates an effect similar to vintage analog synthesizers, in which oscillators were frequently slightly out of tune. Higher numbers increase the effect.

4-1d: Key Zone

You can create keyboard splits by setting top and bottom keys for EXi 1 and 2. Also, you can control the keyboard range over which the **Hold** parameter takes effect.

Setting Key Zones from the keyboard

In addition to using the standard data entry controls, you can also set all keyboard zones parameters directly from the keyboard. Just do the following:

1. Select the key zone parameter you’d like to edit.
2. Press and hold the **ENTER** button.
3. Play a note on the keyboard to set the parameter.
4. Release the **ENTER** button.

You can use this shortcut for all key and velocity parameters in the NAUTILUS.

EXi 1 Bottom [C-1...G9]

This sets the lowest key on which EXi 1 will play.

EXi 1 Top [C-1...G9]

This sets the highest key on which EXi 1 will play.

EXi 2 Bottom [C-1...G9]

This sets the lowest key on which EXi 2 will play.

EXi 2 Top [C-1...G9]

This sets the highest key on which EXi 2 will play.

Hold [On, Off]

Hold is like permanently pressing down on the sustain pedal. In other words, notes continue to sound as if you were holding down the key - even after you lift your fingers from the keyboard.

Unless the **Sustain Level** is set to **0** in Amp EG 1 (and Amp EG 2 in a Double Program), the sound will continue to play forever—or, for EXi which support samples, it will play for the entire length of the sample(s).

On (checked): The **Hold** function is enabled for the range set by the **Hold Bottom** and **Hold Top** parameters, below.

Off (unchecked): Notes will play normally. This is the default setting.

Hold Bottom [C-1...G9]

This sets the lowest key affected by the Hold function.

Hold Top [C-1...G9]

This sets the highest key affected by the Hold function.

4-1e: Scale

Type [Equal Temperament...User Octave Scale15]

Selects the basic scale for the Program.

Note that for many of the scales, the setting of the **Key** parameter, below, is very important.

For a complete list of the available scales, please see “1-1e: Scale” on page 38.

Key (Scale Key) [C...B]

Selects the key of the specified scale.

This setting does not apply to the **Equal Temperament**, **Stretch**, and **User All Notes** scales.

 If you're using a scale other than Equal Temperament, the combination of the selected scale and the **Key** setting may skew the tuning of the note. For example, A above middle C might become 442 Hz, instead of the normal 440 Hz. You can use the GLOBAL mode's **Master Tune** parameter to correct this, if necessary.

Random [0...7]

This parameter creates random variations in pitch for each note. At the default value of **0**, pitch will be completely stable; higher values create more randomization.

This parameter is handy for simulating instruments that have natural pitch instabilities, such as analog synths, tape-mechanism organs or acoustic instruments.

4-1f: Note-On Control

EXi 1 Delay [0ms...5000ms, KeyOff]

Use this to create a delay between the time that you press a key, and the time that EXi 1's note actually sounds.

This is most useful in Double Programs, for delaying one EXi in relation to the other.

KeyOff is a special setting. Instead of delaying the sound by a particular amount of time, the sound will play as soon as you release the key.

You can use this to create the “click” heard when a harpsichord note is released, for instance.

In general, when you use the **KeyOff** setting, it's also best to set the Amp EG **Sustain Level** to **0** (assuming the EXi includes an Amp EG).

EXi 2 Delay [0ms...5000ms, KeyOff]

This controls the note-on delay for EXi 2. For more information, see “EXi 1 Delay” on page 133.

4-1g: Half-Damper Control

A half-damper pedal is a special type of continuous foot pedal, such as the Korg DS-1H. In comparison to a standard footswitch, half-damper pedals offer more subtle control of sustain, which can be especially useful for piano sounds.

The NAUTILUS will automatically sense when a half-damper is connected to the rear-panel DAMPER input. For proper operation, you will also need to calibrate the pedal, using the Calibrate Half-Damper command in the Global page menu.

The off and full-on positions of the half-damper work just like a standard footswitch. In conjunction with the **Enable Half-Damper** parameter, below, intermediate positions allow a graduated control of sustain, similar to the damper pedal of an acoustic piano.

Enable Half-Damper [On, Off]

When this is **On** (checked), Half-Damper pedals, normal sustain pedals, and MIDI CC# 64 will all modulate the Amp EG, as described below.

When this is **Off** (un-checked), the pedals and MIDI CC#64 will still hold notes as usual, but will not modulate the Amp EG.

Note: When using the EP-1, Half-Damper functionality is always enabled, regardless of this parameter's setting.

Half-Damper Pedal and Release Time

The amount of modulation depends on whether the Amp EG **Sustain Level** is set to **0** (as is the case with most acoustic piano sounds), or set to **1** or more. The modulation is continuous, from 1x (no change) to 55 times longer; the table below shows a selection of representative points.

Half-Damper modulation of Amp EG Release Time

| CC#64 Value | Multiply Amp EG Release Time by... | |
|-------------|------------------------------------|------------------------|
| | If Sustain = 0 | If Sustain = 1 or more |
| 0 | 1x | 1x |
| 32 | 2.1x | 2.1x |
| 64 | 3.2x | 3.2x |
| 80 | 5.9x | |
| 96 | 22.3x | |
| 127 | 55x | |

With the SGX-2, this controls how the sounds switch when you press down on or release the damper pedal. On the EP-1, this controls the subtle nuances heard when releasing a note.

4-1h: Transpose

This transposes EXi 1 and EXi 2.

EXi 1 [-60...+60]

Adjusts the pitch of the EXi 1 in semitones, over a range of five octaves up or down.

EXi 2 [-60...+60]

Adjusts the pitch of the EXi 2 in semitones, over a range of five octaves up or down.

✓ 4-1: Page Menu Commands

- Compare →p.112
- Write Program →p.112
- Exclusive Solo →p.113
- Copy EXi Oscillator →p.140
- PAGE →p.126
- MODE →p.126

4-2: EXi Audio Input

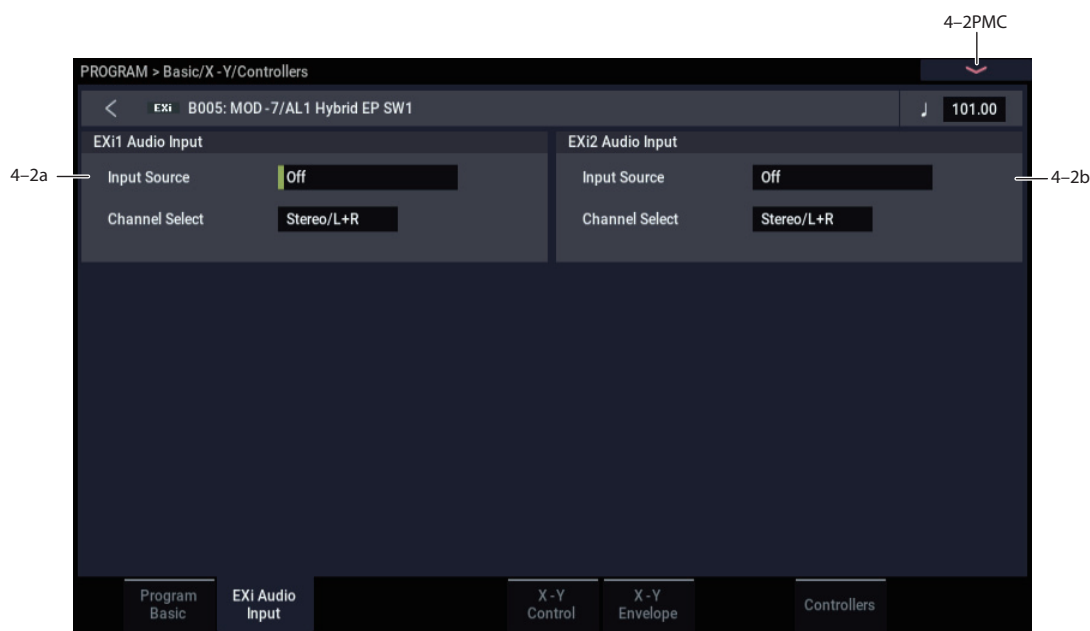

These parameters let you route audio into EXi instruments which support audio input, including the STR-1, MS-20EX, and MOD-7. You can use this to create feedback loops, or to process live or recorded audio through the EXi's synthesis engine.

EXi which do not support audio input will ignore these settings. The AL-1 supports audio input, but uses its own dedicated routing.

For more information on using audio inputs with EXi, see:

AL-1: “4-3c: Sub OSC/Audio Input” on page 149

STR-1: “4-8c: Feedback” on page 231

MS-20EX: “6-1k: EXTERNAL SIGNAL PROCESSOR (ESP)” on page 273

MOD-7: “5-1f: EXi Audio Input” on page 319

You can override these settings, if desired, in COMBINATION and SEQUENCER modes. For more information, see “2-6: EXi Audio Input” on page 412 (COMBINATION mode), and “2-6: EXi Audio Input” on page 487 (SEQUENCER mode).

4-2a: EXi 1

Input Source [PRG, Off, Audio Input 1/2, USB 1/2, L/R Output, Indiv. Output 1/2...3/4, REC 1/2...3/4, FX Control 1, 2, IFX 1...12, MFX 1, 2, TFX 1, 2]

This selects the input source for EXi1. You can use this to create a feedback loop, if desired.

Off disables the input.

Audio Input 1/2, and **USB 1/2** use the live audio from the selected input.

L/R Output and **Indiv. Output 1/2...3/4** use the audio as it is heard from the selected output (like connecting a cable from the output back to the input).

REC 1/2...3/4 and **FX Control 1, 2** use the audio from the selected bus.

IFX 1...12, **MFX 1, 2**, and **TFX 1, 2** use the output of the selected effect.

Channel Select [Stereo/L+R, Left, Right]

Stereo/L+R: This selection routes a stereo signal to EXi with stereo inputs, and an L+R summation to EXi with mono inputs.

Left, Right: This uses only a mono signal from the selected channel.

4-2b: EXi 2

EXi 2 has the same controls as EXi 1, above.

✓ 4-2: Page Menu Commands

- Compare →p.112
- Write Program →p.112
- Exclusive Solo →p.113
- Copy EXi Oscillator →p.140
- PAGE →p.126
- MODE →p.126

4-5: X-Y Control

Vector Synthesis lets you control Program and Effects parameters, by using the programmable X-Y Envelope, or by the combination of the two.

This is the same as with HD-1 programs. For more information, see “1-5: X-Y Control” on page 41.

✓ 4-5: Page Menu Commands

- Compare →p.112
- Write Program →p.112
- Exclusive Solo →p.113
- Copy EXi Oscillator →p.140
- PAGE →p.126
- MODE →p.126

4-6: X-Y Envelope

The X-Y Envelope works to control the X-Y position. It's also special because it's the only programmable modulation source which lets you modulate both Program and Effects parameters.

The X-Y Envelope is different from the other envelopes in several ways:

- Each point has two “levels” - one for the X axis, and one for the Y axis.
- The envelope times can be based on seconds and milliseconds, or synced to tempo.
- Each point has a hold time, as well as a transition time to the next point.
- The envelope can loop between two points, for either a specified number of repeats, or as long as you hold the note.

This is the same as with HD-1 programs. For more information, see “1-6: X-Y Envelope” on page 45.

✓ 4-6: Page Menu Commands

- Compare →p.112
- Write Program →p.112
- Exclusive Solo →p.113
- Copy EXi Oscillator →p.140
- Copy X-Y Envelope →p.119
- PAGE →p.126
- MODE →p.126

4-8: Controllers

This page lets you set up the functionality of SW1/2 and RT Control Knobs 1-6. This is set for each program.

This is the same as with HD-1 programs. For more information, see “1-8: Controllers” on page 48.

✓ 4-8: Page Menu Commands

- Compare →p.112
- Write Program →p.112
- Exclusive Solo →p.113
- Copy EXi Oscillator →p.140
- PAGE →p.126
- MODE →p.126

EXi PROGRAM > Modulation

The entire Program shares several modulation sources, including:

- A single Common LFO, shared by all the voices - similar to the global LFO on some vintage analog synths
- A single Common Step sequencer, shared by all the voices

- Two Common Key Tracking generators, which are set up for the entire Program, but then calculated individually for each voice

These pages let you set up these Program-wide modulation sources.

5-1: Common Step Seq AMSource

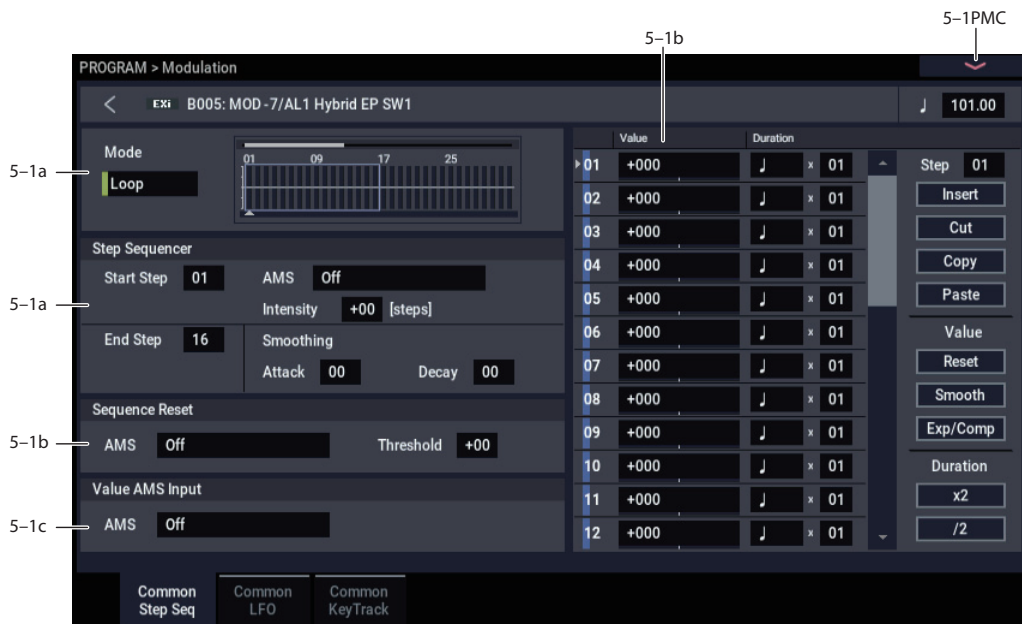

Overview

The Common Step Sequencer creates complex, rhythmic patterns, which can then be used as an AMS source. For instance, you can modulate a filter to create sample-and-hold effects, modulate pitch to create melodic patterns, or modulate amplitude to create pulsing, triggered-gate effects.

The sequence can have up to 32 steps, each with its own level and duration. It can loop, or play only once. You can also:

- Re-start the Step Sequencer via AMS
- Modulate the Start Step via AMS
- Use individual steps to either gate or do sample-and-hold on a continuous AMS source, such as an LFO
- Assign individual steps to create a random level
- Use Smoothing to create gentle, curving shapes

Differences from per-voice Step Sequencers

There is only a single Common Step Sequencer shared by the entire Program. It starts running as soon as you select the Program, and only resets when you tell it to do so explicitly via the **Sequencer Reset** parameter. This is different from the per-voice Step Sequencer's **Key Sync Off** setting, which resets whenever all notes are released.

(However, you can create a similar behavior, if you like; see the **Sequencer Reset** parameter for more information.)

The Common Step Sequencer's persistence can be handy if you want to create a constant rhythm, and then play "underneath" that rhythm without re-triggering it. For instance, you can use a MIDI controller in your sequencer to reset the Common Step Sequencer every few bars, regardless of what notes are being played.

Creating melodic patterns with the Step Sequencer

You can use the Step Sequencer to modulate synthesis parameters, such as filter cutoff— and you can also use it to create melodic patterns. To do so:

1. Assign the Step Sequencer as an AMS source for Pitch.
2. Set the AMS intensity to +25.
3. In the Step Sequencer, set the step values as desired. Each increment of 4 equals a semitone.

For example, to play an ascending chromatic scale, set the step values to 0, +4, +8, +12, +16, and so on. One octave up is +48, and two octaves up is +96.

5-1a: Step Sequencer

Mode [Loop, One Shot]

Loop makes the Step Sequence loop continuously between the **Start Step** and the **End Step**.

One Shot makes the Step Sequence play once from the **Start Step** to the **End Step**, and then hold at the **End Step**. You can still reset the Step Sequencer from AMS to make it play again.

Start Step [1...32]

This sets the step on which the sequence will start. The **Start Step** is important for the **Mode** parameter, above. You can also modulate it via AMS.

AMS [AMS Sources]

This selects an AMS source to modulate the **Start Step**. For a list of AMS sources, see “Alternate Modulation Source (AMS) List” on page 903.

Intensity [-32...+32]

This controls the depth and direction of the **Start Step** modulation.

End Step [01...32]

This sets the last step in the sequence. Once the sequence reaches the **End Step**, it will either hold there until the note goes away (if **Mode** is set to **One Shot**), or loop back to the **Start Step** (if **Mode** is set to **Loop**).

Smoothing

These controls filter the Step Sequencer’s output signal, creating more gentle transitions between values. You can use this to round off the hard edges of the Step Sequencer’s output, or to create envelope-like effects.

You have separate control of the amount of smoothing during the attack (when the signal is increasing) and decay (when it’s decreasing).

Attack [00...99]

This controls the attack time of the smoother, or how long it takes to reach a new, *higher* value.

Higher **Attack** settings mean longer times.

Depending on how quickly the Step Sequencer value is changing, high **Attack** settings may mean that a new value is never quite reached.

Decay [00...99]

This controls the decay time of the smoother, or how long it takes the smoother to reach a new, *lower* value.

Higher **Decay** settings mean longer times.

Using Smoothing to create envelope-like shapes

Since you have separate control over the attack and decay times, you can use Smoothing to create envelope-like pulses. To do so, you’ll need to alternate **Step Values** so that a positive value is followed by a value of zero. (You could use negative values, as well, but that would make the action of the **Attack** and **Decay** controls more complicated.)

To hear the effect clearly, let’s use an AL-1, and assign the Step Sequencer to modulate Filter Cutoff:

1. In a single EXi Program, set EXi1 to AL-1.

2. Set the Filter Type to Lowpass, and the Routing to 24dB (4-pole).

3. Set the Filter Cutoff to 00.

4. On the Filter Mod page, set Filter A’s AMS to Common Step Sequencer, and set the Intensity to 90.

You could also use the per-voice Step Sequencer, but for this example we’ll use the Common one.

5. In the Common Step Sequencer, set the End Step to 4.

6. Set the Mode to Loop.

7. Set Step 1’s Value to +100.

8. For both Step 2 and Step 4, set the Value to 0.

9. Set Step 3’s Value to +80.

10. Set the Durations of all four Steps to a 32nd-note.

11. Turn the \downarrow (Tempo) at about 120 bpm.

If the tempo is really fast, you’d need to use longer Step Durations.

12. Set the Smoothing Attack to 0.

13. Adjust the Smoothing Decay to 80.

Now, the Step Sequencer will create a series of 16th-note pulses, like simple envelopes. With the settings above, they “envelopes” will have an instant attack, and a moderate decay/release time.

For more space between the pulses, try this:

14. For both Step 2 and Step 4, set the Duration “x” (Multiply Base Note by...) to 3.

This creates a series of 8th-note pulses, with a longer time between each pulse.

15. Adjust the Decay between 0 and 99, and listen to the difference that it makes.

You can also create smoother, LFO-like effects. Try this:

16. Set the Decay to 80, and then vary the Attack time.

With longer Attack times, the pulses become softer in character.

Using Smoothing to make step transitions more gentle

Without smoothing, the Step Sequencer’s output has very sharp transitions between values. Often, this may be just what you’re looking for. In some cases, however, these transitions may cause audio artifacts, such as low-frequency bumps. This will depend on the parameter being modulated, and the intensity of the modulation.

If this happens, you can use smoothing to make the transitions more gentle, and reduce or eliminate the artifacts. To do so:

1. Adjust the smoothing until it’s just high enough that the artifacts are no longer heard. Start with the Decay, and then use Attack if necessary.

When using positive Step Sequencer values and positive modulation, you’ll generally only need to adjust the Decay; otherwise, you may need to adjust the Attack as well.

The trick is to set the smoothing high enough so that the artifacts go away, but low enough that the sound of the Step Sequencer isn’t altered significantly.

5-1b: Sequencer Reset

AMS [AMS Sources]

This selects an AMS source to reset the sequence to the **Start Step**.

To create an effect similar to the per-voice Step Sequencer's **Key Sync Off** setting, set this to **Gate 1+ Damper**, and set the **Threshold** (below) to 1 or greater.

Threshold [-99...+99]

This sets the AMS level which will make the Step Sequencer reset. Among other things, you can use this to adjust the exact point in an LFO's phase at which the sequencer will be reset, effectively controlling its "groove" against other rhythmic effects.

When the threshold is **positive**, the Step Sequencer triggers when passing through the threshold moving upwards. When the threshold is **negative**, the Step Sequencer triggers when passing through the threshold moving downwards.

Note: with some LFO shapes, and with faster LFO speeds, the LFO may not always reach the extreme values of +99 or -99. In this case, setting the **Threshold** to these values may cause inconsistent behavior, or may mean that the Step Sequencer doesn't reset at all. If this happens, reduce the **Threshold** until the Step Sequencer triggers consistently.

5-1c: Value AMS Input

AMS [AMS Sources]

This is the AMS source used for steps set to **AMS Input** or **AMS Input S/H**.

5-1d: Step Parameters

Each of the 32 steps has its own settings for Value and Duration.

Value 1-32 [-100...+100, Random, AMS Input, AMS Input S/H]

-100 through +100 generate specific levels, just as you'd expect.

Random yields a different, random value every time the step is played.

AMS Input uses the signal from the **Value AMS Input** source, above. This can change continuously over the duration of the step. For instance, if you used an LFO as the **Value AMS Input**, you'd hear the LFO move over the duration of the step.

AMS Input S/H grabs the level of the **Value AMS Input** source at the start of the step, and then maintains that single value for the duration of the step.

Duration (Base Note) 1-32 [♪...♩]

This sets the basic length of the step, relative to the system tempo. The values range from a 32nd note to a whole note, including triplets.

x (Multiply Base Note by...) 1-32 [01...32]

This multiplies the length of the Base Note. For instance, if the Base Note is set to a sixteenth note, and Times is set to 3, the step's duration will be a dotted eighth note.

Command buttons

Step

Step [01...32]

Selects the step that you want to edit.

Insert

Inserts the cut or copied step at the current step.

Cut

Cuts the current step. Subsequent steps will be moved forward. If desired, you can then paste or insert the cut step into another location.

Copy

Copies the current step. You can then paste or insert the copied step into another location.

Paste

Pastes the cut or copied step onto the current step, replacing it.

Value

Reset

Resets the "Value" of each step to 000.

Smooth

Automatically adjusts the "Value" of each step so that they are smoothly connected.

Exp/Comp

When you press the Exp/Comp button, the Step Sequence Value dialog box will appear. The value of each step will be expanded or compressed by the percentage (%) you specify.

Step Sequence Value dialog box



Expand/Compress [%] [0...100]

If this is at 100%, the current value of each step will be used without change. If you check "Keep Proportion," the % value will be limited so that the expansion/compression will maintain the relationships between the current step settings.

Duration

x2

This doubles the duration of the steps or the "x (Multiply Base Note by...)" value. For example, it would turn eighth notes into quarter notes, and quarter notes into half notes.

/2

This halves the duration of the steps or the "x (Multiply Base Note by...)" value. For example, it would turn quarter notes into eighth notes, and eighth notes into sixteenth notes.

✓ 5-1: Page Menu Commands

- Compare →p.112
- Write Program →p.112
- Exclusive Solo →p.113
- Copy Step Sequencer →p.140
- PAGE →p.126
- MODE →p.126

5-2: Common LFO AMSource

This is a single, free-running LFO, global for all voices in the Program—like the modulation LFOs in some vintage analog synths. It's always available as a modulation source for both EXi1 and EXi2, regardless of which EXi instruments are being used.

This is the same as with HD-1 programs. For more information, see “5-9: Common LFO” on page 87.

5-3: Common Keyboard Track

The Program includes two Common keyboard tracking generators, in addition to any keyboard tracking within the individual EXi instruments. You can use these Common keytracks as AMS sources for modulating most AMS destinations.

The Common Key Track parameters are shared by the entire Program, but the actual AMS values are calculated individually for each voice.

This is the same as with HD-1 programs. For more information, see “6-9: Common KeyTrack” on page 96.

EXi PROGRAM > EQ

This page is very simple, but very useful: it lets you control the Program's EQ settings. This is the same as with HD-1 programs. For more information, see “4-9: EQ” on page 82.

EXi PROGRAM > IFX

This pages let you control the Program's twelve Insert Effects (IFX). This is the same as with HD-1 programs. For more information, see “PROGRAM > IFX” on page 98.

EXi PROGRAM > MFX/TFX

This pages let you control the Program's two Master Effects (MFX) and two Total Effects (TFX). This is the same as with HD-1 programs. For more information, see “PROGRAM > MFX/TFX” on page 107.

EXi PROGRAM: Page Menu Commands

| | |
|--|--------|
| Compare | →p.112 |
| Write Program | →p.112 |
| Exclusive Solo | →p.113 |
| Show MS/WS/DKit Graphics | →p.113 |
| Add To Set List | →p.113 |
| Initialize Program | →p.113 |
| Load required samples | →p.114 |
| Optimize RAM | →p.114 |
| Select Sample No. | →p.115 |
| Select Directory/File for Sample To Disk | →p.115 |
| Auto Sampling Setup | →p.116 |
| Copy Tone Adjust | →p.118 |
| Reset Tone Adjust | →p.119 |
| Copy EXi Oscillator | →p.140 |
| Copy X-Y Envelope | →p.119 |
| Copy Step Sequencer | →p.140 |
| Copy External Scene | →p.122 |
| Copy Scene | →p.122 |
| Swap Scene | →p.122 |
| Initialize Scene | →p.122 |
| Copy Insert Effect | →p.122 |
| Swap Insert Effect | →p.123 |
| Insert IFX Slot | →p.123 |
| Cut IFX Slot | →p.124 |
| Clean Up IFX Routings | →p.124 |
| Copy MFX/TFX | →p.125 |
| Swap MFX/TFX | →p.125 |
| Write FX Preset | →p.126 |
| PAGE | →p.126 |
| MODE | →p.126 |

Copy EXi Oscillator

This command copies the oscillator settings of a EXi program.

1. Select “Copy EXi Oscillator” to open the dialog box.

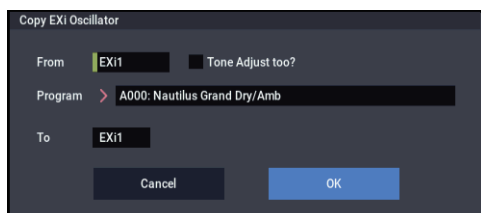

2. Use the “From” field to select whether to copy from EXi 1 or EXi 2.
3. Use the “Program” field to select the bank and number of the source Program.

Note: You can’t select HD-1 Programs here.

If “Tone Adjust too” is checked, the Tone Adjust settings will be copied along with the rest of the EXi parameters.

If this is not checked, and the destination (To) had previously used the same EXi Instrument Type as the source (From), then the Tone Adjust settings of the destination will be preserved.

If the EXi Instrument Types were different, all Tone Adjust settings of the destination will be initialized.

4. Use the “To” field to select the copy-destination oscillator.
5. Press the OK button to execute the Copy Oscillator operation, or press the Cancel button if you decide not to execute.

Copy Step Sequencer

This command copies the step sequencer settings of the desired EXi program.

1. Select “Copy Step Sequencer” to open the dialog box.

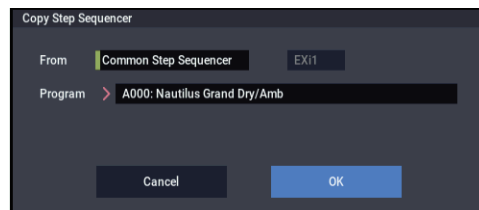

2. Use the “From” field to select either Common Step Sequencer or Voice Step Sequencer as the step sequencer you want to copy.

Voice Step Sequencer lets you copy from the per-voice step sequencer within an EXi, such as the AL-1. You can choose to copy from either EXi 1 or EXi 2. Some EXi, such as the CX-3, don’t have a per-voice step sequencer. Only EXi which actually contain per-voice step sequencers will appear in the EXi 1/2 selection.

3. Use the “Program” field to select the bank and number of the copy-source program.

Note: You can’t select HD-1 programs.

4. Press the OK button to execute the Copy Step Sequencer command, or press the Cancel button if you decide not to execute.

Some AMS settings are not copied

The following AMS-related parameters are not copied:

- Start Step AMS and Intensity
- Sequence Reset AMS and Threshold
- Value AMS Input AMS selection

EXi: AL-1 Analog Synthesizer

AL-1 Overview

The AL-1 is Korg's most full-featured virtual analog synthesizer to date. It's played from within EXi Programs, so you can layer it with any other EXi—or layer two AL-1s together. Its features include:

- Two ultra-low-aliasing oscillators, based on new, proprietary technology
- Sub oscillator, colored noise generator, and live audio input; FM, sync, and ring modulation
- Dual multi-mode resonant filters, including Korg's new Multi Filter
- Drive and Low Boost, for adding per-voice grit, girth and distortion
- Four per-voice LFOs, five re-triggerable envelopes, and a per-voice step sequencer

- Two key tracking generators and two AMS mixers
- Up to 80 voices of polyphony
- Access to all standard EXi Program features, including the Common LFO, Common Step Sequencer, Key Track 1 & 2, Arpeggiator, EQ, and effects

Unsupported EXi Common parameters

The AL-1 supports all of the EXi Common parameters, except for two of the voice allocation options: **Poly Legato** and **Mono Mode** (Normal/Use Legato Offset). Both of these options are designed for sample playback, and so they don't apply to the AL-1.

All of the other voice allocation options are fully supported, including Mono, Mono Legato, Unison, etc.

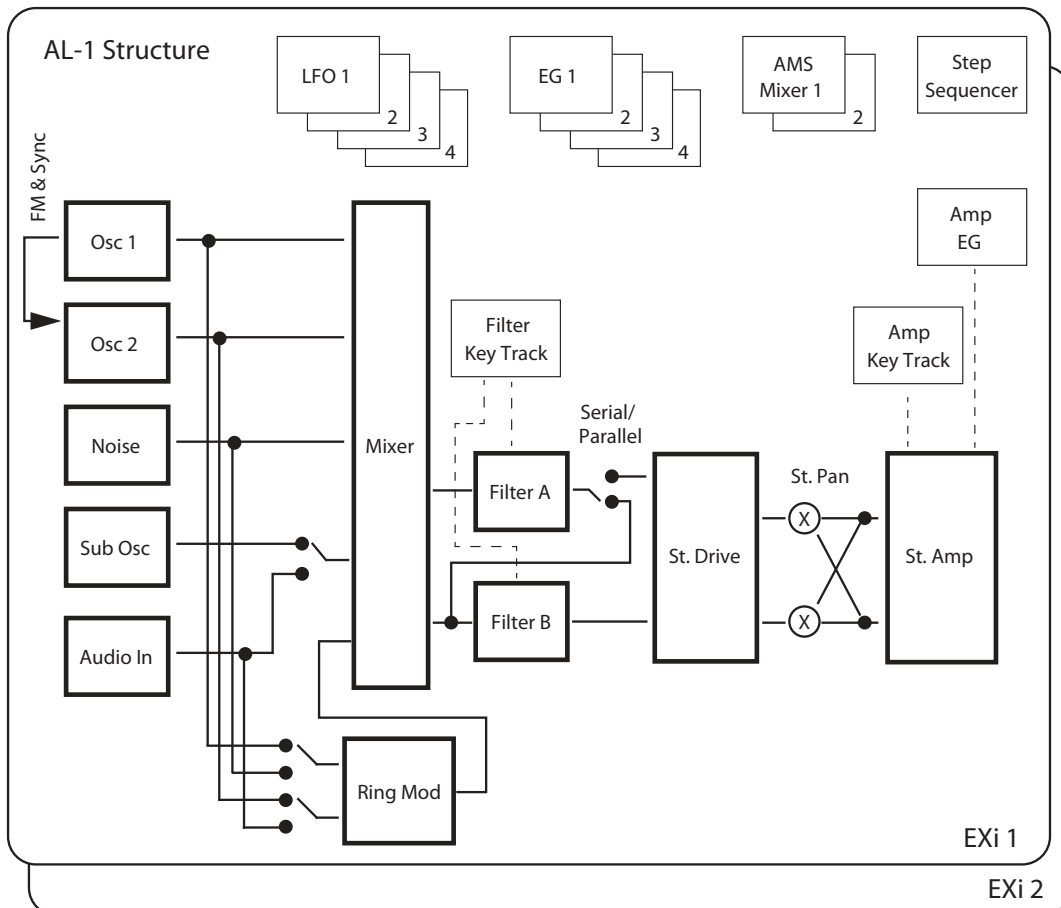
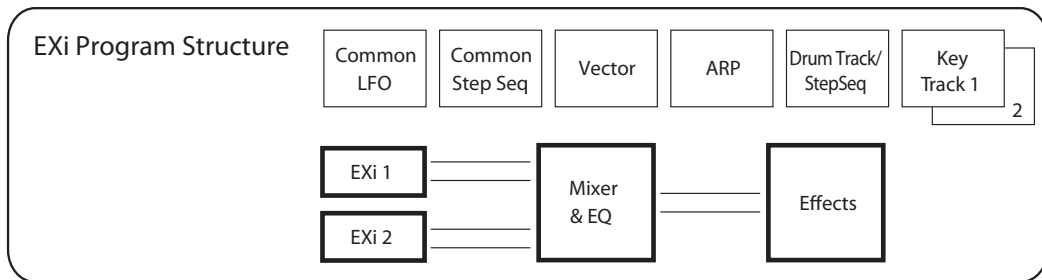

EXi PROGRAM > Home

0-1: Overview



This is the main page of PROGRAM mode. For a full description of this page and all of its functions, please see “EXi PROGRAM > Home” on page 127. This section describes only the overview display, which differs for each individual EXi.

0-1b: Overview and Page Jump

This part of the page shows an overview of the most important settings for the Program’s two EXi instruments. The specific parameters will vary, depending on which EXi are being used. The specific parameters for the AL-1 are described below.

The graphics give you a quick way to check all of these settings at a glance. They also let you jump instantly to any of the displayed parameters. Just touch one of the graphics, and you’ll jump to the page containing its parameters. For instance, if you touch the Filter EG graphic, you’ll go to the Filter EG page.

Tip: Pressing EXIT several times will always bring you back to this page.

Oscillators

This shows the waveforms selected for OSC1, OSC2, and the Sub Oscillator. It also shows the level and balance settings for the three Oscillators, plus the Ring Modulator and Noise Generator. Levels are shown in red, and balance settings in green.

Press this area to jump to the OSC Basic page. For more information, see “4-1: OSC Basic” on page 144.

Common Key Zone

This shows the key zones for EXi1 and EXi2, as set on the Common section’s Program Basic page, in relation to the entire MIDI note range. The range of the 61-, 73-, or 88-note keyboard is also shown, as appropriate.

Press this area to jump to the PROGRAM (Common) > Basic/X-Y/Controllers– Program Basic page.

Pitch

This shows the Pitch EG Select and Pitch LFO Select settings for OSC1 and OSC2.

Touch an EG icon to jump to the Pitch EG/Mod page, or touch an LFO icon to jump to the PROGRAM > AL-1: OSC/Pitch– Pitch Common, Pitch EG/Mod page.

Filter

Filter Routing & Type

Displays the filter routing and type.

Press this area to jump to the PROGRAM > AL-1: Filter– Basic page.

Filter Graphic

Displays the cutoff frequency.

Press this part of the display to jump to the PROGRAM > AL-1: Filter– Basic page.

EG, LFO

Shows the EG and LFO currently used.

Press this part of the display to jump to the PROGRAM > AL-1: Filter– Filter Mod., Filter LFO Mod. page.

Amp

Driver, Low Boost, Pan, Amp Level

This shows the Amp section's **Driver**, **Low Boost**, **Pan**, and **Amp Level** values.

If the Driver section's **Bypass** is on, **Driver** and **Low Boost** are not shown.

Press this area to jump to the PROGRAM > AL-1: Amp-Amp/Driver page.

EGs, LFOs, and Step Sequencer

Step Sequencer Graphic

This shows a graphic overview of the per-voice step sequencer.

Press this area to jump to the PROGRAM > AL-1: Step Seq/LFO- Step Sequencer page.

EG 1...4, Amp EG Graphics

These show the shapes of the five EGs. Touch any of them to jump directly to the corresponding edit page.

LFO 1, 2, 3, 4 Graphic

These show the waveforms and shapes of the four LFOs. Touch any of them to jump directly to the corresponding edit page.

0-1d: Common

3Band EQ Graphic

| | |
|-------------------------------|--------------------|
| Mute (1) | [On, Off] |
| Mute (2) | [On, Off] |
| Mute (DrumT) | [On, Off] |
| EXi1 Instrument Volume | [000...127] |
| EXi2 Instrument Volume | [000...127] |
| Drum Track Volume | [000...127] |

This is the same as with HD-1 programs. For more information, please see "0-1d: Common" on page 4.

✓ 0-1: Page Menu Commands

- Compare →p.112
- Write Program →p.112
- Exclusive Solo →p.113
- Show MS/WS/DKit Graphics →p.113
- Add To Set List →p.113
- Initialize Program →p.113
- PAGE →p.126
- MODE →p.126

PROGRAM > AL-1: OSC/Pitch

These pages control the most basic elements of AL-1's sounds: the waveforms that the oscillators play, and the pitch at which it plays them. For instance, you can:

- Select the waveforms for Oscillator 1, Oscillator 2, and the Sub-Oscillator.

- Set the basic pitch of the sound, including the octave, fine tuning, and so on.
- Control pitch modulation from a wide variety of sources, such as JSX, LFOs, and EGs.

4-1: OSC Basic

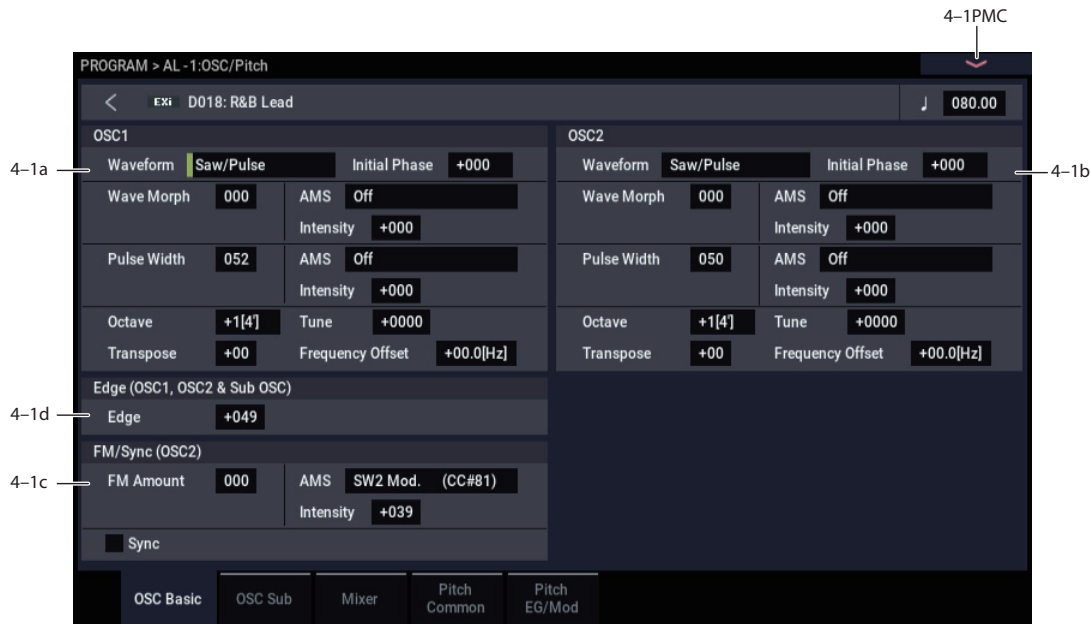

Modeling vintage analog synths

NAUTILUS and the AL-1 provide a range of features for modeling vintage analog synths. Instead of simply providing fixed presets to choose between, there are separate parameters for individual synth characteristics—which means that you can mix and match as desired, for an even broader timbral palette.

For more information on modeling specific aspects of vintage synths, see the references below.

- Oscillator timbre: see “Edge” on page 146
- Oscillator pitch: see “Randomizing frequency for an analog feel” on page 146
- Unison pitch: see “Thickness” on page 132
- Oscillator interaction: see “Initial Phase” on page 145
- Basic filter characteristics: see “Filter Routing” on page 154
- Filter timbre: see “Resonance Bass” on page 156
- Monophonic voice assignment: see “Priority” on page 131
- Portamento: see “Mode” on page 151

4-1a: Oscillator 1

Waveform

Waveform [Saw, Pulse, Saw/Pulse, Double Saw, Detuned Saw 1, Detuned Saw 2, Triangle, Square/Triangle]

This selects the waveform for Oscillator 1, and will also affect the behavior of the **Wave Morph** and **Pulse Width/Phase/Detune** parameters, below.

Saw produces a sawtooth wave—the traditional buzzy analog synth sound.

Pulse produces a square wave with variable pulse width, as controlled by the **Pulse Width** parameter below.

Saw/Pulse creates both of the waveforms at the same time. You can crossfade between the two using the **Wave Morph** parameter, below.

Double Saw produces two sawtooth waveforms simultaneously. You can adjust the phase of the second sawtooth using the aptly-named **Phase** parameter, below, and adjust its volume with the **Wave Morph** parameter.

Detuned Saw 1 produces two detuned sawtooth waveforms simultaneously. **Detune** controls the amount of detuning, and **Wave Morph** adjusts the volume of the second sawtooth.

Detuned Saw 2 is similar to **Detuned Saw 1**, except that the second sawtooth is 180 degrees out of phase. This produces a timbre similar to pulse width modulation, with the **Detune** parameter controlling both detune and the speed of the PWM effect.

Triangle produces a pure tone with relatively few overtones.

Square/Triangle simultaneously creates a square wave (in which the pulse width is fixed at 50%) and a triangle wave.

Wave Morph crossfades between the two.

Initial Phase [-180...+180, Random]

This controls the initial phase of Oscillator 1, in 1-degree increments.

Random: with each note-on, the waveform will start from a random point along the waveform, to simulate the varying phase relationships between oscillators in analog synthesizers.

Wave Morph [000...100]

The function of this parameter changes depending on the **Waveform** selection, above.

When **Waveform** is set to either **Saw/Pulse** or **Square/Triangle**, **Wave Morph** crossfades between the two waveforms. At **0**, you'll hear only the first waveform; at **100**, you'll hear only the second waveform; and at **50**, you'll hear an equal mix of both.

When **Waveform** is set to **Double Saw**, **Detuned Saw 1**, or **Detuned Saw 2**, **Wave Morph** controls the volume of the second Sawtooth wave.

Wave Morph is not available when the **Waveform** is set to Saw, Pulse, or Triangle.

AMS [List of AMS Sources]

This selects an AMS source to control **Wave Morph**. For a list of AMS sources, see "Alternate Modulation Source (AMS) List" on page 903.

AMS Intensity [-100...+100]

This controls the depth and direction of the AMS modulation for **Wave Morph**.

Pulse Width/Phase/Detune [000...100]

The name and function of this parameter changes depending on the **Waveform** selection, above.

When the **Waveform** is set to Pulse or Saw/Pulse, this is named **Pulse Width**, and controls the width of the Pulse waveform. For details, see "More on Pulse Width," below.

When **Waveform** is set to **Double Saw**, it is named **Phase**, and controls the phase relationship between the two Sawtooth waves.

When **Waveform** is set to **Detuned Saw 1** or **2**, this is named **Detune**, and controls the detune amount between the two Saws. The adjustments are in half-cent increments, so that 0 = 0 cents, 50 = 25 cents, and 100 = 50 cents. Saw 1 is tuned up, and Saw 2 is tuned down, so that the tonal center is maintained.

More on Pulse Width

Pulse waveforms are simple, rectangular shapes. The Pulse Width sets the percentage of the waveform spent in the "up" position. A few examples are shown in the diagram below. Note that a square wave is just a pulse wave with the width set to 50%.

The width controls the timbre of the oscillator, from pure and hollow at 50% (a square wave) to thin and reedy at the extremes.

At settings of **0** and **100**—or when the Pulse Width is modulated to these values via AMS— the Pulse wave will be silent, since these eliminate the "pulse" altogether.

Pulse waveform at different widths

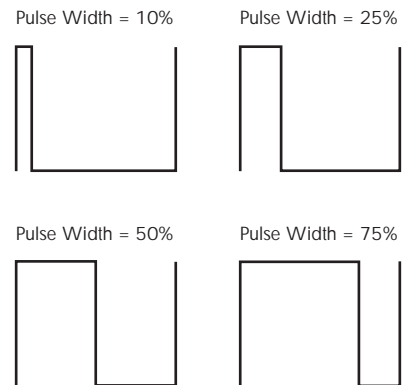

The real magic of the pulse wave comes when you modulate the width, using the AMS source and intensity below. Try using a medium-speed triangle LFO, or a sweeping EG.

AMS [List of AMS Sources]

This selects an AMS source to control **Pulse Width/Phase/Detune**. For a list of AMS sources, see "Alternate Modulation Source (AMS) List" on page 903.

AMS Intensity [-100...+100]

This controls the depth and direction of the AMS modulation for **Width/Phase/Detune**.

Waveform Type and Modulatable Parameters

| Waveform Type | Morph | Pulse Width/Phase/Detune |
|-----------------|---------------------------------|--------------------------|
| Saw | n/a | n/a |
| Pulse | n/a | Pulse Width |
| Saw/Pulse | Xfade between saw and pulse | Pulse Width |
| Double Saw | Volume of 2nd saw | Phase |
| Detuned Saw 1 | Volume of 2nd saw | Detune |
| Detuned Saw 2 | Volume of 2nd saw | Detune and PWM effect |
| Triangle | n/a | n/a |
| Square/Triangle | Xfade between square & triangle | n/a |

Frequency

Note: The Sub-Oscillator's frequency is always exactly one octave below that of Oscillator 1. This means that adjusting any of the controls in this section, including **Octave**, **Transpose**, **Tune**, and **Frequency Offset**, will affect the Sub-Oscillator as well as Oscillator 1.

Octave [-2[32'], -1[16'], +0[8'], +1[4'], +2[2']]

This sets the basic pitch of Oscillator 1, in octaves. The default is +0[8'].

Transpose [-12...+12]

This adjusts the pitch in semitones, over a range of ± 1 octave.

Tune [-1200...+1200]

This adjusts the pitch in cents, over a range of ± 1 octave. A cent is 1/100 of a semitone.

Frequency Offset [-10.0Hz ... +10.0Hz]

This adjusts the pitch by increments of 0.1 Hz. **Frequency Offset** is different from **Tune** in that, when used to detune the two oscillators, it can create a constant beat frequency across the range of the keyboard.

Randomizing frequency for an analog feel

You can use various methods to randomize the oscillator frequency, in order to simulate the instability of analog oscillators:

- Simulate analog drift by modulating pitch with one of the **Continuous Random** LFO waveforms.
- Use **Tune** or **Frequency Offset** to detune the oscillators a tiny bit.
- Set the **Scale Random** parameter (in the Common section, Basic/X-Y/Controllers page, EXi Basic tab) to 1, 2, or 3 to create small amounts of random pitch variation at note-on.

4-1b: Oscillator 2

Oscillator 2 is very similar to Oscillator 1, as described above. The only differences are:

- Oscillator 2 does not include the **Triangle** or **Square/Triangle** waveforms.
- Oscillator 2's pitch does not affect the Sub-Oscillator.
- When Sync is enabled, Oscillator 2's **Initial Phase** setting affects only the very beginning of the sound, before Oscillator 1 completes its first cycle. After that, Oscillator 2's phase is controlled by Oscillator 1.

4-1c: FM/Sync**FM Amount** [000...100]

Oscillator 1 is the modulator, and Oscillator 2 is the carrier. In other words, FM affects the timbre of Oscillator 2, and does not affect the timbre of Oscillator 1.

You can create stable, periodic waveforms by setting **FM Amount** to any multiple of 6, such as **6, 12, 18, 24**, etc. At other settings, the signal will "roll around" in interesting ways.

This feature is similar to a classic five-voice analog synthesizer's "Osc B to Freq A" function, except that the depth can be up to eight times greater—16 octaves instead of 2.

To create a cool sync-like sound with FM:

1. Set Oscillator 1's Waveform to Pulse.
2. Assign an AMS source, such as an EG or LFO, to modulate Oscillator 1's Pulse Width.
3. Set Oscillator 2's Waveform to Pulse.
4. Set Oscillator 2's Pulse Width to 50.
5. Set the FM amount to 24.

Note also that FM, Sync, and Ring Mod can all be used simultaneously.

AMS [List of AMS Sources]

This selects an AMS source to control the **FM Amount**. For a list of AMS sources, see "Alternate Modulation Source (AMS) List" on page 903.

Intensity [-100...+100]

This controls the depth and direction of the **FM Amount** AMS modulation.

Sync [Off, On]

When **Sync** is **On**, Oscillator 1 controls the pitch of Oscillator 2, and changing or modulating Oscillator 2's frequency changes its timbre, instead of its pitch.

Every time that Oscillator 1 begins a new cycle (the instant that it passes through zero going from negative to positive), Oscillator 2 snaps back to the start of its waveform.

Note that FM, Sync, and Ring Mod can all be used simultaneously.

To create the classic sync sweep sound:

1. Turn Sync On.
2. Assign an EG as the AMS source for Oscillator 2 Pitch.
3. Now, the EG is controlling the sync sound.
4. Set the EG and Pitch AMS Intensity parameters to create the desired sync sweep.

4-1d: Edge (OSC 1, OSC 2 & Sub OSC)**Edge** [-100...+100]

This controls the high-frequency character of Oscillator 1, Oscillator 2, and the Sub Oscillator.

Set it to 0 for a timbre similar to vintage American analog synths, and to higher values for "edgier" tones.

Negative values result in warmer, darker tones, to create an oscillator timbre similar to the MS-20.

✓ 4-1: Page Menu Commands

- Compare →p.112
- Write Program →p.112
- Exclusive Solo →p.113
- PAGE →p.126
- MODE →p.126

4-2: OSC Sub

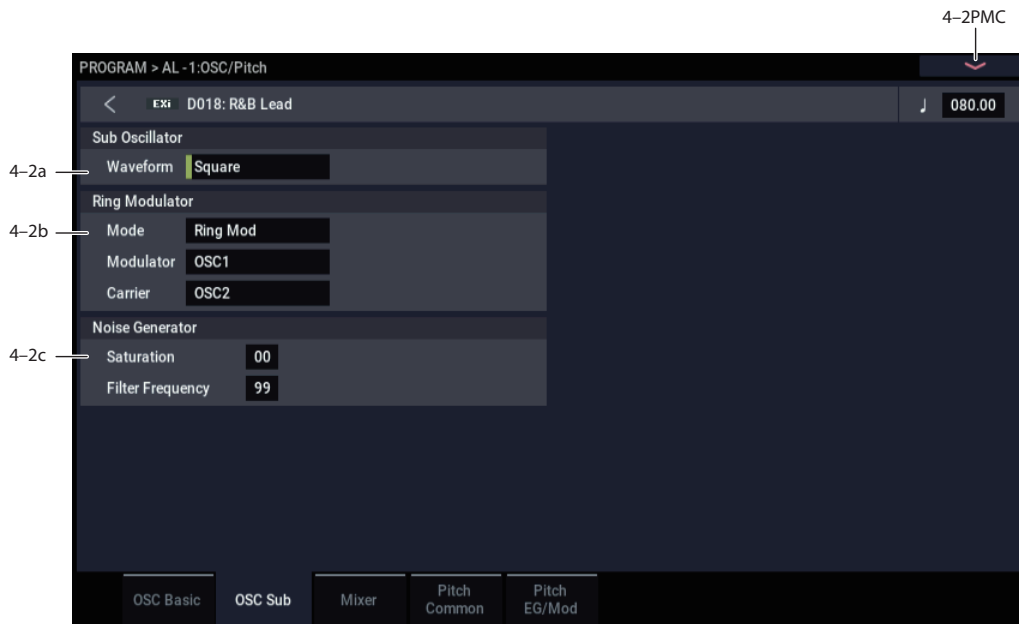

4-2a: Sub Oscillator

The Sub Oscillator plays exactly one octave below Oscillator 1. All Oscillator 1 pitch mod effects the Sub Oscillator as well.

Waveform [Square, Triangle]

This selects the basic waveform of the Sub-Oscillator. The **Triangle** waveform's amplitude is three times that of the square, to compensate for the difference in perceived loudness. This means that similar Level settings at the mixer result in similar amounts of "boom."

Note that this is different from Oscillator 1's **Triangle** wave. In Oscillator 1, the **Triangle** amplitude is the same as that of the other waveforms, resulting in a lower perceived volume (just like on classic analog synths).

4-2b: Ring Modulator

The Ring Modulator has its own input to the Mixer section. The default volume is 0, so to hear it, you'll need to turn it up!

When the frequencies of the **Carrier** and the **Modulator** are the same, the Ring Modulator produces steady, constant waveforms. When the two are detuned, it produces more movement and overtones.

Note that FM, Sync, and Ring Mod can all be used simultaneously.

 Even though the oscillators themselves have extremely low aliasing, Ring Mod can produce aliasing - especially at higher frequencies.

Mode [Ring Mod, AM, Rectify, Clip]

This selects between four different variations of ring modulation.

Ring Mod produces the traditional ring modulation effect.

AM includes both the traditional ring modulation effect and the dry signal of the Carrier input.

Rectify means that any negative parts of the Modulator's waveform are flipped around to be positive instead. If the **Modulator** is a square wave, this mode sounds pretty much like just listening to the **Carrier** alone.

Clipped means that the Modulator input is clipped to positive values before going into the Ring Mod; any negative parts of the waveform are chopped off and thrown away.

Modulator [OSC 1, Noise]

This selects the modulator source for the Ring Modulator. **Rectify** and **Clip**, above, both affect the **Modulator** signal.

Carrier [OSC 2, Ext Input]

Selects the carrier source for the ring modulator.

Ext Input uses the audio input selected under Sub OSC/Audio Input, on the Mixer page. For more information, see "4-3c: Sub OSC/Audio Input" on page 149.

4-2c: Noise Generator

The noise generator includes **Saturation**, for creating unique and chaotic noise effects, and a dedicated 1-pole filter to control noise color.

For standard white noise, set the **Saturation** to **0**, and the **Filter Frequency** to **99**.

For colored noise (such as pink noise), set the **Saturation** to **0**, and reduce the **Filter Frequency** as desired.

To create "speckled noise" such as rocket sounds and thunder, set **Saturation** to **99**, and **Filter Frequency** to **10**.

To create key contact noise (such as you might find on vintage analog synths), create speckled noise as described above, and then use a fast EG to control its volume in the mixer.

Saturation [0...99]

This control clips the noise signal, for added crunch. Subtle variations in saturation are more noticeable with very low **Filter Frequency** settings (see below), allowing you to create organic, rumbling timbres.

Filter Frequency [0...99]

This is a simple, 1-pole lowpass filter for controlling the “color” of the noise.

✓ **4-2: Page Menu Commands**

- Compare →p.112
- Write Program →p.112
- Exclusive Solo →p.113
- PAGE →p.126
- MODE →p.126

4-3: Mixer

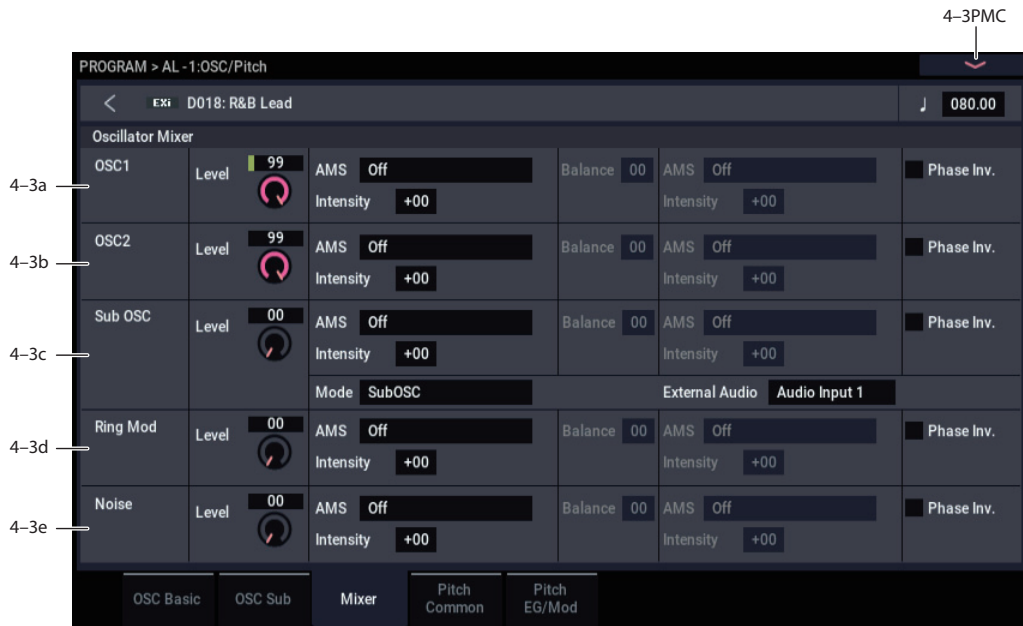

The Mixer page controls the volume levels for the five main parts of the Oscillator, and also controls the routing to the filter section. For instance, you can:

- Control the volume levels for Oscillator 1, Oscillator 2, the Sub Oscillator (or an Audio Input), the Ring Modulator, and the Noise Generator.
- Modulate these volume levels via AMS.
- When the **Filter Routing** is set to either **Serial** or **Parallel**, you can route each of the five Oscillator elements through Filter A, Filter B, or a combination of the two - and then modulate that routing via AMS.
- Select an audio input to route through the filters, driver, ring modulator, and effects.

4-3a: OSC1

Level [0...99]

This controls the volume level for Oscillator 1.

AMS [List of AMS Sources]

This selects an AMS source to control the **Oscillator 1 Level**. For a list of AMS sources, see “Alternate Modulation Source (AMS) List” on page 903.

Intensity [-99...+99]

This controls the depth and direction of the **Oscillator 1 Level** AMS modulation.

Balance [0...99]

This controls the filter routing for Oscillator 1. It applies only when the **Filter Routing** is set to either **Serial** or **Parallel**; otherwise, it is grayed out.

0 is the default, and means that Oscillator 1 goes into Filter A. If the **Filter Routing** is set to **Serial**, it will also pass through Filter B.

99 means that Oscillator 1 goes into Filter B.

In between, the oscillator will go to a combination of both filters. By modulating the **Balance** via AMS, you can crossfade between routing through Filter A and Filter B. For more information, see “Interaction between the filters and the mixer,” on page 154.

AMS [List of AMS Sources]

This selects an AMS source to control the **Oscillator 1 Balance**. For a list of AMS sources, see “Alternate Modulation Source (AMS) List” on page 903.

Intensity [-99...+99]

This controls the depth and direction of the **Oscillator 1 Balance** AMS modulation.

Phase Invert [Off, On]

This inverts the phase of Oscillator 1.

4-3b: OSC2

Oscillator 2 has the same mixer parameters as described under “4-3a: OSC1,” above.

4-3c: Sub OSC/Audio Input

In addition to the Level, Balance, AMS, and Phase Invert parameters described under “4-3a: OSC1,” above, this section has controls for using an external audio input.

Mode [Sub OSC, External Audio Input]

This selects whether the mixer input will be used for the Sub Oscillator, or the audio input selected below.

External Audio [Audio Inputs 1, 2, USB 1, 2]

This selects the audio input used for both this mixer channel and the Ring Modulator.

The Ring Modulator can use the selected audio input even if **Mode**, above, is set to **Sub OSC**.

4-3d: Ring Mod

The Ring Modulator has the same mixer parameters as described under “4-3a: OSC1,” above.

4-3e: Noise

The Noise Generator has the same mixer parameters as described under “4-3a: OSC1,” above.

✓ 4-3: Page Menu Commands

- Compare →p.112
- Write Program →p.112
- Exclusive Solo →p.113
- PAGE →p.126
- MODE →p.126

4-4: Pitch Common

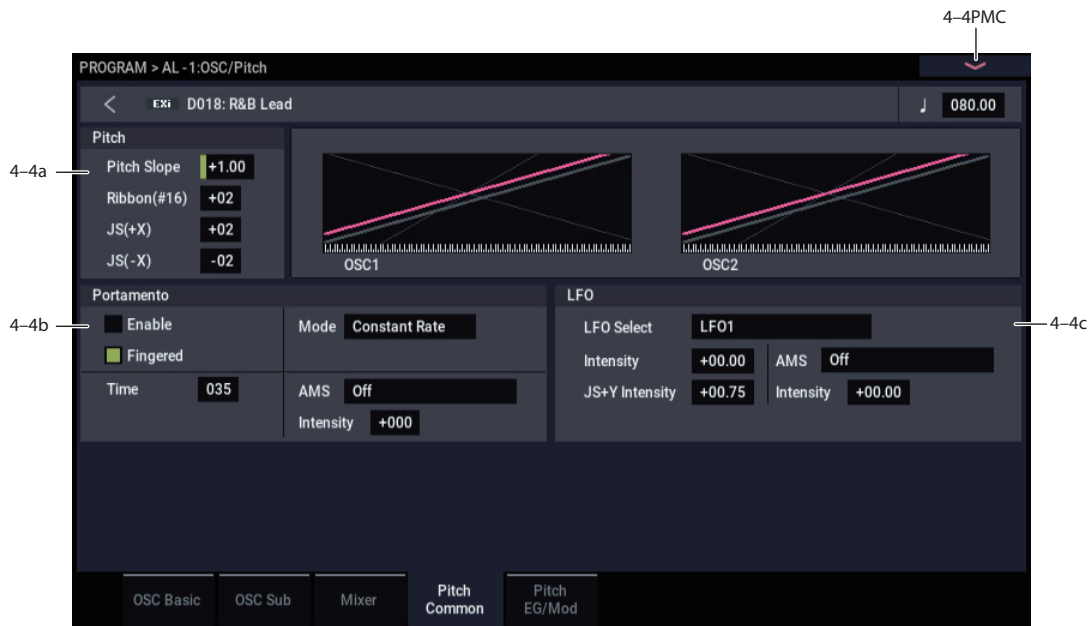

This page lets you modulate the pitch of Oscillators 1, 2, and the Sub Oscillator simultaneously, so that the modulation applies equally to all three oscillators. For example, you can:

- Set up pitch bend from Joystick X (with separate settings for bending up and bending down).
- Use Pitch Slope to control how the pitch changes when you play up and down the keyboard.
- Set up Portamento.
- Assign an LFO to modulate the pitch of all three oscillators simultaneously.

4-4a: Pitch

Pitch Slope [-1.00...+0.00...+2.00]

Normally, this should be set to the default of +1.00.

Pitch Slope, pitch, and note

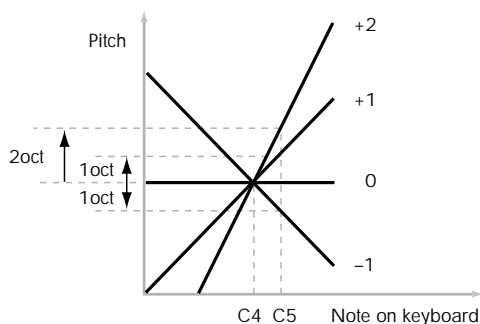

Positive (+) values cause the pitch to rise as you play higher on the keyboard, and **negative (-)** values cause the pitch to fall as you play higher on the keyboard.

When this is set to **0**, playing different notes on the keyboard won't change the pitch at all; it will be as if you're always playing C4. This can be useful for special effects sounds, for instance.

If you want to create more complex effects, you can assign key tracking as an AMS source.

JS+ X [-60...+60]

Sets how much the pitch will change (in semitones) when you move the joystick to the right. Normally, this is set to a positive value. For instance, when the value is set to "+12" and you move the joystick all the way to the right, the pitch of any notes you play on the keyboard will be shifted up one octave.

JS- X [-60...+60]

Sets how much the pitch will change (in semitones) when you move the joystick to the left. Normally, this is set to a negative value. For instance, when the value is set to "-60" and you move the joystick all the way to the left, the pitch of the notes you play on the keyboard will be shifted down five octaves. You can use this to create guitar-like whammy bar effects.

4-4b: Portamento

Portamento lets the pitch glide smoothly between notes, instead of changing abruptly.

Enable [Off, On]

On (checked): Turns on Portamento, so that pitch glides smoothly between notes.

Off (unchecked): Turns off Portamento. This is the default state.

Fingered [Off, On]

This parameter allows you to control Portamento through your playing style. When it's enabled, playing legato will turn on Portamento, and playing detached will turn it off again.

This option is only available when Portamento Enable is turned on.

On (checked): Turns on Fingered Portamento.

Off (unchecked): Turns off Fingered Portamento.

Mode [Constant Rate, Constant Time]

Constant Rate means that Portamento will always take the same amount of time to glide a given distance in pitch - for instance, one second per octave. Put another way, gliding several octaves will take much longer than gliding a half-step.

Constant Time means that Portamento will always take the same amount of time to glide from one note to another, regardless of the difference in pitch. This is especially useful when playing chords, since it ensures that each note in the chord will end its glide at the same time.

Time [000...127]

This controls the portamento time. Higher values mean longer times, for slower changes in pitch. When **Time** is set to 0, the pitch will be reached instantly—just as if Portamento **Enable** was turned **Off**.

AMS [List of AMS Sources]

This selects an AMS source to control the **Portamento Time**. For a list of AMS sources, see “Alternate Modulation Source (AMS) List” on page 903.

The modulation occurs only at note-on. This means that you can change the time for the *next* pitch glide, but you can't change any glides which are already in progress.

Intensity [-127...+127]

This controls the depth and direction of the **Portamento Time** AMS modulation.

Assigning SW1 or SW2 to Portamento On/Off

You can use the two assignable switches, SW1 and SW2, to turn portamento on and off. For more information, see “1-8b: Panel Switch Assign” on page 48.

To do so:

1. Go to the PROGRAM > Basic/X-Y/Controllers—Controllers page.
2. Under Switch tab, select the RT Control by the Target of either Switch1 or Switch2, and set the RT Control to Portamento SW (CC#65).

Now, the selected button will enable and disable Portamento. It will also send the MIDI Portamento controller, CC#65.

MIDI Even if you don't assign SW1/2 to Portamento, you can still use MIDI Controller #65 to turn Portamento on and off.

4-4c: LFO

LFO Select [LFO 1, LFO 2, LFO 3, LFO 4, Common LFO]

This selects an LFO to modulate all oscillators simultaneously. This shared modulation can be useful for vibrato, among other things.

The **LFO Intensity**, **JS+ Y Intensity**, and **AMS** are all summed together to produce the final amount of LFO pitch modulation.

LFO Intensity [-48.00...+48.00]

This controls the initial effect of the LFO on the pitch, in semitones, before any JS+Y or AMS modulation.

Negative (-) settings will invert the phase of the LFO.

JS+Y Intensity [-48.00...+48.00]

Moving the joystick “up” from the center detent position, away from yourself, produces the JS+Y controller. You can use this to scale the amount of the LFO applied to the pitch. This parameter sets the maximum amount of LFO modulation added by JS+Y, in semitones.

As this value is **increased**, moving the joystick in the +Y direction will cause the LFO to produce deeper pitch modulation.

Negative (-) settings will invert the phase of the LFO. You can also use this to reduce the initial amount of the LFO, as set by **LFO1 Intensity**, above.

AMS [List of AMS Sources]

This selects an AMS modulation source to scale the amount of the LFO applied to pitch.

For a list of AMS sources, see “Alternate Modulation Source (AMS) List” on page 903.

Intensity [-48.00...+48.00]

This controls the depth and direction of the LFO AMS modulation, in semitones.

✓ 4-4: Page Menu Commands

- Compare →p.112
- Write Program →p.112
- Exclusive Solo →p.113
- PAGE →p.126
- MODE →p.126

4–5: Pitch EG/Mod

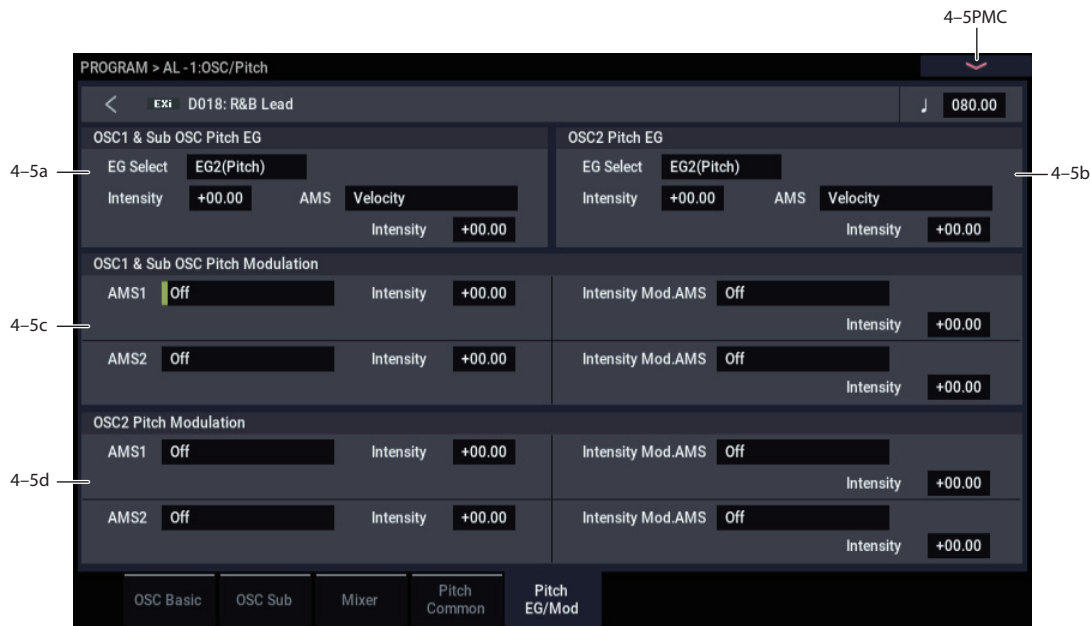

This page lets you modulate the pitches of Oscillators 1 and 2 separately—as opposed to the Pitch Common page, whose controls affect both Oscillators at once.

All pitch modulation for Oscillator 1 also affects the Sub Oscillator.

4–5a: OSC 1 & Sub OSC Pitch EG

EG Select [EG 1 (Filter), EG 2 (Pitch), EG 3, EG 4, Amp EG]

This selects an EG to modulate the pitch of Oscillator 1 and the Sub Oscillator.

There are four assignable EGs, in addition to the Amp EG. Each of these can be used as a modulation source to control a wide variety of parameters.

In the midst of all this flexibility, we thought it would also be good to provide a little structure. With this in mind, EG 1 is named EG 1 (Filter) and EG 2 is labeled EG 2 (Pitch).

Please take these names as suggestions, rather than restrictions. If you like, you’re free to use these EGs to control any EG or AMS destination, or to use other EGs to control Filter Frequency and Pitch.

Intensity [-48.00...+48.00]

This controls the initial effect of the Pitch EG on the frequency of Oscillators 1 and the Sub Oscillator, in half-steps, before any AMS modulation.

The Pitch EG’s shape can swing all the way from +99 to -99. When the Intensity is set to a **positive** (+) value, positive values from the EG raise the pitch, and negative values lower the pitch.

When the Intensity is set to a **negative** (-) value, the effect of the EG is reversed; positive EG values mean *lower* pitches, and negative EG values mean *higher* pitches.

AMS [List of AMS Sources]

This selects an AMS modulation source to scale the amount of the Pitch EG applied to Oscillator 1 and the Sub Oscillator.

For a list of AMS sources, see “Alternate Modulation Source (AMS) List” on page 903.

Intensity [-48.00...+48.00]

This controls the depth and direction of the pitch EG AMS modulation. The AMS modulation and the initial Intensity are added together to determine the Pitch EG’s final effect.

4–5b: OSC 2 Pitch EG

Oscillator 2 has the same Pitch EG parameters as described under “4–5a: OSC 1 & Sub OSC Pitch EG,” above.

4–5c: OSC 1 & Sub OSC Pitch Modulation

AMS 1 [List of AMS Sources]

This selects the first modulation source for controlling the pitch of Oscillator 1 and the Sub Oscillator. For a list of AMS sources, see “Alternate Modulation Source (AMS) List” on page 903.

Intensity [±48.00 semitones]

This controls the depth and direction of the AMS 1 pitch modulation, in semitones.

Intensity Mod AMS [List of AMS Sources]

You can modulate AMS 1’s Intensity from another AMS source. This selects that source.

Intensity [±48.00 semitones]

This controls the depth and direction of the Intensity Mod AMS, in semitones. The result is summed with the main AMS 1 Intensity to produce the final pitch modulation amount.

AMS 2 [List of AMS Sources]

This selects a second modulation source for controlling the pitch of Oscillator 1 and the Sub Oscillator. For a list of AMS sources, see “Alternate Modulation Source (AMS) List” on page 903.

Intensity [+/-48.00 semitones]

This controls the depth and direction of the AMS 2 pitch modulation, in semitones.

Intensity Mod AMS [List of AMS Sources]

You can modulate AMS 2's Intensity from another AMS source. This selects that source.

Intensity [+/-48.00 semitones]

This controls the depth and direction of the Intensity Mod AMS, in semitones. The result is summed with the main AMS 2 Intensity to produce the final pitch modulation amount.

4-5d: OSC 2 Pitch Modulation

Oscillator 2 has the same Pitch Modulation parameters as described under “4-5c: OSC 1 & Sub OSC Pitch Modulation,” above.

✓ 4-5: Page Menu Commands

- Compare →p.112
- Write Program →p.112
- Exclusive Solo →p.113
- PAGE →p.126
- MODE →p.126

PROGRAM > AL-1: Filter

5-1: Basic



Interaction between the filters and the mixer

When the **Filter Routing** is set to either **Single** or **24dB (4-Pole)**, the routing from the Oscillator section into the Filter section is fairly simple. There's only a single filter, and that filter processes all of the Oscillator elements.

Things can get more interesting when the **Filter Routing** is set to **Serial** or **Parallel**. In these modes, The Mixer page's **Balance** parameters let you separately control the filter routing for each of the five inputs: Oscillator 1, Oscillator 2, the Sub Oscillator, the Ring Modulator, and the Noise Generator.

When an input's **Balance** is set to **0**, it goes into Filter A. (Note that if the **Filter Routing** is set to **Serial**, the signal will also pass through Filter B.)

If the input's **Balance** is set to **99**, it goes directly into Filter B, regardless of whether the routing is set to **Serial** or **Parallel**.

Standard serial configuration

To create a standard serial filter configuration:

1. Set the **Filter Routing** to **Serial**.

This connects the output of Filter A to the input of Filter B.

2. Set all of the mixer's **Balance** controls to **0**.

This makes all of the inputs go to Filter A first, and then through Filter B.

Standard parallel configuration

To create a standard parallel filter configuration:

1. Set the **Filter Routing** to **Parallel**.
2. Set all of the mixer's **Balance** controls to **50**.

This routes all of the inputs to both filters, at equal volumes.

Dual signal paths

You can also send one Oscillator through Filter A, and the other through Filter B, to create a layered sound. For instance:

1. Set the **Filter Routing** to **Parallel**.
2. Set **Oscillator 1's Balance** to **0**.
This routes Oscillator 1 to Filter A.
3. Set **Oscillator 2's Balance** to **99**.
This routes Oscillator 2 to Filter B.

Anywhere in-between

If an input's **Balance** is set between **1** and **98**, it will go to a combination of both filters—so that many “in between” filter effects are available.

Finally, by modulating an input's **Balance** via AMS, you can crossfade between routing through Filter A and Filter B.

5-1a: Routing

Filter Routing [Single, Serial, Parallel, 24dB (4-Pole)]

There are two filters, Filter A and Filter B. This parameter controls whether one or both of the filters are used, and if both are used, it controls how they are connected to each other.

Single. This uses only Filter A as a single 2-pole, 12dB/octave filter (6dB for Band Pass and Band Reject). When this option is selected, the controls for Filter B will be grayed out. A classic synthesizer expander module used this type of filter.

Serial. This uses both Filters A and B as separately controllable 2-pole filters. The output of Filter A is processed through Filter B.

Parallel. This also uses both Filter A and Filter B. Unlike Serial, above, the outputs of the two filters are kept separate, with individual control over both level and pan.

24dB (4-Pole). This merges both filters to create a single 4-pole, 24dB/octave filter (12dB for Band Pass and Band Reject). In comparison to Single, this option produces a sharper roll-off beyond the cutoff frequency, as well as a slightly more delicate resonance. Many classic analog synths used this general type of filter.

When **24dB (4-Pole)** is selected, only the controls for Filter A are active; the controls for Filter B will be grayed out. Also, note that the **Multi Filter** is not available in this mode.

5-1b: Filter A

Filter Type [Low Pass, High Pass, Band Pass, Band Reject, Multi Filter]

The filter will produce very different results depending on the selected filter type. The selections will change slightly according to the selected **Filter Routing**, to show the correct cutoff slope in dB per octave.

Low Pass. This cuts out the parts of the sound which are **higher** than the cutoff frequency. Low Pass is the most common type of filter, and is used to make bright timbres sound darker.

High Pass. This cuts out the parts of the sound which are **lower** than the cutoff frequency. You can use this to make timbres sound thinner or more buzzy.

Band Pass. This cuts out all parts of the sound, both highs and lows, except for the region around the cutoff frequency. Since this filter cuts out both high and low frequencies, its effect can change dramatically depending on the cutoff setting and the oscillator's multisample.

With low resonance settings, you can use the Band Pass filter to create telephone or vintage phonograph sounds. With higher resonance settings, it can create buzzy or nasal timbres.

Band Reject. This filter type—also called a notch filter—cuts only the parts of the sound directly around the cutoff frequency. Try modulating the cutoff with an LFO to create phaser-like effects.

Multi Filter. This is a complex filter which is capable of all of the above filter types, and many more besides. For more information, see “5-2: Multi Filter,” on page 157.

The Multi Filter is available only for Filter A, and only when the Filter Routing is set to **Single**, **Serial** or **Parallel**.

Filter Types and Cutoff Frequency

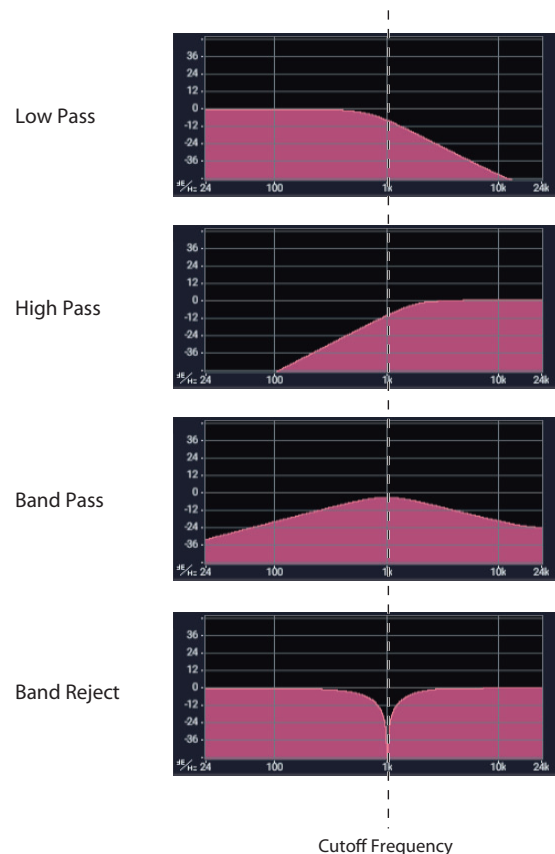

Bypass

[Off, On]

This lets you bypass Filter A completely.

If **Bypass** is **Off**, Filter A functions normally.

When **Bypass** is **On**, Filter A has no effect on the input signal.

Trim

[00...99]

This adjusts the volume level at the input to Filter A. If you notice that the sound is distorting, especially with high Resonance settings, you can turn the level down here, or at the Output Level.

Note that the filter will not clip internally, so there is no difference between adjusting the Input Trim and the Output Level. Either of these controls will allow you to minimize clipping later in the signal chain, such as may occur in the Drive section and in some effects.

Output Level

[00...99]

This controls the output level of Filter A. You can use this to balance the volumes of Filters A and B when the Routing is set to Parallel, or to turn down the volume to avoid clipping later in the signal chain.

AMS

[List of AMS Sources]

This selects a modulation source to control the **Output Level**. For a list of AMS sources, see “Alternate Modulation Source (AMS) List” on page 903.

Intensity

[-99...+99]

This controls the depth and direction of the **Output Level** modulation.

Frequency [00...99]

This controls the cutoff frequency of Filter A, in increments of 1/10 of an octave. The specific effect of the cutoff frequency will change depending on the selected **Filter Type**, as described above.

Frequency Fine [-99...+99]

This provides fine control of the filter cutoff frequency. Each step of this parameter is equal to 1/100 of a step of the main **Frequency** parameter, above.

Resonance Type [Standard, High]

This controls the strength of the filter resonance when the **Filter Routing** is set to **24dB (4-Pole)**. When the routing is set to **Single**, **Serial**, or **Parallel**, this parameter is grayed out.

Standard provides the resonance character of a typical analog 4-pole filter.

High creates a more pronounced resonance.

Resonance Bass [Tight, Full]

This controls the character of the filter resonance at low cutoff frequencies. Its effect is most noticeable with high **Resonance** settings.

Tight produces a more restrained resonance, similar to a classic, American, wood-paneled monophonic synthesizer.

Full produces a wide, boomy resonance, reminiscent of a famous five-voice American synthesizer.

Resonance [00...99]

Resonance emphasizes the frequencies around the cutoff frequency.

When this is set to **0**, there is no emphasis, and frequencies beyond the cutoff will simply diminish smoothly.

At medium settings, the resonance will alter the timbre of the filter, making it sound more nasal, or more extreme.

At very high settings, the resonance can be heard as a separate, whistling pitch.

To make the resonance track the keyboard pitch, see “Key Follow,” on page 159.

Resonance Mod by AMS [List of AMS Sources]

This selects a modulation source to control the Resonance amount. For a list of AMS sources, see “Alternate Modulation Source (AMS) List” on page 903.

Intensity [-99...+99]

This controls the depth and direction of the **Resonance** modulation.

Pan [Random, L001...C064...R127]

This controls the stereo pan for Filter A’s output. It is available only when **Filter Routing** is set to **Parallel**.

When the **Filter Routing** is set to **Single**, **Serial**, or **24dB (4-Pole)**, the Pan parameters will be grayed out.

AMS [List of AMS Sources]

This selects an AMS source to modulate **Pan**. For a list of AMS sources, see “Alternate Modulation Source (AMS) List” on page 903.

Intensity [-99...+99]

This controls the depth and direction of the **Pan** AMS modulation.

5-1c: Filter B

Filter B is available when the **Filter Routing** is set to **Serial** or **Parallel**. Otherwise, its parameters will be grayed out.

Filter B is almost the same as Filter A, but without the **Multi Filter** mode, and with the addition of the **Link** controls, as described below. For all other parameters, please see the descriptions under “5-1b: Filter A,” on page 155.

Link [Off, On]

When **Link** is **On**, most of Filter B’s parameters are grayed out, and are instead controlled by the settings for Filter A.

Specifically, Filter B will use Filter A’s settings for **Resonance**, **Resonance Bass**, and all Frequency and Resonance modulation settings. Filter B’s **Frequency** is also linked to that of Filter A, with an optional frequency offset via the **Link Frequency Offset** parameter, below.

The **Bypass**, **Type**, **Input Trim**, **Output Level**, **Output Level AMS**, **Pan**, and **Pan AMS** parameters are still controlled separately.

Link Frequency Offset [-99...+99]

This offsets Filter B’s Frequency from that of Filter A, and applies only when **Link** is **On**.

When **Link** is **Off**, this parameter is grayed out.

✓ 5-1: Page Menu Commands

- Compare →p.112
- Write Program →p.112
- Exclusive Solo →p.113
- PAGE →p.126
- MODE →p.126

5-2: Multi Filter



This page is available only when the **Filter A Type** is set to **Multi Filter**.

What's a Multi Filter?

Standard multimode filters generate lowpass, highpass, and bandpass filters simultaneously - but only allow you to use one of them at a time.

The Multi Filter gives you access to all three filter modes simultaneously, in any combination, along with the dry input signal. You can choose from a large number of preset combinations, or create your own complex filter modes using the Manual controls.

This is capable of some cool sounds in and of itself, but things really get interesting when you use the Crossfade controls. These allow you to crossfade between two of these filter settings (Mode 1 and Mode 2), using AMS sources such as EGs, LFOs, or real-time controllers.

5-2a: Filter A

| | |
|------------------|--------------------|
| Bypass | [Off, On] |
| Frequency | [00...99] |
| Fine | [-99...+99] |
| Resonance | [00...99] |

These are the same as the similarly-named parameters on the Filter Basic page, as described under “5-1b: Filter A” on page 155.

Edits to the values on this page will be reflected on the Filter Basic page, and vice-versa.

5-2b: Mode Crossfade

Mode 1

[List of filter types]

This sets the filter type for Mode 1.

Low Pass, High Pass, Band Pass, and Band Reject are the standard filter types. For more information, see “Filter Type,” on page 155.

The following types combine two or more filters at equal volumes. **Dry** is the un-filtered input signal. The minus sign (“-”) indicates when the phase of a filter is reversed: **LP+BP, LP-BP, LP-HP, BP+HP, BP-HP, Dry+LP, Dry-LP, Dry+BP, Dry-BP, Dry+LP-HP, Dry+LP-BP, Dry+BP-LP, Dry+BP-HP, Dry+HP-LP, Dry+HP-BP, LP+HP+BP.**

All On uses the Low Pass, High Pass, Band Pass, and Dry signals at equal volumes.

Manual 1 lets you create your own mix of the filters. For more information, see “5-2c: Manual 1,” below.

Mode 2

[List of filter types]

Mode 2 has the same selections as Mode 1, except that the list ends with Manual 2 instead of Manual 1.

Mode 1-2 Crossfade

[00...99]

This fades between the Mode 1 and Mode 2 settings.

0 is all **Mode 1**, **99** is all **Mode 2**, and **1-98** are intermediate values between the two Modes.

AMS

[List of AMS Sources]

This selects a modulation source to control the **Mode 1-2 Crossfade**. For a list of AMS sources, see “Alternate Modulation Source (AMS) List” on page 903.

Intensity

[-99...+99]

This controls the depth and direction of the **Mode 1-2 Crossfade** modulation.

Intensity Mod AMS [List of AMS Sources]

This selects an AMS source to modulate the intensity of the main **Mode 1-2 Crossfade AMS**.

For instance, you can set **AMS** to use one of the LFOs, and then set the **Intensity Mod AMS** to JS -Y. You can then use the joystick to modulate the amount of the LFO.

Intensity [-99...+99]

This controls the depth and direction of the **Intensity Mod AMS**.

5-2c: Manual 1

These parameters let you create your own mix of the filters. When **Mode 1** is set to **Manual 1**, it will use these settings.

You may wonder why Band Reject is not included here. This is because it's not a filter mode per se. Instead, it's created by an equal combination of High Pass and Low Pass. Try it and see!

Lowpass [-99...+99]

This controls the volume of the Lowpass filter output. Negative values invert the phase.

Highpass [-99...+99]

This sets the volume of the Highpass filter output.

Bandpass [-99...+99]

This controls the volume of the Bandpass filter output.

Dry [-99...+99]

This sets the volume of the dry signal.

5-2d: Manual 2

The Manual 2 parameters are identical to those of Manual 1, as described above.

✓ **5-2: Page Menu Commands**

- Compare →p.112
- Write Program →p.112
- Exclusive Solo →p.113
- PAGE →p.126
- MODE →p.126

5-3: Filter Mod.

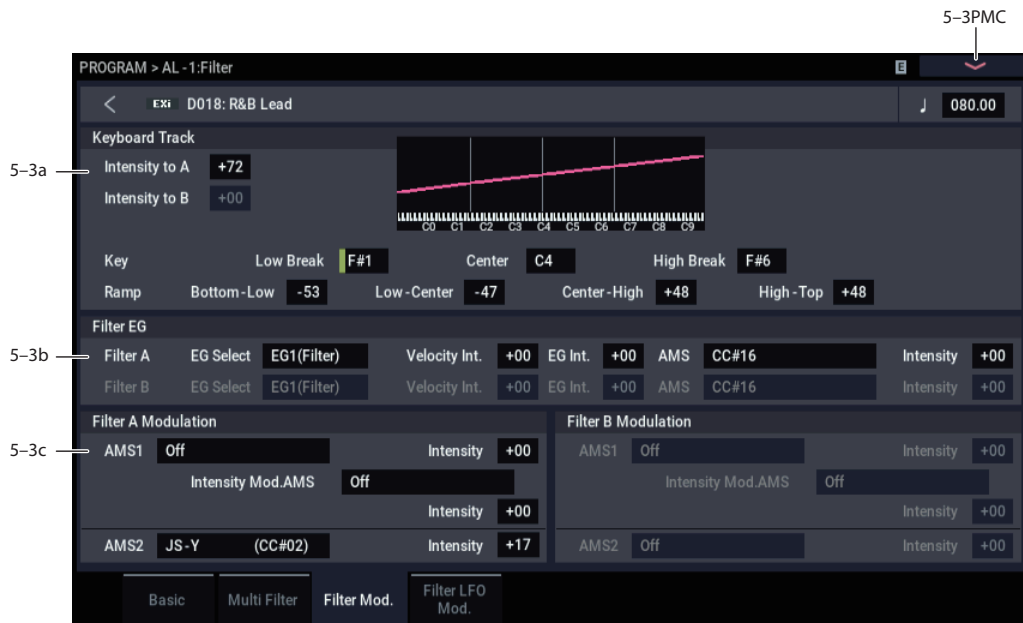

This page contains all of the settings for **Filter Frequency** modulation (except for the LFOs, which are on their own page). Among other things, you can:

- Set up complex keyboard tracking shapes, and control how the tracking affects filter cutoff.
- Control the effect of the Filter Envelope on filter cutoff.
- Assign AMS modulation for filter cutoff.

Filter B is available when the **Filter Routing** is set to **Serial** or **Parallel**. Otherwise, the parameters for Filter B will be grayed out.

The AL-1's Filter keyboard tracking parameters are identical to the HD-1's. For more detailed explanations of the

5-3a: Keyboard Track AMSource

Most acoustic instruments get brighter as you play higher pitches. At its most basic, keyboard tracking re-creates this effect by increasing the cutoff frequency of a lowpass filter as you play higher on the keyboard. Usually, some amount of key tracking is necessary in order to make the timbre consistent across the entire range.

The NAUTILUS keyboard tracking can also be much more complex, since it allows you to create different rates of change over up to four different parts of the keyboard.

parameters, please see "3-2a: Keyboard Track," on page 65.

There is one difference between the two, however: the AL-1's Filter tracking is affected by Portamento, so that it changes smoothly during glides.

Intensity to A [−99...+99]

This controls how much the keyboard tracking will affect Filter A's cutoff frequency. The overall effect of the Keyboard Track is a combination of this **Intensity** value and the overall Keyboard Track shape.

Intensity to B [−99...+99]

This controls how much the keyboard tracking will affect Filter B's cutoff frequency.

Intensity to B applies only when the **Filter Routing** is set to **Serial** or **Parallel**, and when **Link** is **Off**. In **Single** and **24dB (4-Pole)** modes, or if **Link** is **On**, this parameter is grayed out.

Key

Low Break [C−1...G9]

This sets the breakpoint note between the two lower ramps.

Center [C−1...G9]

This sets the center of the keyboard tracking. At this key, the keyboard tracking has no effect on the filter frequency, or on any AMS destinations.

High Break [C−1...G9]

This sets the breakpoint note between the two higher ramps.

Ramp

The effect on the filter cutoff is a combination of the ramp values, as set below, and the Intensity to A and B parameters. When Intensity is set to +99, a ramp of 50 changes the filter frequency by 1 octave for every octave of the keyboard, and a ramp of +99 changes the frequency by 2 octaves for every octave of the keyboard.

+Inf and −Inf are special settings which create abrupt changes for split-like effects. When a ramp is set to +Inf or −Inf, the keyboard tracking will go to its extreme highest or lowest value over the span of a single key.

For more detailed explanations, please see “3-2a: Keyboard Track,” on page 65

Bottom-Low [−Inf, −99...+99, +Inf]

This sets the slope between the bottom of the MIDI note range and the Low Break key. For normal key track, use negative values.

Low-Center [−Inf, −99...+99, +Inf]

This sets the slope between the Low Break and Center keys. For normal key track, use negative values.

Center-High [−Inf, −99...+99, +Inf]

This sets the slope between the Center and High Break keys. For normal key track, use positive values.

High-Top [−Inf, −99...+99, +Inf]

This sets the slope between the High Break key and the top of the MIDI note range. For normal key track, use positive values.

Key Follow

To create the classic Key Follow effect, in which the filter frequency tracks the pitch of the keyboard:

1. **Set the Filter Frequency to 30.**
2. **Set the Keyboard Track Intensity to +99.**
3. **Set the Bottom-Low and Low-Center ramps to -50.**
4. **Set the Center-High and High-Top ramps to +50.**
5. **Set the Center Key to C4.**

The settings for the Low Break and High Break keys don't matter in this case.

5-3b: Filter EG

The EGs modulate the Filter A and B cutoff frequencies over time. You can control how strongly they will affect the filters in three different ways:

- Set an initial amount of EG modulation, using the EG Intensity parameters.
- Use velocity to scale the amount of the EG applied to the filter.
- Use any AMS source to scale the amount of the EG applied to the filter.

You can use all three of these at once, and the results are added together to produce the total EG effect.

To set up the EGs themselves, including attack and release times, levels, and so on, see “7-1: EG 1 (Filter),” on page 169.

Filter A

EG Select [EG 1 (Filter), EG 2 (Pitch), EG 3, EG 4, Amp EG]

This selects an EG to modulate Filter A's Frequency.

There are four assignable EGs, in addition to the Amp EG. Each of these can be used as a modulation source to control a wide variety of parameters.

In the midst of all this flexibility, we thought it would also be good to provide a little structure. With this in mind, EG 1 is named EG 1 (Filter) and EG 2 is labeled EG 2 (Pitch).

Please take these names as suggestions, rather than restrictions. If you like, you're free to use these EGs to control any EG or AMS destination, or to use other EGs to control Filter Frequency and Pitch.

Velocity Intensity [−99...+99]

This lets you use velocity to scale the amount of the EG applied to Filter A.

EG Intensity [−99...+99]

This controls the initial effect of the EG on Filter A's cutoff frequency, before any velocity or AMS modulation.

AMS [List of AMS Sources]

This selects an AMS modulation source to scale the amount of the EG applied to Filter A.

For a list of AMS sources, see “Alternate Modulation Source (AMS) List” on page 903.

Intensity **[-99...+99]**

This controls the depth and direction of the AMS modulation.

Filter B

The EG parameters for Filter B are the same as those for “Filter A,” above.

When **Link** is **On**, or when the Filter Routing is set to **Single** or **24dB (4-Pole)**, all of these parameters are grayed out.

5-3c: Filter Modulation

Filter A Frequency

AMS 1 **[List of AMS Sources]**

This selects the first modulation source to control Filter A’s **Frequency**. For a list of AMS sources, see “Alternate Modulation Source (AMS) List” on page 903.

Intensity **[-99...+99]**

This controls the depth and direction of the **Frequency** modulation.

Intensity Mod AMS **[List of AMS Sources]**

This selects an AMS source to modulate the intensity of **AMS 1**.

Intensity **[-99...+99]**

This controls the depth and direction of the **Intensity Mod AMS**.

AMS 2 **[List of AMS Sources]**

This selects a second modulation source to control Filter A’s **Frequency**. For a list of AMS sources, see “Alternate Modulation Source (AMS) List” on page 903.

Intensity **[-99...+99]**

This controls the depth and direction of **AMS 2**.

Filter B Frequency

The settings for Filter B are the same as those for “Filter A Frequency,” above.

When **Link** is **On**, or when the Filter Routing is set to **Single** or **24dB (4-Pole)**, all of these parameters are grayed out.

✓ 5-3: Page Menu Commands

- Compare →p.112

- Write Program →p.112
- Exclusive Solo →p.113

- PAGE →p.126
- MODE →p.126

5-4: Filter LFO Mod.

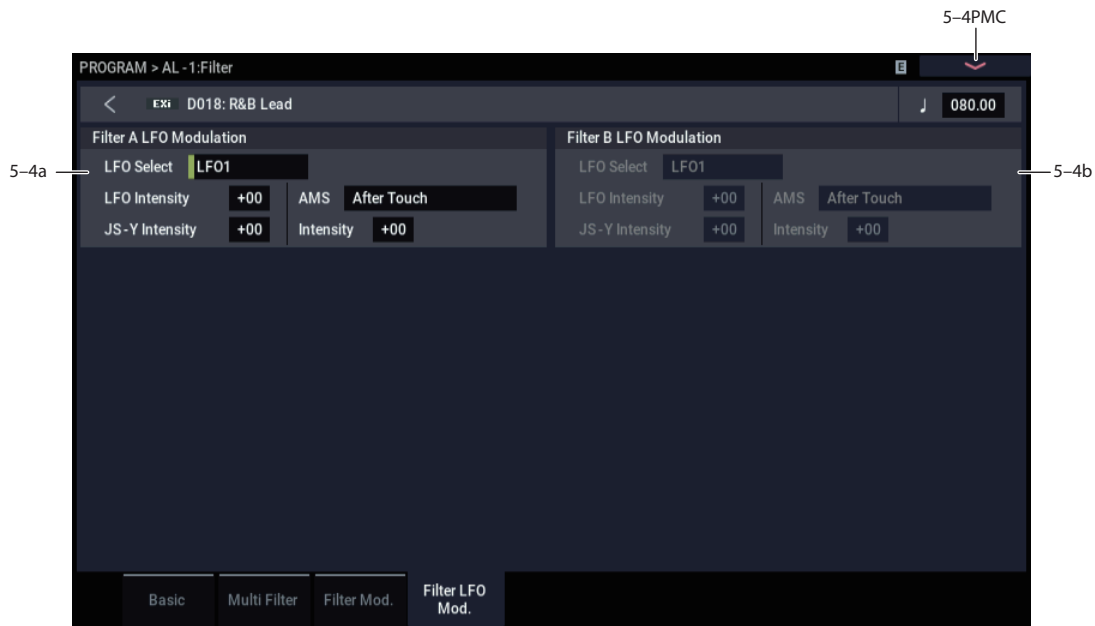

There are three LFO-to-Frequency controls for each filter: a basic amount (**LFO Intensity**), joystick -Y control of LFO amount (**JS- Y Intensity**), and AMS control of LFO amount (**AMS Intensity**). The three controls are summed together to determine the final LFO amount.

5-4a: Filter A

LFO Select [LFO 1, LFO 2, LFO 3, LFO 4, Common LFO]

This selects an LFO to modulate Filter A's cutoff frequency.

The **LFO Intensity**, **JS -Y Intensity**, and **AMS** are all summed together to produce the final amount of LFO pitch modulation.

LFO Intensity [-99...+99]

This controls the initial effect of the LFO on Filter A's cutoff frequency, before any JS+Y or AMS modulation.

Negative (-) settings will invert the phase of the LFO.

JS -Y Intensity [-99...+99]

Moving the joystick "down" from the center detent position, towards yourself, produces the JS -Y controller. You can use this to scale the amount of the LFO applied to Filter A.

This parameter sets the maximum amount of LFO modulation added by JS -Y.

AMS [List of AMS Sources]

This selects an AMS modulation source to scale the amount of the LFO applied to Filter A's cutoff frequency.

For a list of AMS sources, see "Alternate Modulation Source (AMS) List" on page 903.

Intensity [-99...+99]

This controls the depth and direction of the LFO AMS modulation.

5-4b: Filter B

The settings for Filter B are the same as those for "5-4a: Filter A," above.

When **Link** is **On**, or when the Filter Routing is set to **Single** or **24dB (4-Pole)**, all of these parameters are grayed out.

✓ 5-4: Page Menu Commands

- Compare →p.112
- Write Program →p.112
- Exclusive Solo →p.113
- PAGE →p.126
- MODE →p.126

PROGRAM > AL-1: Amp

These pages let you control the sound's volume (also called "amplitude," or "amp" for short), pan, and Drive, as well as its dedicated amp envelopes and keyboard tracking generators. For instance, you can:

- Set up the Driver circuit, which adds saturation and bass boost to the timbre.

- Set the pan position and pan modulation.
- Control amp level and modulation, including keyboard tracking, the amp envelope, LFO modulation, and AMS control.

6-1: Amp/Driver



This page controls the basic settings for the Amp section. Here, you can:

- Set up the Driver circuit.
- Set the initial volume level.
- Control the pan position and pan modulation.

6-1a: Driver

The Driver adds saturation and overdrive to the sound, for everything from subtle fattening to drastic distortion. Unlike an overdrive effect, the Driver processes each voice individually, so the timbre stays the same regardless of how many voices are being played.

The two main parameters, Drive and Low Boost, work together to create the overall Driver effect. Drive contributes edge and bite, and Low Boost provides the body as well as boosting the bass.

 Although the oscillators themselves have extremely low aliasing, the Driver can produce aliasing—especially at higher frequencies. If your goal is a completely pristine sound, set the Driver's **Bypass** to **On**. Otherwise, let it rip!

Bypass [Off, On]

When **Bypass** is **On**, the Driver is completely removed from the signal path.

Drive [0...99]

This controls the amount of edge and bite in the timbre. Low settings will produce mild saturation, and higher settings create more obvious distortion.

Often, it's useful to increase the **Low Boost** along with the **Drive**.

Note: Even when the **Drive** amount is set to 0, the Driver circuit still affects the timbre. If your goal is a completely pristine sound, use the **Bypass** control instead.

AMS [List of AMS Sources]

This selects an AMS modulation source to control the **Drive** amount. For a list of AMS sources, see "Alternate Modulation Source (AMS) List" on page 903.

Intensity [-99...+99]

This controls the depth and direction of the AMS modulation for **Drive**.

Low Boost [0...99]

This low-frequency EQ controls the body character of the sound. The specific EQ frequencies affected will change with the **Drive** setting.

Higher amounts increase the bass boost, and will also intensify the effect of the **Drive** parameter.

AMS [List of AMS Sources]

This selects an AMS modulation source to control the **Low Boost** amount. For a list of AMS sources, see “Alternate Modulation Source (AMS) List” on page 903.

Intensity [-99...+99]

This controls the depth and direction of the AMS modulation for **Low Boost**.

6-1b: Amp Level**Amp Level** [0...127]

This controls the basic volume level of the AL-1, before keyboard tracking, velocity, and other modulation.

MIDI and volume

MIDI You can control the Program’s overall volume via MIDI using both Volume (CC#7) and Expression (CC#11). When used one at a time, the two controllers work in exactly the same way: a MIDI value of 127 is equal to the Amp Level setting, and lower values reduce the volume.

If both CC#7 and CC#11 are used simultaneously, the one with the *lower* value determines the maximum volume, and the one with the higher value scales down from that maximum.

This is controlled on the global MIDI channel (GLOBAL 1-1a).

6-1c: Pan**Pan** [Random, L001...C064...R127]

This controls the stereo pan of the EXi. A setting of **L001** places the sound at the far left, **C064** in the center, and **R127** to the far right.

When **Filter Routing** is set to **Parallel**, the two filters can be panned separately (see “Pan” on page 156) and the AL-1 can create a stereo output. In this case, **Pan** steers the stereo image while maintaining the relative volumes of the AL-1’s left and right outputs. For instance, as you move **Pan** to the right of center, the AL-1’s left output will start to move to the right side, until at **R127** both the left and right outputs sound entirely in the right channel.

When this is set to **Random**, the pan position will be different for each note-on.

MIDI You can also control pan via MIDI Pan (CC#10). A CC#10 value of 0 or 1 places the sound at the far left, 64 places the sound at the location specified by the **Pan** parameter, and 127 places the sound at the far right. This is controlled on the global MIDI channel (GLOBAL 1-1a).

Note: You can select Random pan only from the on-screen UI, and not from MIDI.

AMS [List of AMS Sources]

This selects an AMS source to modulate **Pan**. For a list of AMS sources, see “Alternate Modulation Source (AMS) List” on page 903.

Intensity [-99...+99]

This controls the depth and direction of the AMS modulation for **Pan**.

For example, if **Pan** is set to C064 and **AMS** is set to Note Number, **positive (+)** intensities will cause the sound to move toward the right as you play higher than C4, and toward the left as you play lower than C4.

Negative (-) intensities will have the opposite effect.

✓ 6-1: Page Menu Commands

- Compare →p.112
- Write Program →p.112
- Exclusive Solo →p.113
- PAGE →p.126
- MODE →p.126

6-2: Amp Mod.



This page contains the settings for Oscillator 1's Amp level modulation. Among other things, you can:

- Set up complex keyboard tracking shapes to control the Amp level.
- Assign AMS modulation for the Amp level.
- Control the effect of the LFOs on the Amp level.

The total effects of the modulation can increase the volume to a maximum of two times louder than the Amp Level setting.

6-2a: Keyboard Track AMSSource

Keyboard tracking lets you vary the volume as you play up and down the keyboard. Usually, some amount of key tracking is necessary in order to make the volume consistent across the entire range.

The AL-1's Amp keyboard tracking parameters are identical to the HD-1's. In both cases, the Amp keyboard tracking works somewhat differently from the Filter and Common keyboard tracking. For more detailed explanations of the parameters, please see "4-2a: Keyboard Track," on page 76.

There is one difference between the two, however: the AL-1's Amp tracking is affected by Portamento, so that it changes smoothly during glides.

Key

Low Break [C-1...G9]

This sets the breakpoint note between the two lower ramps.

Center [C-1...G9]

This sets the center of the keyboard tracking. At this key, the keyboard tracking has no effect on the volume, or on any AMS destinations.

High Break [C-1...G9]

This sets the breakpoint note between the two higher ramps.

Ramp

Bottom-Low [-Inf, -99...+99, +Inf]

This sets the slope between the bottom of the MIDI note range and the Low Break key. For normal key track, use negative values.

| Ramp | Change in level |
|------|--------------------------|
| -Inf | Silent in one half-step |
| -99 | Silent in one whole-step |
| -95 | Silent in one octave |
| -48 | Silent in two octaves |
| -25 | Silent in four octaves |
| 00 | no change |
| +25 | x2 in four octaves |
| +50 | x2 in two octaves |
| +99 | x2 in one octave |
| +Inf | x2 in one half-step |

Low-Center [-Inf, -99...+99, +Inf]

This sets the slope between the Low Break and Center keys. For normal key track, use negative values.

Center-High [-Inf, -99...+99, +Inf]

This sets the slope between the Center and High Break keys. For normal key track, use positive values.

High-Top [-Inf, -99...+99, +Inf]

This sets the slope between the High Break key and the top of the MIDI note range. For normal key track, use positive values.

6-2b: Amp Modulation

You can modulate the Amp level by velocity and two AMS sources. Each of the AMS sources also has its own secondary intensity modulation.

This modulation scales the basic Amp level and Amp EG level parameters. If these original levels are low, the maximum volume available with modulation will also be reduced.

Note that there is an upper limit to Amp modulation. Once the volume level reaches double the programmed Amp Level and Amp EG level settings, it cannot be increased any further.

Velocity Intensity [-99...+99]

With **positive (+)** values, the volume will increase as you play harder.

With **negative (-)** values, the volume will decrease as you play harder.

AMS1 [List of AMS Sources]

This selects the first modulation source for the Amp level. For a list of AMS sources, see “Alternate Modulation Source (AMS) List” on page 903.

Intensity [-99...+99]

This sets the initial amount of AMS1. The **Intensity Mod AMS** then adds to this initial amount.

Intensity Mod AMS [List of AMS Sources]

This selects a secondary AMS modulation source to scale the intensity of AMS1.

For a list of AMS sources, see “Alternate Modulation Source (AMS) List” on page 903.

Intensity [-99...+99]

This controls the depth and direction of the **Intensity Mod AMS**. Even if the main AMS1 Intensity is set to 0, Intensity Mod AMS can still control the final amount of AMS A over the full +/-99 range.

For example, if AMS1 is set to LFO1, and **Intensity Mod AMS** is set to JS + Y,

For example, if AMS1 is set to the **Pitch EG**, and **Intensity Mod AMS** is set to JS + Y, positive settings mean that pushing the joystick away from yourself will increase the intensity of the LFO modulation of Amp.

AMS2 [List of AMS Sources]

This selects a second modulation source for the Amp level. For a list of AMS sources, see “Alternate Modulation Source (AMS) List” on page 903.

Intensity [-99...+99]

This sets the initial amount of AMS2. The **Intensity Mod AMS** then adds to this initial amount.

Intensity Mod AMS [List of AMS Sources]

This selects a secondary AMS modulation source to scale the intensity of AMS2.

For a list of AMS sources, see “Alternate Modulation Source (AMS) List” on page 903.

Intensity [-99...+99]

This controls the depth and direction of the **Intensity Mod AMS**. Even if the main AMS2 **Intensity** is set to 0, **Intensity Mod AMS** can still control the final amount of AMS A over the full +/-99 range.

✓ 6-2: Page Menu Commands

- Compare →p.112
- Write Program →p.112
- Exclusive Solo →p.113
- PAGE →p.126
- MODE →p.126

6-3: Amp EG AMSource

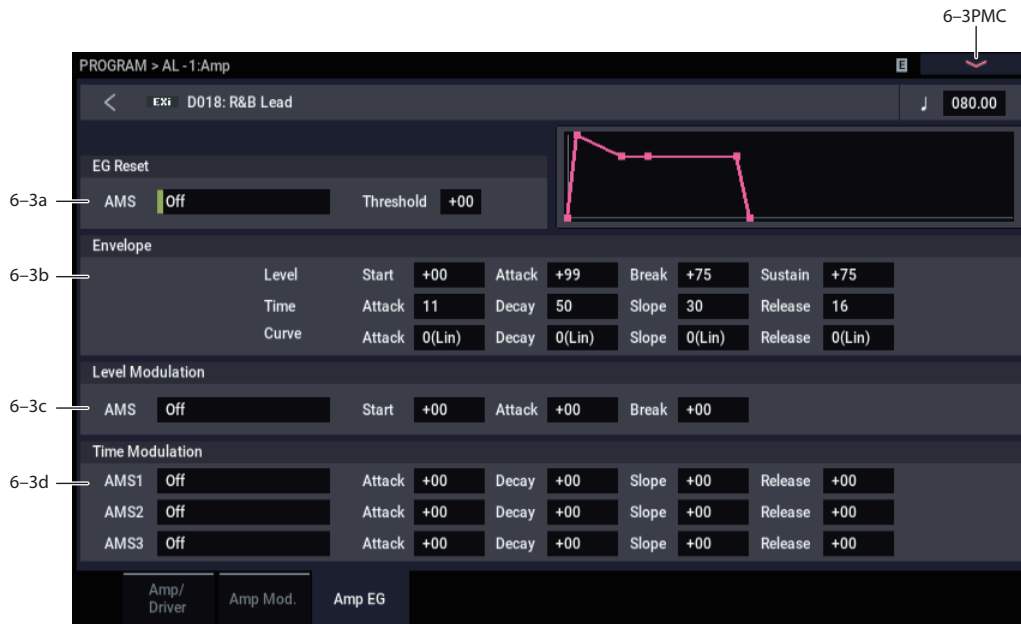

The AL-1's Amp EG is identical to the HD-1's. For more detailed explanations of the Amp EG features, please see "4-3: Amp1 EG," on page 79.

Other envelopes can be used as additional controls via AMS, if desired.

6-3a: EG Reset

AMS [List of AMS Sources]

This selects an AMS source to reset the EG to the start point. For instance, you can use a tempo-synced LFO to trigger the EG in a repeating rhythm. This reset is in addition to the initial note-on, which always causes the EG to start.

Note: Once the Amp EG is in its Release segment, it cannot be reset. (Otherwise, the sound might keep playing forever!)

For a list of AMS sources, see "Alternate Modulation Source (AMS) List" on page 903.

Threshold [−99...+99]

This sets the AMS level which will trigger the EG reset. Among other things, you can use this to adjust the exact point in an LFO's phase at which the EG will be reset, effectively controlling its "groove" against other rhythmic effects.

When the threshold is **positive**, the EG triggers when passing through the threshold moving upwards. When the threshold is **negative**, the EG triggers when passing through the threshold moving downwards.

Note: With some LFO shapes, and with faster LFO speeds, the LFO may not always reach the extreme values of +99 or -99. In this case, setting the **Threshold** to these values may cause inconsistent behavior, or may mean that the EG doesn't reset at all. If this happens, reduce the **Threshold** until the EG triggers consistently.

6-3b: Envelope

These parameters specify how the amp EG will change over time.

Amp EG

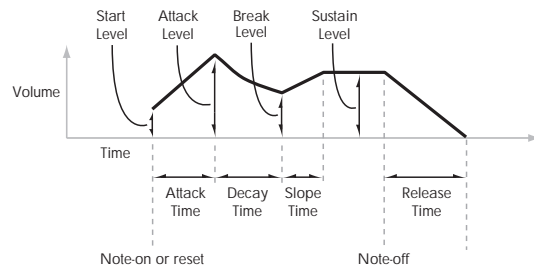

Level

Start [00...99]

This sets the initial volume level at note-on.

Attack [00...99]

This sets the level at the end of the Attack time.

Break [00...99]

Break, short for Break Point, sets the level at the end of the Decay time.

Sustain [00...99]

This sets the level at the end of the Slope time. Once it reaches the Sustain level, the EG will stay there until note-off (unless it is reset via AMS).

Time

Higher values mean longer times. For a chart showing equivalents in milliseconds, please see "Time" on page 80.

Attack [00...99]

This sets how long the EG takes to move from the Start level to the Attack level.

The minimum attack time is 2/3 of a millisecond—as fast as the most punchy of classic analog synths.

For the fastest possible attack time, you can set the Start level to +99; in this case, the EG will start instantaneously at its maximum value.

Decay [00...99]

This sets the time it takes to move from the Attack level to the Break level.

Slope [00...99]

This sets how long the EG takes to move from the Break level to the Sustain level. Once it reaches the Sustain level, the EG will stay there until note-off (unless it is reset via AMS).

Release [00...99]

This sets how long it takes the EG to move from the Sustain level to silence.

Curve

Classic analog synth envelopes created curved shapes naturally. The NAUTILUS goes a step further than vintage synths, however, and lets you control the amount of curvature separately for each of the four envelope segments.

When you change the curvature, the EG times remain the same. However, greater curvature will tend to *sound* faster, because the value changes more quickly at the beginning.

You may find that different amounts of curvature are suitable for segments which go up and segments which go down.

For instance, a curve of 3 is a good default setting for upward segments, such as Attack. On the other hand, a curve of 6 or more is good for downward segments, such as Decay and Release.

Attack [0 (Linear), 1...9, 10 (Exp/Log)]

This sets the curvature of the Attack segment - the transition from the Start level to the Attack level.

Decay [0 (Linear), 1...9, 10 (Exp/Log)]

This sets the curvature of the Decay segment - the transition from the Attack level to the Break level.

Slope [0 (Linear), 1...9, 10 (Exp/Log)]

This sets the curvature of the Slope segment - the transition from the Break level to the Sustain level.

Release [0 (Linear), 1...9, 10 (Exp/Log)]

This sets the curvature of the Release segment - the transition from the Sustain level to the Release level.

6-3c: Level Modulation

These settings let you use an AMS source to control the Level parameters of the EG. The Start, Attack, and Break levels share a single AMS source, but can each have different modulation intensities.

Note: Once the EG has started a segment between two points, that segment can no longer be modulated. For instance, if the EG is in the middle of the Decay time, you can no longer modulate either the Decay time or the Break level.

This also means that modulating the Start level, Attack level, or Attack time will not affect notes that are already sounding, unless the EG is then reset via AMS.

AMS [List of AMS Sources]

This selects an AMS source to control the EG's Level parameters.

For a list of AMS sources, see "Alternate Modulation Source (AMS) List" on page 903.

Start [-99...+99]

This controls the depth and direction of the AMS modulation for the Start level.

Attack [-99...+99]

This controls the depth and direction of the AMS modulation for the Attack level.

Break [-99...+99]

This controls the depth and direction of the AMS modulation for the Break level.

6-3d: Time Modulation

These settings let you use three different AMS sources to control the Time parameters of the EG. For each of the three AMS sources, the Attack, Decay, Slope, and Release times each have their own modulation intensities.

AMS1 [List of AMS Sources]

Selects the first AMS source to control the EG's Time parameters. Velocity and Keyboard Track can both be useful here, for instance.

For a list of AMS sources, see "Alternate Modulation Source (AMS) List" on page 903.

Attack [-99...+99]

This controls the depth and direction of the AMS modulation for the Attack time.

When the AMS source is at its maximum value—for instance, when Velocity is at 127—a setting of +8 will make the segment time almost twice as long, and a setting of -8 will cut the segment time almost in half.

Decay [-99...+99]

This controls the depth and direction of the AMS modulation for the Decay time.

Slope [-99...+99]

This controls the depth and direction of the AMS modulation for the Slope time.

Release [-99...+99]

This controls the depth and direction of the AMS modulation for the Release time.

AMS2 and AMS3

These select the second and third AMS sources, respectively, for controlling the EG's Time parameters. Each has its own intensities for Attack, Decay, Slope, and Release. The parameters of both AMS2 and AMS 3 are identical to those of AMS1, above.

▼ 6-3: Page Menu Commands

- Compare →p.112
- Write Program →p.112
- Exclusive Solo →p.113
- Copy Envelope →p.182
- Swap Envelope →p.182

- PAGE →p.126
- MODE →p.126

PROGRAM > AL-1: EG 1-4

There are four assignable EGs, in addition to the Amp EG. Each of these can be used as an AMS modulation source to control a wide variety of parameters.

There are also four parameters with dedicated EG modulation inputs: Pitch for Oscillators 1 and 2, and Frequency for Filters A and B. Any of the four EGs can be used for these modulation routings.

In the midst of all this flexibility, we thought it would also be good to provide a little structure. With this in mind, EG 1 is named EG 1 (Filter) and EG 2 is labeled EG 2 (Pitch).

Please take these names as suggestions, rather than restrictions. If you like, you're free to use these EGs to control any EG or AMS destination, or to use other EGs to control Filter Frequency and Pitch.

7-1: EG 1 (Filter) AMSource

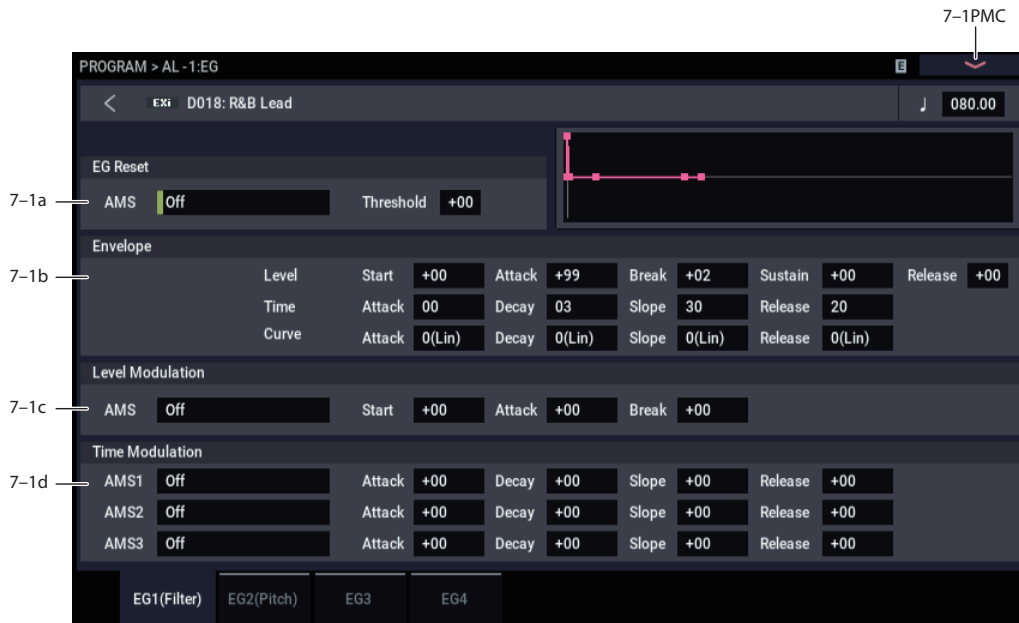

The EGs, or Envelope Generators, let you create complex, time-varying changes to AMS-modulatable parameters. The controls on this page specify the shape of the EG. Among other things, you can:

- Create the basic EG shape by setting the levels and times of each segment.
- Control the curvature of each EG segment, for subtle control over the sound of the EG.
- Set up complex modulation of EG levels and times.
- Set up an AMS source, such as an LFO, to restart the EG.

One thing that you can't do on this page is to control how much effect the EG has on the parameters it modulates. To do that, you'll need to adjust the AMS intensities on the pages for the individual parameters.

7-1a: EG Reset

AMS

[List of AMS Sources]

This selects an AMS source to reset the EG to the start point. For instance, you can use a tempo-synced LFO to trigger the EG in a repeating rhythm. This reset is in addition to the initial note-on, which always causes the EG to start.

For a list of AMS sources, see “Alternate Modulation Source (AMS) List” on page 903.

Threshold

[-99...+99]

This sets the AMS level which will trigger the EG reset. Among other things, you can use this to adjust the exact point in an LFO's phase at which the EG will be reset, effectively controlling its “groove” against other rhythmic effects.

When the threshold is **positive**, the EG triggers when passing through the threshold moving upwards. When the threshold is **negative**, the EG triggers when passing through the threshold moving downwards.

Note: with some LFO shapes, and with faster LFO speeds, the LFO may not always reach the extreme values of +99 or -99. In this case, setting the **Threshold** to these values may cause inconsistent behavior, or may mean that the EG doesn't reset at all. If this happens, reduce the **Threshold** until the EG triggers consistently.

7-1b: Envelope

EG

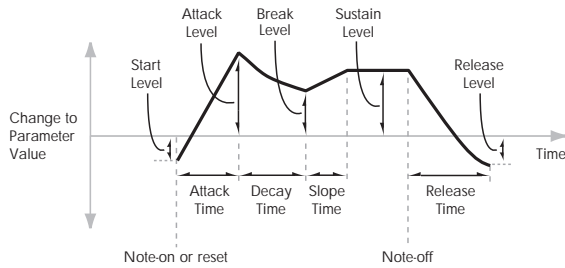

Envelopes create a modulation signal by moving from one level to another over a specified time, and then moving to another level over another period of time, and so on.

The parameters below let you set five levels, the amount of time it takes to go from each of the levels to the next, and the shape (from linear to curved) of each transition.

Level

Each of the five levels can be either positive or negative.

Positive levels will make the cutoff frequency (or other AMS destination) go up from its programmed value; **negative** levels will make it go down.

Start [-99...+99]

This sets the initial EG level, at note-on.

Attack [-99...+99]

This sets the level at the end of the Attack time.

Break [-99...+99]

Break, short for Break Point, sets the level at the end of the Decay time.

Sustain [-99...+99]

This sets the level at the end of the Slope time. Once it reaches the Sustain level, the EG will stay there until note-off, unless it is reset via AMS.

Release [-99...+99]

This sets the level at the end of the Release time.

Time

Higher values mean longer times, as shown below:

| EG Value | Actual Time |
|----------|--------------|
| 00 | 0.667 ms |
| 10 | 10 ms |
| 20 | 44 ms |
| 30 | 104 ms |
| 40 | 224 ms |
| 50 | 464 ms |
| 60 | 944 ms |
| 70 | 1.8 seconds |
| 80 | 3.8 seconds |
| 90 | 10.9 seconds |
| 99 | 87.3 seconds |

Attack [00...99]

This sets how long the EG takes to move from the Start level to the Attack level.

The minimum attack time is 2/3 of a millisecond—as fast as the most punchy of classic analog synths.

For the fastest possible attack time, you can set the Start level to +99; in this case, the EG will start instantaneously at its maximum value.

Decay [00...99]

This sets the time it takes to move from the Attack level to the Break level.

Slope [00...99]

This sets how long the EG takes to move from the Break level to the Sustain level. Once it reaches the Sustain level, the EG will stay there until note-off (unless it is reset via AMS).

Release [00...99]

This sets how long it takes the EG to move from the Sustain level to the Release level.

Curve

For the sake of simplicity, most of the diagrams in this manual show envelopes as being made out of straight lines. In actuality, though, envelopes are more likely to be made out of curves.

In other words, each segment's level will change quickly at first, and then slow down as it approaches the next point. This tends to sound better than straight, linear segments.

Classic analog synth envelopes made these curved shapes naturally. The NAUTILUS goes a step further than vintage synths, however, and lets you control the amount of curvature separately for each of the four envelope segments.

When you change the curvature, the EG times remain the same. However, greater curvature will tend to *sound* faster, because the value changes more quickly at the beginning.

Different curve settings for up and down

You may find that different amounts of curvature are suitable for segments which go up and segments which go down.

For instance, a curve of 3 is a good default setting for upward segments, such as Attack. On the other hand, a curve of 6 or more is good for downward segments, such as Decay and Release.

EG Curve

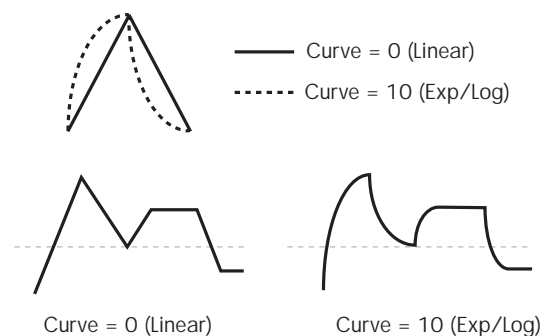

Attack [0 (Linear), 1...9, 10 (Exp/Log)]

This sets the curvature of the Attack segment - the transition from the Start level to the Attack level.

Decay [0 (Linear), 1...9, 10 (Exp/Log)]

This sets the curvature of the Decay segment - the transition from the Attack level to the Break level.

Slope [0 (Linear), 1...9, 10 (Exp/Log)]

This sets the curvature of the Slope segment - the transition from the Break level to the Sustain level.

Release [0 (Linear), 1...9, 10 (Exp/Log)]

This sets the curvature of the Release segment - the transition from the Sustain level to the Release level.

7-1c: Level Modulation

These settings let you use an AMS source to control the Level parameters of the EG. The Start, Attack, and Break levels share a single AMS source, but can each have different modulation intensities.

By using different settings for each of the three levels, you can cause both subtle and dramatic changes to the EG shape, as shown below.

EG Level Modulation

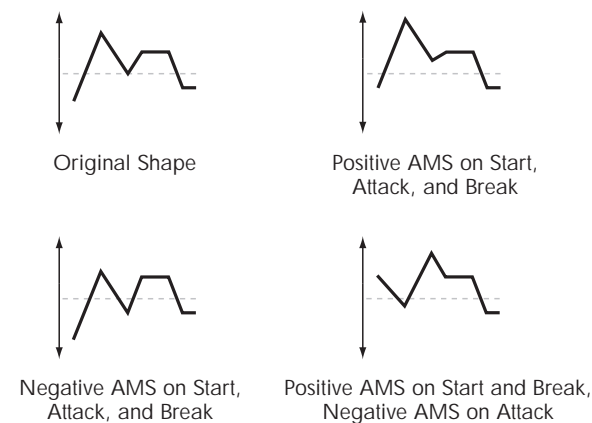

Once an EG segment begins, it can't be modulated

Once the EG has started a segment between two points, that segment can no longer be modulated. This includes both the time of the segment, and the level reached at the end of the segment.

For instance, if the EG is in the middle of the Decay time, you can no longer modulate either the Decay time or the Break level.

As another example, let's say that you've assigned the Common LFO to modulate Break Level. The LFO may be moving all the time, but the Break Level is only affected by the LFO's value at the instant that the Decay segment starts. After that, the level is fixed.

Finally, this also means that modulating the Start level, Attack level, or Attack time will not affect notes that are already sounding, unless the EG is then reset via AMS.

AMS [List of AMS Sources]

This selects an AMS source to control the EG's Level parameters.

For a list of AMS sources, see "Alternate Modulation Source (AMS) List" on page 903.

Start [-99...+99]

This controls the depth and direction of the AMS modulation for the Start level.

For example, if you set the AMS source to Velocity and set Start to +99, the Start level will increase as you play harder. If you instead set Start to -99, the Start level will decrease as you play harder.

Attack [-99...+99]

This controls the depth and direction of the AMS modulation for the Attack level.

Break [-99...+99]

This controls the depth and direction of the AMS modulation for the Break level.

7-1d: Time Modulation

These settings let you use three different AMS sources to control the Time parameters of the EG. For each of the three AMS sources, the Attack, Decay, Slope, and Release times each have their own modulation intensities.

EG Time Modulation

AMS=Velocity, Intensity = a positive (+) value

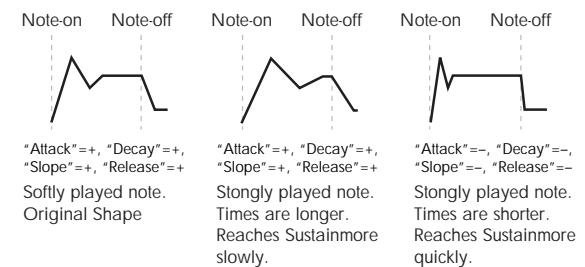

AMS1 [List of AMS Sources]

Selects the first AMS source to control the EG's Time parameters. Velocity and Keyboard Track can both be useful here, for instance.

For a list of AMS sources, see "Alternate Modulation Source (AMS) List" on page 903.

Attack [-99...+99]

This controls the depth and direction of the AMS modulation for the Attack time.

When the AMS source is at its maximum value—for instance, when Velocity is at 127—a setting of +8 will make the segment time almost twice as long, and a setting of -8 will cut the segment time almost in half.

For example, if you set the AMS source to Velocity and set Attack to +99, the Attack time will get much longer at higher velocities. If you instead set Attack to -99, the Attack time will get much shorter at higher velocities.

Decay [-99...+99]

This controls the depth and direction of the AMS modulation for the Decay time.

Slope [-99...+99]

This controls the depth and direction of the AMS modulation for the Slope time.

Release

[−99...+99]

This controls the depth and direction of the AMS modulation for the Release time.

AMS2 and AMS3

These select the second and third AMS sources, respectively, for controlling the EG's Time parameters. Each has its own intensities for Attack, Decay, Slope, and Release. The parameters of both AMS2 and AMS 3 are identical to those of AMS1, above.

✓ 7-1: Page Menu Commands

- Compare →p.112
- Write Program →p.112
- Exclusive Solo →p.113
- Copy Envelope →p.182
- Swap Envelope →p.182
- PAGE →p.126
- MODE →p.126

7-2: EG 2 (Pitch) AMSource

7-3: EG 3 AMSource

7-4: EG 4 AMSource

The settings for EGs 2-4 are identical to those for EG1. For more information, see “7-1: EG 1 (Filter)” on page 169.

PROGRAM > AL-1: Step Seq/LFO

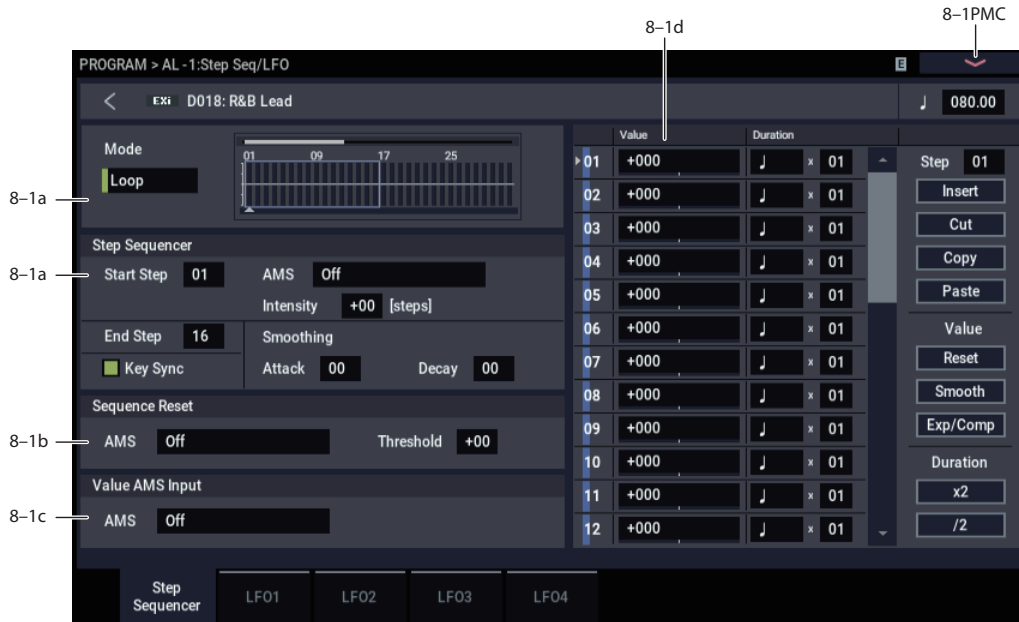
8-1: Step Sequencer AMSource

Overview

The Step Sequencer creates complex, rhythmic patterns, for use as an AMS modulation source. For instance, you can modulate a filter to create sample-and-hold effects, modulate pitch to create melodic patterns, or modulate amplitude to create pulsing, triggered-gate effects.

Each voice of the AL-1 has its own Step Sequencer, in addition to the Common Step Sequencer shared by both EXi instruments. To make all of the per-voice Step Sequencers run in sync, set **Key Sync** to **Off**.

The sequence can have up to 32 steps, each with its own level and duration. It can loop, or play only once. You can also:

- Re-start the Step Sequencer via AMS
- Modulate the Start Step via AMS
- Use individual steps to either gate or do sample-and-hold on a continuous AMS source, such as an EG or LFO
- Assign individual steps to create a random level
- Use Smoothing to create gentle, curving shapes

Step Sequencer usage tips

For some tips on using the Step Sequencer, see:

- “Creating melodic patterns with the Step Sequencer” on page 136
- “Using Smoothing to create envelope-like shapes” on page 137
- “Using Smoothing to make step transitions more gentle” on page 137

8-1a: Step Sequencer

Mode [Loop, One Shot]

Loop makes the Step Sequence loop continuously between the **Start Step** and the **End Step**.

One Shot makes the Step Sequence play once from the **Start Step** to the **End Step**, and then hold at the **End Step**. You can still reset the Step Sequencer from AMS to make it play again.

Start Step [1...32]

This is the step on which the sequence will start. If **Mode** is set to **Loop**, this also sets the start of the loop.

AMS [List of AMS Sources]

This selects an AMS source to modulate the **Start Step**. For a list of AMS sources, see “Alternate Modulation Source (AMS) List” on page 903.

Intensity [-32...+32]

This controls the depth and direction of the **Start Step** modulation.

End Step [01...32]

This sets the last step in the sequence. Once the sequence reaches the **End Step**, it will either hold there until the note goes away (if **Mode** is set to **One Shot**), or loop back to the **Start Step** (if **Mode** is set to **Loop**).

Key Sync [Off, On]

When **Key Sync** is **On**, each note’s Step Sequencer is independent, and the sequence always starts from the **Start Step** at note-on.

When **Key Sync** is **Off**, the Step Sequencers for all notes are synchronized together (unless the **Start Step** is modulated by note-specific AMS sources). The first note in a legato phrase will start from the **Start Step**; subsequent notes will play in sync with that first note.

Smoothing

These controls filter the Step Sequencer's output signal, creating more gentle transitions between values. You can use this to round off the hard edges of the Step Sequencer's output, or to create envelope-like effects.

You have separate control of the amount of smoothing during the attack (when the signal is increasing) and decay (when it's decreasing).

For more information, see "Using Smoothing to create envelope-like shapes" on page 137, and "Using Smoothing to make step transitions more gentle" on page 137.

Attack [00...99]

This controls the attack time of the smoother, or how long it takes to reach a new, *higher* value.

Higher **Attack** settings mean longer times.

Depending on how quickly the Step Sequencer value is changing, high **Attack** settings may mean that a new value is never quite reached.

Decay [00...99]

This controls the decay time of the smoother, or how long it takes the smoother to reach a new, *lower* value.

Higher **Decay** settings mean longer times.

8-1b: Sequencer Reset

AMS [List of AMS Sources]

This selects an AMS source to reset the sequence to the **Start Step**.

Threshold [-99...+99]

This sets the AMS level which will make the Step Sequencer reset. Among other things, you can use this to adjust the exact point in an LFO's phase at which the sequencer will be reset, effectively controlling its "groove" against other rhythmic effects.

When the threshold is **positive**, the Step Sequencer triggers when passing through the threshold moving upwards. When the threshold is **negative**, the Step Sequencer triggers when passing through the threshold moving downwards.

Note: With some LFO shapes, and with faster LFO speeds, the LFO may not always reach the extreme values of +99 or -99. In this case, setting the **Threshold** to these values may cause inconsistent behavior, or may mean that the Step Sequencer doesn't reset at all. If this happens, reduce the **Threshold** until the Step Sequencer triggers consistently.

8-1c: Value AMS Input

AMS [List of AMS Sources]

This is the AMS source used for steps set to **AMS Input** or **AMS Input S/H**.

8-1d: Step Parameters

Each of the 32 steps has its own settings for Value and Duration.

Value 1-32 [-100...+100, Random, AMS Input, AMS Input S/H]

-100 through +100 generate specific levels, just as you'd expect.

Random yields a different, random value every time the step is played.

AMS Input uses the signal from the **Value AMS Input** source, above. This can change continuously over the duration of the step. For instance, if you used an LFO as the **Value AMS Input**, you'd hear the LFO move over the duration of the step.

AMS Input S/H grabs the level of the **Value AMS Input** source at the start of the step, and then maintains that single value for the duration of the step.

Duration (Base Note) 1-32 [♪...♩]

This sets the basic length of the step, relative to the system tempo. The values range from a 32nd note to a whole note, including triplets.

x (Multiply Base Note by...) 1-32 [01...32]

This multiplies the length of the Base Note. For instance, if the Base Note is set to a sixteenth note, and Times is set to 3, the step's duration will be a dotted eighth note.

Command buttons

Step

Step [01...32]

Selects the step that you want to edit.

Insert

Inserts the cut or copied step at the current step.

Cut

Cuts the current step. Subsequent steps will be moved forward. If desired, you can then paste or insert the cut step into another location.

Copy

Copies the current step. You can then paste or insert the copied step into another location.

Paste

Pastes the cut or copied step onto the current step, replacing it.

Value

Reset

Resets the "Value" of each step to 000.

Smooth

Automatically adjusts the "Value" of each step so that they are smoothly connected.

Exp/Comp

When you press the Exp/Comp button, the Step Sequence Value dialog box will appear. The value of each step will be expanded or compressed by the percentage (%) you specify.

Step Sequence Value dialog box



Expand/Compress [%]

[0...100]

If this is at 100%, the current value of each step will be used without change. If you check “Keep Proportion,” the % value will be limited so that the expansion/ compression will maintain the relationships between the current step settings.

Duration

x2

This doubles the duration of the steps or the “x (Multiply Base Note by...)” value. For example, it would turn eighth notes into quarter notes, and quarter notes into half notes.

/2

This halves the duration of the steps or the “x (Multiply Base Note by...)” value. For example, it would turn quarter notes into eighth notes, and eighth notes into sixteenth notes.

✓ 8-1: Page Menu Commands

- Compare →p.112
- Write Program →p.112
- Exclusive Solo →p.113
- Copy Step Sequencer →p.140
- PAGE →p.126
- MODE →p.126

8-2: LFO 1 AMSource

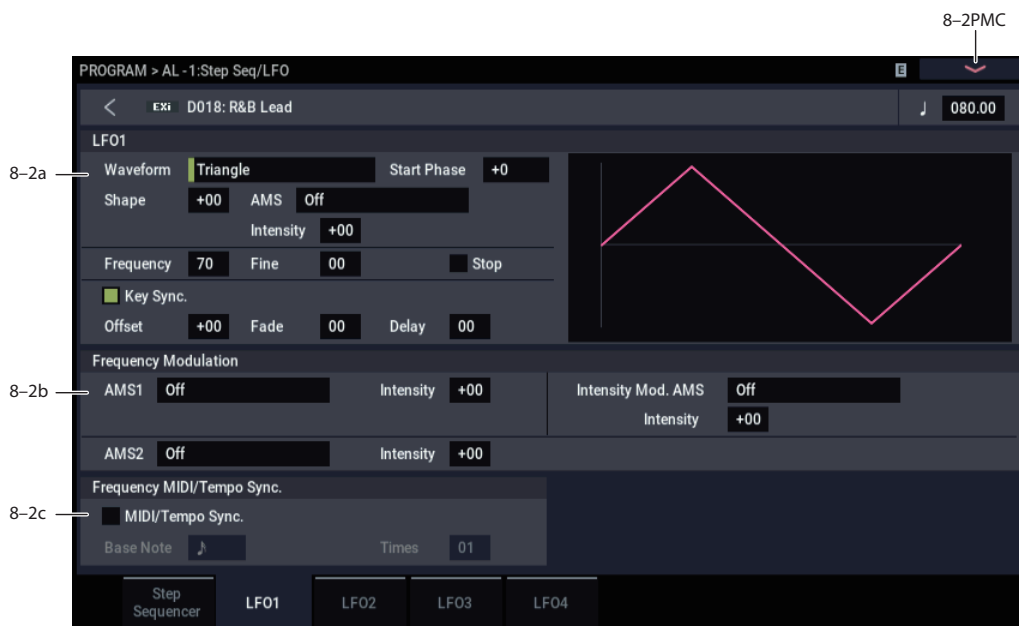

This page has all of the controls for the first LFO. For instance, you can:

- Select the LFO’s basic waveform, and modify it with the Shape parameter.
- Control the LFO’s frequency, and assign AMS controllers to modulate the frequency.
- Use the Key Sync parameter to choose whether the LFO runs separately for each voice, or is synchronized across all of the voices
- Use the Fade and Delay parameters to control how long the LFO waits to start after note-on, and whether it starts abruptly or fades in slowly.
- Set the LFO to sync to MIDI tempo.

8-2a: LFO 1

Waveform [Triangle...Random6 (Continuous)]

This selects the basic LFO waveform, as shown in the graphic below.

Most of the waveforms should be self-explanatory, but a few will benefit from more details:

Guitar is intended for guitar vibrato, and its shape is specifically tuned for this purpose. The waveform is positive-only, so that when used for pitch, it will only bend up, and not down.

Random1 (S/H) generates traditional sample and hold waveforms, in which the level changes randomly at fixed intervals of time.

Random2 (S/H) randomizes both the levels and the timing.

Random3 (S/H) generates a pulse wave with random timing. It's the opposite of traditional sample and hold; the timing varies, but the levels don't.

Random4-6 (Continuous) are smoothed versions of Random 1-3, with ramps instead of steps. You can use them to create more gentle random variations.

Start Phase [-180...+180, Random]

This controls the phase of the waveform at the start of the note, in steps of 5 degrees.

If **Key Sync** is On, the Start Phase will apply only to the first note of the phrase.

Shape [-99...+99]

Shape adds curvature to the basic waveform. As you can see in the graphic below, this can make the waveforms either more rounded or more extreme. It can also be useful to emphasize certain value ranges, and de-emphasize others.

For example, let's say that you are using a triangle LFO to modulate filter cutoff. If Shape emphasizes the high value range, the filter will spend more time at the higher frequencies. If it emphasizes the low range, the filter will spend more time at the lower frequencies.

LFO Shape

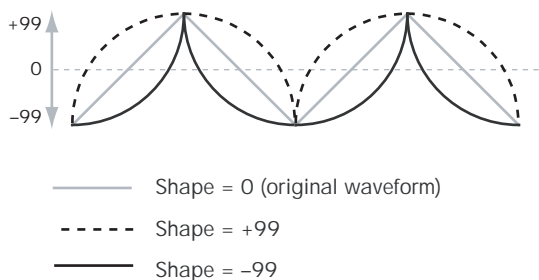

LFO Waveforms

| | | | | | | | | | |
|----------|--|----------------------|--|-----------------|--|---------------|--|----------------------|--|
| Triangle | | Guitar | | Step Triangle-4 | | Random1 (S/H) | | Random4 (Continuous) | |
| Saw | | Exponential Triangle | | Step Triangle-6 | | Random2 (S/H) | | Random5 (Continuous) | |
| Square | | Exponential Saw Down | | Step Saw-4 | | Random3 (S/H) | | Random6 (Continuous) | |
| Sine | | Exponential Saw Up | | Step Saw-6 | | | | | |

Note: Shape does **not** affect the Square and Random 3 waveforms, since their values are always either +99 or -99. When these are selected, Shape is grayed out.

AMS [List of AMS Sources]

This selects a modulation source for controlling the LFO's Shape. Modulating the shape can dramatically alter the effect of the LFO—try it out!

For a list of AMS sources, see “Alternate Modulation Source (AMS) List” on page 903.

Intensity [-99...+99]

This controls the depth and direction of the modulation.

Frequency [00...99]

This controls the speed of the LFO, before any modulation. Higher values mean faster speeds, as shown in the table below.

By using AMS modulation, you can also get speeds much faster and much slower than are available through this basic setting.

| Frequency Value | Frequency in Hz |
|-----------------|-----------------|
| 00 | 0.014 Hz |
| 10 | 0.112 Hz |
| 20 | 0.422 Hz |
| 30 | 0.979 Hz |
| 40 | 1.79 Hz |
| 50 | 2.84 Hz |
| 60 | 4.14 Hz |
| 70 | 5.69 Hz |
| 80 | 7.49 Hz |
| 90 | 9.53 Hz |
| 99 | 26.25 Hz |
| 99 + Fine 99 | 32 Hz |

Fine [00...99]

This allows you to control the LFO frequency with greater precision, giving you 98 additional steps for each step of the main Frequency parameter.

When this is set to 00, the LFO speed is as set by the Frequency parameter.

When this is set to 99, it's the same as increasing the main Frequency value by 1.

Stop [Off, On]

On (checked): When Stop is **On**, the LFO does not advance normally, and the Frequency parameters are ignored. Instead, the LFO simply generate its very first value (as

determined by the combination of the **Waveform**, **Start Phase**, **Shape**, and **Offset**, and then holds that value until the end of the note.

You can use this in conjunction with the Random waveforms to create static, random modulation, with the value changing only at note-on.

Off (unchecked): When Stop is **Off**, the LFO will function normally.

Key Sync [Off, On]

On (checked): When Key Sync is **On**, the LFO starts each time you press a key, and an independent LFO runs for each note. This is the normal setting.

Off (unchecked): When Key Sync is **Off**, the LFO starts from the phase determined by the first note in the phrase, so that the LFOs for all notes being held are synchronized together. The Fade and Delay settings will only apply to the first note's LFO.

Note that even if Key Sync is Off, each note's LFO speed may still be different if you modulate the Frequency by note number, velocity, key scaling, or other note-specific AMS sources.

Offset [-99...+99]

By default, almost all of the LFO waveforms are centered around 0, and then swing all the way from -99 to +99. This parameter lets you shift the LFO up and down, so that—for instance—it's centered on 50, and then swings from -49 to +149.

For example, let's say that you're using an LFO for vibrato. If the Offset is 0, the vibrato will be centered on the note's original pitch, bending it both up and down.

If the Offset is +99, on the other hand, the vibrato will only raise the pitch above the original note.

Offset settings and pitch change produced by vibrato

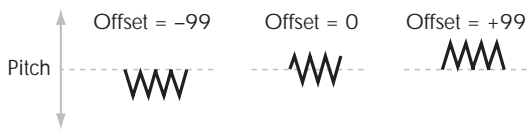

The one exception to this is the Guitar waveform, which is designed to emulate bending a string on a guitar—so that the pitch only goes up, and not down. Because of this, the waveform is centered on 50, and not on 0. Of course, you can always use a negative Offset to shift it back down below 0 again!

Since Offset affects the output values of the LFO, it's important to note that it affects the signal *after* the Shape function, as shown below:

LFO Signal Flow

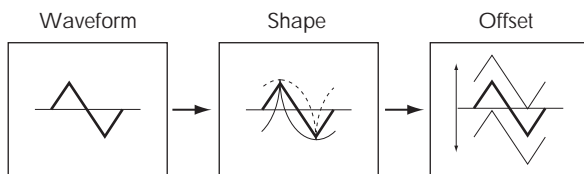

Fade [00...99]

The LFO can fade in gradually, instead of simply starting immediately at full strength. This parameter specifies the time from when the LFO begins to play until it reaches its maximum amplitude.

If the Delay parameter is being used, then the fade will begin after the delay is complete.

When **Key Sync** is **Off**, the fade will apply only to the first note in the phrase.

LFO Fade and Delay

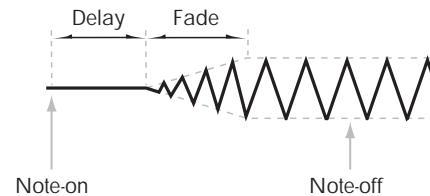

Delay [0...99]

This sets the time from note-on until the LFO starts.

When **Key Sync** is **Off**, the delay applies only to the first note of the phrase.

8-2b: Frequency Modulation

You can use two alternate modulation sources (AMS) to adjust the speed of the LFO.

AMS1 [List of AMS Sources]

This selects the first modulation source for the LFO frequency. For a list of AMS sources, see "Alternate Modulation Source (AMS) List" on page 903.

Note that you can use LFO2 to modulate LFO1's frequency.

Intensity [-99...+99]

This sets the initial amount of AMS1. The Intensity Mod AMS then adds to this initial amount.

When AMS1 is at its maximum value (for instance, when the joystick is pushed all the way up), the AMS affects the frequency as shown below:

| Intensity | Change to LFO Frequency | |
|-----------|-------------------------|--------|
| +99 | 64x | Faster |
| +82 | 32x | |
| +66 | 16x | |
| +49 | 8x | |
| +33 | 4x | |
| +16 | 2x | |
| -16 | 1/2x | Slower |
| -33 | 1/4x | |
| -49 | 1/8x | |
| -66 | 1/16x | |
| -82 | 1/32x | |
| -99 | 1/64x | |

Intensity Mod AMS [List of AMS Sources]

This selects a secondary AMS modulation source to scale the intensity of AMS1.

For a list of AMS sources, see “Alternate Modulation Source (AMS) List” on page 903.

Intensity [-99...+99]

This controls the depth and direction of the Intensity Mod AMS. Even if the main AMS1 Intensity is set to 0, Intensity Mod AMS can still control the final amount of AMS A over the full +/-99 range.

For example, if **AMS1** is set to the **Pitch EG**, and **Intensity Mod AMS** is set to **JS+Y**, positive settings mean that pushing the joystick away from yourself will increase the intensity of the Pitch EG modulation of LFO Frequency.

AMS2 [List of AMS Sources]

This selects the second modulation source for the LFO frequency. For a list of AMS sources, see “Alternate Modulation Source (AMS) List” on page 903.

Intensity [-99...+99]

This controls the amount of modulation from AMS2.

8-2c: Frequency MIDI/Tempo Sync

MIDI/Tempo Sync [Off, On]

On (checked): The LFO will synchronize to the system tempo, as set by either the Tempo knob or MIDI Clock. The LFO speed will be controlled by the **Base Note** and **Multiply** parameters, below. All settings for **Frequency** and **Frequency Modulation** will be ignored.

Off (unchecked): The Frequency settings will determine the speed of the LFO, and the tempo settings will have no effect.

Base Note [Musical Notation]

This sets the basic speed of the LFO, relative to the system tempo. The values range from a 32nd note to a whole note, including triplets.

Times (Sync. Times) [01...32]

This multiplies the length of the Base Note. For instance, if the Base Note is set to a sixteenth note, and Times is set to 3, the LFO will cycle over a dotted eighth note.

✓ **8-2: Page Menu Commands**

- Compare →p.112
- Write Program →p.112
- Exclusive Solo →p.113
- Copy LFO →p.182
- Swap LFO →p.182
- PAGE →p.126
- MODE →p.126

8-3: LFO 2 AMSource

8-4: LFO 3 AMSource

8-5: LFO 4 AMSource

The settings for LFOs 2-4 are identical to those for LFO1. For more information, see “8-2: LFO 1” on page 175.

PROGRAM > AL-1: AMS Mixer

The AMS Mixers combine two AMS sources into one, or process an AMS source to make it into something new.

For instance, they can add two AMS sources together, or use one AMS source to scale the amount of another. You can also use them to modify the response of realtime controllers.

The AMS Mixer outputs appear in the list of AMS sources, just like other controllers.

This also means that the original, unmodified inputs to the AMS Mixers are still available as well. For instance, if you use Aftertouch as an input to a AMS Mixer, you can use the processed version of the Aftertouch to control one AMS destination, and the original version to control another.

Finally, you can cascade the two AMS Mixers together, by using AMS Mixer 1 as an input to AMS Mixer 2.

9-1: AMS Mixer

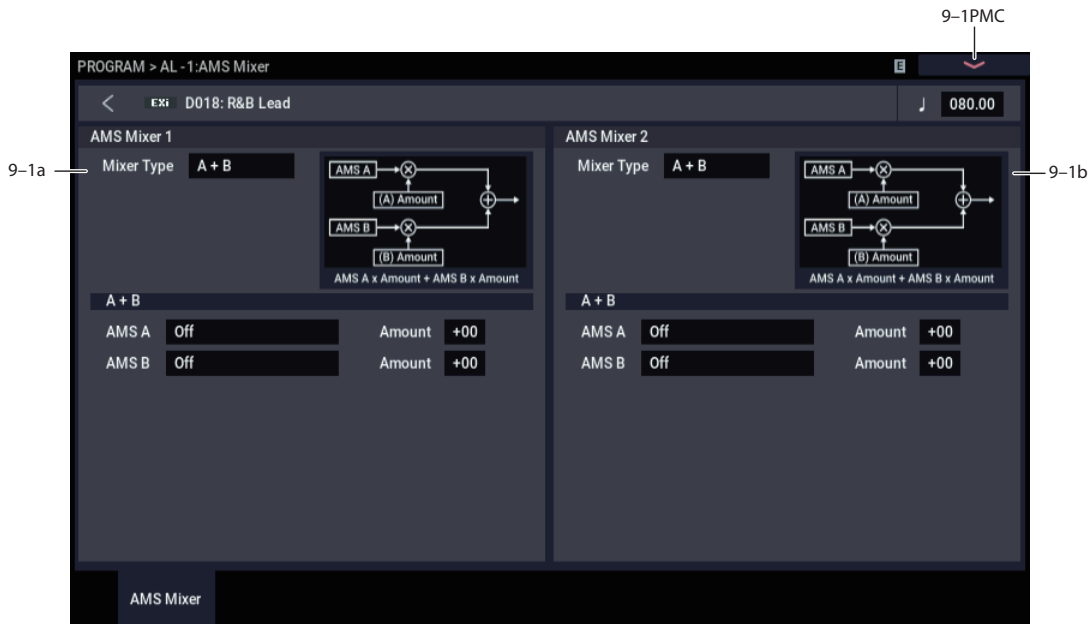

9-1a: AMS Mixer 1 AMSource

Mixer Type [A+B, Amt Ax B, Offset, Smoothing, Shape, Quantize, Gate]

This controls the type of processing performed by AMS Mixer 1. Each of the Mixer Types is discussed in detail elsewhere in the manual.

A+B adds two AMS sources together. For more information, see “A+B” on page 90.

Amt Ax B scales the amount of one AMS source with the other. See “Amt A x B” on page 90 for more details.

Offset adds or subtracts a constant value to or from an AMS source. For more information, see “Offset” on page 91.

Smoothing creates more gentle transitions between values, smoothing out abrupt changes such as a quick move on a joystick or a sharp edge on an LFO. For details, see “Smoothing” on page 92.

Shape adds curvature to the AMS input. For an in-depth description, see “Shape” on page 92.

Quantize turns smooth transitions into discrete steps. See “Quantize” on page 93 for more information.

Gate chooses between two AMS inputs (or fixed values) based on a third AMS source. See “Gate” on page 93 for more information.

9-1b: AMS Mixer 2 AMSource

This is the second AMS Mixer. Its parameters are exactly the same as those of AMS Mixer 1, above.

✓ 9-1: Page Menu Commands

- Compare →p.112
- Write Program →p.112
- Exclusive Solo →p.113
- PAGE →p.126
- MODE →p.126

AL-1: Tone Adjust

AL-1 Tone Adjust Default Settings

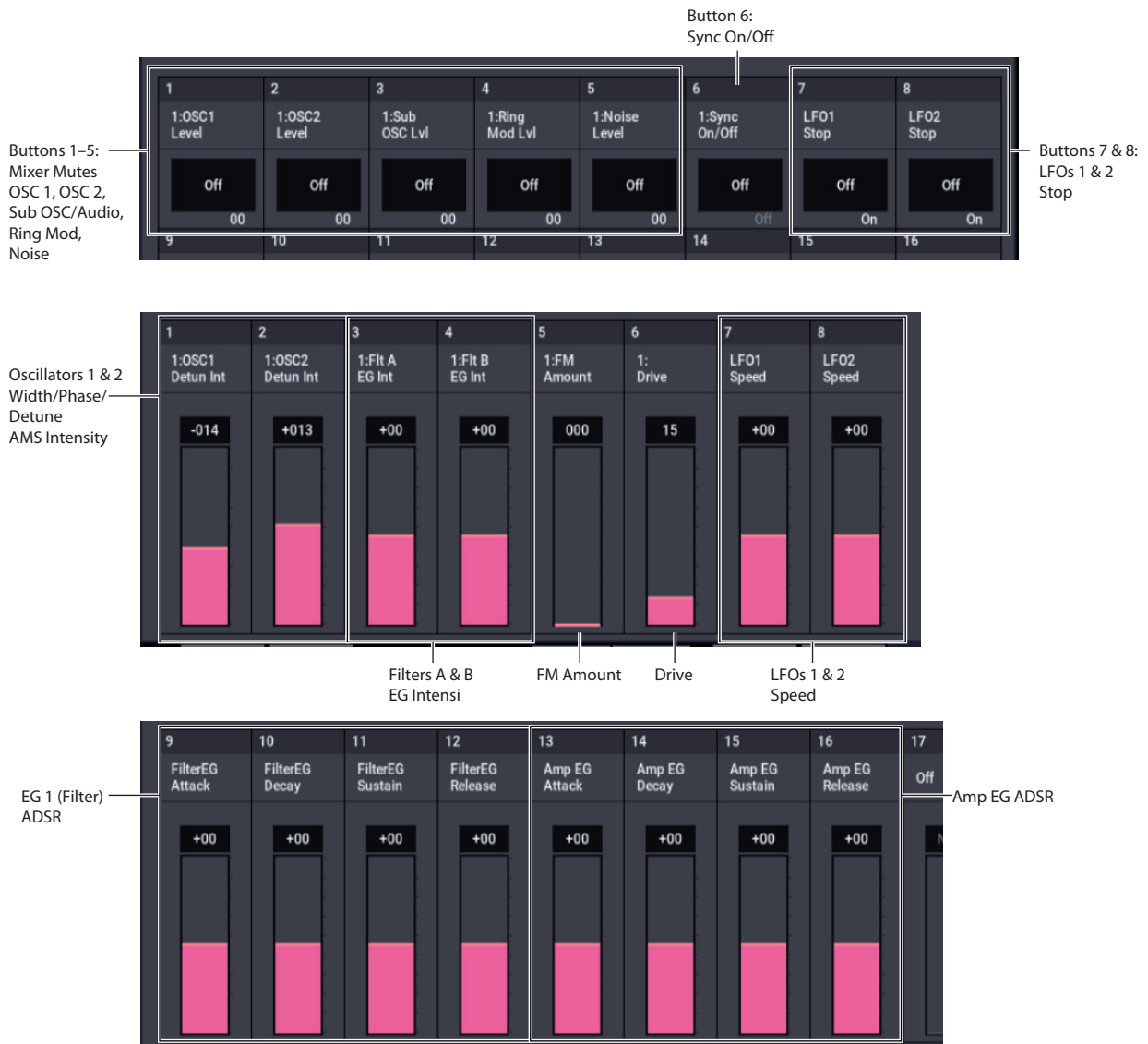

Tone Adjust provides an elegant physical interface to the AL-1’s parameters. Most of the factory sounds use the default layout, as shown above. You can also customize the layout for individual sounds, if desired.

For more information about Tone Adjust, please see “0–9a: Tone Adjust,” on page 29.

AL-1 Tone Adjust parameters

The AL-1 supports all of the Common Tone Adjust parameters, as described under “0–9a: Tone Adjust,” on page 29. It also adds a number of its own additional parameters, which apply only to the AL-1.

Note that these additional parameters are separate for each EXi, as opposed to being shared by both EXi in the Program.

All of the additional parameters are listed below. Each is marked as either relative (meaning that it scales the existing parameter value) or absolute (which over-writes the existing value).

Oscillator 1

- Tune (absolute)
- Waveform (absolute)
- Morph (absolute)
- Morph AMS Intensity (absolute)
- Detune/Pulse Width (absolute)
- Detune/Pulse Width AMS Intensity (absolute)

Oscillator 2

Oscillator 2 has the same Tone Adjust parameters as Oscillator 1, above.

Oscillators common

- Sync On/Off (absolute)
- FM Amount (absolute)
- FM AMS Intensity (absolute)

Mixer

- OSC 1 level (absolute)
- OSC 2 level (absolute)
- Sub OSC/Audio Input level (absolute)
- Ring Mod level (absolute)
- Noise level (absolute)

Filter A

In addition to the standard Tone Adjust filter parameters, the AL-1 adds the following:

- Type (absolute)
- Cutoff (absolute)
- Resonance (absolute)
- Frequency EG Intensity (absolute)
- Frequency LFO Intensity (absolute)

Filter B

Filter B has the same Tone Adjust parameters as Filter A, above.

Amp

- AMS 1 Intensity (absolute)
- AMS 2 Intensity (absolute)
- Drive (absolute)
- Low Boost (absolute)

EGs

In addition to supporting the standard Tone Adjust EG parameters, the AL-1 adds the following separate controls for both EG3 and EG4:

- Attack time (relative)
- Decay & Slope time (relative)
- Sustain level (relative)
- Release time (relative)

LFOs

In addition to supporting the standard Tone Adjust LFO parameters, the AL-1 adds the following separate controls:

- LFO 3 Speed (relative)
- LFO 3 Fade (relative)
- LFO 3 Delay (relative)
- LFO 3 Stop (absolute)
- LFO 4 Speed (relative)
- LFO 4 Fade (relative)
- LFO 4 Delay (relative)
- LFO 4 Stop (absolute)
- LFO 1, 2, 3, and 4 Waveform (absolute)
- LFO 1, 2, 3, and 4 Shape (absolute)

Step Sequencer

In addition to supporting the standard Tone Adjust Common Step Sequencer parameters, the AL-1 adds the following separate control for the per-voice Step Sequencer:

- Smoothing (relative)

Pitch

- Pitch Slope (absolute)
- Pitch LFO AMS Intensity (absolute)

EXi AL-1: Page Menu Commands

| | |
|---------------------|--------|
| Compare | →p.112 |
| Write Program | →p.112 |
| Exclusive Solo | →p.113 |
| Copy Envelope | →p.182 |
| Swap Envelope | →p.182 |
| Copy Step Sequencer | →p.140 |
| Copy LFO | →p.182 |
| Swap LFO | →p.182 |
| PAGE | →p.126 |
| MODE | →p.126 |

Copy Envelope

This copies settings from one AL-1 envelope to another.

1. Select “Copy Envelope” to open the dialog box.

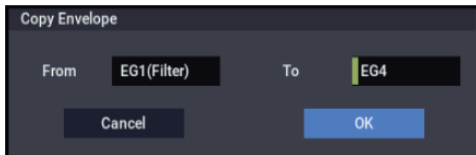

2. Use the “From” field to select the copy-source envelope.
3. Use the “To” field to select the copy-destination envelope.
4. Press the OK button to execute the Copy Envelope operation. If you decide not to execute, press the Cancel button.

Swap Envelope

This exchanges settings between two AL-1 envelopes.

1. Select “Swap Envelope” to open the dialog box.

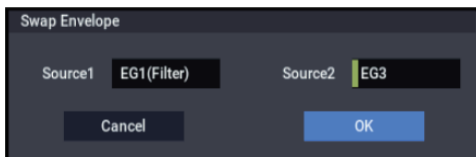

2. Use the “Source 1” and “Source 2” fields to select the two envelopes you want to swap.
3. Press the OK button to execute the Swap Envelope operation. If you decide not to execute, press the Cancel button.

Copy LFO

This copies settings from one AL-1 LFO to another.

1. Select “Copy LFO” to open the dialog box.

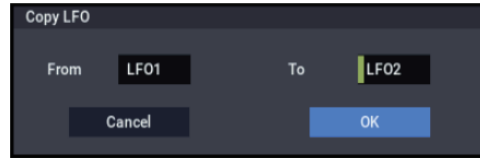

2. Use the “From” field to select the copy-source LFO.
3. Use the “To” field to select the copy-destination LFO.
4. Press the OK button to execute the Copy LFO operation. If you decide not to execute, press the Cancel button.

Swap LFO

This exchanges settings between two AL-1 LFOs.

1. Select “Swap LFO” to open the dialog box.

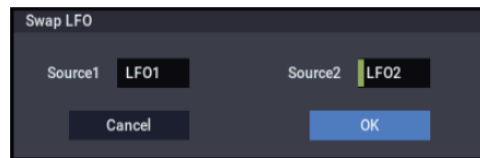

2. Use the “Source 1” and “Source 2” fields to select the two LFOs you want to swap.
3. Press the OK button to execute the Swap LFO operation. If you decide not to execute, press the Cancel button.

EXi: CX-3 Tonewheel Organ

CX-3 Overview

The CX-3 is a detailed model of a classic tone-wheel organ, based on Korg's ground-breaking CX-3 keyboard.

Its awesome sound starts with perfect tone-wheel phase coherency, resulting in pure, powerful sounding chords, just like the real thing. Subtleties such as different tone wheel types, adjustable overtones, leakage, and noise, along with detailed key-click modeling, provide unparalleled realism.

Amp modeling, Vibrato/Chorus, and Rotary Speaker effects are included in the model, so that you don't need to use any Insert Effects to re-create most classic organ sounds.

In EX mode, you can introduce additional drawbar and percussion harmonics, letting you produce new timbres unavailable on traditional organs.

If you're familiar with the CX-3 keyboard, you might want to check out "Changes from the original CX-3" on page 205 for an overview of some of the improvements in the NAUTILUS CX-3.

CX-3 uses EXi fixed resources

The CX-3 uses EXi fixed resources for the built-in rotary speaker, amp, vibrato chorus, and so on. These use up a small amount of processing power, even if you're not playing any notes.

Because of this, you can use a maximum of eight CX-3s simultaneously in a Combination or Song. If other EXis with fixed resources are in use, the maximum number of CX-3s will be reduced accordingly. Each EXi in each Program counts towards the maximum; for instance, a Program with two CX-3s counts as two, not as one.

On the other hand, once a CX-3 is running, each additional note you play takes up only a small amount of additional power—allowing up to 200 notes of polyphony.

For more information, see "CX-3 & other EXi: Limitations on EXi fixed resources" on page 380.

Unsupported EXi Common parameters

The CX-3 supports most of the EXi Common parameters except for scales and a number of the voice allocation options, as detailed below:

- **Single Trigger** (CX-3 always acts as if this was On)
- **Poly Legato**
- **Mono Legato** (simple Mono retrigger mode is supported, however)
- **Mono Mode** (Normal or Use Legato Offset)
- **Unison**, including **Number of Voices**, **Detune**, and **Thickness**
- **Scale**, including **Type**, **Key**, and **Random**

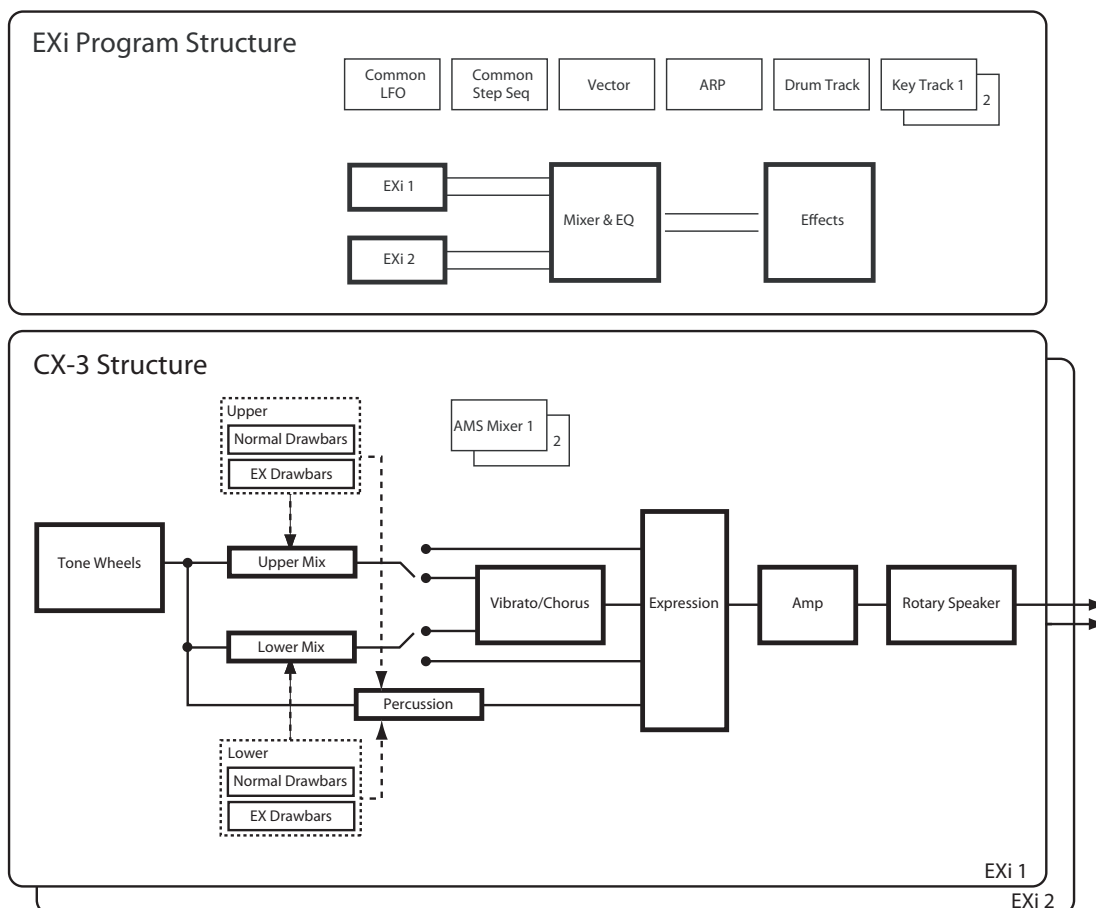

EXi PROGRAM > CX-3: Play

0-1: Overview

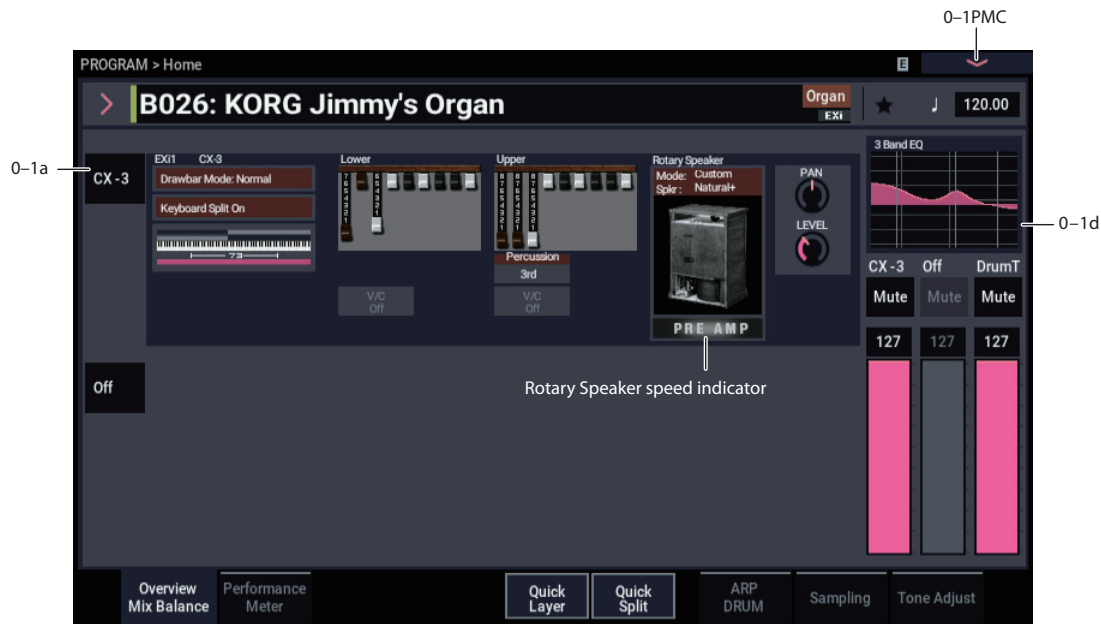

This is the main page of PROGRAM mode. For a full description of this page and all of its functions, please see “EXi PROGRAM > Home” on page 127. This section describes only the overview display, which differs for each individual EXi.

Rotary Speaker speed indicator

In PROGRAM mode, the Home page's CX-3 graphics show the current state of the Rotary Speaker (Fast, Slow, Stop, Preamp, or Off). Note that this is the current state—in other words, what you actually hear—which is a combination of the **Speed SW**, **Mode SW**, **Rotary On**, and **Amp Type** parameter settings and all associated AMS modulation.

Also: in PROGRAM, COMBINATION, SEQUENCER, and SET LIST modes, if there is an active Rotary Speaker, its current state (Fast, Slow, or Stop) is shown at the top of the display. This includes both CX-3 Programs and any Rotary Speaker effects. If there are two or more active Rotary Speakers, the state of the fastest one is shown. For instance, if a Combination has three CX-3 Programs, whose current states are Fast, Slow, and Stop respectively, the indicator will show Fast.

0-1b: Overview and Page Jump

This part of the page shows an overview of the most important settings for the Program's two EXi instruments. The specific parameters will vary, depending on which EXi are being used. The specific parameters for the AL-1 are described below.

The graphics give you a quick way to check all of these settings at a glance. They also let you jump instantly to any of the displayed parameters. Just touch one of the graphics, and you'll jump to the page containing its parameters. For instance, if you touch the Filter EG graphic, you'll go to the Filter EG page.

Tip: Pressing EXIT several times will always bring you back to this page.

Perc, V/C, and Split show programmed values—not AMS

For parameters other than the Rotary Speaker, the graphics show the programmed values, including any edits made via Tone Adjust. They do not update to show temporary changes made by AMS modulation.

For instance, pressing SW1 or SW2 will often turn Percussion on or off via AMS. You'll hear the sound change - but since the programmed value is still the same, the display won't be updated.

CX-3

Drawbar Mode

This shows whether the Drawbars are set to Normal or EX modes.

Press this area to jump to the PROGRAM > CX-3: Basic-Basic page.

Keyboard Split

This shows whether the Keyboard Split is turned on, or turned off.

Press this area to jump to the PROGRAM > CX-3: Split/Drawbar-Keyboard Split page.

Keyboard Split Zone/Common Key Zone

The upper portion of this graphic shows the keyboard split range within the CX-3.

Press this area to jump to the PROGRAM > CX-3: Split/Drawbar-Keyboard Split, PROGRAM > Basic/X-Y/Controllers-Program Basic page.

The lower portion shows the key zones for EXi1 and EXi2, as set on the Common section's Program Basic page, in relation to the entire MIDI note range. The range of the 61-, 73-, or 88-note keyboard is also shown, as appropriate.

Press this area to jump to the Program Basic page.

EX Percussion

This area shows the EX Percussion settings. It will only appear if the **Drawbar Mode** is set to EX.

Press this area to jump to the PROGRAM > CX-3: Percussion– EX Percussion page.

Lower

These graphics will only be displayed if **Keyboard Split** is turned On.

Lower Drawbars

This shows the Lower drawbar settings.

Press this area to jump to the PROGRAM > CX-3: Split/Drawbar– Drawbars page.

Percussion

This displays when “Percussion Assign” is set to “Lower” and “Percussion” is set to “On”. The percussion pitch setting is also shown.

Press this area to jump to the PROGRAM > CX-3: Percussion– Percussion page.

V/C On/Off

This shows whether the Vibrato/Chorus is turned on or off for the Lower drawbars.

Press this area to jump to the PROGRAM > Amp/VC/Rotary Speaker– Amp/V/C page.

EX Drawbars

This area shows the Lower EX drawbar settings. It will only appear if the **Drawbar Mode** is set to EX.

Press this area to jump to the PROGRAM > CX-3: Split/Drawbar– EX Drawbars page.

Upper**Upper Drawbars**

This shows the Upper drawbar settings.

Press this area to jump to the PROGRAM > CX-3: Split/Drawbar– Drawbars page.

Percussion

This displays when “Percussion Assign” is set to “Upper” and “Percussion” is set to “On”. The percussion pitch setting is also shown.

Press this area to jump to the PROGRAM > CX-3: Percussion– Percussion page.

V/C On/Off

This shows whether the Vibrato/Chorus is turned on or off for the Upper drawbars.

Press this area to jump to the PROGRAM > Amp/VC/Rotary Speaker– Amp/V/C page.

EX Drawbars

This shows the Upper EX drawbar settings.

Press this area to jump to the PROGRAM > CX-3: Split/Drawbar– EX Drawbars page.

Rotary Speaker**Mode**

This shows the **Amp/VC/Rotary Mode** (Classic CX-3 or Custom). Press this area to jump to the PROGRAM > CX-3: Basic– Basic page.

Spkr

This shows the **Speaker Type** selected for the Speaker Simulator.

Press this area to jump to the PROGRAM > CX-3: Amp/VC/Rotary Speaker– Rotary Speaker page.

Speaker graphic

This graphic represents the **Amp/VC/Rotary Mode** (Classic CX-3 or Custom). If the speaker is disabled—for instance, if **Rotary On** is not enabled, or if the **Amp Type** is set to Pre Amp—the graphic is grayed out.

Press this area to jump to the PROGRAM > CX-3: Basic– Basic page.

Rotary Speaker speed indicator

This shows the Rotary Speaker speed indicator (see “Rotary Speaker speed indicator” on page 184).

Press this area to jump to the PROGRAM > CX-3: Amp/VC/Rotary Speaker– Rotary Speaker page.

Amp/Vibrato/Chorus**Pan, Level**

Displays the “Pan” and “Output Level” values.

Press this area to jump to the PROGRAM > CX-3: Amp/VC/Rotary Speaker– Amp/Vibrato/Chorus page.

0–1d: Common**3Band EQ Graphic**

Mute (1) [On, Off]

Mute (2) [On, Off]

Mute (DrumT) [On, Off]

EXi1 Instrument Volume [000...127]

EXi2 Instrument Volume [000...127]

Drum Track Volume [000...127]

This is the same as with HD-1 programs. For more details, please see “0–1d: Common” on page 4.

✓ 0–1: Page Menu Commands

- Compare →p.112
- Write Program →p.112
- Exclusive Solo →p.113
- Show MS/WS/DKit Graphics →p.113
- Add To Set List →p.113
- Initialize Program →p.113
- PAGE →p.126
- MODE →p.126

PROGRAM > CX-3: Basic

4-1: Basic

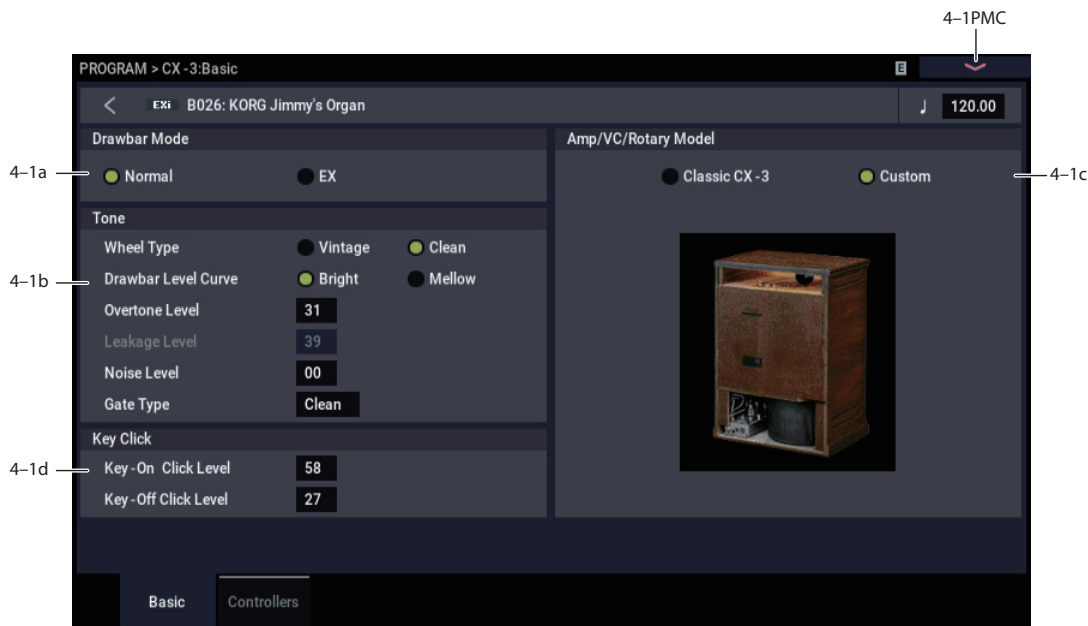

4-1a: Drawbar Mode

Drawbar Mode [Normal, EX]

This is a basic control, which affects the parameters available in the Drawbars and Percussion sections.

Normal mode models a standard tone-wheel organ, with 9 drawbars and single-pitch percussion.

EX mode adds four additional drawbars, with pitches adjustable in half-step increments between 16' and two octaves above 1'. It also allows you to create the percussion using up to five different pitches, each with adjustable volume levels.

4-1b: Tone

Wheel Type [Vintage, Clean]

Vintage offers an organic, complex tone. It includes some amount of additional harmonics for each note, which can be further increased by using the **Overtone Level** parameter, below. It also adds “leakage,” a pitched noise caused by the mix of all 91 tone wheels “leaking” into each individual note—a characteristic part of the authentic tone-wheel organ sound. The **Leakage Level** parameter, below, controls the volume of this component.

Clean gives you a pristine, perfect set of tone wheels, with no leakage noise. By default, these tone wheels have no additional overtones—but you can add them by using the **Overtone Level** parameter, below.

Drawbar Level Curve [Bright, Mellow]

This controls the way in which the tone-wheel levels change in relation to pitch, which contributes to the overall brightness of the sound.

Bright produces a crisp effect, slightly brighter than traditional tone-wheel organs.

Mellow produces a slightly darker, more traditional tone.

Overtone Level [0...99]

This controls the timbre of the individual tone wheels. Increasing the **Overtone Level** adds more harmonics, for a brighter, richer tone.

The **Wheel Type** setting, above, determines both the specific harmonics added and their volume levels.

Leakage Level [0...99]

This specifies the amount of drawbar leakage, both into played notes and into the constant noise (see **Noise Level**, below).

This parameter is available only when the **Wheel Type**, above, is set to **Vintage**. When the **Wheel Type** is set to **Clean**, it is grayed out.

Noise Level [0...99]

This lets you add a constant amount of noise to the outputs - just like you might find in older vintage gear. The noise will be present whether or not any notes are being played.

The noise includes both colored broad-band noise and tone wheel leakage. The amount of leakage within the noise is scaled by **Leakage Level**, described above.

Gate Type [Clean, Dirty]

This affects the sound character when notes are turned on or off. It is similar in concept to **Key Click**, below, but has a different timbral character.

Clean does not add any additional gate noise.

Dirty adds a small amount of noise at note-on and note-off, for a small amount of extra punch. You can also use this if you're looking to duplicate the gate timbre of the CX-3 and BX-3.

4-1c: Amp/VC/Rotary mode

Amp/VC/Rotary mode [Classic CX-3, Custom]

This parameter, new in NAUTILUS system version 2.1, switches between old and new versions of the amplifier, vibrato/chorus, and rotary speaker effects.

Classic CX-3: This is a rotary speaker model used on the original versions of the OASYS and KRONOS.

Custom: This is a more refined rotary speaker model. The following improvements were made.

- **Custom's** amp section uses a new tube model. When driven into distortion through high **Gain** or **Expression**, **Custom's** tone is warmer and smoother, with more mid-range frequencies; **Classic CX-3's** is more fuzzy and hard-clipped. Each has its place for different applications.
- **Custom** provides a selection of different **Speaker Types**, which can have a significant effect on the overall tone. For more information, see "Speaker Type" on page 201.
- The **Horn Mic Distance** is revised, allowing you to get closer to the speaker without affecting brightness.
- Various other changes have been made to improve the rotary speaker's stereo sensation, timbre, and authenticity.
- The Vibrato Chorus has been updated as well, and is now better-sounding and more true to the original hardware.

Changing a Program from Classic CX-3 to Custom

The responses of the **Expression** and **Amp Gain** controls are different between the two modes. In **Custom**, greater amounts of distortion only kick in at the top of the ranges. Because of this, you'll usually want to turn up the **Amp Gain** when converting a sound from **Classic CX-3** to **Custom**, and adjust the **Expression** and **Output Level** as necessary. To do so:

1. Use **Amp Gain** to set the maximum distortion amount.
2. Configure **Expression** as a dynamic control—via a pedal, for instance.

Expression controls the input volume to the amp section, affecting both volume and tone.

3. Finally, use the **Output Level** to adjust the overall volume as necessary.

Output Level controls the post-amp level, and so it affects only volume.

For more information, see "Expression Level" on page 188, "Amp Gain" on page 197, and "Output Level" on page 198.

4-1d: Key Click

Pressing down or releasing a key on a tone wheel organ can result in arcing between the contacts, producing a characteristic "Key Click" sound. This section models that effect.

Key-On Click Level [0...99]

This controls the amount of click noise at note-on.

Key-Off Click Level [0...99]

This controls the level of the click noise at note-off.

✓ 4-1: Page Menu Commands

- Compare →p.112
- Write Program →p.112
- Exclusive Solo →p.113
- PAGE →p.126
- MODE →p.126

4–2: Controllers

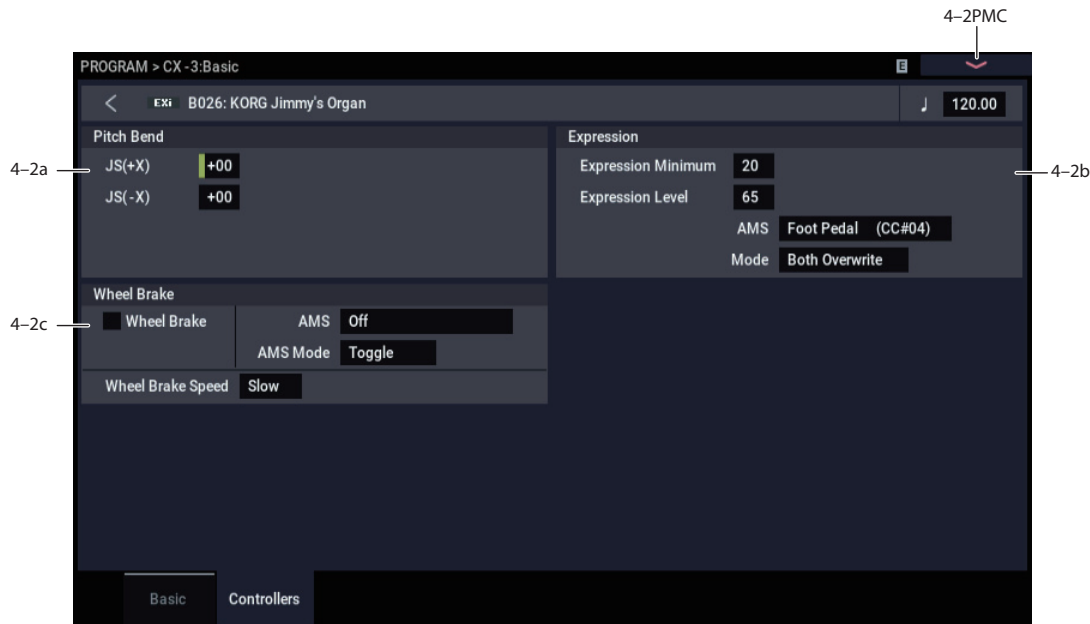

4–2a: Pitch Bend

JS+ X [-60...+12]

This sets the maximum amount of pitch bend, in semitones, when you move the joystick to the right. For normal pitch bend, set this to a positive value.

For example, if you set this to +12 and move the joystick all the way to the right, the pitch will rise one octave above the original pitch.

JS- X [-60...+12]

This sets the maximum amount of pitch bend, in semitones, when you move the joystick to the left. For normal pitch bend, set this to a negative value.

For example, if you set this to –60 and move the joystick all the way to the left, the pitch will fall five octaves below the original pitch.

4–2b: Expression

Expression adjusts both the volume level and the amount of distortion. At lower Expression values, both the low bass and high treble frequencies are slightly emphasized. The Amp section interacts with Expression; for more details, see “7–1a: Amp,” on page 197.

To allow optimal modulation flexibility, the AMS works differently from most other parameters. See **Mode**, below, for more details.

Expression Minimum [0...30]

This specifies the minimum level when the Expression Level parameter or Expression AMS are at 0.

Expression Level [0...99]

This sets the default Expression level. It will be grayed out if the **Mode**, below, is set to **AMS Only**.

AMS [List of AMS Sources]

This selects an AMS source to modulate Expression. For a list of AMS sources, see “Alternate Modulation Source (AMS) List” on page 903.

This parameter is grayed out if **Mode**, below, is set to **Level Only**.

NOTE: The MIDI Expression controller (CC #11) is hard-wired to scale the channel volume level. So, despite the similar name, it’s best to use another controller as an AMS source.

Mode [Level Only, AMS Only, Both Scale, Both Overwrite]

This controls how the AMS interacts with the programmed **Expression Level**.

Level Only: The **Expression Level** parameter has complete control over Expression. The **AMS** parameter is grayed out and has no affect.

AMS Only: The **AMS** input has complete control over Expression, while the **Expression Level** parameter is grayed out and has no affect.

Both Scale: The values of **Expression Level** and **AMS** are multiplied to produce the Expression level. For the math-friendly, a value of 99 is treated as 1.0.

Both Overwrite: **Expression Level** and **AMS** both write directly to the Expression level. If the **Expression Level** parameter is updated, it directly controls Expression, and the last value from **AMS** is ignored. If the **AMS** input moves, it also directly controls Expression, and the setting of the **Expression Level** parameter is ignored.

Normally, after a Program is selected, the **Expression Level** will be used until the **AMS** input moves. However, there is one exception to this. If the selected **AMS** source is the same as the one assigned to the Foot Pedal in GLOBAL > Controllers/Scales– Controllers (see “Foot Pedal Assign” on page 675), and the Global **Foot Pedal Behavior** parameter

is set to Keep Current, then the Program will initially use the AMS input, until (and unless) the **Expression Level** setting is changed. This prevents abrupt jumps in level when using the expression pedal and switching between Programs.

Disconnected pedals

If the Foot Pedal is assigned to an AMS source but a pedal is not physically connected to the NAUTILUS, the result is the same as if the pedal was pressed down all the way: the AMS signal will be at its maximum value.

If you regularly use a pedal to control **Expression**, but then for some reason need to play without the pedal, simply go to GLOBAL > Controllers/Scales- Controllers and set **Foot Pedal Assign** to **None**. You can then use Tone Adjust Slider 3 in Tone Adjust to control **Expression** as desired (assuming that the sound uses the default Tone Adjust configuration).

4-2c: Wheel Brake

Tone wheel organs actually have physical wheels, which gradually come up to speed when you turn the power on, and gradually slow to a stop when you turn the power off. As the wheels rotate more quickly, the pitch rises; as they slow down, the pitch falls.

This section models this behavior, for use as a special effect.

Wheel Brake [Off, On]

This parameter allows you to manually control the Wheel Brake. Off is the default; the tone wheels will turn normally. Changing this to On will make the tone wheels gradually slow down, and eventually stop altogether.

AMS [List of AMS sources]

This selects an AMS source to control the Wheel Brake.

For a list of AMS sources, see “Alternate Modulation Source (AMS) List” on page 903.

AMS Mode [Toggle, Momentary]

This parameter controls the way in which the Wheel Brake AMS works.

When this is set to **Toggle**, the Wheel Brake AMS will alternate between “power on” and “power off.” For instance, if **Wheel Brake** is set to **Off**, and **AMS** is assigned to a footswitch, the first press will cause the wheel rotation to slow, and the next press will bring them back up to speed again.

Momentary means that the power is turned “off” only while the controller is enabled. Continuing the example from above, when the footswitch is pressed down, the wheel rotation will slow down; when the footswitch is released, the wheel rotation will speed up again.

AMS lets you switch to the opposite of the programmed setting. For instance, if **Wheel Brake** is set to **On** (unlikely but possible!), and the **AMS Mode** is set to **Momentary**, then pressing down on the footswitch would cause the tone wheels to come up to speed.

If you set AMS to use a continuous controller, such as the Joystick, values of 0–63 are as if the switch was off, and values of 64–127 are as if the switch was on.

Finally - note that the assignable switches, **SW1** and **SW2**, can themselves be set to either momentary or toggle modes, and these settings are reflected by the switch LEDs. Individual parameter mode settings, such as the Wheel Brake AMS Mode, do *not* affect the LEDs.

So, if you’re using SW1 or SW2 as the AMS source, it’s best to set the AMS Mode to Momentary, and then just let the switch itself determine the momentary/toggle behavior.

Wheel Brake Speed [Slow, Fast]

This controls the speed at which the wheels will slow down and speed up.

✓ 4-2: Page Menu Commands

- Compare →p.112
- Write Program →p.112
- Exclusive Solo →p.113
- PAGE →p.126
- MODE →p.126

PROGRAM > CX-3: Split & Drawbars

You can set up the organ to use a single sound across the entire keyboard, or to split the keyboard between two different sets of drawbars.

5-1: Keyboard Split

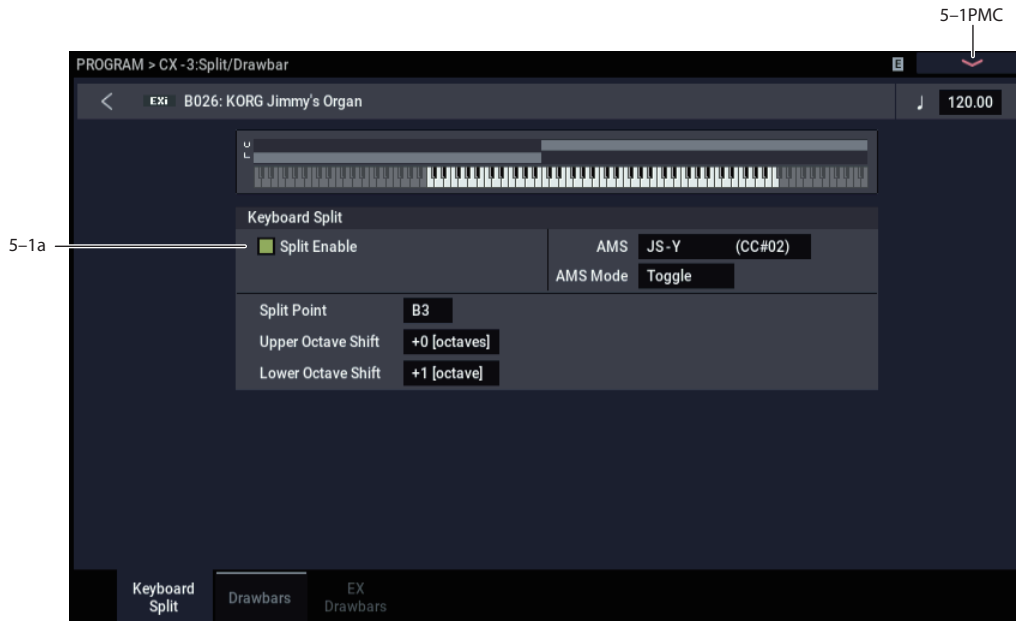

5-1a: Split

Split Enable [Off, On]

This turns the split on and off.

When Split is Off, only the Upper drawbars will be used.

AMS [List of AMS Sources]

This allows you to assign an AMS source to toggle the split on and off.

For a list of AMS sources, see “Alternate Modulation Source (AMS) List” on page 903.

AMS Mode: [Momentary, Toggle]

This determines the behavior of Split Enable AMS. For details, see “AMS Mode” on page 189.

Split Point [C-1...G9]

This sets the highest key of the lower split range.

Upper Octave Shift [-2 octaves...+2 octaves]

This raises or lowers the pitch of the Upper drawbars in one-octave steps.

Lower Octave Shift [-2 octaves...+2 octaves]

This raises or lowers the pitch of the Lower drawbars in one-octave steps.

5-1: Page Menu Commands

- Compare →p.112
- Write Program →p.112
- Exclusive Solo →p.113
- PAGE →p.126
- MODE →p.126

5-2: Drawbars

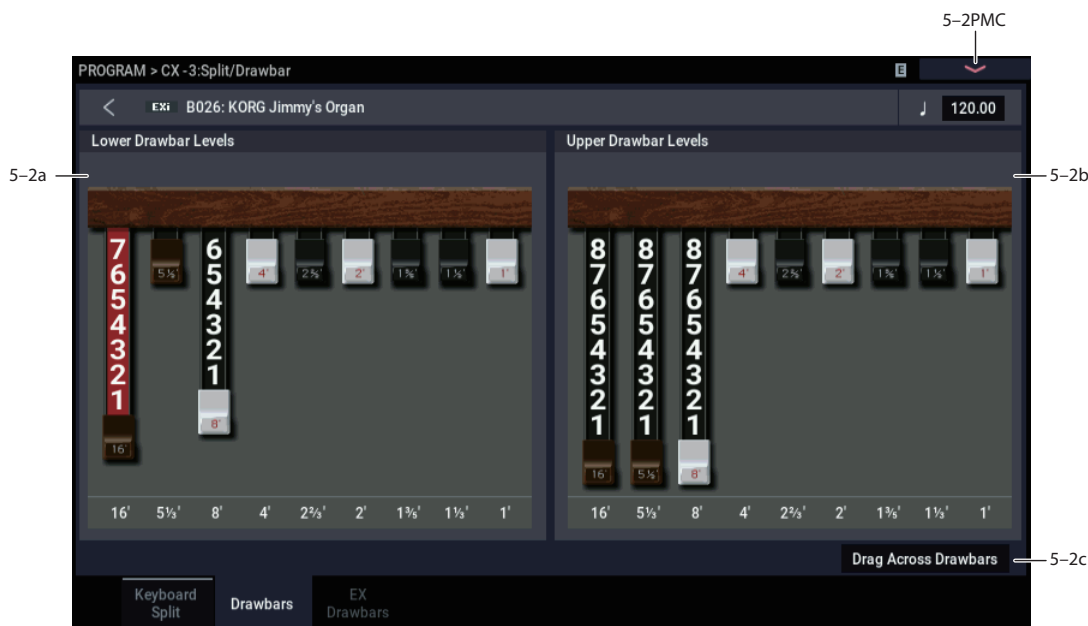

The drawbars are the heart of the CX-3. These settings control the basic harmonic content of the sound, the perceived fundamental pitch, and the basic volume level.

Use Tone Adjust for physical drawbars

Using Tone Adjust, you can map the drawbars to the nine sliders.

Like traditional tone wheel organs, the throw of the sliders is reversed from that of a mixer: all the way up is 0, and all the way down is the maximum (8).

Wrap-around

As with traditional organs, the tone wheels produce pitches between C2 and F#8. Depending on the notes that you play, certain drawbar settings may imply pitches outside of this range. In this case, the drawbar pitches will be “wrapped around” by one or more octaves to fit within the available range.

For instance, the 1’ drawbar would normally sound 3 octaves above the note that you play. If you play a D6 on the keyboard, this would imply that the 1’ play a D9. Since the tone wheels can’t play a D9, however, the 1’ drawbar is “wrapped around” to the highest possible D - a D8.

The same thing will happen on the low end. For instance, the 16’ drawbar normally sounds one octave below the played note. If you play an F1 on the keyboard, this would imply that the 16’ sound at F0. Since this is far below the range of the tone wheels, the 16’ sounds at its lowest possible F - an F2.

Interaction between Percussion, 1’ drawbar, and EX mode

Percussion can be assigned to either the Upper or Lower split. When the **Drawbar Mode** is set to **Normal**, and percussion is turned on, the 1’ drawbar of the split assigned to percussion becomes silent. The other side of the split is not affected.

This models the behavior of the original instruments, in which the 1’ bus bar was diverted in order to trigger the percussion.

When the **Drawbar Mode** is set to **EX**, this restriction is removed; the 1’ drawbar continues to sound regardless of whether or not percussion is turned on.

5-2a: Lower Drawbar Levels

These parameters control the individual drawbar volume levels for the Lower split. The drawbars express their pitches in terms of feet, referring back to pipe organs, in which halving the length of a pipe will raise its pitch by one octave. So, 8’ is an octave higher than 16’, 4’ is an octave higher than 8’, and so on.

You can adjust these parameters by using the on-screen drawbar graphics, or use the physical faders via Tone Adjust, as described above.

Note that when **Split** is turned **Off**, only the Upper drawbars are used; the Lower drawbar settings will have no effect.

16’ **[0...8]**

This is the volume for the lowest drawbar.

0 means that the drawbar will be silent, and **8** is the maximum volume.

5-1/3’, 8’, 4’, 2-2/3’, 2’, 1-3/5’, 1-1/3’, 1’ **[0...8]**

These set the volume levels for the remaining 8 drawbars.

5-2b: Upper Drawbar Levels

These parameters specify the level for each drawbar used by the Upper split. Also, when **Split** is turned **Off**, the Upper drawbars are used for the entire keyboard.

The settings are just the same as for the Lower drawbars. For more details, please see “5-2a: Lower Drawbar Levels,” above.

5-2c: Drag Across Drawbars

Drag Across Drawbars [Off, On]

Off (un-checked): When **Drag Across Drawbars** is **Off**, you can edit CX-3 drawbars just as you would other slider controls, by touching and dragging the individual drawbars one by one. This is the default.

On (checked): When **Drag Across Drawbars** is **On**, you can edit multiple drawbars in a single gesture. Just drag a shape across the drawbars horizontally.

✓ 5-2: Page Menu Commands

- Compare →p.112
- Write Program →p.112
- Exclusive Solo →p.113
- Copy Drawbars →p.206
- Swap Drawbars →p.206
- PAGE →p.126
- MODE →p.126

5-3: EX Drawbars

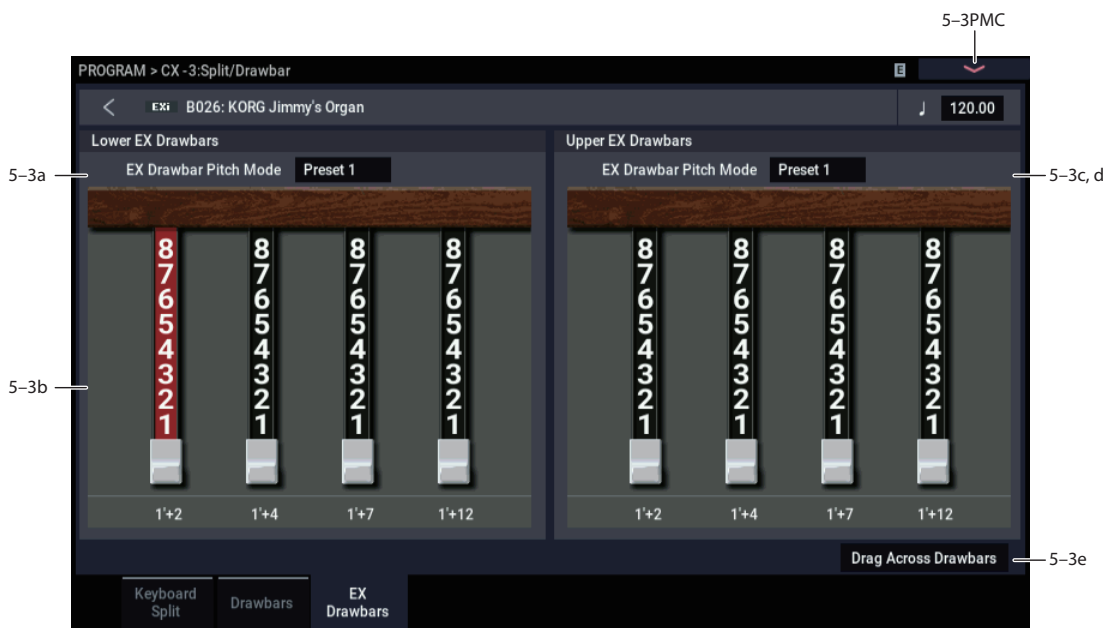

When the **Drawbar Mode** is set to **EX**, this adds four extra drawbars to the basic nine, with pitches adjustable in half-step increments between 16’ and two octaves above 1’. You can select from four preset combinations of drawbar pitches, or create your own from scratch.

When the **Drawbar Mode** is set to **Normal**, this section is grayed out.

Wrap-around and EX mode

Any harmonics above F#8 are “wrapped around” so that they will sound one or more octaves lower. Similarly, harmonics below C2 will be wrapped around to sound an octave higher. For more details, see “Wrap-around” on page 191.

In particular, this means that high settings of the EX Drawbar 1-4 Pitch parameters, below, may only be perceptible in the lower octaves of the keyboard.

5-3a: Lower EX Drawbars

These parameters control the individual EX drawbar pitches and volume levels for the Lower split.

EX Drawbar Pitch Mode [Preset 1...4, Custom]

Presets 1-4 are the CX-3’s default Pitch settings for the set of four EX Drawbars. When one of the Presets is selected, the EX Drawbar 1-4 Pitch parameters, below, are grayed out.

Custom lets you specify the pitches for each EX drawbar, using the EX Drawbar 1-4 Pitch parameters.

5-3b: Custom Drawbar Settings

Ex Drawbar 1 Pitch [16’...1’ +24]

This specifies the pitch assigned to EX Drawbar 1. The values are expressed in organ feet and semitones, with single-semitone steps from 16’ to 1’ +24 semitones.

This parameter is only available if the **EX Drawbar Mode** is set to **Custom**. Otherwise, it is grayed out.

Ex Drawbar 1 Level [0...8]

This is the volume for EX Drawbar 1.

0 means that the drawbar will be silent, and **8** is the maximum volume.

Ex Drawbars 2-4 Pitch [16'...1' +24]

These parameters specify the pitch assigned to EX Drawbars 2-4. For more information, see “Ex Drawbar 1 Pitch,” above.

Ex Drawbars 2-4 Level [0...8]

These parameters specify the volumes of EX Drawbars 2-4. For more information, see “Ex Drawbar 1 Level,” above.

5-3c and 5-3d: Upper EX Drawbars

These parameters control the individual EX drawbar pitches and volume levels for the Upper split. The controls are identical to those for the Lower EX Drawbars, as described above.

5-3e: Drag Across Drawbars**Drag Across Drawbars** [Off, On]

This controls how touch-drag edits the drawbars. For more information, see “Drag Across Drawbars” on page 192.

✓ 5-3: Page Menu Commands

- Compare →p.112
- Write Program →p.112
- Exclusive Solo →p.113
- Copy Drawbars →p.206
- Swap Drawbars →p.206

- PAGE →p.126
- MODE →p.126

PROGRAM > CX-3: Percussion

Percussion adds a pitched attack to the notes, for a more crisp, punchy timbre. When you play legato, percussion will only sound for the first note in the phrase.

6-1: Percussion

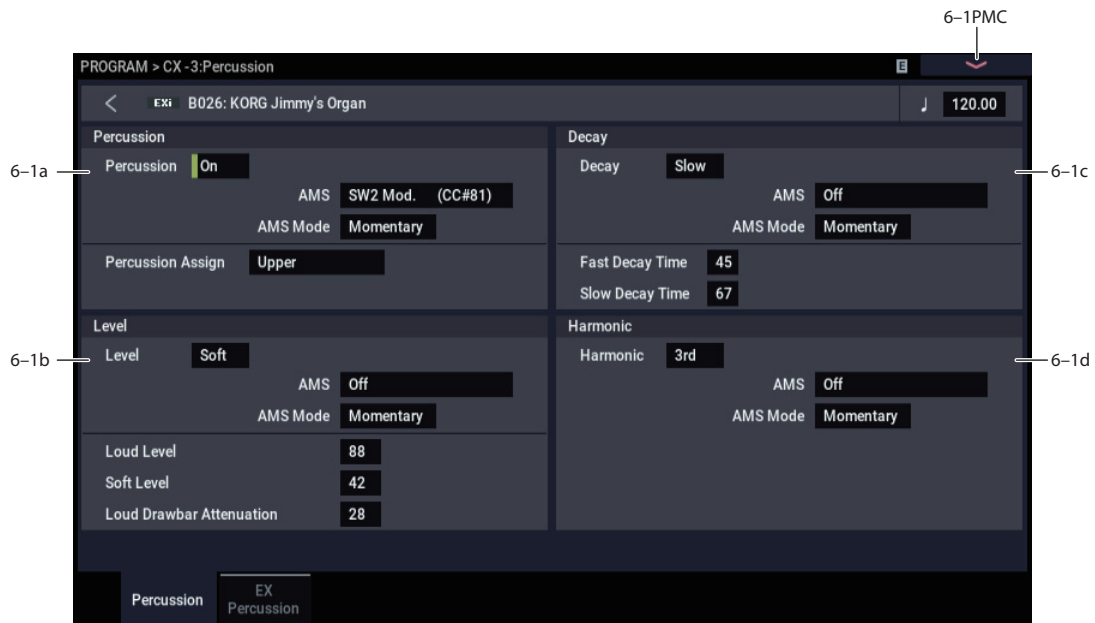

6-1a: Percussion

Percussion [Off, On]

This toggles the Percussion section on and off.

Note that enabling Percussion for a set of drawbars (Upper or Lower) may affect the set's 1' drawbar; for more information, see "Interaction between Percussion, 1' drawbar, and EX mode" on page 191.

AMS [List of AMS Sources]

This selects an AMS source to turn the Percussion on or off. For a list of AMS sources, see "Alternate Modulation Source (AMS) List" on page 903.

AMS Mode [Toggle, Momentary]

This determines the behavior of the Percussion AMS. For details, see "AMS Mode" on page 189.

Percussion Assign [Lower, Upper]

This assigns the percussion to either the lower or upper drawbars. The default is **Upper**. Setting it to **Lower**, instead, allows you to play a bass line with percussion.

If **Split** is **Off**, Percussion is automatically assigned to the Upper drawbars.

6-1b: Level

Level [Soft, Loud]

This toggles the Percussion Level between Soft and Loud. The actual volume levels are determined by the **Loud Level** and **Soft Level** parameters, below.

Note that the Percussion Level parameter can also affect the volume of the drawbars, as controlled by the **Loud Drawbar Attenuation** parameter.

AMS [List of AMS Sources]

This selects an AMS source to switch the Percussion Level between Soft and Loud. For a list of AMS sources, see "Alternate Modulation Source (AMS) List" on page 903.

AMS Mode [Toggle, Momentary]

This determines the behavior of the Level AMS. For details, see "AMS Mode" on page 189.

Loud Level [00...99]

This sets the volume of the percussion when Percussion Level is set to Loud.

Soft Level [00...99]

This sets the volume of the percussion when Percussion Level is set to Soft.

Loud Drawbar Attenuation [00...99]

On traditional tonewheel organs, setting the Level to Loud (or disabling the Soft button) reduces the overall drawbar volume.

To put it another way, setting the Level to Soft makes the drawbars louder.

This parameter controls the difference in drawbar volume between the Soft and Loud Percussion settings.

6-1c: Decay

Decay [Slow, Fast]

This toggles the Percussion Decay time between Slow and Fast. The actual decay times are determined by the **Fast Decay Time** and **Slow Decay Time** parameters, below.

AMS [List of AMS Sources]

This selects an AMS source to switch the Percussion Decay time between Slow and Fast. For a list of AMS sources, see “Alternate Modulation Source (AMS) List” on page 903.

AMS Mode [Toggle, Momentary]

This determines the behavior of the Decay AMS. For details, see “AMS Mode” on page 189.

Fast Decay Time [00...99]

This sets the decay time when the Decay parameter is set to Fast.

Slow Decay Time [00...99]

This sets the decay time when the Decay parameter is set to Slow.

6-1d: Harmonic

Harmonic [2nd, 3rd]

This selects the pitch of the percussion, in harmonics relative to the 8’ drawbar.

2nd produces the same pitch as the 4’ drawbar - one octave higher than the 8’.

3rd produces the same pitch as the 2 2/3’ drawbar - one octave and a fifth higher than the 8’.

AMS [List of AMS Sources]

This selects an AMS source to switch the Harmonic between 2nd and 3rd. For a list of AMS sources, see “Alternate Modulation Source (AMS) List” on page 903.

AMS Mode [Toggle, Momentary]

This determines the behavior of the Harmonic AMS. For details, see “AMS Mode” on page 189.

✓ 6-1: Page Menu Commands

- Compare →p.112
- Write Program →p.112
- Exclusive Solo →p.113
- PAGE →p.126
- MODE →p.126

6-2: EX Percussion

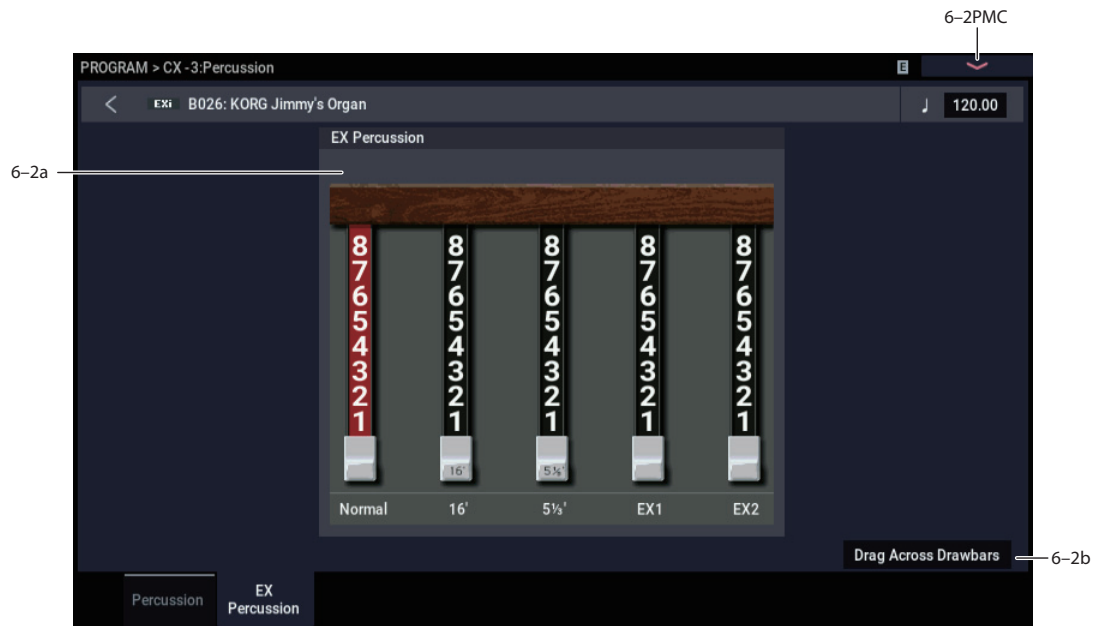

When the **Drawbar Mode** is set to **EX**, the Percussion can use a mix of up to five drawbar pitches, instead of just one.

These include 2-2/3' or 4' (depending on the setting of the Percussion Harmonic parameter), 16', 5-1/3', and the pitches of the first two EX drawbars. You can set the levels for each of the five drawbars independently.

This section is grayed out when **Drawbar Mode** is set to **Normal**.

6-2a: EX Percussion

Normal Percussion [0...8]

This sets the volume of the 2nd or 3rd harmonic (2-2/3' or 4' drawbars), depending on the setting of the **Percussion Harmonic** parameter.

16' [0...8]

This sets the volume of the 16' drawbar within the Percussion pulse.

5 1/3' [0...8]

This sets the volume of the 5-1/3' drawbar within the Percussion pulse.

EX Drawbar 1 [0...8]

This sets the volume of EX Drawbar 1 within the Percussion pulse.

EX Drawbar 2 [0...8]

This sets the volume of EX Drawbar 2 within the Percussion pulse.

6-2b: Drag Across Drawbars

Drag Across Drawbars [Off, On]

This controls how touch-drag edits the drawbars. For more information, see "Drag Across Drawbars" on page 192.

6-2: Page Menu Commands

- Compare →p.112
- Write Program →p.112
- Exclusive Solo →p.113
- PAGE →p.126
- MODE →p.126

PROGRAM > CX-3: Amp, V/C, Rotary Speaker

7-1: Amp/V/C



7-1a: Amp

Amp Type [Type 1, Type 2, Pre Amp]

This selects one of two amp models, or a direct line-out from the organ's preamp.

Type 1 is a standard powered amp for organ, producing a warm, fat tone.

Type 2 yields a less colored tone, with more high frequencies than Type 1.

PreAmp is the sound of a direct line-out from the organ.

Important: Since Pre Amp models a direct line-out, it disables the Rotary Speaker entirely. To use the Rotary speaker, set **Amp Type** to Type 1 or Type 2 instead.

Amp Gain [00...99]

This adjusts the gain when **Amp Type** is set to **Type 1** or **Type 2**. It does not apply if the **Amp Type** is set to **PreAmp**.

Expression also adjusts the drive into the Amp section. With higher **Amp Gain** settings, you'll get more overdrive and distortion as you increase the **Expression** amount. For more information, see "4-2b: Expression," on page 188.

AMS [List of AMS Sources]

This selects an AMS source to modulate the **Amp Gain**. For a list of AMS sources, see "Alternate Modulation Source (AMS) List" on page 903.

Intensity [-99...+99]

This controls the depth and direction of the AMS modulation of **Amp Gain**.

7-1b: EQ

Treble [-10...+10]

This adjusts the high frequency range of the amp, as selected by **Amp Type**.

Mid [-10...+10]

This adjusts the mid-frequency range of the amp, as selected by **Amp Type**.

Bass [-10...+10]

This adjusts the low frequency range of the amp, as selected by **Amp Type**.

7-1c: Vibrato/Chorus

Vibrato/Chorus is a traditional organ effect, similar to but not the same as other chorus effects. It adds varying degrees of LFO-driven flutter and richness to the timbre, and combines nicely with the rotary speaker.

In addition to the six traditional presets, the CX-3 allows you to create your own custom settings, which can then be modulated via AMS.

There is a single Vibrato/Chorus effect, and each set of drawbars can either be routed through the effect or go straight on to the rotary speaker and outputs.

Upper Drawbars V/C [Off, On]

This routes the upper drawbars through the Vibrato/Chorus.

AMS [List of AMS Sources]

This selects an AMS source to turn Vibrato/Chorus on or off for the Upper Drawbars.

AMS Mode [Toggle, Momentary]

This determines the behavior of the Vibrato/Chorus AMS for the Upper drawbars. For details, see “AMS Mode” on page 189.

Lower Drawbars V/C [Off, On]

This routes the lower drawbars through the Vibrato/Chorus.

AMS [List of AMS Sources]

This selects an AMS source to turn Vibrato/Chorus on or off for the Upper Drawbars. For a list of AMS sources, see “Alternate Modulation Source (AMS) List” on page 903.

AMS Mode [Toggle, Momentary]

This determines the behavior of the Vibrato/Chorus AMS for the Upper drawbars. For details, see “AMS Mode” on page 189.

Input Trim [000...100]

This controls the input level to the Vibrato/Chorus.

It applies only to the set(s) of drawbars routed through the Vibrato/Chorus, via the V/C On/Off buttons above. You can use this to compensate for volume level differences between the output of the Vibrato/Chorus and the dry signal, so that the volume stays constant when you switch the V/C on or off.

Note that the output volume of the V/C will vary, depending on the selected Preset or the settings of the Custom parameters.

Mode [Preset/Custom]

When **Mode** is set to **Preset**, the Vibrato/Chorus will use the settings under Preset, below. These are the classic V1-3 and C1-3 settings.

When **Mode** is set to **Custom**, the Vibrato/Chorus uses the settings under Custom, below. These allow you to create your own versions of the effect.

7-1d: Preset

These parameters are available only if the **Mode**, above, is set to **Preset**.

Type [V1, C1, V2, C2, V3, C3]

This selects one of the six classic Vibrato/Chorus presets. “V” stands for Vibrato, and “C” stands for Chorus.

AMS [List of AMS Sources]

This selects an AMS source to modulate the **Type**. For a list of AMS sources, see “Alternate Modulation Source (AMS) List” on page 903.

Intensity [-05...+05]

This controls the depth and direction of the AMS modulation for the **Type**.

7-1e: Custom

These parameters are available only if the **Mode**, above, is set to **Custom**.

Mix [0...100]

This adjusts the balance between the Vibrato and Chorus effects. **0** is all Vibrato; **100** is all Chorus.

AMS [List of AMS Sources]

This selects an AMS source to modulate the **Mix**. For a list of AMS sources, see “Alternate Modulation Source (AMS) List” on page 903.

Intensity [-100...+100]

This controls the depth and direction of the AMS modulation for **Mix**.

Depth [0...100]

This sets the depth of Vibrato/Chorus modulation. Higher values mean greater pitch and volume modulation.

AMS [List of AMS Sources]

This selects an AMS source to modulate the **Depth**. For a list of AMS sources, see “Alternate Modulation Source (AMS) List” on page 903.

Intensity [-100...+100]

This controls the depth and direction of the AMS modulation for **Depth**.

Speed [0.2Hz...20Hz]

This controls the speed of the Vibrato/Chorus LFO.

0 is 0.02Hz; 230 is 20 Hz; and 180 is 7Hz. Try around 179 for the magic C3 frequency.

AMS [List of AMS Sources]

This selects an AMS source to modulate the **Speed**. For a list of AMS sources, see “Alternate Modulation Source (AMS) List” on page 903.

Intensity [-20Hz...0Hz...+20Hz]

This controls the depth and direction of the AMS modulation for **Speed**.

7-1f: Main Output**Output Level** [000...127]

This controls the overall output level, after the Amp section and the Expression controls. In other words, this affects only the volume of the sound, and not the tonal character.

AMS [List of AMS Sources]

This selects an AMS source to modulate the **Output Level**. For a list of AMS sources, see “Alternate Modulation Source (AMS) List” on page 903.

Intensity [-127...+127]

This controls the depth and direction of the AMS modulation for **Output Level**.

Pan [Random, L001...C064...R127]

This controls the stereo pan of the organ. A setting of **L001** places the sound at the far left, **C064** in the center, and **R127** to the far right.

When this is set to **Random**, the Pan position will change at each note-on. Note that all notes of the CX-3 share the same Pan value, and will move together to the new position.

MIDI You can also control pan via MIDI Pan (CC#10). A CC#10 value of 0 or 1 places the sound at the far left, 64 places the sound at the location specified by the **Pan** parameter, and 127 places the sound at the far right.

Note: you can select Random pan only from the on-screen UI, and not from MIDI. This is controlled on the global MIDI channel (GLOBAL 1-1a).

AMS [List of AMS Sources]

This selects an AMS source to modulate Pan. Note that all notes of the organ share the same Pan value. For a list of AMS sources, see “Alternate Modulation Source (AMS) List” on page 903.

Intensity [-99...+99]

This controls the depth and direction of the AMS modulation for Pan.

✓ **7-1: Page Menu Commands**

- Compare →p.112
- Write Program →p.112
- Exclusive Solo →p.113
- PAGE →p.126
- MODE →p.126

7-2: Rotary Speaker



7-2a: Rotary Speaker

Important: To use the Rotary Speaker, the **Amp Type** must be set to Type 1 or Type 2. If it’s set to Pre Amp, the Rotary Speaker is disabled. For more information, see “Amp Type” on page 197.

Rotary On [Off, On]

This enables and disables the Rotary Speaker. It’s different from simply stopping the rotation (which you can do with the **Mode** parameter, below); instead, this is like unplugging the organ from the rotary speaker entirely.

When the Rotary Speaker is turned off, the tone is determined by the **Rotary Speaker Off Output** parameter, below.

AMS [List of AMS Sources]

This selects an AMS source to turn the Rotary Speaker on or off.

AMS Mode [Momentary, Toggle]

This determines the behavior of the Rotary Speaker on/off AMS. For details, see “AMS Mode” on page 189.

Rotary Speaker Off Output [Pre-Crossover, Post-Crossover]

This determines the sound when the Rotary Speaker is turned Off, above. It also determines the “dry” signal in the Wet/Dry mix; for details, see “Wet/Dry” on page 200.

Post-Crossover is the default, and matches the CX-3. With this setting, the speaker simulator and speaker crossover will still be active, even when the Rotary Speaker is disabled. Use this if you like the CX-3 sound, and are *not* sending the organ through a separate Rotary Speaker in the Insert Effects.

Pre-Crossover yields a tone without the effects of the speaker simulator and crossovers. Use this setting if you’ll be sending the organ through a separate Rotary Speaker in the Insert Effects.

Wet/Dry [Dry,1:99...99:1,Wet]

This adjusts the balance between the dry signal coming into the Rotary Speaker and the output of the effect.

The “dry” signal is either the pre-crossover or post-crossover input, as selected by the **Rotary Speaker Off Output** parameter; for more information, see “Rotary Speaker Off Output” on page 199.

AMS [List of AMS Sources]

This selects an AMS source to modulate the Wet/Dry mix. For a list of AMS sources, see “Alternate Modulation Source (AMS) List” on page 903.

Intensity [-100...+100]

This controls the depth and direction of the Wet/Dry AMS modulation.

7-2b: Mode/Speed

Mode

Mode Switch [Rotate, Stop]

This lets you stop the motion of the Rotary Speaker. Even when stopped, the speaker will still affect the timbre.

The horn and rotor can each take different amounts of time to start and stop their rotation. For more information, see “7-2c: Horn” on page 200 and “7-2d: Rotor” on page 201.

AMS [List of AMS Sources]

This selects an AMS source to start and stop the Rotary Speaker.

AMS Mode [Momentary, Toggle]

This determines the behavior of the Mode switch AMS. For details, see “AMS Mode” on page 189.

Speed

Speed SW [Fast/Slow]

The Rotary Speaker has two basic speeds, and this allows you to switch between the two. You can set the speeds of the horn and rotor sections separately for both the Fast and Slow settings, as well as the time that it takes them to speed up and slow down. For more information, see “7-2c: Horn” on page 200 and “7-2d: Rotor” on page 201.

AMS [List of AMS Sources]

This selects an AMS source to switch between the Slow and Fast speeds.

We’ve added a special trick for controlling Rotary **Speed** with JS X (left-to-right movement, which normally controls pitch bend). When **Speed SW AMS** is set to **JS X**, the joystick works like the speaker speed switch on a vintage organ. Move it to the left for Chorale (slow) and to the right for Tremolo (fast).

Note that this applies only when **JS X** is selected directly as the AMS source. If it is routed through an AMS Mixer, for instance, it is handled as if it were a normal modulation source.

AMS Mode [Toggle, Momentary]

This determines the behavior of the Speed switch AMS. For details, see “AMS Mode” on page 189.

Fast Overrides Stop [Off, On]

When this is enabled, switching the **Speed** to **Fast** via AMS will always push the Rotary Speaker into Fast mode - even if it had previously been stopped. Switching the **Speed** back to **Slow** will stop it again.

When Fast Overrides Stop is disabled, if the speaker is stopped, it will stay stopped regardless of Speed AMS.

7-2c: Horn

The Horn carries the high frequencies of the Rotary Speaker. You can independently control the Slow and Fast speeds of the horn, as well as the time it takes to speed up or slow down. You also have separate control over the amount of time that the horn takes to stop rotating entirely, and the time that it takes to resume rotation after being stopped.

Fast Speed [000...100]

This specifies the speed of the Horn when the **Speed Switch** is set to **Fast**.

Slow Speed [000...100]

This specifies the speed of the Horn when the **Speed Switch** is set to **Slow**.

Acceleration [000...100]

This sets how long it takes the Horn to change from the **Slow** speed to the **Fast** speed.

Deceleration [000...100]

This sets how long it takes the Horn to change from the **Fast** speed to the **Slow** speed.

Start Acceleration [000...100]

This sets how long it takes the Horn to come up to speed after the **Mode Switch** has changed from **Stop** to **Rotate**.

Stop Deceleration [000...100]

This sets how long it takes the horn to come to rest after the **Mode Switch** has changed from **Rotate** to **Stop**.

Mic Distance [000...100]

The Rotary Speaker model includes two pairs of stereo mics - one pair for the Horn, and the other for the Rotor. This parameter adjusts the distance between the Horn and its microphones. Lower values bring the mics closer to the speaker.

Mic Spread [000...100]

This adjusts the distance between the two Horn microphones, to widen the stereo field. Higher values increase the stereo effect.

Stop Phase [degrees] [Free, -180...+180]

When the **Mode Switch** is set to **Stop**, the Horn gradually comes to rest pointing one way or another. This allows you to control where it will stop.

Free lets it come to rest naturally, at a more or less random spot. The other settings, **-180** to **+180**, let you force it to land in a specific position.

The speaker position has a dramatic effect on the tone, so specifying a fixed position allows you to achieve consistent timbral results.

7-2d: Rotor

The rotor carries the low frequencies of the Rotary Speaker. Its parameters are identical to those of the Horn, above.

Fast Speed [000...100]

This specifies the speed of the Rotor when the **Speed Switch** is set to **Fast**.

Slow Speed [000...100]

This specifies the speed of the Rotor when the **Speed Switch** is set to **Slow**.

Acceleration [000...100]

This sets how long it takes the Rotor to change from the **Slow** speed to the **Fast** speed.

Deceleration [000...100]

This sets how long it takes the Rotor to change from the **Fast** speed to the **Slow** speed.

Start Acceleration [000...100]

This sets how long it takes the Rotor to come up to speed after the **Mode Switch** has changed from **Stop** to **Rotate**.

Stop Deceleration [000...100]

Specifies the time it will take for the Rotor to actually come to rest after rotation is switched off.

This sets how long it takes the Rotor to come rest after the **Mode Switch** has changed from **Rotate** to **Stop**.

Mic Distance [000...100]

This adjusts the distance between the Rotor and its microphones. Lower values bring the mics closer to the speaker.

Mic Spread [000...100]

This adjusts the distance between the two Rotor microphones, to widen the stereo field. Higher values increase the stereo effect.

Stop Phase [degrees] [Free, -180...+180]

This determines where the Rotor will land when the Mode Switch is set to Stop. For more details, see “Stop Phase [degrees],” above.

7-2e: Balance and Speaker Simulator

Horn/Rotor Balance [Rotor, 1...99, Horn]

This sets the output balance between the high frequencies of the Horn and the low frequencies of the Rotor.

Speaker Simulator [Off, On]

This enables and disables modeling of the speaker tone.

Note: The **Speaker Simulator** may still affect the tone even when the Rotary Speaker is turned off, depending on the setting of the **Rotary Speaker Off Output** parameter. For more information, see “Rotary Speaker Off Output” on page 199.

Speaker Type [CX-3, Natural, Natural + Direct, Resonant, Resonant + Direct, Bright, Bright + Direct]

Speaker Type only appears when the **Amp/VC/Rotary Mode** is set to **Custom** (see “Amp/VC/Rotary mode” on page 187). This selects the model used for the **Speaker Simulator**, and can have a significant effect on the overall tone—particularly noticeable at fast rotary speeds.

 **Important:** Some **Speaker Types** have sharp resonances in their frequency responses which may cause higher volumes with specific notes and drawbar settings. If the volume is already high, this can cause clipping at the outputs. If this happens, simply turn down the **Output Level** in the Main Output section on the Amp/Vibrato/Chorus page.

CX-3: This is the same as the original CX-3 speaker simulator.

Natural: This is based on new analysis of a classic vintage rotary speaker.

Natural + Direct: This is similar to **Natural**, but with a bit of the direct signal mixed back in - resulting in greater extension of both high and low frequencies.

Resonant: This has more mid-frequency bite than **Natural**, similar to a popular rotary speaker effects pedal.

Resonant + Direct: Similar to **Resonant**, but with a bit of direct signal mixed in (see **Natural + Direct** above).

Bright: Based on **Natural**, but with less high-end roll-off for a brighter sound.

Bright + Direct: Like **Bright**, but with a bit of direct signal mixed in (see **Natural + Direct** above).

✓ 7-2: Page Menu Commands

- Compare →p.112
- Write Program →p.112
- Exclusive Solo →p.113
- PAGE →p.126
- MODE →p.126

PROGRAM > CX-3: AMS Mixer

The AMS Mixers combine two AMS sources into one, or process an AMS source to make it into something new.

For instance, they can add two AMS sources together, or use one AMS source to scale the amount of another. You can also use them to modify the response of realtime controllers.

The AMS Mixer outputs appear in the list of AMS sources, just like other controllers.

This also means that the original, unmodified inputs to the AMS Mixers are still available as well. For instance, if you use **Velocity** as an input to a AMS Mixer, you can use the processed version of the **Velocity** to control one AMS destination, and the original version to control another.

Finally, you can cascade the two AMS Mixers together, by using AMS Mixer 1 as an input to AMS Mixer 2.

9-1: AMS Mixer

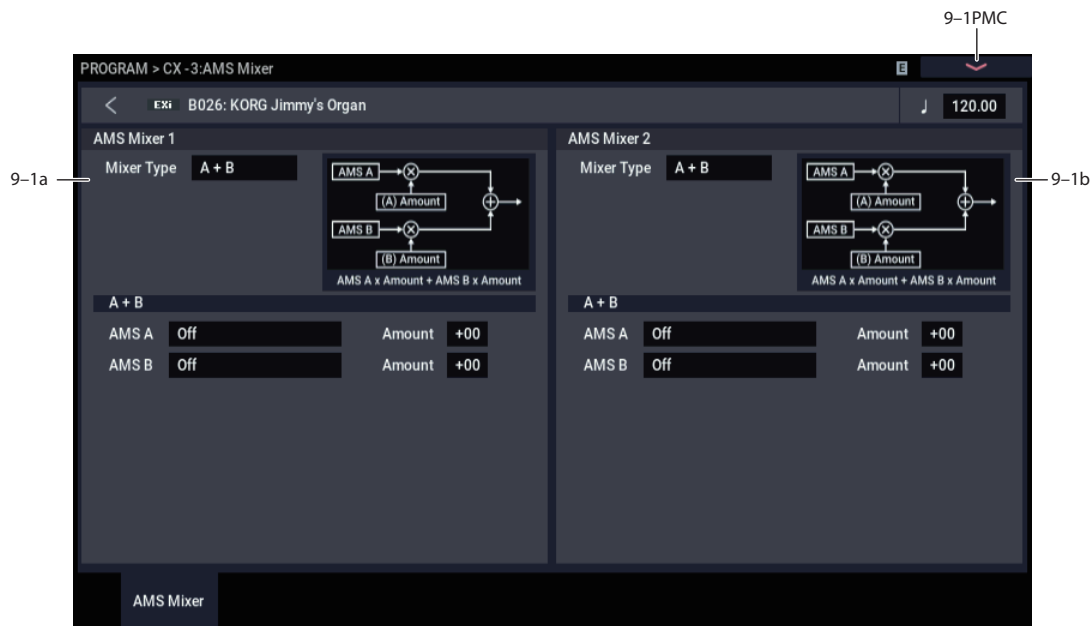

9-1a: AMS Mixer 1 AMSource

Mixer Type [A+B, Amt Ax B, Offset, Smoothing, Shape, Quantize]

This controls the type of processing performed by AMS Mixer 1.

A+B adds two AMS sources together. For more information, see “A+B” on page 90.

Amt Ax B scales the amount of one AMS source with the other. See “Amt A x B” on page 90 for more details.

Offset adds or subtracts a constant value to or from an AMS source. For more information, see “Offset” on page 91.

Smoothing creates more gentle transitions between values, smoothing out abrupt changes such as a quick move on a joystick or a sharp edge on an LFO. For details, see “Smoothing” on page 92.

Shape adds curvature to the AMS input. For an in-depth description, see “Shape” on page 92.

Quantize turns smooth transitions into discrete steps. See “Quantize” on page 93 for more information.

Gate chooses between two AMS inputs (or fixed values) based on a third AMS source. See “Gate” on page 93 for more information.

9-1b: AMS Mixer 2 AMSource

This is the second AMS Mixer. Its parameters are exactly the same as those of AMS Mixer 1, above.

✓ 9-1: Page Menu Commands

- Compare →p.112
- Write Program →p.112
- Exclusive Solo →p.113
- PAGE →p.126
- MODE →p.126

CX-3: Tone Adjust

CX-3 Tone Adjust Default Settings

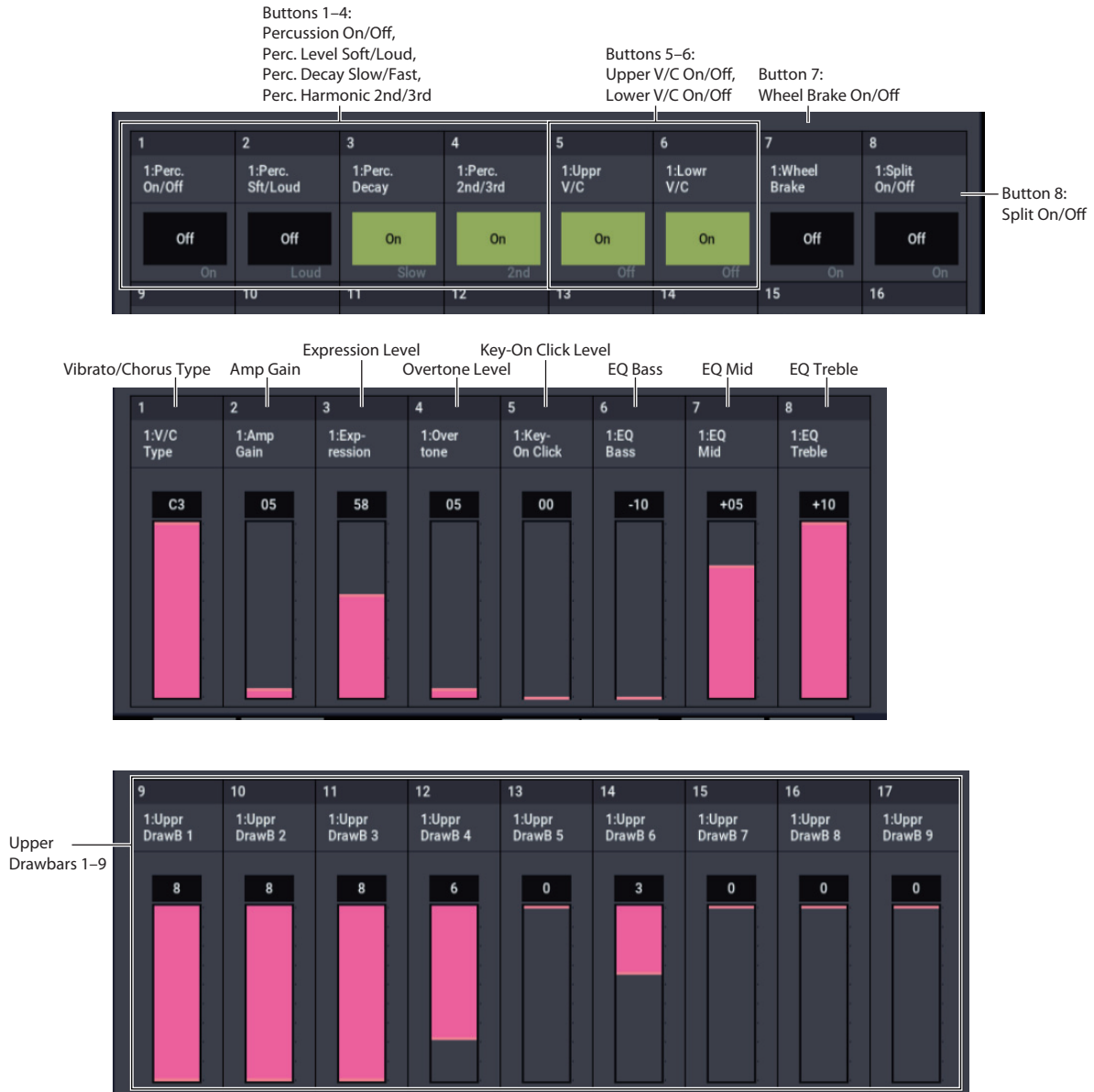

Tone Adjust provides an elegant physical interface to the CX-3's parameters. Most of the factory sounds use the default layout, as shown above.

You can also customize the layout for individual sounds, if desired. For instance, most of the factory sounds use the sliders for the upper drawbars; if you like, you can re-assign them to the lower drawbars instead.

For more information about Tone Adjust, please see "0-9a: Tone Adjust," on page 29.

CX-3 Tone Adjust parameters

The CX-3 is substantially different from other EXi instruments, so it does not support the Common Tone Adjust parameters. Instead, it adds a number of its own, unique parameters, as described below.

All of these parameter are absolute, which means that they over-write the stored parameter values.

Note that these controls are separate for each EXi, as opposed to being shared by both EXi in the Program.

Drawbars

- Upper Drawbars 1-9
- Lower Drawbars 1-9
- Upper EX Drawbars 1-4
- Lower EX Drawbars 1-4
- Noise level
- Leakage level
- Wheel Brake
- Overtone Level
- Key-On Click Level

Percussion

- Percussion On/Off
- Level Soft/Loud
- Decay Slow/Fast
- Harmonic 2nd/3rd
- EX Percussion levels 1-5

Vibrato/Chorus

- Vibrato/Chorus Type
- Upper Drawbars V/C On/Off
- Lower Drawbars V/C On/Off

Expression

- Expression Level

Amp

- Amp Gain
- EQ Bass
- EQ Mid
- EQ Treble

Split

- Split On/Off

Rotary Speaker

- On/Off
- Rotate/Stop
- Slow/Fast

Changes from the original CX-3

With the NAUTILUS CX-3, Korg has taken the original, ground-breaking CX-3 model and made it even better. If you'd like to convert sounds from the original CX-3, the following notes describe these changes in detail.

Noise Level range improved

The Noise Level parameter now offers more fine control over the most useful range of values. When converting sounds, multiply the original CX-3 Noise Level by 10.

EX Mode enhanced

On the original CX-3, there were four global settings for the EX Mode drawbar frequencies. The NAUTILUS CX-3 offers four global presets, which match the factory defaults of the original CX-3, and then also allows you to set different frequencies for each Program if desired.

The range of the EX drawbar pitches has also been extended to go all the way down to 16', in semitone steps.

Finally, the NAUTILUS CX-3 supports keyboard splits with full EX drawbars on both upper and lower sides of the split.

Split Transpose increased

You can now transpose both sides of the split up or down by up to two octaves, for more flexible zoning on larger keyboards (such as 73- and 88-key instruments).

Expression parameters per-Program

The expression-related parameters can be set separately for each Program.

Percussion for either lower or upper drawbars

The percussion can be assigned to either the lower or upper drawbars, instead of just the upper drawbars. This allows you to play a bass line with percussion, as in ELP's "Tarkus."

Percussion parameters changed to absolute values

Instead of relative offsets, you can directly set the values for Percussion Slow and Fast Decay, and Percussion Loud and Soft.

Vibrato Chorus custom mode added

In addition to the six traditional presets, you can create your own custom settings, which can then be modulated via AMS.

Rotary Speaker Mic Modeling

For consistency with the rest of the NAUTILUS, the value ranges of the mic modeling parameters have been changed slightly. On the original CX-3, they were 0-99; in the NAUTILUS, they are 0-100.

Additionally, the parameter ranges of the Horn and Rotor Mic Distance parameters are reversed. To convert these parameters from the original CX-3, use the following formula:

Mic Distance = 100-(original CX-3 mic distance)

Rotary Speaker Acceleration and Deceleration

The Rotary Speaker Acceleration/Deceleration parameters were named "Transit" on the original CX-3. To be consistent with the rest of the system, the NAUTILUS values range from 0 (slowest) to 100 (fastest), while the original CX-3 went from 99 (slowest) to 0 (fastest).

Additionally, for the Horn only, the maximum acceleration, deceleration, start, and stop rates have been increased to about twice that of the original CX-3. The minimum rates are still the same.

To convert settings from the original CX-3 Horn "Transit" parameters, use the following formula, rounding as necessary:

NAUTILUS value = (100 - (original CX-3 value))/100 x 52

In other words, the NAUTILUS value range of 52...0 is equivalent to the original CX-3 range of 0...99, and NAUTILUS values 53 and higher are all faster than the original CX-3.

To convert settings from the original CX-3 Rotor "Transit" parameters, the formula is:

NAUTILUS value = 100 - (original CX-3 value)

Rotary Speaker Stop Phase added

You can now set the phase at which the Horn and Rotor will settle when the Rotary Speaker stops.

EXi CX-3: Page Menu Commands

| | |
|----------------|--------|
| Compare | →p.112 |
| Write Program | →p.112 |
| Exclusive Solo | →p.113 |
| Copy Drawbars | →p.206 |
| Swap Drawbars | →p.206 |
| PAGE | →p.126 |
| MODE | →p.126 |

Copy Drawbars

This copies drawbar or EX drawbar settings within the CX-3 oscillator.

1. Select “Copy Drawbars” to access the dialog box.

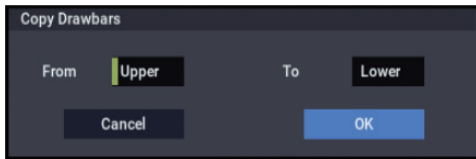

2. Use the “From” field to specify the copy-source drawbars.
3. Use the “To” field to specify the copy-destination drawbars.
4. Press the OK button to execute the Copy Drawbars operation. If you decide to cancel, press the Cancel button.

Swap Drawbars

This exchanges drawbar or EX drawbar settings within the CX-3 oscillator.

1. Select “Swap Drawbars” to access the dialog box.

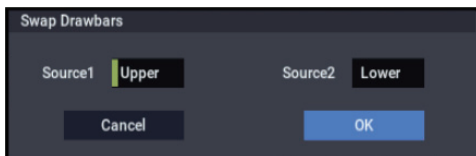

2. Use the “Source1” and “Source2” fields to specify the two sets of drawbars you want to exchange.
3. Press the OK button to execute the Swap Drawbars operation. If you decide to cancel, press the Cancel button.

EXi: STR-1 Plucked String

STR-1 Overview

The STR-1 Plucked String offers a comprehensive and sophisticated set of physical modeling synthesis tools, capable of creating both traditional sounds (acoustic and electric guitars and basses, clavichets and harpsichords, harps, bells, electric pianos, ethnic instruments, etc.) and unique, experimental timbres.

Some of the feature highlights include:

- Physically modeled string, including damping, decay, dispersion, nonlinearity, and harmonics
- String excitation via a selection of “pluck” types, a noise generator with saturation and dedicated filter, and any mono samples from ROM, EXs, SAMPLING mode, or User Sample Banks (using Korg’s ultra-low-aliasing PCM oscillator, as first introduced in the HD-1)
- Dual multi-mode resonant filters (including Korg’s Multi Filter, as first introduced in the AL-1), plus an additional multi-mode resonant filter dedicated to the string excitation
- Live audio input, including modeled feedback
- Up to 40-voice polyphony
- Four per-voice LFOs, five re-triggerable EGs, two key tracking generators, a string tracking generator, and four AMS mixers
- Access to all standard EXi Program features, including the Common LFO, Common Step Sequencer, Key Track 1 & 2, Arpeggiator, EQ, and effects—as well as layering with any other EXi (including using two STR-1s together!)

STR-1 Overview

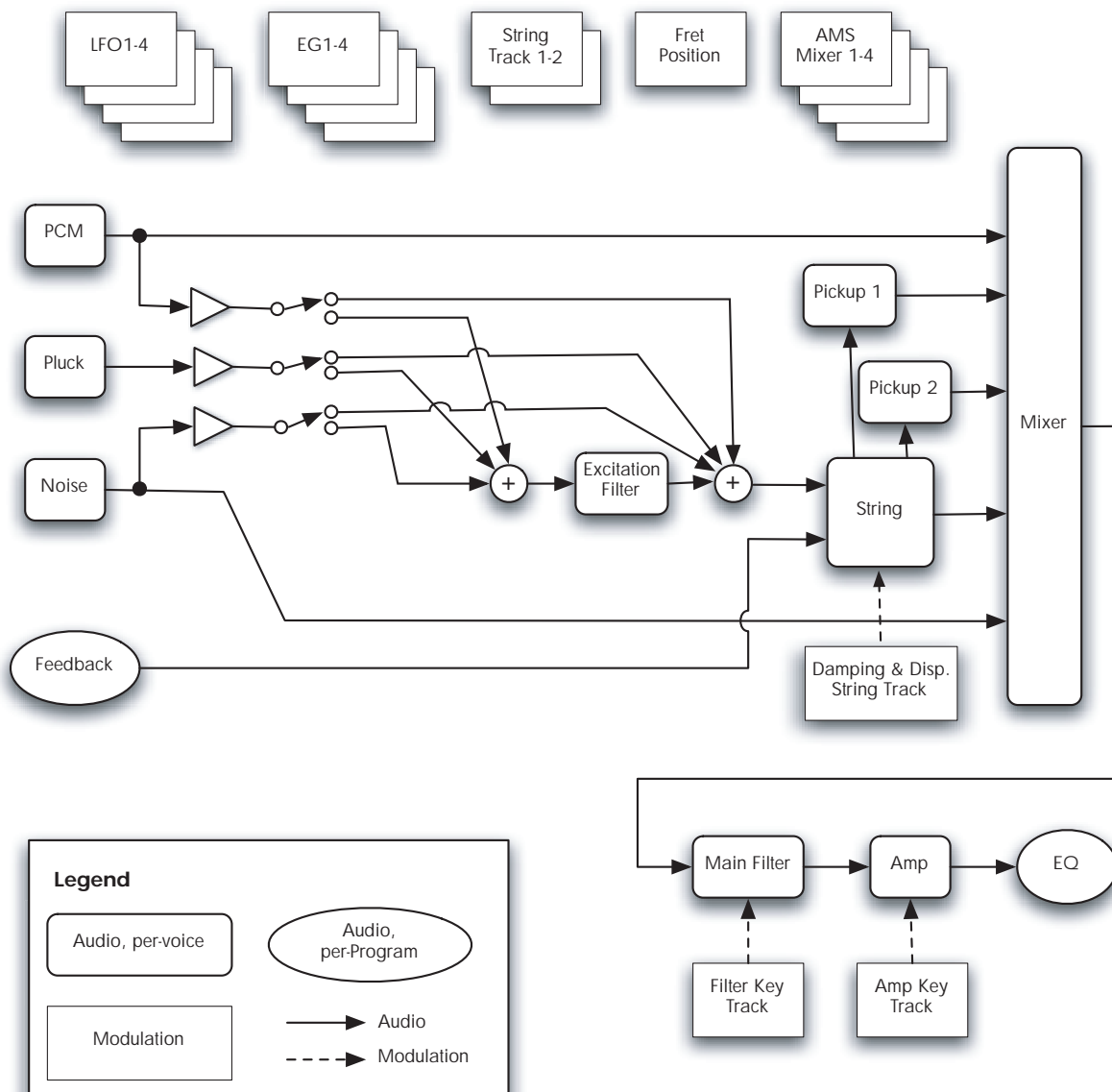

STR-1 uses EXi fixed resources

The STR-1 uses EXi fixed resources for its modeled feedback. This uses up a small amount of processing power, even if you're not playing any notes.

Because of this, you can use only sixteen STR-1s simultaneously in a Combination or Song. If other EXis with fixed resources are in use, the maximum number of STR-1s will be reduced accordingly. Each EXi in each Program counts towards the maximum; for instance, a Program with two STR-1s counts as two, not as one.

For more information, see "CX-3 & other EXi: Limitations on EXi fixed resources" on page 380.

Unsupported EXi Common parameters

The STR-1 supports all of the EXi Common parameters, except for two of the voice allocation options: **Poly Legato** and **Mono Mode** (Normal/Use Legato Offset).

All of the other voice allocation options are fully supported, including Mono, Mono Legato, Unison, etc.

EXi PROGRAM > STR-1: Home

0-1: Overview

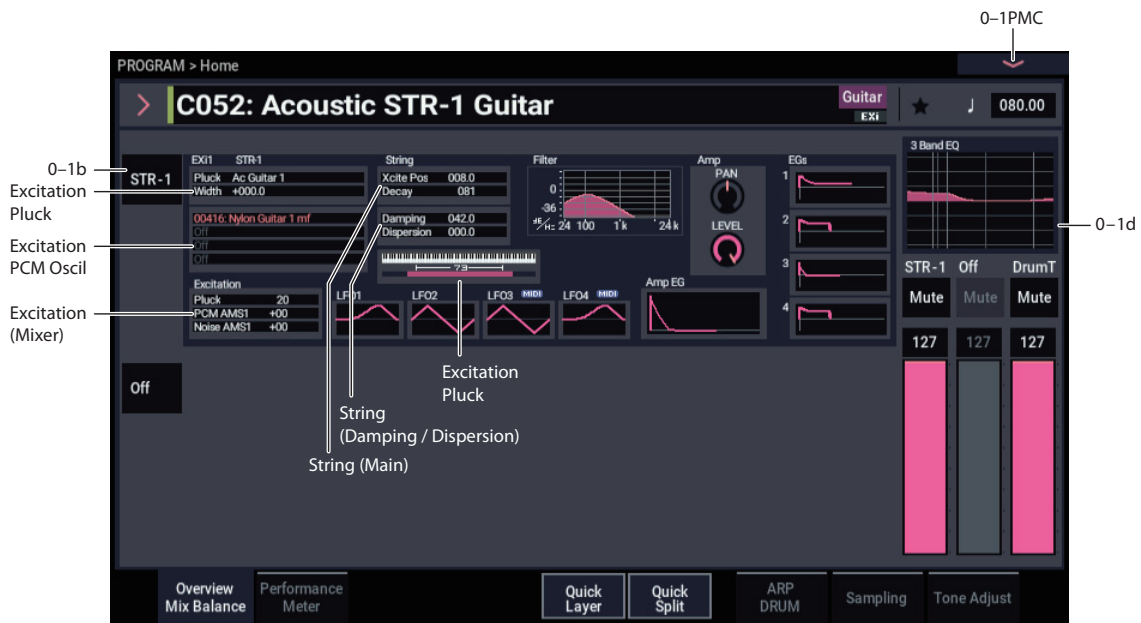

This is the main page of PROGRAM mode. For a full description of this page and all of its functions, please see “EXi PROGRAM > Home” on page 127. This section describes only the overview display, which differs for each individual EXi.

0-1b: Overview and Page Jump

This part of the page shows an overview of the most important settings for the Program’s two EXi instruments. The specific parameters will vary, depending on which EXi are being used. The specific parameters for the STR-1 are described below.

The graphics give you a quick way to check all of these settings at a glance. They also let you jump instantly to any of the displayed parameters. Just touch one of the sections, and you’ll jump to the page containing its parameters. For instance, if you touch the Filter EG graphic, you’ll go to the Filter EG page.

Tip: Pressing EXIT several times will always bring you back to this page.

STR-1

Excitation

Pluck

This area shows the selected **Pluck Type** and **Width**.

Touch this area to jump to the STR-1: String– Pluck/Noise page.

PCM Oscillator

This area shows the four Multisamples selected for the PCM Oscillator. Colors are used to distinguish between the various possibilities, as detailed below.

- Red: ROM, EXs, and User Sample Bank Multisamples

- White: SAMPLING mode Multisamples
- Grey: Off

Touch this area to jump to the STR-1: Strings– PCM OSC page.

Excitation (Mixer)

This shows the excitation **Level** for the Pluck, and the **AMS1 Intensities** for the Noise Generator and PCM Oscillator (since these levels will often be controlled completely via AMS).

Touch this area to jump to the STR-1: Strings– Excitation Mixer page.

String

String Main

This shows the **Excitation Position** and **Decay** settings for the string.

Touch this area to jump to the STR-1: Strings– String Main page.

Damping and Dispersion

This shows the **Damping** and **Dispersion** settings for the string.

Touch this area to jump to the STR-1: Strings– Damping and Dispersion page.

Output

Filter

This shows a graphic representation of the filter frequency response, including cutoff and resonance.

Press this area to jump to the STR-1: Filter– Basic page.

Amp

This shows the Amp section's **Pan** and **Amp Level** values.

Press this area to jump to the STR-1: Amp page.

EGs and LFOs

EG 1...4, Amp EG Graphics

These show the shapes of the five EGs. Touch any of them to jump directly to the corresponding edit page.

LFO 1, 2, 3, 4 Graphic

These show the waveforms and shapes of the four LFOs. Touch any of them to jump directly to the corresponding edit page.

Key Zone

Key Zone

This shows the key zones for EXi1 and EXi2, as set on the Common section's Program Basic page, in relation to the entire MIDI note range. The range of the 61-, 73-, or 88-note keyboard is also shown, as appropriate.

Press this area to jump to the PROGRAM > Basic/X-Y/Controllers- Program Basic page.

0-1d: Common

3Band EQ Graphic

| | |
|-------------------------------|--------------------|
| Mute (1) | [On, Off] |
| Mute (2) | [On, Off] |
| Mute (DrumT) | [On, Off] |
| EXi1 Instrument Volume | [000...127] |
| EXi2 Instrument Volume | [000...127] |
| Drum Track Volume | [000...127] |

This is the same as with HD-1 programs. For more information, please see "0-1d: Common" on page 4.

✓ 0-1: Page Menu Commands

- Compare →p.112
- Write Program →p.112
- Exclusive Solo →p.113
- Show MS/WS/DKit Graphics →p.113
- Add To Set List →p.113
- Initialize Program →p.113
- PAGE →p.126
- MODE →p.126

PROGRAM > STR-1: String

4-1: Pluck/Noise

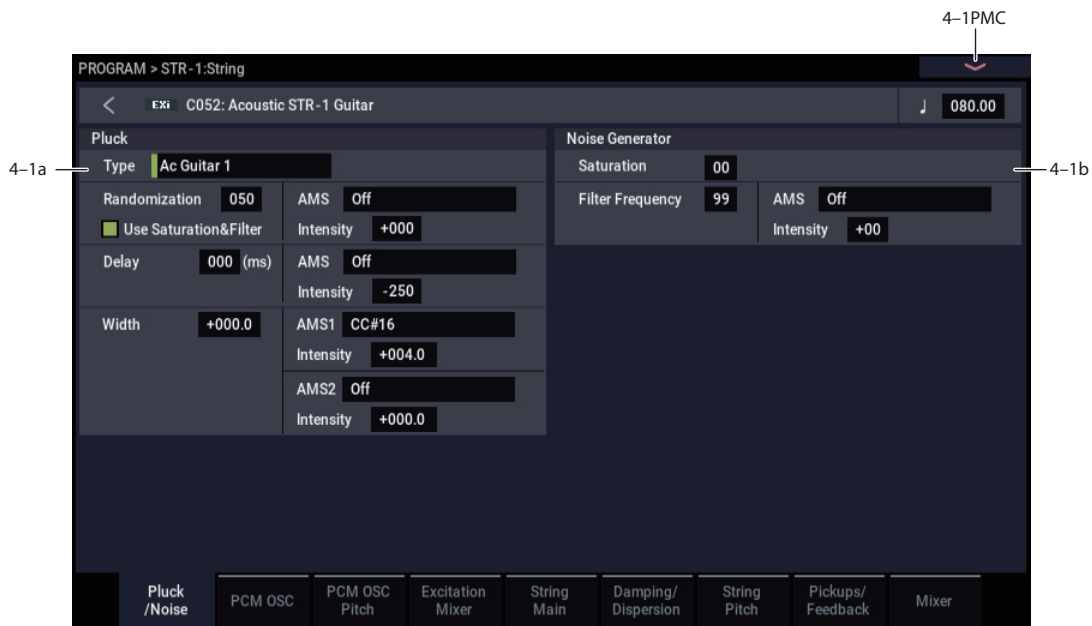

4-1a: Pluck

Type [Ac Guitar 1...Harpichord]

This selection models different types of plucking actions, including picks and finger-plucking. The pluck type sets the basic tone of the plucked string.

You can also “pluck” the string using the Noise Generator, as well as PCM samples. You can even combine all three types of excitation together, to create specific tones.

Ac Guitar 1. This type is a little unusual, in that it includes the “pluck position” in the pluck sound itself. Because of this, it’s probably best to set the **Excitation Position Tone** to 0, so that the **Excitation Position** itself has no effect. (For more information, see “Tone” on page 222.)

Ac Guitar 2. This is similar to A. Guitar 1, but does not include the “pluck position” in the sound. As with most of the other types, it will generally work better with **Excitation Position Tone** set to -100.

Dark E. Guitar, Bright E. Guitar, Resonant E. Guitar, Dark Jazz Guitar, Bright Jazz Guitar, Brighter Jazz Guitar. With all of the E. Guitar and Jazz Guitar pluck types, set the **Excitation Position** between 5 and 35.

Square Pluck. With randomization turned up, this sounds like bright clav or harpsichord.

Midrange Pluck. This is similar to Square Pluck, but with more midrange harmonics.

Smooth Pulse. This has very few harmonics, for a mellow and full tone.

Resonant Pulse. This is similar to Smooth Pulse, but brighter and more resonant.

Dark Clav, Midrange Clav, Bright Clav. These offer variations on clavinet sounds.

Harpichord. This type includes small amount of noise before the main pluck.

Randomization [0...100]

This adds a small amount of variation to each strike of the pluck, by adding in a small amount of the Noise Generator’s output. The tone of the randomization is affected by the **Use Saturation & Filter** parameter, below.

Use Saturation & Filter [Off, On]

This controls whether or not **Randomization**, above, is affected by the Noise Generator’s **Saturation** and **Filter Frequency** parameters.

To use simple white noise for the **Randomization**, which will generally yield the brightest pluck timbre, turn this **Off** (un-checked).

AMS [List of AMS Sources]

This selects a modulation source to control the **Randomization**. For a list of AMS sources, see “Alternate Modulation Source (AMS) List” on page 903.

Intensity [-100...+100]

This controls the depth and direction of the **Randomization** AMS modulation.

Delay (milliseconds) [0...250]

You can delay the Pluck by up to 250ms after the initial note-on. This lets you create double-strike effects and complex attacks. For instance, try using an envelope with a slow attack time to control the volume or filter cutoff of the PCM Oscillator or Noise Generator, and then combining this with a delayed Pluck.

AMS [List of AMS Sources]

This selects a modulation source to control the **Delay**. For a list of AMS sources, see “Alternate Modulation Source (AMS) List” on page 903.

Intensity [-250...+250]

This controls the depth and direction of the **Delay** AMS modulation.

Width [-100.0...+100.0]

This models the time that the pick is in contact with the string, which is a combination of the size and thickness of the pick, and the speed at which the pick is moving.

The width adjusts the tone of the initial string excitation; low settings emphasize lower frequencies, and high settings emphasize high frequencies.

To put it another way, **-100.0** is very “wide,” and **+100.0** is very narrow.

Low or negative width settings may cause thumpiness at the high end of the keyboard, but this can be solved using a number of different techniques. For more information, see “Tips for avoiding “thumpy” excitation,” below.

AMS 1 [List of AMS Sources]

This selects the first modulation source to control the **Width**. For a list of AMS sources, see “Alternate Modulation Source (AMS) List” on page 903.

Intensity [-100.0...+100.0]

This controls the depth and direction of the **Width** AMS modulation.

AMS 2 [List of AMS Sources]

This selects the second modulation source to control the **Width**. For a list of AMS sources, see “Alternate Modulation Source (AMS) List” on page 903.

Intensity [-100.0...+100.0]

This controls the depth and direction of the second **Width** AMS modulation.

Tips for avoiding “thumpy” excitation

To avoid low-end “thumps” at the top end of the keyboard:

- Make sure the duration of the excitation input is about the same as one period of the waveform. To do this when using the Pluck as the excitation, you’ll probably need to use note number or Key Tracking to scale the **Pluck Width** so that it gets more narrow (higher values) as you play higher on the keyboard.
- Similarly, when using the PCM oscillator or noise generator as the excitation, use an EG to control the level at the Excitation mixer (or the cutoff of the Excitation Filter), and then scale the EG times so that they become shorter as you play higher on the keyboard.
- Try setting the **Excitation Position Tone** to **-100**.
- In the main mixer, use the pickups instead of the direct string output.
- Set the **Excitation Filter Type** to **Highpass**, and track its cutoff frequency with Note Number.
- Set the main **Filter Type** to **Highpass**, and track its cutoff frequency with Note Number. If you are using Filter A as a lowpass filter, set the **Routing** to **Serial** and then make Filter B the highpass filter.

4-1b: Noise Generator

The noise generator includes **Saturation**, for creating unique and chaotic noise effects, and a dedicated 1-pole filter to control noise color.

For standard white noise, set the **Saturation** to **0**, and the **Filter Frequency** to **99**.

For colored noise (such as pink noise), set the **Saturation** to **0**, and reduce the **Filter Frequency** as desired.

To create “speckled noise” such as rocket sounds and thunder, set **Saturation** to **99**, and **Filter Frequency** to **10**.

To create key contact noise (such as you might find on vintage analog synths), create speckled noise as described above, and then use a fast EG to control its volume in the mixer.

Saturation [0...100]

This control clips the noise signal, for added crunch. Subtle variations in saturation are more noticeable with very low **Filter Frequency** settings (see below), allowing you to create organic, rumbling timbres.

Filter Frequency [0...100]

This is a simple, 1-pole lowpass filter for controlling the “color” of the noise.

AMS [List of AMS Sources]

This selects the first modulation source to control the noise generator’s **Filter Frequency**. For a list of AMS sources, see “Alternate Modulation Source (AMS) List” on page 903.

Intensity [-100...+100]

This controls the depth and direction of the **Filter Frequency** AMS modulation.

✓ 4-1: Page Menu Commands

- Compare →p.112
- Write Program →p.112
- Exclusive Solo →p.113
- PAGE →p.126
- MODE →p.126

4-2: PCM OSC



Using PCM in the STR-1

Using PCM samples to “pluck” the string

In addition to the Pluck and the Noise Generator, you can also “pluck” the string with PCM samples. In general, this will work best if you use a fast envelope to control the level of the PCM in the Excitation Mixer, so that it becomes just a short attack transient.

For instance:

1. Follow the steps under “Creating an initialized STR-1 Program” on page 214.
2. Press the EX1 1 tab, to get to the STR-1 parameters.
3. Go to the PROGRAM > STR-1: String– Excitation Mixer page.
4. Set the PCM Level AMS 1 source to EG 3, and the AMS1 Intensity to 50.
5. Go to the PROGRAM > STR-1: EG– EG3 page.
6. Set the Start and Sustain Levels to 0, and the Attack and Break Levels to 99.
7. As a first pass, set the Attack Time to 0, the Decay Time to 10, and the Slope Time to 2.

With these settings, the **Attack Time** controls how fast the EG attacks, the **Decay Time** sets the duration, and the **Slope Time** controls the decay.

8. Use **Key Track** or **Note Number** to modulate the Decay time via AMS, so that it is shorter for higher notes, and longer for lower notes.

If you use looped PCM as the excitation, without EG control of the amplitude, it will tend to sound like bowing. In this case, using a bit of constant **Harmonic Pressure** can produce a good effect; among other things, this removes some energy from the string.

Using the string as a comb filter for PCM

You can use the string as a comb filter for the PCM Oscillator. To do so:

1. Follow the steps under “Creating an initialized STR-1 Program” on page 214.
2. Go to the PROGRAM > STR-1: String– PCM OSC page, set MS1 to use “Multisample Select” 00433 POWER SAW.

You can use this technique with any Multisample, but a sawtooth waveform will make the effect particularly clear.

3. On the PROGRAM > STR-1: String– Excitation Mixer page, set the Pluck Level to 0, and the PCM Level to 25.
4. On the PROGRAM > STR-1: EG– EG2(Pitch) page, set the Attack Time to 50, and the Decay Time to 70.
5. Set the Break and Sustain Levels to +25.
6. Set the Attack and Decay Curves to +5.
7. On the PROGRAM > STR-1: String– String Pitch page, in the EG section, set the Intensity to +36.00.

EG2 (Pitch) is already selected, by default. In this setup, the string’s pitch controls the frequency of the comb filter.

8. Play a note in the lower part of the keyboard.

Notice how the Program makes a sweeping sound, with some resemblance to oscillator sync. That’s the sound of the comb filter.

9. Experiment with the PROGRAM > STR-1: String– String Main page’s Decay parameter.

Decay controls the resonance of the comb filter.

10. Experiment with the Damping and Dispersion parameters.

These can change the character of the comb filter in interesting ways.

Layering PCM with modeled string timbres

You can also simply layer PCM samples with string timbres. To do so, set the **Filter Routing** to **Parallel**, and then use the Mixer page to route the PCM Oscillator to Filter A, and the String to Filter B (or vice-versa). For more information, see “5–1a: Routing” on page 234, and “4–9: Mixer” on page 232.

Creating an initialized STR-1 Program

For the examples above, it can be useful to start with the default STR-1 settings. To do so:

1. In **PROGRAM** mode, select **B067 Felix’sDaKat**.
2. Press the **PAGE** button, and then press the **Basic/X-Y/Controllers on Common**.
3. Under **EXi Instrument Type on Program Basic** page, select **STR-1 Plucked String**.

Now, you have an initialized STR-1 Program.

4–2a: Multisamples

This section selects the Multisamples to be used for the string excitation.

Velocity splits

As mentioned above, each Oscillator has four velocity zones, named MS1 (High) through MS4 (Low). Each of these zones can play a different Multisample, and has separate settings for Level, Start Offset, and so on.

Note that, unlike the HD-1, crossfades and layers are not supported.

-  No sound will be made if the selected EXs samples have not been loaded when saving the program. Also, the message “Samples Not Loaded” will appear at the top of the display. To resolve this issue, load the necessary EXs sample data.

MS1 (High)

These are the settings for the first and highest velocity zone.

If you want to create a simple setup with only a single Multisample, just set up MS1 as desired, and then set the **Bottom Velocity** to 1.

Type **[Off, Multisample]**

This selects whether MS1 will play a Multisample, or nothing at all. You can use this to disable any of the four Multisamples.

Bank **[List of Multisample Banks]**

There are four types of Multisample Banks: **ROM**, **SAMPLING mode**, **EXs**, and **User Sample Banks**.

ROM Multisamples are the built-in “factory” sounds, and are always available.

Smp (SAMPLING Mode) Multisamples are the ones that you can see and edit in SAMPLING mode. After the abbreviation “Smp,” several different things may appear, as described below.

Smp: Old RAM means that this is an older Program pointing to the legacy “RAM” bank. Instead of pointing to a specific User Sample Bank, it will use whatever Multisample data is loaded into SAMPLING mode.

Smp: New Sampling Session will appear when there’s data in SAMPLING mode which hasn’t yet been saved to drive as a User Sample Bank. For instance, this might happen if you’ve loaded an old KSC file, loaded individual Samples or Multisamples, or recorded some new samples. Once the KSC is saved to drive, the name will update to show the file path (as described below).

Smp: [file name] will appear when a User Sample Bank has been loaded into SAMPLING mode. The name is the file name itself along with those of all its enclosing folders.

EXs Multisample banks are PCM expansion sets created especially for the NAUTILUS. Each has its own unique number; for instance, EXs301: German2 D Piano, EXs302: Italian F Piano. Only the currently loaded EXs banks will appear on this menu.

User Sample Banks bring the benefits of EXs to your own sample libraries. You can load and play gigabytes of your custom or converted samples at once, using Virtual Memory. The name is shown as a path to the KSC file, including the file name and the names of all enclosing directories. Only the currently loaded User Sample Banks will appear in this menu.

If a sound refers to a User Sample Bank which is not on the internal drive(s), the name will appear as “Unknown Sample Bank [number]” when the bank select dialog is open, shortened to “??[number]” when the dialog is closed.

For more information, see “User Sample Banks” on page 151 of the OG.

-  Note that unlike the HD-1, you can only select mono Multisamples.

Multisample Select **[List]**

This parameter lets you select a Multisample for the velocity zone. You can use any mono Multisample, or the left or right channel of a stereo Multisample.

-  Some Multisamples may have an upper limit to their keyboard range, over which they may not produce any sound.

Note: If the stored selection uses EXs or User Sample Bank data which is not currently loaded, it will not make any sound. The message “Samples Not Loaded” will also appear at the top of the display. To fix this, load the required sample data.

Multisample Select menu

To select a Multisample:

1. Press the **Multisample Select** popup button to open the **Multisample select** menu.
2. Use the **tabs** to select a category and sub-category.
3. Select a **Multisample** from within that category/sub-category.
4. You can use the **Find** button to search for **Multisamples** by name.
For more information, see “Find dialog” on page 7.
5. Press the **OK** button to confirm your selection, or press the **Cancel** button to exit without making a change.

The list shows all of the mono Multisamples in the Bank. If the Bank contains stereo multisamples, you’ll also see the left and right channels as separate, mono multisamples, with -L and -R appended to the end of the name.

Reverse [Off, On]

This lets you play the selected multisample backwards, without looping.

Note: If the individual samples within a Multisample are already set to Reverse, they will still play in reverse, regardless of this setting.

On (checked): The Multisample will play back in reverse.

Off (unchecked): The Multisample will play back normally.

Level [0...127]

This sets the basic volume level of the multisample. Use this to adjust the balance between the four velocity zones.

The Excitation Mixer, main Mixer, and Amp sections can modify this basic level extensively with envelopes, LFOs, keyboard tracking, and other modulation; for more information, see “4-4: Excitation Mixer,” on page 219, “4-9: Mixer,” on page 232, and “6-1: Amp,” on page 242.

 Depending on the multisample, high **Level** settings may cause distortion when playing many notes at a time. If this occurs, lower the **Level**.

With SAMPLING mode Multisamples, each Sample also has a “+12dB” option. If this is turned on, the Sample will play back approximately 12dB louder. You can configure this parameter for each Sample in SAMPLING mode. For more information, see “+12dB” on page 590.

Start Offset [Off, 1st...8th]

In addition to simply starting playback from the beginning, ROM and EXs Multisamples can have up to 8 different pre-programmed alternate starting points.

Similarly, SAMPLING mode and User Sample Bank Multisamples can play either from the beginning of the waveform, or from the loop start point.

Start Offsets: ROM and EXs

With ROM and EXs Multisamples, the Start Offset specifies whether to use the normal start point (**Off**), or to use one of the alternate start points (**1st–8th**).

Some ROM and EXs Multisamples may have fewer than 8 pre-programmed points, in which case only the available points can be selected.

Start Offsets: SAMPLING mode and User Sample Banks

With SAMPLING mode and User Sample Bank Multisamples, only Off and 1st are available. **Off** uses the normal start point, and **1st** uses the loop start instead. **2nd** through **8th** will be grayed out.

Bottom Velocity [1...127]

This sets the lowest velocity at which the Multisample or will sound. MS1’s Bottom Velocity can be equal to, but not lower than, than that of MS2.

MS2...3 and MS4 (Low)

These are the settings for the remaining velocity zones. The parameters for MS2 and MS3 are exactly the same as those for “MS1 (High),” above.

The parameters for MS4 (Low) are also similar to those for MS1, except that MS4 has no setting for Bottom Velocity (which is always fixed at 1).

✓ 4-2: Page Menu Commands

- Compare →p.112
- Write Program →p.112
- Exclusive Solo →p.113
- Remap MS/Sample Banks →p.121
- PAGE →p.126
- MODE →p.126

4-3: PCM OSC Pitch



This section controls the pitch modulation for the PCM oscillator.

Important: when using the PCM Oscillator as an excitation for the string, the “pitch” of the PCM will affect the *timbre* of the string, and not the pitch of the overall sound.

On the other hand, when the string is used as a resonator or comb filter (by setting the string’s **Decay** and **Damping** to moderate values), the PCM Oscillator *will* control the overall pitch of the sound.

4-3a: Main

Octave [-2[32’], -1[16’], +0[8’], +1[4’]]

This sets the basic pitch of the PCM Oscillator, in octaves. The default is +0[8’].

Transpose [-12...+12]

This adjusts the pitch in semitones, over a range of ± 1 octave.

Tune [-1200...+1200]

This adjusts the pitch in cents, over a range of ± 1 octave. A cent is 1/100 of a semitone.

Frequency Offset [-10.0Hz ... +10.0Hz]

This adjusts the pitch by increments of 0.1 Hz. **Frequency Offset** is different from **Tune** in that, when used to detune the two oscillators, it can create a constant beat frequency across the range of the keyboard.

Pitch Slope [-1.00...+0.00...+2.00]

Normally, this should be set to the default of +1.00.

Positive (+) values cause the pitch to rise as you play higher on the keyboard, and **negative (-)** values cause the pitch to *fall* as you play higher on the keyboard.

When this is set to 0, playing different notes on the keyboard won’t change the pitch at all; it will be as if you’re always playing C4. This can be useful for special effects sounds, for instance.

If you want to create more complex effects, you can use one of the Key Track generators as a source for Pitch Modulation AMS.

JS+X [-60...+60 semitones]

This sets the maximum amount of pitch bend, in semitones, when you move the joystick to the right. For normal pitch bend, set this to a positive value.

JS-X [-60...+60 semitones]

This sets the maximum amount of pitch bend, in semitones, when you move the joystick to the left. For normal pitch bend, set this to a negative value.

4-3b: Portamento

Portamento lets the pitch glide smoothly between notes, instead of changing abruptly.

Portamento and MIDI

If Portamento is either enabled for both the String and the PCM, or off for both, then MIDI CCs 5 (Portamento Time) and 65 (Portamento on/off) affect both the String and the PCM.

If Portamento is enabled for only one of the two, only that element can be affected by the MIDI CCs. The other element will always have Portamento off, regardless of the MIDI CCs.

Enable [Off, On]

On (checked): Turns on Portamento, so that pitch glides smoothly between notes.

Off (unchecked): Turns off Portamento. This is the default state.

Fingered [Off, On]

This parameter allows you to control Portamento through your playing style. When it's enabled, playing legato will turn on Portamento, and playing detached will turn it off again.

This option is only available when Portamento Enable is turned on.

On (checked): Turns on Fingered Portamento.

Off (unchecked): Turns off Fingered Portamento.

Mode [Constant Rate, Constant Time]

Constant Rate means that Portamento will always take the same amount of time to glide a given distance in pitch - for instance, one second per octave. Put another way, gliding several octaves will take much longer than gliding a half-step.

Constant Time means that Portamento will always take the same amount of time to glide from one note to another, regardless of the difference in pitch. This is especially useful when playing chords, since it ensures that each note in the chord will end its glide at the same time.

Time [000...127]

This controls the portamento time. Higher values mean longer times, for slower changes in pitch. When **Time** is set to **0**, the pitch will be reached instantly—just as if Portamento **Enable** was turned **Off**.

AMS [List of AMS Sources]

This selects an AMS source to control the **Portamento Time**. For a list of AMS sources, see “Alternate Modulation Source (AMS) List” on page 903.

The modulation occurs only at note-on. This means that you can change the time for the *next* pitch glide, but you can't change any glides which are already in progress.

Intensity [-127...+127]

This controls the depth and direction of the **Portamento Time** AMS modulation.

4-3c: LFO

LFO Select [LFO 1, LFO 2, LFO 3, LFO 4, Common LFO]

This selects an LFO to modulate the PCM Oscillator's pitch.

The **LFO Intensity**, **JS+ Y Intensity**, and **AMS** are all summed together to produce the final amount of LFO pitch modulation.

LFO Intensity [-48.00...+48.00]

This controls the initial effect of the LFO on the pitch, in semitones, before any JS+Y or AMS modulation.

Negative (-) settings will invert the phase of the LFO.

Both the String and PCM Pitch LFO Intensities are scaled by MIDI CC#77.

JS+Y Intensity [-48.00...+48.00]

Moving the joystick “up” from the center detent position, away from yourself, produces the JS+Y controller. You can use this to scale the amount of the LFO applied to the pitch. This parameter sets the maximum amount of LFO modulation added by JS+Y, in semitones.

As this value is **increased**, moving the joystick in the +Y direction will cause the LFO to produce deeper pitch modulation.

Negative (-) settings will invert the phase of the LFO. You can also use this to reduce the initial amount of the LFO, as set by **LFO1 Intensity**, above.

AMS [AMS Sources]

This selects an AMS modulation source to scale the amount of the LFO applied to pitch.

For a list of AMS sources, see “Alternate Modulation Source (AMS) List” on page 903.

Intensity [-48.00...+48.00]

This controls the depth and direction of the LFO AMS modulation, in semitones.

4-3d: Pitch EG

EG Select [EG 1 (Filter), EG 2 (Pitch), EG 3, EG 4, Amp EG]

This selects an EG to modulate the PCM Oscillator pitch.

There are four assignable EGs, in addition to the Amp EG. Each of these can be used as a modulation source to control a wide variety of parameters.

In the midst of all this flexibility, we thought it would also be good to provide a little structure. With this in mind, EG 1 is named EG 1 (Filter) and EG 2 is labeled EG 2 (Pitch).

Please take these names as suggestions, rather than restrictions. If you like, you're free to use these EGs to control any EG or AMS destination, or to use other EGs to control Filter Frequency and Pitch.

Intensity [-48.00...+48.00]

This controls the initial effect of the Pitch EG on the PCM Oscillator, in half-steps, before any AMS modulation.

The Pitch EG's shape can swing all the way from +99 to -99. When the Intensity is set to a **positive (+)** value, positive values from the EG raise the pitch, and negative values lower the pitch.

When the Intensity is set to a **negative (-)** value, the effect of the EG is reversed; positive EG values mean *lower* pitches, and negative EG values mean *higher* pitches.

AMS **[AMS Sources]**

This selects an AMS modulation source to scale the amount of the Pitch EG applied to the PCM Oscillator.

For a list of AMS sources, see "Alternate Modulation Source (AMS) List" on page 903.

Intensity **[-48.00...+48.00]**

This controls the depth and direction of the pitch EG AMS modulation. The AMS modulation and the initial Intensity are added together to determine the Pitch EG's final effect.

4-3e: Pitch Modulation**AMS 1** **[List of AMS Sources]**

This selects the first modulation source for controlling the PCM Oscillator's pitch. For a list of AMS sources, see "Alternate Modulation Source (AMS) List" on page 903.

Intensity **[+/-48.00 semitones]**

This controls the depth and direction of the AMS 1 pitch modulation, in semitones.

Intensity Mod AMS **[List of AMS Sources]**

You can modulate AMS 1's Intensity from another AMS source. This selects that source.

Intensity **[+/-48.00 semitones]**

This controls the depth and direction of the Intensity Mod AMS, in semitones. The result is summed with the main AMS 1 Intensity to produce the final pitch modulation amount.

AMS 2 **[List of AMS Sources]**

This selects a second modulation source for controlling the PCM Oscillator's pitch. For a list of AMS sources, see "Alternate Modulation Source (AMS) List" on page 903.

Intensity **[+/-48.00 semitones]**

This controls the depth and direction of the AMS 2 pitch modulation, in semitones.

Intensity Mod AMS **[List of AMS Sources]**

You can modulate AMS 2's Intensity from another AMS source. This selects that source.

Intensity **[+/-48.00 semitones]**

This controls the depth and direction of the Intensity Mod AMS, in semitones. The result is summed with the main AMS 2 Intensity to produce the final pitch modulation amount.

✓ 4-3: Page Menu Commands

- Compare →p.112

- Write Program →p.112
- Exclusive Solo →p.113

- PAGE →p.126
- MODE →p.126

4-4: Excitation Mixer

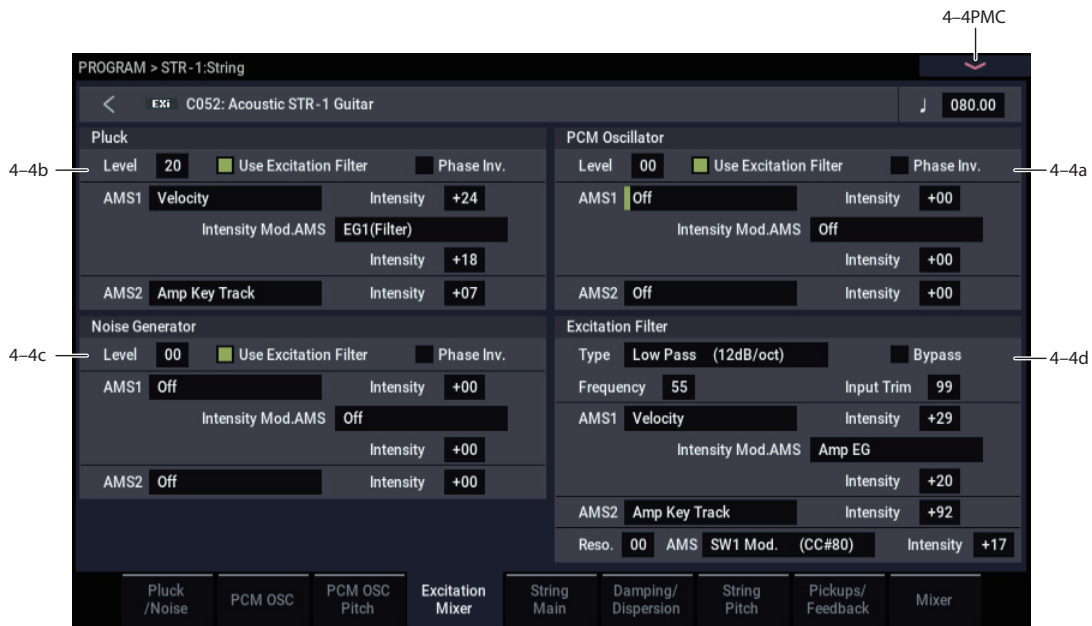

4-4a: PCM Oscillator

Level [00...99]

This controls the PCM Oscillator's input level to the String.

Phase Invert [Off, On]

This inverts the phase of the PCM Oscillator's input to the String. If you use two inputs, and one has an inverted phase, it's as if they were pushing the string in opposite directions.

Use excitation filter [Off, On]

This check-box sets whether or not the signal goes through the Excitation Filter, which controls the tone of the signal going into the string.

AMS 1 [List of AMS Sources]

This selects the first modulation source to control the **PCM Oscillator Level**. For a list of AMS sources, see "Alternate Modulation Source (AMS) List" on page 903.

Intensity [-99...+99]

This controls the depth and direction of the **PCM Oscillator Level AMS** modulation.

Intensity Mod AMS [List of AMS Sources]

This selects an AMS source to modulate the intensity of **AMS 1**.

Intensity [-99...+99]

This controls the depth and direction of the **Intensity Mod AMS**.

AMS 2 [AMS Sources]

This selects a second modulation source to control the **PCM Oscillator Level**. For a list of AMS sources, see "Alternate Modulation Source (AMS) List" on page 903.

Intensity [-99...+99]

This controls the depth and direction of **AMS 2**.

4-4b: Pluck

These parameters control the Pluck Table's input level to the String. They are identical to those for the PCM Oscillator; for more information, see "4-4a: PCM Oscillator" on page 219.

4-4c: Noise Generator

These parameters control the Noise Generator's input level to the String. They are identical to those for the PCM Oscillator; for more information, see "4-4a: PCM Oscillator" on page 219.

4-4d: Excitation Filter

This is a 2-pole, resonant multimode filter, for tailoring the excitation to the string.

Note: MIDI CCs 74 (Cutoff) and 71 (Resonance) do not affect this filter.

Filter Type [Low Pass, High Pass, Band Pass, Band Reject]

The filter will produce very different results depending on the selected filter type.

Low Pass. This cuts out the parts of the sound which are **higher** than the cutoff frequency. Low Pass is the most common type of filter, and is used to make bright timbres sound darker.

High Pass. This cuts out the parts of the sound which are **lower** than the cutoff frequency. You can use this to make timbres sound thinner or more buzzy.

Band Pass. This cuts out all parts of the sound, both highs and lows, except for the region around the cutoff frequency. Since this filter cuts out both high and low frequencies, its effect can change dramatically depending on the cutoff setting and the oscillator’s multisample.

With low resonance settings, you can use the Band Pass filter to create telephone or vintage phonograph sounds. With higher resonance settings, it can create buzzy or nasal timbres.

Band Reject. This filter type—also called a notch filter—cuts only the parts of the sound directly around the cutoff frequency. Try modulating the cutoff with an LFO to create phaser-like effects.

Filter Types and Cutoff Frequency

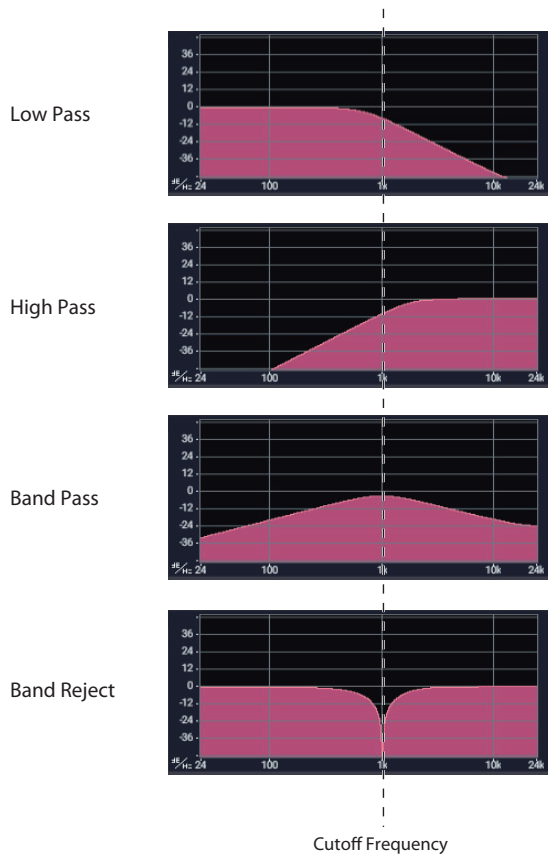

Bypass [Off, On]

This lets you bypass the filter completely.

If **Bypass** is **Off**, the filter functions normally.

When **Bypass** is **On**, the filter has no effect on the excitation signal.

Trim [00...99]

This adjusts the volume level at the input to the filter. If you notice that the sound is distorting, especially with high Resonance settings, you can turn the level down here.

Note that the filter will not clip internally.

Frequency [00...99]

This controls the cutoff frequency of Filter A, in increments of 1/10 of an octave. The specific effect of the cutoff frequency will change depending on the selected **Filter Type**, as described above.

AMS 1 [List of AMS Sources]

This selects the first modulation source for controlling the **Frequency**. For a list of AMS sources, see “Alternate Modulation Source (AMS) List” on page 903.

Intensity [-99...+99]

This controls the depth and direction of the AMS 1 **Frequency** modulation.

Intensity Mod AMS [List of AMS Sources]

You can modulate AMS 1’s Intensity from another AMS source. This selects that source.

Intensity [-99...+99]

This controls the depth and direction of the Intensity Mod AMS. The result is summed with the main AMS 1 Intensity to produce the final **Frequency** modulation amount.

AMS 2 [List of AMS Sources]

This selects a second modulation source for controlling the **Frequency**. For a list of AMS sources, see “Alternate Modulation Source (AMS) List” on page 903.

Intensity [-99...+99]

This controls the depth and direction of the AMS 2 **Frequency** modulation.

Resonance [00...99]

Resonance emphasizes the frequencies around the cutoff frequency.

When this is set to **0**, there is no emphasis, and frequencies beyond the cutoff will simply diminish smoothly.

At medium settings, the resonance will alter the timbre of the filter, making it sound more nasal, or more extreme.

At very high settings, the resonance can be heard as a separate, whistling pitch.

To make the resonance track the keyboard pitch, see “Key Follow,” on page 240.

AMS [AMS Sources]

This selects a modulation source to control the **Resonance** amount. For a list of AMS sources, see “Alternate Modulation Source (AMS) List” on page 903.

Intensity [-99...+99]

This controls the depth and direction of the **Resonance** modulation.

✓ 4-4: Page Menu Commands

- Compare →p.112
- Write Program →p.112
- Exclusive Solo →p.113
- PAGE →p.126
- MODE →p.126

4-5: String Main



4-5a: Excitation

The **Excitation** is the force that makes the string start to vibrate. For a physical string, this might be a guitar pick, a fingernail, a hammer on a clavinet, a plectrum on a harpsichord, and so on.

Position [0... 100.0]

This models the position of the excitation (such as the pluck) along the string, which has a strong effect on the timbre.

Important: the **Tone** parameter, below, must be non-zero in order for **Position** to have any effect.

0.0 is one end of the string, at the bridge; **100.0** is the other end of the string, at the nut (just before the headstock). Usually, values between 8.0 and 25.0 should work well.

50.0 is the middle of the string. The timbres of different values are approximately symmetric around this position, except for very near the ends of the string. In other words, 60.0 produces a similar timbre to 40.0, 75.0 is similar to 25.0, and so on. The delay between the excitation and the pickups will change, however.

Excitation Position

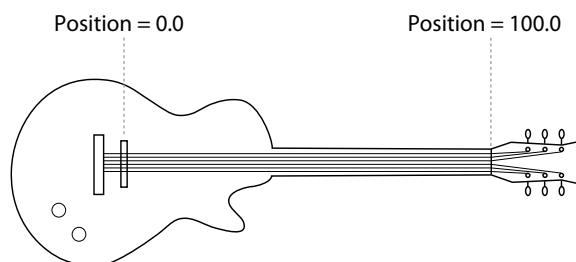

Harmonic structure with Position = 20.0 (ratio = 1/5)

How Position affects the timbre

Depending upon the **Position**, some overtones will be emphasized, and others de-emphasized. At specific positions, certain overtones will disappear completely, as detailed below.

You can also think of the **Position** as a fraction of the total string length. For instance, 50.0 means that the excitation is half-way along the string; 33.3 means that excitation is 1/3 of the way along the string; 25.0 is 1/4 of the way along the string, and so on.

Reaching back into math class for a moment, the number under the fraction is called the denominator. For instance, the denominator of 1/5 is 5.

As a rule of thumb, harmonics which are multiples of the denominator will be silent. For instance, if the **Position** is set to 20.0, the ratio is 1/5, and so every fifth harmonic will be silent: 5, 10, 15, etc. This is like a comb filter, with successive, evenly-spaced notches.

The graphic below shows the shape of this comb filter, and the resulting basic harmonic structure. (Comb filters are named because their shape looks a little like the teeth of a comb.)

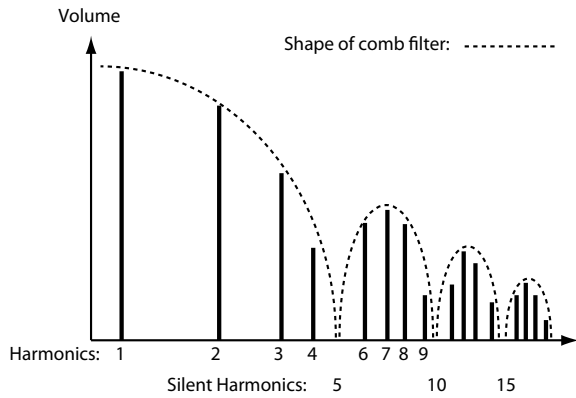

The table below shows a few more settings which cancel out specific harmonics:

Effect of Excitation Position on harmonic structure

| Position | Ratio of string length | Effect |
|----------|------------------------|--|
| 50.0 | 1/2 | Odd harmonics are silent, like a square-wave. |
| 33.3 | 1/3 | Every third harmonic is silent: 3, 6, 9 etc. |
| 25.0 | 1/4 | Every fourth harmonic is silent: 4, 8, 12 etc. |
| 20.0 | 1/5 | Every fifth harmonic is silent: 5, 10, 15 etc. |

You can also adjust the positions of the two Pickups, which produce similar comb filtering effects. (For more information, see “4–8a: Pickup 1” on page 230.) The filtering produced by the excitation position and the two pickups is cumulative, and can produce complex patterns of peaks and valleys in the overall frequency response.

AMS [List of AMS Sources]

This selects a modulation source to control the **Position**. Modulation is applied only at note-on; while the note is sounding, changing the modulation has no effect. For a list of AMS sources, see “Alternate Modulation Source (AMS) List” on page 903.

Intensity [-100.0...+100.0]

This controls the depth and direction of the **Position** modulation.

Tracking Mode [String Track, Keyboard]

This controls the relationship between the pickup **Position** and the pitch.

String Track scales the position according to the current String, as set in the String Track section.

Keyboard scales the position according to pitch, without taking the String settings into account. This might be more appropriate for clav sounds, for instance.

Tone [-100...+100]

This controls the affect of the **Position** on the overall tone. When **Tone** is set to 0, **Position** has no effect.

–100 is generally the most realistic, although other settings may give good results depending on the particular excitation signal. –100 also works well to counteract the low-end

“thump” which can be caused by low-frequency excitation signals, including plucks with very low (or negative) **Width** values.

Other **Tone** settings will make the comb filter described under **Position**, above, work differently. Settings between –100 and 0 will reduce the effect of the filter, until—at 0—it has no effect at all. Positive settings will make the filter work in reverse, reinforcing harmonics instead of eliminating them.

What does Tone do?

When you pluck a real string, the string vibrates outward in both directions from the excitation position. These two vibrations bounce off their respective ends of the string, return in the opposite direction, and interact with each other along the way, affecting the timbre of the string.

In the real world, this can’t be changed—but the Tone parameter lets you bend the physics a bit. This is useful, in part, because some of the things you can use to “pluck” the string—such as a PCM sample—aren’t things you could use in the real world, either. The Tone parameter gives you another tool adjust the way that these unusual excitations affect the timbre.

Put simply, Tone lets you pluck the same string twice, in the same place, with the waves from each pluck moving in only one direction. One of these plucks—think of it as the one that moves the wave “forward”—always works in the physical way. Tone controls the pluck that moves the wave “backwards.”

“Plucking” the string with different Tone settings

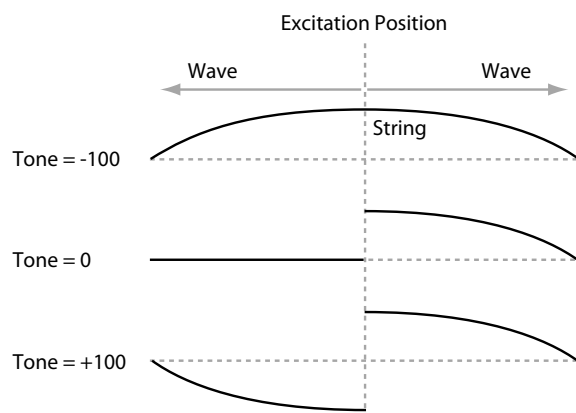

4–5b: Harmonic

This models pressing down lightly (or firmly) in the middle of the string, like playing harmonics on a guitar.

Use Excitation Position [Check-box]

This makes the harmonic use the same position as the excitation, including AMS modulation. Using this option creates an interesting hybrid pluck/chime timbre.

When this is checked, the rest of the Position parameters will be grayed out.

Position [0...100.0]

This controls the position at which the string is being pressed down. As when playing harmonics on a real string, the harmonic will be loudest when the position aligns with the harmonic series.

When the Harmonic **Tracking Mode** is set to **Keyboard**, it's easy to make the position match a specific harmonic, as shown below. When **Tracking Mode** is set to **String**, the values below are correct for the open-string notes only; on other notes, the harmonics will line up with slightly higher values.

Harmonic Position and the Harmonic Series, when Tracking Mode = Keyboard

| Position Value | Harmonic | Pitch |
|----------------|-------------|--------------------------|
| 100.0 | Fundamental | Unison |
| 50.0 | 1st | 1 octave up |
| 33.3 | 2nd | 1 octave + fifth |
| 25.0 | 3rd | 2 octaves up |
| 20.0 | 4th | 2 octaves + maj. third |
| 16.6 | 5th | 2 octaves + fifth |
| 14.2 | 6th | 2 octaves + flat seventh |
| 12.5 | 7th | 3 octaves up |

If **Use Excitation Position** is On, this parameter is grayed out.

AMS [List of AMS Sources]

This selects a modulation source to control the **Position**. For a list of AMS sources, see “Alternate Modulation Source (AMS) List” on page 903.

If **Use Excitation Position** is On, this parameter is grayed out.

Intensity [-100.0...+100.0]

This controls the depth and direction of the **Position** modulation.

If **Use Excitation Position** is On, this parameter is grayed out.

Tracking Mode [String Track, Keyboard]

This controls the relationship between the harmonic **Position** and the pitch.

String Track scales the position according to the current String, as set in the String Track section.

Keyboard scales the position according to pitch, without taking the String settings into account. This might be more appropriate for clav sounds, for instance.

If **Use Excitation Position** is On, this parameter is grayed out.

Pressure [0.0...100.0]

This controls how hard the string is being pressed down. Non-zero settings can create interesting special effects—but for standard use, this should be left at 0.0, and then modulated via AMS. For instance:

1. Follow the instructions under “Creating an initialized STR-1 Program” on page 214.
2. Assign EG3 to Harmonic AMS1, and set the Intensity to +100.0.
3. On the STR-1: EG– EG3 page, set the Break and Sustain levels to +00.
4. Adjust the Decay Time between 0 and 20, and listen to the way the sound changes.

This controls the amount of time that the string is being pressed down. As you increase this time, the harmonic tone will become more and more prominent. Around 18-20, the harmonic tone takes over completely. As you increase from 20 to 50, the tone becomes more pure, and less bright.

AMS 1 [List of AMS Sources]

This selects the first modulation source to control the **Pressure**. Often, it will make sense to use an envelope here. For a list of AMS sources, see “Alternate Modulation Source (AMS) List” on page 903.

Intensity [-100.0...+100.0]

This controls the depth and direction of the **Pressure** modulation.

Intensity Mod AMS [AMS Sources]

This selects a AMS modulation source to scale the intensity of **Pressure AMS 1**. For a list of AMS sources, see “Alternate Modulation Source (AMS) List” on page 903.

Intensity [-100.0...+100.0]

This controls the depth and direction of the **Intensity Mod AMS**. Even if the main AMS **Intensity** is set to 0, **Intensity Mod AMS** can still control the final amount of AMS over the full +/-100 range.

AMS 2 [List of AMS Sources]

This selects the second modulation source to control the **Pressure**. For a list of AMS sources, see “Alternate Modulation Source (AMS) List” on page 903.

Intensity [-100.0...+100.0]

This controls the depth and direction of the **Pressure** modulation.

Intensity Mod AMS [AMS Sources]

This selects a AMS modulation source to scale the intensity of **Pressure AMS 2**. For a list of AMS sources, see “Alternate Modulation Source (AMS) List” on page 903.

Intensity [-100.0...+100.0]

This controls the depth and direction of the **Intensity Mod AMS**. Even if the main AMS **Intensity** is set to 0, **Intensity Mod AMS** can still control the final amount of AMS over the full +/-100 range.

4–5c: Decay

Decay [0...100]

This controls the overall decay time of the string without affecting frequency content. This interacts with **Damping**, which controls the decay time for high frequencies. For more information, see “4–6a: Damping” on page 225.

Note: The **Amp EG** still controls the output level of the STR-1 as a whole, so the final decay time will be a combination of the **String Decay** and the **Amp EG**. As a general rule, the **Amp EG** can make the overall decay time shorter than the **String Decay**, but not longer.

For instance, if the **String Decay** is set to a high value (for a long decay), but the **Amp EG Decay** is short, the final result will be a short decay.

For more information, see “6–3: Amp EG” on page 245.

AMS 1 [List of AMS Sources]

This selects the first modulation source to control the **Decay**. For a list of AMS sources, see “Alternate Modulation Source (AMS) List” on page 903.

Intensity [-100...+100]

This controls the depth and direction of **AMS1**.

AMS 2 [List of AMS Sources]

This selects a second modulation source to control the **Decay**. For a list of AMS sources, see “Alternate Modulation Source (AMS) List” on page 903.

Intensity [-100...+100]

This controls the depth and direction of **AMS 2**.

Release [0...100]

This sets the overall release time for the string—the time that it takes to fade away after note-off.

Note: The **Amp EG** still controls the output level of the STR-1 as a whole, so the final release time will be a combination of the **String Release** and the **Amp EG**. For more information, see “Decay,” above.

AMS [List of AMS Sources]

This selects a modulation source to control the **Release**. For a list of AMS sources, see “Alternate Modulation Source (AMS) List” on page 903.

Intensity [-100...+100]

This controls the depth and direction of the **Release** modulation.

4–5d: Nonlinearity

Amount [-100.0...100.0]

This models the instability of the string’s bridge. Greater nonlinearity means a less rigid bridge. At higher levels, this causes the characteristic buzzing sound of some non-western stringed instruments, such as the sitar.

AMS1 [List of AMS Sources]

This selects the first modulation source to control the **Nonlinearity**. For a list of AMS sources, see “Alternate Modulation Source (AMS) List” on page 903.

Intensity [-100.0...+100.0]

This controls the depth and direction of the **Nonlinearity** modulation.

AMS2 [List of AMS Sources]

This selects a second modulation source to control the **Nonlinearity**. For a list of AMS sources, see “Alternate Modulation Source (AMS) List” on page 903.

Intensity [-100.0...+100.0]

This controls the depth and direction of the second **Nonlinearity** modulation.

✓ 4–5: Page Menu Commands

- Compare →p.112
- Write Program →p.112
- Exclusive Solo →p.113
- PAGE →p.126
- MODE →p.126

4-6: Damping/Dispersion

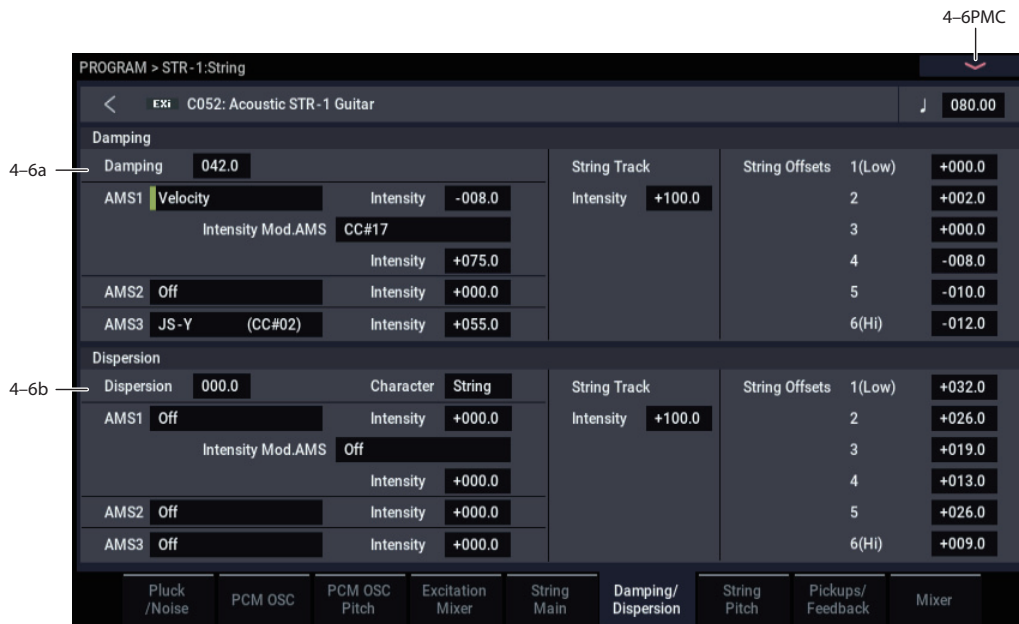

4-6a: Damping

Damping [0...100.0]

This controls the decay time for the string's high frequencies. Higher settings mean a shorter high frequency decay time, for a bright attack and a more mellow sustained tone. Lower settings let the string ring brightly for a longer period of time.

Damping interacts with the **Decay** parameter, which controls the overall decay time. For more information, see “4-5c: Decay” on page 224.

To create a comb-filtered effect with PCM or audio input, instead of a string model, set **Damping** to a moderate value.

AMS 1 [List of AMS Sources]

This selects the first modulation source to control the **Damping**. For a list of AMS sources, see “Alternate Modulation Source (AMS) List” on page 903.

Intensity [-100.0...+100.0]

This controls the depth and direction of the **Damping** AMS modulation.

Intensity Mod AMS [List of AMS Sources]

This selects an AMS source to modulate the intensity of **AMS 1**.

Intensity [-100.0...+100.0]

This controls the depth and direction of the **Intensity Mod AMS**.

AMS 2 [List of AMS Sources]

This selects a second modulation source to control the **Damping**. For a list of AMS sources, see “Alternate Modulation Source (AMS) List” on page 903.

Intensity [-100.0...+100.0]

This controls the depth and direction of **AMS 2**.

AMS 3 [List of AMS Sources]

This selects a third modulation source to control the **Damping**. For a list of AMS sources, see “Alternate Modulation Source (AMS) List” on page 903.

Intensity [-100.0...+100.0]

This controls the depth and direction of **AMS 3**.

String Track

String Track Intensity [-100.0...+100.0]

This controls the overall depth and direction of **String Tracking's** effect on the **Damping**. You can adjust the offsets for each string using the **Strings 1...6** parameters, as described below.

String 1...6 AMSource [-100.0...+100.0]

These set the individual **Damping** offsets for the six Strings, as set under “9-9b: Strings” on page 250. These values are also available for modulating other parameters via AMS; they appear in the AMS list as Damping String Track.

4-6b: Dispersion

Dispersion [0...100.0]

This models the rigidity of the string. Higher values correspond to thicker-gauge strings, and increase the inharmonicity of the string. (“Inharmonicity” means that the pitches of the overtones become out of tune with the fundamental.) At extreme values, it will create bell-like timbres, as if you were hitting a bar of metal.

Dispersion can be modulated by three AMS sources, which are added to the Dispersion setting.

Character**[Bell, String]**

This changes the way that the upper harmonics become detuned as **Dispersion** is increased.

With the **Bell** setting, as you increase the **Dispersion** amount, the lower harmonics will go out of tune gradually, but the upper harmonics will do so very steeply. The higher the harmonic, the more out-of-tune it will become. The resulting inharmonicity is similar to the sound of a bell.

With the **String** setting, the upper harmonics will still become more out of tune than the lower harmonics, but with a more gradual slope. Up to moderately high **Dispersion** settings, this retains a string-like character.

AMS 1**[List of AMS Sources]**

This selects the first modulation source to control the **Dispersion**. For a list of AMS sources, see “Alternate Modulation Source (AMS) List” on page 903.

Intensity**[-100.0...+100.0]**

This controls the depth and direction of the **Dispersion** AMS modulation.

Intensity Mod AMS**[List of AMS Sources]**

This selects an AMS source to modulate the intensity of **AMS 1**.

Intensity**[-100.0...+100.0]**

This controls the depth and direction of the **Intensity Mod** AMS.

AMS 2**[List of AMS Sources]**

This selects a second modulation source to control the **Dispersion**. For a list of AMS sources, see “Alternate Modulation Source (AMS) List” on page 903.

Intensity**[-100.0...+100.0]**

This controls the depth and direction of **AMS 2**.

AMS 3**[List of AMS Sources]**

This selects a third modulation source to control the **Dispersion**. For a list of AMS sources, see “Alternate Modulation Source (AMS) List” on page 903.

Intensity**[-100.0...+100.0]**

This controls the depth and direction of **AMS 3**.

String Track**String Track Intensity****[-100.0...+100.0]**

This controls the overall depth and direction of **String Track**'s effect on **Dispersion**. You can adjust the offsets for each individual string using the **String 1...6** parameters, as described below.

String 1...6 **AMSource****[-100...+100]**

These set the individual **Dispersion** offsets for the six Strings, as set under “9–9b: Strings” on page 250. For instance, you might set the lower strings to greater values, to model typical guitar strings.

These values are also available for modulating other parameters via AMS; they appear in the AMS list as **Disp. String Track**.

✓ 4–6: Page Menu Commands

- Compare →p.112
- Write Program →p.112
- Exclusive Solo →p.113
- PAGE →p.126
- MODE →p.126

4-7: String Pitch



4-7a: Main

Octave [-2[32'], -1[16'], +0[8'], +1[4'], +2[2']]

This sets the basic pitch of the String, in octaves. The default is +0[8'].

Transpose [-12...+12]

This adjusts the pitch in semitones, over a range of ± 1 octave.

Tune [-1200...+1200]

This adjusts the pitch in cents, over a range of ± 1 octave. A cent is 1/100 of a semitone.

Pitch Slope [-1.00...+0.00...+2.00]

Normally, this should be set to the default of +1.00.

Positive (+) values cause the pitch to rise as you play higher on the keyboard, and **negative (-)** values cause the pitch to *fall* as you play higher on the keyboard.

When this is set to **0**, playing different notes on the keyboard won't change the pitch at all; it will be as if you're always playing C4. This can be useful for special effects sounds, for instance.

If you want to create more complex effects, you can assign key tracking as an AMS source.

JS+ X [-60...+60 semitones]

This sets the maximum amount of pitch bend, in semitones, when you move the joystick to the right. For normal pitch bend, set this to a positive value.

JS- X [-60...+60 semitones]

This sets the maximum amount of pitch bend, in semitones, when you move the joystick to the left. For normal pitch bend, set this to a negative value.

4-7b: Portamento

Portamento lets the pitch glide smoothly between notes, instead of changing abruptly.

Portamento and MIDI

If Portamento is either enabled for both the String and the PCM, or off for both, then MIDI CCs 5 (Portamento Time) and 65 (Portamento on/off) affect both the String and the PCM.

If Portamento is enabled for only one of the two, only that element can be affected by the MIDI CCs. The other element will always have Portamento off, regardless of the MIDI CCs.

Enable [Off, On]

On (checked): Turns on Portamento, so that pitch glides smoothly between notes.

Off (unchecked): Turns off Portamento. This is the default state.

Fingered [Off, On]

This parameter allows you to control Portamento through your playing style. When it's enabled, playing legato will turn on Portamento, and playing detached will turn it off again.

This option is only available when Portamento Enable is turned on.

On (checked): Turns on Fingered Portamento.

Off (unchecked): Turns off Fingered Portamento.

Mode [Constant Rate, Constant Time]

Constant Rate means that Portamento will always take the same amount of time to glide a given distance in pitch - for instance, one second per octave. Put another way, gliding several octaves will take much longer than gliding a half-step.

Constant Time means that Portamento will always take the same amount of time to glide from one note to another, regardless of the difference in pitch. This is especially useful when playing chords, since it ensures that each note in the chord will end its glide at the same time.

Time [000...127]

This controls the portamento time. Higher values mean longer times, for slower changes in pitch. When **Time** is set to **0**, the pitch will be reached instantly—just as if Portamento **Enable** was turned **Off**.

AMS [List of AMS Sources]

This selects an AMS source to control the **Portamento Time**. For a list of AMS sources, see “Alternate Modulation Source (AMS) List” on page 903.

The modulation occurs only at note-on. This means that you can change the time for the *next* pitch glide, but you can’t change any glides which are already in progress.

Intensity [-127...+127]

This controls the depth and direction of the **Portamento Time** AMS modulation.

4–7c: LFO**LFO Select** [LFO 1, LFO 2, LFO 3, LFO 4, Common LFO]

This selects an LFO to modulate the String’s pitch.

The **LFO Intensity**, **JS+ Y Intensity**, and **AMS** are all summed together to produce the final amount of LFO pitch modulation.

LFO Intensity [-48.00...+48.00]

This controls the initial effect of the LFO on the pitch, in semitones, before any JS+Y or AMS modulation.

Negative (-) settings will invert the phase of the LFO.

Both the String and PCM Pitch LFO Intensities are scaled by MIDI CC#77.

JS+Y Intensity [-48.00...+48.00]

Moving the joystick “up” from the center detent position, away from yourself, produces the JS+Y controller. You can use this to scale the amount of the LFO applied to the pitch. This parameter sets the maximum amount of LFO modulation added by JS+Y, in semitones.

As this value is **increased**, moving the joystick in the +Y direction will cause the LFO to produce deeper pitch modulation.

Negative (-) settings will invert the phase of the LFO. You can also use this to reduce the initial amount of the LFO, as set by **LFO1 Intensity**, above.

AMS [AMS Sources]

This selects an AMS modulation source to scale the amount of the LFO applied to pitch.

For a list of AMS sources, see “Alternate Modulation Source (AMS) List” on page 903.

Intensity [-48.00...+48.00]

This controls the depth and direction of the LFO AMS modulation, in semitones.

4–7d: Pitch EG**EG Select** [EG 1 (Filter), EG 2 (Pitch), EG 3, EG 4, Amp EG]

This selects an EG to modulate the String pitch.

There are four assignable EGs, in addition to the Amp EG. Each of these can be used as a modulation source to control a wide variety of parameters.

In the midst of all this flexibility, we thought it would also be good to provide a little structure. With this in mind, EG 1 is named EG 1 (Filter) and EG 2 is labeled EG 2 (Pitch).

Please take these names as suggestions, rather than restrictions. If you like, you’re free to use these EGs to control any EG or AMS destination, or to use other EGs to control Filter Frequency and Pitch.

Intensity [-48.00...+48.00]

This controls the initial effect of the Pitch EG on the String, in half-steps, before any AMS modulation.

The Pitch EG’s shape can swing all the way from +99 to -99. When the Intensity is set to a **positive (+)** value, positive values from the EG raise the pitch, and negative values lower the pitch.

When the Intensity is set to a **negative (-)** value, the effect of the EG is reversed; positive EG values mean *lower* pitches, and negative EG values mean *higher* pitches.

AMS [AMS Sources]

This selects an AMS modulation source to scale the amount of the Pitch EG applied to the String.

For a list of AMS sources, see “Alternate Modulation Source (AMS) List” on page 903.

Intensity [-48.00...+48.00]

This controls the depth and direction of the pitch EG AMS modulation. The AMS modulation and the initial Intensity are added together to determine the Pitch EG’s final effect.

4–7e: Pitch Modulation**AMS 1** [List of AMS Sources]

This selects the first modulation source for controlling the String’s pitch. For a list of AMS sources, see “Alternate Modulation Source (AMS) List” on page 903.

Intensity [+/-48.00 semitones]

This controls the depth and direction of the AMS 1 pitch modulation, in semitones.

Intensity Mod AMS [List of AMS Sources]

You can modulate AMS 1’s Intensity from another AMS source. This selects that source.

Intensity [+/-48.00 semitones]

This controls the depth and direction of the Intensity Mod AMS, in semitones. The result is summed with the main AMS 1 Intensity to produce the final pitch modulation amount.

AMS 2 [List of AMS Sources]

This selects a second modulation source for controlling the String's pitch. For a list of AMS sources, see "Alternate Modulation Source (AMS) List" on page 903.

Intensity [+/-48.00 semitones]

This controls the depth and direction of the AMS 2 pitch modulation, in semitones.

Intensity Mod AMS [List of AMS Sources]

You can modulate AMS 2's Intensity from another AMS source. This selects that source.

Intensity [+/-48.00 semitones]

This controls the depth and direction of the Intensity Mod AMS, in semitones. The result is summed with the main AMS 2 Intensity to produce the final pitch modulation amount.

✓ 4-7: Page Menu Commands

- Compare →p.112
- Write Program →p.112
- Exclusive Solo →p.113

- PAGE →p.126
- MODE →p.126

4–8: Pickups/Feedback



4–8a: Pickup 1

Position [0...100.0]

This adjusts the location of the pickup along the string. You can modulate this via AMS, to create effects similar to chorusing. Unlike the **Excitation Position**, you can modulate the **Pickup Position** while the note is sounding. Typically, values between **8.0** and **25.0** will work well.

The effect of the **Pickup Position** is similar to that of the **Excitation Position**. The comb filtering produced by the excitation and the two pickups is cumulative, and can produce complex patterns of peaks and valleys in the frequency response.

The position is approximately symmetric around **50** for all of the notes when **Tracking Mode** is set to **Keyboard**; in other words, a value of **60** is roughly the same as **40**. When **Tracking Mode** is set to **String**, however, the point of symmetry varies for each note.

For more information, see “How Position affects the timbre” on page 221.

Harmonic and Pickup Positions

If the **Pickup Position** is same as the **Harmonic Position**, the pickup won’t produce much sound when **Harmonic Pressure** is applied.

Pickup Position and Note

The note being played defines another position along the string. For instance, with a guitar, the note is the position of the finger on the fretboard, as it presses down on the string. This creates a temporary end point for the string. At this end point, the string vibrates very little; beyond it, the string doesn’t vibrate at all.

Pickups don’t “hear” the entire string; they only hear the part of the string directly above them. If that part of the string isn’t vibrating (for instance, if it’s being held down!), there’s very little for a pickup to listen to—and thus the pickup won’t produce much sound, if it produces any at all.

For example, let’s say that you were listening only to **Pickup 1**.

Set the **Pickup Position** to **50** (the middle of the string), and the **Tracking Mode** to **String Track**. The open note of the top string, E4, will sound fine. As you play higher notes, however, the sound will become thinner, until it becomes very quiet at E5.

What happened here?

The pickup stays in same location, right in the middle of the string. With each semitone, the point at which the string is being pressed down moves up one fret. When you reach an octave up (at E5), the string is being pressed down in the middle of the string, right over the pickup.

If you play even higher, the pickup produces no sound since it is now outside the part of the string that is vibrating. (The STR-1 model assumes that your finger can hold down the string perfectly, so that no vibrations get past it.)

The higher the **Pickup Position**, the lower the range in which this can occur. The normal range of a guitar is much less than that of a 73- or 88-note keyboard, and higher pickup positions may make sense (and make sound!) only when playing within that normal guitar range.

Also, note that this can only happen when the **Tracking Mode** is set to **String Track**.

Pickup Position

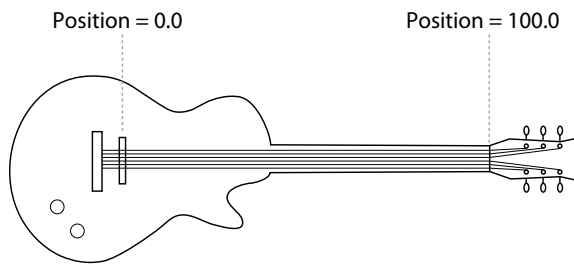

AMS [List of AMS Sources]

This selects a modulation source to control the **Position**. Try using an LFO, for instance. For a list of AMS sources, see “Alternate Modulation Source (AMS) List” on page 903.

Intensity [-100.0...+100.0]

This controls the depth and direction of the **Position** AMS modulation.

Tracking Mode [String Track, Keyboard, Off]

This controls the relationship between the pickup **Position** and the pitch.

String Track scales the pickup position according to the current String, as set in the String Tracking section.

Keyboard scales the pickup position according to pitch, without taking the String settings into account. This might be more appropriate for clav sounds, for instance.

Off disables pitch-related scaling. This setting works well when sweeping the position via AMS (such as by an LFO) for chorusing effects, as described below.

Creating “chorusing” with the pickups

For a chorus-like effect, set the pickup **Tracking Mode** to **Off**, and modulate the pickup position with an LFO. With the pickup **Tracking Mode** set to **Keyboard**, the modulation depth varies with note, so that the depth is large on the low end of the keyboard and small at the top. With the pickup **Tracking Mode** set to **String**, the depth will step to a new value at each open string.

4–8b: Pickup 2

This is the second pickup. It has the same parameters as Pickup 1, above.

4–8c: Feedback

This lets you route audio from elsewhere in NAUTILUS through the string. You can use any of the audio inputs, any of the audio outputs, the REC buses, the FX Control buses, or the outputs of any of the Insert, Master, or Total Effects.

The main purpose of this is to process the STR-1 through one or more Insert Effects, such as an overdrive or amp model, and then send that audio back into the STR-1, for traditional electric guitar feedback effects.

All three feedback parameters—**Distance**, **Orientation**, and **Level**—can be modulated in real-time. You can use this to model the classic effect of holding an electric guitar near an amp until it feeds back, and then varying the pitch of the feedback by changing the guitar’s orientation in relation to, and distance from, the amp.

You can also route live or recorded audio through the string an/or filters, in realtime—and we’re sure that you’ll be able to think of other creative uses!

Source and Channel

The feedback source and channel (left, right, or L+R summation) are selected by the Input Source and Channel parameters in the current Program, Combination Timbre, or Song Track.

For more information, see “4–2: EXi Audio Input” on page 134 (PROGRAM mode), “2–6: EXi Audio Input” on page 412 (COMBINATION mode), and “2–6: EXi Audio Input” on page 487 (SEQUENCER mode).

Distance (meters) [0.23...10.00]

This models the distance of the guitar from the amp. Usually, it’s best to set this very low, but higher settings may produce interesting effects.

AMS [List of AMS Sources]

This selects a modulation source to control the **Distance**. For a list of AMS sources, see “Alternate Modulation Source (AMS) List” on page 903.

Intensity [-10.00...+10.00]

This controls the depth and direction of the **Distance** AMS modulation.

Orientation (degrees) [-180...+180]

This models turning the guitar away from the amp. Turning the guitar primarily affects the tone of the feedback, but also affects the pitch and the volume.

AMS [List of AMS Sources]

This selects a modulation source to control the **Orientation**. For a list of AMS sources, see “Alternate Modulation Source (AMS) List” on page 903.

Intensity [-180...+180]

This controls the depth and direction of the **Orientation** AMS modulation.

Level [0...100]

This controls the overall gain of the feedback into the string. Unlike the other feedback parameters, this can be different for each voice.

AMS [List of AMS Sources]

This selects a modulation source to control the **Level**. For a list of AMS sources, see “Alternate Modulation Source (AMS) List” on page 903.

Intensity [-100...+100]

This controls the depth and direction of the **Level** AMS modulation.

✓ 4–8: Page Menu Commands

- Compare →p.112
- Write Program →p.112
- Exclusive Solo →p.113
- PAGE →p.126
- MODE →p.126

4-9: Mixer

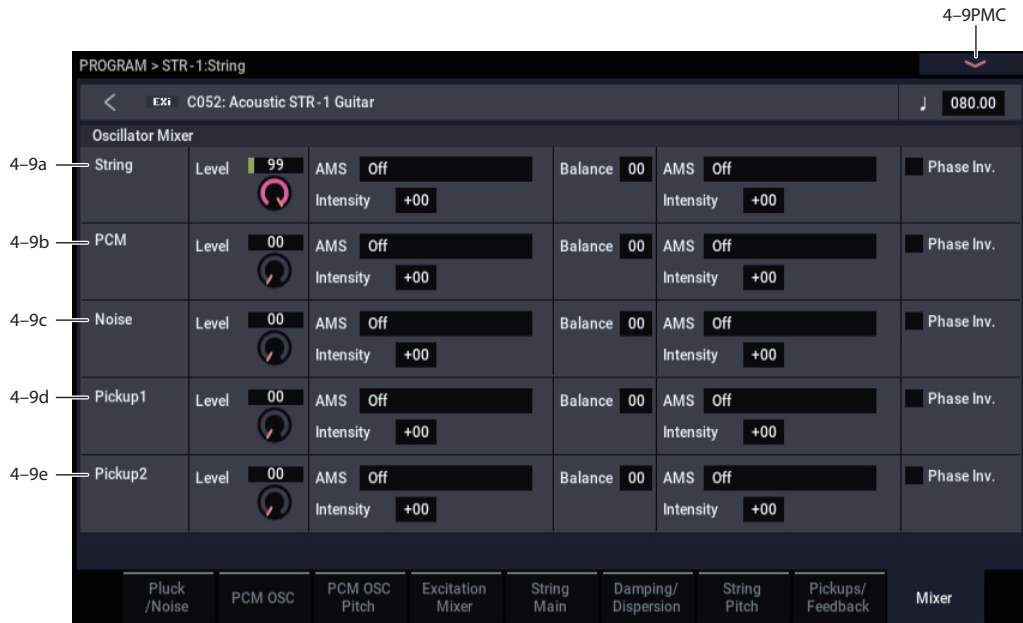

The Mixer page controls the volume levels and filter routing for the main String output, as well as the direct outputs (bypassing the string) of the PCM oscillator and Noise Generator. For instance, you can:

- Control the volume levels for the String, the PCM Oscillator, and the Noise Generator.
- Modulate these volume levels via AMS.
- When the **Filter Routing** is set to either **Serial** or **Parallel**, you can route each of the five elements through Filter A, Filter B, or a combination of the two—and then modulate that routing via AMS. For instance, you can create a layer by setting the **Filter Routing** to **Parallel**, and then sending the PCM Oscillator to Filter A, and the String to Filter B.

4-9a: String

Level [0...100]

This controls the volume level for the String.

AMS [List of AMS Sources]

This selects an AMS source to control the **String Level**. For a list of AMS sources, see “Alternate Modulation Source (AMS) List” on page 903.

Intensity [-100...+100]

This controls the depth and direction of the **String Level** AMS modulation.

Balance [0...100]

This controls the filter routing for the String. It applies only when the **Filter Routing** is set to either **Serial** or **Parallel**; otherwise, it is grayed out.

0 is the default, and means that the String goes into Filter A. If the **Filter Routing** is set to **Serial**, it will also pass through Filter B.

99 means that the String goes into Filter B.

In between, the String will go to a combination of both filters. By modulating the **Balance** via AMS, you can crossfade between routing through Filter A and Filter B. For more information, see “Interaction between the filters and the mixer,” on page 234.

AMS [List of AMS Sources]

This selects an AMS source to control the **String Balance**. For a list of AMS sources, see “Alternate Modulation Source (AMS) List” on page 903.

Intensity [-100...+100]

This controls the depth and direction of the **String Balance** AMS modulation.

Phase Invert [Off, On]

This inverts the phase of the String.

4-9b: PCM Oscillator

This controls the volume level and balance for the PCM Oscillator. It has the same parameters as described under “4-9a: String,” above.

4-9c: Noise

The Noise Generator has the same mixer parameters as described under “4-9a: String,” above.

4-9d: Pickup 1

Pickup 1 has the same mixer parameters as described under “4-9a: String,” above.

Try inverting the phase for one of the two pickups; this can produce an interesting effect.

4-9e: Pickup 2

Pickup 2 has the same mixer parameters as described under “4-9a: String,” above.

✓ 4-9: Page Menu Commands

- Compare →p.112
- Write Program →p.112
- Exclusive Solo →p.113

- PAGE →p.126
- MODE →p.126

PROGRAM > STR-1: Filter

5-1: Basic



Interaction between the filters and the mixer

When the **Filter Routing** is set to either **Single** or **24dB (4-Pole)**, the routing from the String section into the Filter section is fairly simple. There's only a single filter, and that filter processes the entire sound.

Things can get more interesting when the **Filter Routing** is set to **Serial** or **Parallel**. In these modes, The Mixer page's **Balance** parameters let you separately control the filter routing for each of the five inputs: the String, the PCM Oscillator, the Noise Generator, Pickup1, and Pickup2.

When an input's **Balance** is set to **0**, it goes into Filter A. (Note that if the **Filter Routing** is set to **Serial**, the signal will also pass through Filter B.)

If the input's **Balance** is set to **99**, it goes directly into Filter B, regardless of whether the routing is set to **Serial** or **Parallel**.

Standard serial configuration

To create a standard serial filter configuration:

1. Set the **Filter Routing** to **Serial**.

This connects the output of Filter A to the input of Filter B.

2. Set all of the mixer's **Balance** controls to **0**.

This makes all of the inputs go to Filter A first, and then through Filter B.

Standard parallel configuration

To create a standard parallel filter configuration:

1. Set the **Filter Routing** to **Parallel**.

2. Set all of the mixer's **Balance** controls to **50**.

This routes all of the inputs to both filters, at equal volumes.

Dual signal paths

You can also send the String through Filter A, and the PCM Oscillator through Filter B (or vice-versa), to create a layered sound. For instance:

1. Set the **Filter Routing** to **Parallel**.
2. Set the **String's Balance** to **0**.
3. Set the **PCM Oscillator's Balance** to **99**.

This routes the String to Filter A.

This routes the PCM Oscillator to Filter B.

Anywhere in-between

If an input's **Balance** is set between **1** and **98**, it will go to a combination of both filters—so that many “in between” filter effects are available.

Finally, by modulating an input's **Balance** via AMS, you can crossfade between routing through Filter A and Filter B.

5-1a: Routing

Filter Routing

[Single, Serial, Parallel, 24dB (4-Pole)]

There are two filters, Filter A and Filter B. This parameter controls whether one or both of the filters are used, and if both are used, it controls how they are connected to each other.

Single. This uses only Filter A as a single 2-pole, 12dB/octave filter (6dB for Band Pass and Band Reject). When this option is selected, the controls for Filter B will be grayed out.

Serial. This uses both filters. The output of Filter A is processed through Filter B.

Parallel. This also uses both Filter A and Filter B. Unlike Serial, above, the outputs of the two filters are kept separate, with individual control over both level and pan.

24dB (4-Pole). This merges both filters to create a single 4-pole, 24dB/octave filter (12dB for Band Pass and Band Reject). In comparison to Single, this option produces a sharper roll-off beyond the cutoff frequency, as well as a slightly more delicate resonance. Many classic analog synths used this general type of filter.

When **24dB (4-Pole)** is selected, only the controls for Filter A are active; the controls for Filter B will be grayed out. Also, note that the **Multi Filter** is not available in this mode.

5-1b: Filter A

Filter Type [Low Pass, High Pass, Band Pass, Band Reject, Multi Filter]

The filter will produce very different results depending on the selected filter type. The selections will change slightly according to the selected **Filter Routing**, to show the correct cutoff slope in dB per octave.

Low Pass. This cuts out the parts of the sound which are **higher** than the cutoff frequency. Low Pass is the most common type of filter, and is used to make bright timbres sound darker.

High Pass. This cuts out the parts of the sound which are **lower** than the cutoff frequency. You can use this to make timbres sound thinner or more buzzy.

Band Pass. This cuts out all parts of the sound, both highs and lows, except for the region around the cutoff frequency. Since this filter cuts out both high and low frequencies, its effect can change dramatically depending on the cutoff setting and the oscillator's multisample.

With low resonance settings, you can use the Band Pass filter to create telephone or vintage phonograph sounds. With higher resonance settings, it can create buzzy or nasal timbres.

Band Reject. This filter type—also called a notch filter—cuts only the parts of the sound directly around the cutoff frequency. Try modulating the cutoff with an LFO to create phaser-like effects.

Multi Filter. This is a complex filter which is capable of all of the above filter types, and many more besides. For more information, see “5-2: Multi Filter,” on page 237.

The Multi Filter is available only for Filter A, and only when the Filter Routing is set to **Single**, **Serial** or **Parallel**.

Filter Types and Cutoff Frequency

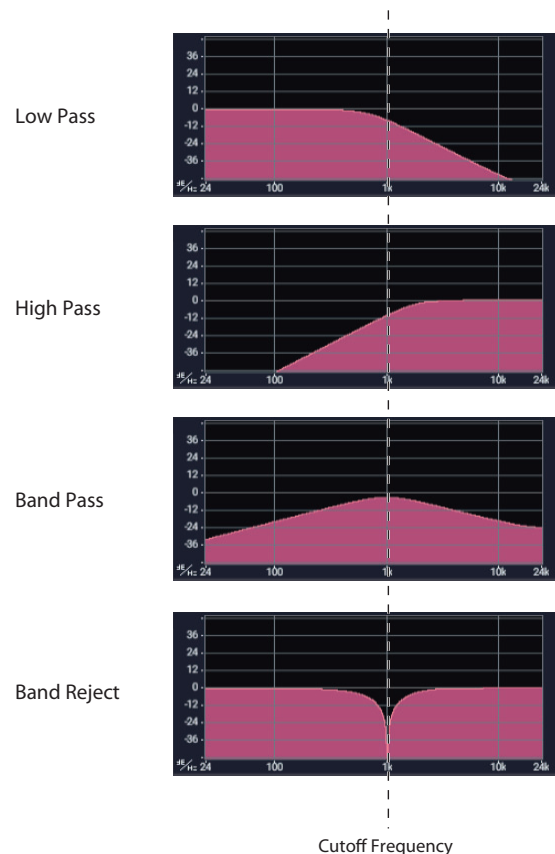

Bypass

[Off, On]

This lets you bypass Filter A completely.

If **Bypass** is **Off**, Filter A functions normally.

When **Bypass** is **On**, Filter A has no effect on the input signal.

Trim

[00...99]

This adjusts the volume level at the input to Filter A. If you notice that the sound is distorting, especially with high Resonance settings, you can turn the level down here, or at the Output Level.

Note that the filter will not clip internally, so there is no difference between adjusting the Input Trim and the Output Level. Either of these controls will allow you to minimize clipping later in the signal chain, such as may occur in some effects.

Output Level

[00...99]

This controls the output level of Filter A. You can use this to balance the volumes of Filters A and B when the Routing is set to Parallel, or to turn down the volume to avoid clipping later in the signal chain.

AMS

[AMS Sources]

This selects a modulation source to control the **Output Level**. For a list of AMS sources, see “Alternate Modulation Source (AMS) List” on page 903.

Intensity

[-99...+99]

This controls the depth and direction of the **Output Level** modulation.

Frequency [00...99]

This controls the cutoff frequency of Filter A, in increments of 1/10 of an octave. The specific effect of the cutoff frequency will change depending on the selected **Filter Type**, as described above.

Frequency Fine [-99...+99]

This provides fine control of the filter cutoff frequency. Each step of this parameter is equal to 1/100 of a step of the main **Frequency** parameter, above.

Resonance Type [Standard, High]

This controls the strength of the filter resonance when the **Filter Routing** is set to **24dB (4-Pole)**. When the routing is set to **Single**, **Serial**, or **Parallel**, this parameter is grayed out.

Standard provides the resonance character of a typical analog 4-pole filter.

High creates a more pronounced resonance.

Resonance Bass [Tight, Full]

This controls the character of the filter resonance at low cutoff frequencies. Its effect is most noticeable with high **Resonance** settings.

Tight produces a more restrained resonance, similar to a classic, American, wood-paneled monophonic synthesizer.

Full produces a wide, boomy resonance, reminiscent of a famous five-voice American synthesizer.

Resonance [00...99]

Resonance emphasizes the frequencies around the cutoff frequency.

When this is set to **0**, there is no emphasis, and frequencies beyond the cutoff will simply diminish smoothly.

At medium settings, the resonance will alter the timbre of the filter, making it sound more nasal, or more extreme.

At very high settings, the resonance can be heard as a separate, whistling pitch.

To make the resonance track the keyboard pitch, see “Key Follow,” on page 240.

Resonance Mod by AMS [AMS Sources]

This selects a modulation source to control the Resonance amount. For a list of AMS sources, see “Alternate Modulation Source (AMS) List” on page 903.

Intensity [-99...+99]

This controls the depth and direction of the **Resonance** modulation.

Pan [Random, L001...C064...R127]

This controls the stereo pan for Filter A’s output. It is available only when **Filter Routing** is set to **Parallel**.

When the **Filter Routing** is set to **Single**, **Serial**, or **24dB (4-Pole)**, the Pan parameters will be grayed out.

AMS [AMS Sources]

This selects an AMS source to modulate **Pan**. For a list of AMS sources, see “Alternate Modulation Source (AMS) List” on page 903.

Intensity [-99...+99]

This controls the depth and direction of the **Pan** AMS modulation.

5-1c: Filter B

Filter B is available when the **Filter Routing** is set to **Serial** or **Parallel**. Otherwise, its parameters will be grayed out.

Filter B is almost the same as Filter A, but without the **Multi Filter** mode, and with the addition of the **Link** controls, as described below. For all other parameters, please see the descriptions under “5-1b: Filter A,” on page 235.

Link [Off, On]

When **Link** is **On**, most of Filter B’s parameters are grayed out, and are instead controlled by the settings for Filter A.

Specifically, Filter B will use Filter A’s settings for **Resonance**, **Resonance Bass**, and all Frequency and Resonance modulation settings. Filter B’s **Frequency** is also linked to that of Filter A, with an optional frequency offset via the **Link Frequency Offset** parameter, below.

The **Bypass**, **Type**, **Input Trim**, **Output Level**, **Output Level AMS**, **Pan**, and **Pan AMS** parameters are still controlled separately.

Link Frequency Offset [-99...+99]

This offsets Filter B’s Frequency from that of Filter A, and applies only when **Link** is **On**.

When **Link** is **Off**, this parameter is grayed out.

✓ 5-1: Page Menu Commands

- Compare →p.112
- Write Program →p.112
- Exclusive Solo →p.113
- PAGE →p.126
- MODE →p.126

5-2: Multi Filter



This page is available only when the **Filter A Type** is set to **Multi Filter**.

What's a Multi Filter?

Standard multimode filters generate lowpass, highpass, and bandpass filters simultaneously - but only allow you to use one of them at a time.

The Multi Filter gives you access to all three filter modes simultaneously, in any combination, along with the dry input signal. You can choose from a large number of preset combinations, or create your own complex filter modes using the Manual controls.

This is capable of some cool sounds in and of itself, but things really get interesting when you use the Crossfade controls. These allow you to crossfade between two of these filter settings (Mode 1 and Mode 2), using AMS sources such as EGs, LFOs, or real-time controllers.

5-2a: Filter A

| | |
|------------------|--------------------|
| Bypass | [Off, On] |
| Frequency | [00...99] |
| Fine | [-99...+99] |
| Resonance | [00...99] |

These are the same as the similarly-named parameters on the Filter Basic page, as described under “5-1b: Filter A” on page 235.

Edits to the values on this page will be reflected on the Filter Basic page, and vice-versa.

5-2b: Mode Crossfade

Mode 1

[List of filter types]

This sets the filter type for Mode 1.

Low Pass, High Pass, Band Pass, and Band Reject are the standard filter types. For more information, see “Filter Type,” on page 235.

The following types combine two or more filters at equal volumes. **Dry** is the un-filtered input signal. The minus sign (“-”) indicates when the phase of a filter is reversed: **LP+BP, LP-BP, LP-HP, BP+HP, BP-HP, Dry+LP, Dry-LP, Dry+BP, Dry-BP, Dry+LP-HP, Dry+LP-BP, Dry+BP-LP, Dry+BP-HP, Dry+HP-LP, Dry+HP-BP, LP+HP+BP.**

All On uses the Low Pass, High Pass, Band Pass, and Dry signals at equal volumes.

Manual 1 lets you create your own mix of the filters. For more information, see “5-2c: Manual 1,” below.

Mode 2

[List of filter types]

Mode 2 has the same selections as Mode 1, except that the list ends with Manual 2 instead of Manual 1.

Mode 1-2 Crossfade

[0...99]

This fades between the Mode 1 and Mode 2 settings.

0 is all **Mode 1**, **99** is all **Mode 2**, and **1-98** are intermediate values between the two Modes.

AMS

[AMS Sources]

This selects a modulation source to control the **Mode 1-2 Crossfade**. For a list of AMS sources, see “Alternate Modulation Source (AMS) List” on page 903.

Intensity

[-99...+99]

This controls the depth and direction of the **Mode 1-2 Crossfade** modulation.

Intensity Mod AMS [List of AMS Sources]

This selects an AMS source to modulate the intensity of the main **Mode 1-2 Crossfade AMS**.

For instance, you can set **AMS** to use one of the LFOs, and then set the **Intensity Mod AMS** to JS -Y. You can then use the joystick to modulate the amount of the LFO.

Intensity [-99...+99]

This controls the depth and direction of the **Intensity Mod AMS**.

5-2c: Manual 1

These parameters let you create your own mix of the filters. When **Mode 1** is set to **Manual 1**, it will use these settings.

You may wonder why Band Reject is not included here. This is because it's not a filter mode per se. Instead, it's created by an equal combination of High Pass and Low Pass. Try it and see!

Lowpass [-99...+99]

This controls the volume of the Lowpass filter output. Negative values invert the phase.

Highpass [-99...+99]

This sets the volume of the Highpass filter output.

Bandpass [-99...+99]

This controls the volume of the Bandpass filter output.

Dry [-99...+99]

This sets the volume of the dry signal.

5-2d: Manual 2

The Manual 2 parameters are identical to those of Manual 1, as described above.

✓ 5-2: Page Menu Commands

- Compare →p.112
- Write Program →p.112
- Exclusive Solo →p.113
- PAGE →p.126
- MODE →p.126

5-3: Filter Mod.



This page contains all of the settings for **Filter Frequency** modulation (except for the LFOs, which are on their own page). Among other things, you can:

- Set up complex keyboard tracking shapes, and control how the tracking affects filter cutoff.
- Control the effect of the Filter Envelope on filter cutoff.
- Assign AMS modulation for filter cutoff.

Filter B is available when the **Filter Routing** is set to **Serial** or **Parallel**. Otherwise, the parameters for Filter B will be grayed out.

5-3a: Keyboard Track AMSource

Most acoustic instruments get brighter as you play higher pitches. At its most basic, keyboard tracking re-creates this effect by increasing the cutoff frequency of a lowpass filter as you play higher on the keyboard. Usually, some amount of key tracking is necessary in order to make the timbre consistent across the entire range.

The NAUTILUS keyboard tracking can also be much more complex, since it allows you to create different rates of change over up to four different parts of the keyboard.

The STR-1's Filter keyboard tracking parameters are identical to the HD-1's. For more detailed explanations of the parameters, please see "3-2a: Keyboard Track," on page 65.

There is one difference between the two, however: the STR-1's Filter tracking is affected by Portamento, so that it changes smoothly during glides.

Intensity to A [-99...+99]

This controls how much the keyboard tracking will affect Filter A's cutoff frequency. The overall effect of the Keyboard Track is a combination of this **Intensity** value and the overall Keyboard Track shape.

Intensity to B [-99...+99]

This controls how much the keyboard tracking will affect Filter B's cutoff frequency.

Intensity to B applies only when the **Filter Routing** is set to **Serial** or **Parallel**, and when **Link** is **Off**. In **Single** and **24dB (4-Pole)** modes, or if **Link** is **On**, this parameter is grayed out.

Key

Low Break [C-1...G9]

This sets the breakpoint note between the two lower ramps.

Center [C-1...G9]

This sets the center of the keyboard tracking. At this key, the keyboard tracking has no effect on the filter frequency, or on any AMS destinations.

High Break [C-1...G9]

This sets the breakpoint note between the two higher ramps.

Ramp

The effect on the filter cutoff is a combination of the ramp values, as set below, and the Intensity to A and B parameters. When Intensity is set to +99, a ramp of 50 changes the filter frequency by 1 octave for every octave of the keyboard, and a ramp of +99 changes the frequency by 2 octaves for every octave of the keyboard.

+Inf and -Inf are special settings which create abrupt changes for split-like effects. When a ramp is set to +Inf or -Inf, the keyboard tracking will go to its extreme highest or lowest value over the span of a single key.

For more detailed explanations, please see "3-2a: Keyboard Track," on page 65

Bottom-Low [-Inf, -99...+99, +Inf]

This sets the slope between the bottom of the MIDI note range and the Low Break key. For normal key track, use negative values.

Low-Center [-Inf, -99...+99, +Inf]

This sets the slope between the Low Break and Center keys. For normal key track, use negative values.

Center-High [-Inf, -99...+99, +Inf]

This sets the slope between the Center and High Break keys. For normal key track, use positive values.

High-Top [-Inf, -99...+99, +Inf]

This sets the slope between the High Break key and the top of the MIDI note range. For normal key track, use positive values.

Key Follow

To create the classic Key Follow effect, in which the filter frequency tracks the pitch of the keyboard:

1. Set the Filter Frequency to 30.
2. Set the Keyboard Track Intensity to +99.
3. Set the Bottom-Low and Low-Center ramps to -50.
4. Set the Center-High and High-Top ramps to +50.
5. Set the Center Key to C4.

The settings for the Low Break and High Break keys don't matter in this case.

5-3b: Filter EG

The EGs modulate the Filter A and B cutoff frequencies over time. You can control how strongly they will affect the filters in three different ways:

- Set an initial amount of EG modulation, using the EG Intensity parameters.
- Use velocity to scale the amount of the EG applied to the filter.
- Use any AMS source to scale the amount of the EG applied to the filter.

You can use all three of these at once, and the results are added together to produce the total EG effect.

To set up the EGs themselves, including attack and release times, levels, and so on, see “7-1: EG 1 (Filter),” on page 248.

Filter A**EG Select** [EG 1 (Filter), EG 2 (Pitch), EG 3, EG 4, Amp EG]

This selects an EG to modulate Filter A's Frequency.

There are four assignable EGs, in addition to the Amp EG. Each of these can be used as a modulation source to control a wide variety of parameters.

In the midst of all this flexibility, we thought it would also be good to provide a little structure. With this in mind, EG 1 is named EG 1 (Filter) and EG 2 is labeled EG 2 (Pitch).

Please take these names as suggestions, rather than restrictions. If you like, you're free to use these EGs to control any EG or AMS destination, or to use other EGs to control Filter Frequency and Pitch.

Velocity Intensity [-99...+99]

This lets you use velocity to scale the amount of the EG applied to Filter A.

EG Intensity [-99...+99]

This controls the initial effect of the EG on Filter A's cutoff frequency, before any velocity or AMS modulation.

AMS [AMS Sources]

This selects an AMS modulation source to scale the amount of the EG applied to Filter A.

For a list of AMS sources, see “Alternate Modulation Source (AMS) List” on page 903.

Intensity [-99...+99]

This controls the depth and direction of the AMS modulation.

Filter B

The EG parameters for Filter B are the same as those for “Filter A,” above.

When **Link** is **On**, or when the Filter Routing is set to **Single** or **24dB (4-Pole)**, all of these parameters are grayed out.

5-3c: Filter Modulation**Filter A Frequency****AMS 1** [AMS Sources]

This selects the first modulation source to control Filter A's **Frequency**. For a list of AMS sources, see “Alternate Modulation Source (AMS) List” on page 903.

Intensity [-99...+99]

This controls the depth and direction of the **Frequency** modulation.

Intensity Mod AMS [List of AMS Sources]

This selects an AMS source to modulate the intensity of **AMS 1**.

Intensity [-99...+99]

This controls the depth and direction of the **Intensity Mod AMS**.

AMS 2 [AMS Sources]

This selects a second modulation source to control Filter A's **Frequency**. For a list of AMS sources, see “Alternate Modulation Source (AMS) List” on page 903.

Intensity [-99...+99]

This controls the depth and direction of **AMS 2**.

Filter B Frequency

The settings for Filter B are the same as those for “Filter A Frequency,” above.

When **Link** is **On**, or when the Filter Routing is set to **Single** or **24dB (4-Pole)**, all of these parameters are grayed out.

✓ 5-3: Page Menu Commands

- Compare →p.112
- Write Program →p.112
- Exclusive Solo →p.113
- PAGE →p.126
- MODE →p.126

5-4: Filter LFO Mod.

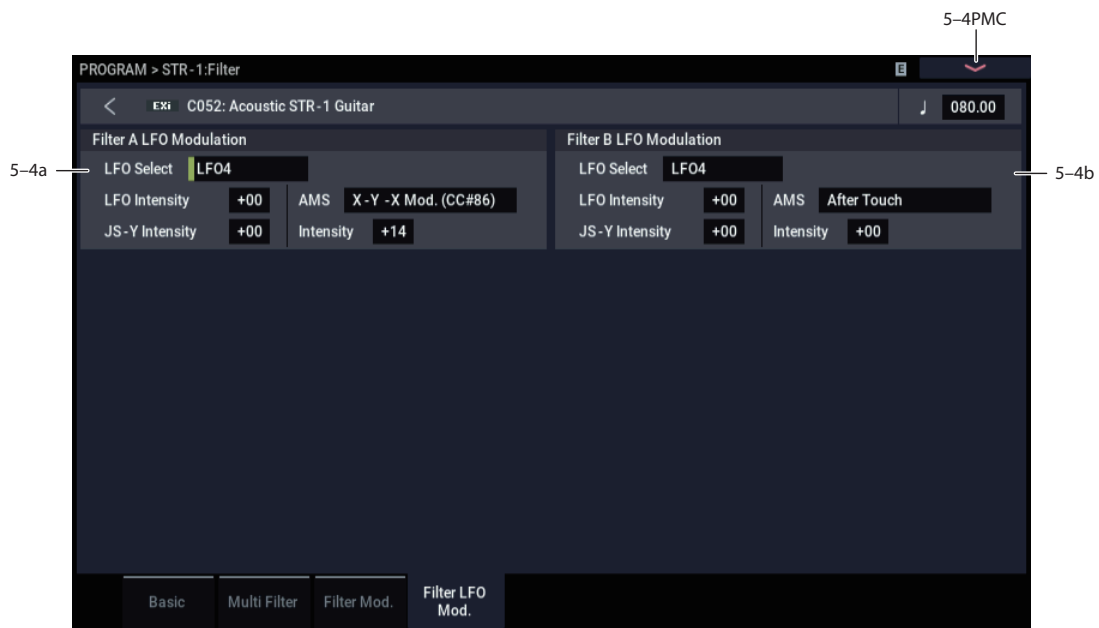

There are three LFO-to-Frequency controls for each filter: a basic amount (**LFO Intensity**), joystick -Y control of LFO amount (**JS- Y Intensity**), and AMS control of LFO amount (**AMS Intensity**). The three controls are summed together to determine the final LFO amount.

5-4a: Filter A

LFO Select [LFO 1, LFO 2, LFO 3, LFO 4, Common LFO]

This selects an LFO to modulate Filter A’s cutoff frequency.

The **LFO Intensity**, **JS -Y Intensity**, and **AMS** are all summed together to produce the final amount of LFO pitch modulation.

LFO Intensity [-99...+99]

This controls the initial effect of the LFO on Filter A’s cutoff frequency, before any JS+Y or AMS modulation.

Negative (-) settings will invert the phase of the LFO.

JS -Y Intensity [-99...+99]

Moving the joystick “down” from the center detent position, towards yourself, produces the JS -Y controller. You can use this to scale the amount of the LFO applied to Filter A.

This parameter sets the maximum amount of LFO modulation added by JS -Y.

AMS

[AMS Sources]

This selects an AMS modulation source to scale the amount of the LFO applied to Filter A’s cutoff frequency.

For a list of AMS sources, see “Alternate Modulation Source (AMS) List” on page 903.

Intensity

[-99...+99]

This controls the depth and direction of the LFO AMS modulation.

5-4b: Filter B

The settings for Filter B are the same as those for “5-4a: Filter A,” above.

When **Link** is **On**, or when the Filter Routing is set to **Single** or **24dB (4-Pole)**, all of these parameters are grayed out.

✓ 5-4: Page Menu Commands

- Compare →p.112
- Write Program →p.112
- Exclusive Solo →p.113
- PAGE →p.126
- MODE →p.126

PROGRAM > STR-1: Amp

These pages let you control the sound's volume (also called "amplitude," or "amp" for short), pan, and the dedicated amp envelopes and keyboard tracking generators. For instance, you can:

- Set the pan position and pan modulation.
- Control amp level and modulation, including keyboard tracking, the amp envelope, LFO modulation, and AMS control.

6-1: Amp

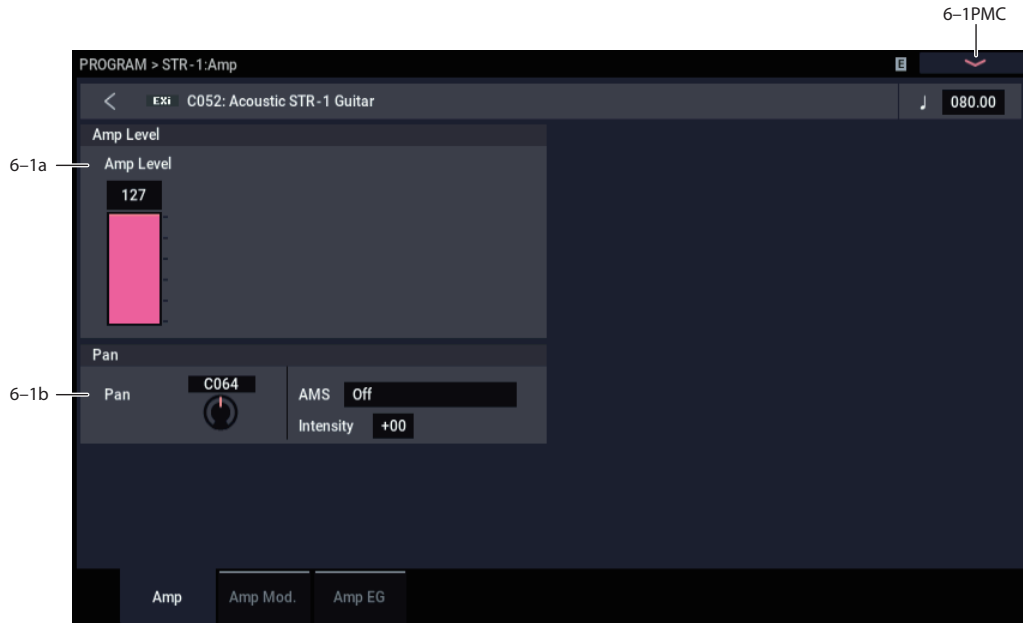

This page controls the basic settings for the Amp section. Here, you can:

- Set the initial volume level.
- Control the pan position and pan modulation.

6-1a: Amp Level

Amp Level [0...127]

This controls the basic volume level of the STR-1, before keyboard tracking, velocity, and other modulation.

MIDI and volume

MIDI You can control the Program's overall volume via MIDI using both Volume (CC#7) and Expression (CC#11). When used one at a time, the two controllers work in exactly the same way: a MIDI value of 127 is equal to the Amp Level setting, and lower values reduce the volume.

If both CC#7 and CC#11 are used simultaneously, the one with the *lower* value determines the maximum volume, and the one with the higher value scales down from that maximum.

This is controlled on the global MIDI channel (GLOBAL 1-1a).

6-1b: Pan

Pan [Random, L001...C064...R127]

This controls the stereo pan of the EXi. A setting of **L001** places the sound at the far left, **C064** in the center, and **R127** to the far right.

When **Filter Routing** is set to **Parallel**, the two filters can be panned separately (see "Pan" on page 236) and the STR-1 can create a stereo output. In this case, **Pan** steers the stereo image while maintaining the relative volumes of the STR-1's left and right outputs. For instance, as you move **Pan** to the right of center, the STR-1's left output will start to move to the right side, until at **R127** both the left and right outputs sound entirely in the right channel.

When this is set to **Random**, the pan position will be different for each note-on.

MIDI You can also control pan via MIDI Pan (CC#10). A CC#10 value of 0 or 1 places the sound at the far left, 64 places the sound at the location specified by the "Pan" parameter, and 127 places the sound at the far right.

Note: You can select Random pan only from the on-screen UI, and not from MIDI. This is controlled on the global MIDI channel (GLOBAL 1-1a).

AMS [AMS Sources]

This selects an AMS source to modulate **Pan**. For a list of AMS sources, see "Alternate Modulation Source (AMS) List" on page 903.

Intensity [-99...+99]

This controls the depth and direction of the AMS modulation for **Pan**.

For example, if **Pan** is set to C064 and **AMS** is set to Note Number, **positive (+)** intensities will cause the sound to move toward the right as you play higher than C4, and toward the left as you play lower than C4.

Negative (-) intensities will have the opposite effect.

✓ **6-1: Page Menu Commands**

- Compare →p.112
- Write Program →p.112
- Exclusive Solo →p.113
- PAGE →p.126
- MODE →p.126

6-2: Amp Mod.

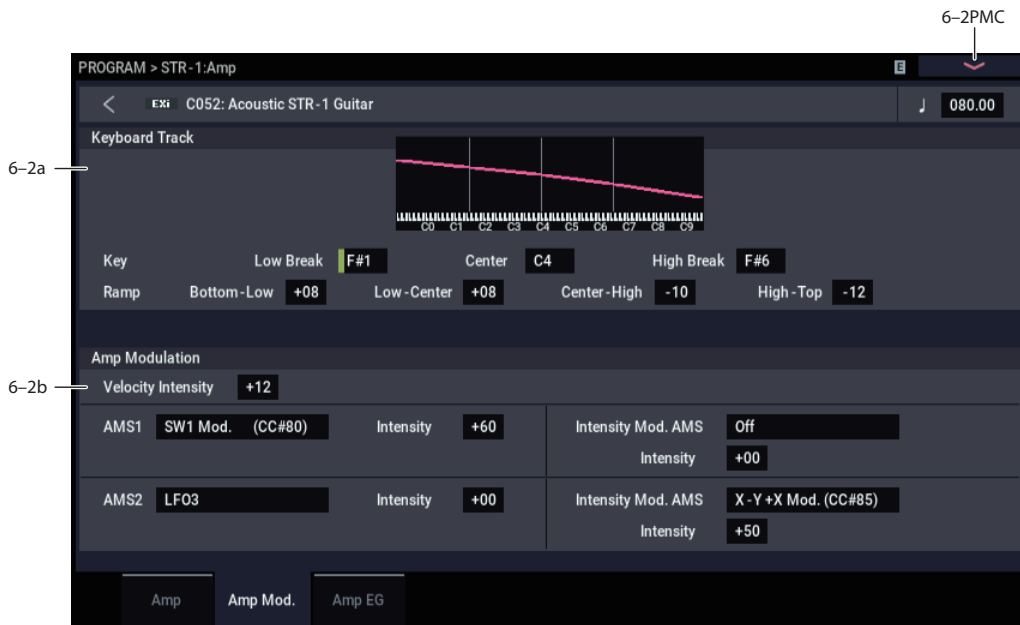

This page contains the settings for the STR-1’s Amp level modulation. Among other things, you can:

- Set up complex keyboard tracking shapes to control the Amp level.
- Assign AMS modulation for the Amp level.
- Control the effect of the LFOs on the Amp level.

The total effects of the modulation can increase the volume to a maximum of two times louder than the Amp Level setting.

6-2a: Keyboard Track AMSsource

Keyboard tracking lets you vary the volume as you play up and down the keyboard. Usually, some amount of key tracking is necessary in order to make the volume consistent across the entire range.

The STR-1’s Amp keyboard tracking parameters are identical to the HD-1’s. For more detailed explanations of the parameters, please see “4-2a: Keyboard Track,” on page 76.

There is one difference between the two, however: the STR-1’s Amp tracking is affected by Portamento, so that it changes smoothly during glides.

Key

Low Break [C-1...G9]

This sets the breakpoint note between the two lower ramps.

Low-Center [-Inf, -99...+99, +Inf]

This sets the slope between the Low Break and Center keys.

Center [C-1...G9]

This sets the center of the keyboard tracking. At this key, the keyboard tracking has no effect on the volume, or on any AMS destinations.

High Break [C-1...G9]

This sets the breakpoint note between the two higher ramps.

Ramp

Bottom-Low [-Inf, -99...+99, +Inf]

This sets the slope between the bottom of the MIDI note range and the Low Break key. For normal key track, use negative values.

| Ramp | Change in level |
|------|--------------------------|
| -Inf | Silent in one half-step |
| -99 | Silent in one whole-step |
| -95 | Silent in one octave |
| -48 | Silent in two octaves |
| -25 | Silent in four octaves |
| 00 | no change |
| +25 | x2 in four octaves |
| +50 | x2 in two octaves |
| +99 | x2 in one octave |
| +Inf | x2 in one half-step |

For normal key track, use negative values.

Center-High [-Inf, -99...+99, +Inf]

This sets the slope between the Center and High Break keys. For normal key track, use positive values.

High-Top [-Inf, -99...+99, +Inf]

This sets the slope between the High Break key and the top of the MIDI note range. For normal key track, use positive values.

6-2b: Amp Modulation

You can modulate the Amp level by velocity and two AMS sources. Each of the AMS sources also has its own secondary intensity modulation.

This modulation scales the basic Amp level and Amp EG level parameters. If these original levels are low, the maximum volume available with modulation will also be reduced.

Note that there is an upper limit to Amp modulation. Once the volume level reaches double the programmed Amp Level and Amp EG level settings, it cannot be increased any further.

Velocity Intensity [-99...+99]

With **positive (+)** values, the volume will increase as you play harder.

With **negative (-)** values, the volume will decrease as you play harder.

AMS1 [AMS Sources]

This selects the first modulation source for the Amp level. For a list of AMS sources, see “Alternate Modulation Source (AMS) List” on page 903.

Intensity [-99...+99]

This sets the initial amount of AMS1. The **Intensity Mod AMS** then adds to this initial amount.

Intensity Mod AMS [AMS Sources]

This selects a secondary AMS modulation source to scale the intensity of AMS1.

For a list of AMS sources, see “Alternate Modulation Source (AMS) List” on page 903.

Intensity [-99...+99]

This controls the depth and direction of the **Intensity Mod AMS**. Even if the main AMS1 Intensity is set to 0, Intensity Mod AMS can still control the final amount of AMS A over the full +/-99 range.

For example, if AMS1 is set to LFO1, and Intensity Mod AMS is set to JS+Y, positive settings mean that pushing the joystick away from yourself will increase the intensity of the LFO modulation of Amp.

AMS2 [AMS Sources]

This selects a second modulation source for the Amp level. For a list of AMS sources, see “Alternate Modulation Source (AMS) List” on page 903.

Intensity [-99...+99]

This sets the initial amount of AMS2. The **Intensity Mod AMS** then adds to this initial amount.

Intensity Mod AMS [AMS Sources]

This selects a secondary AMS modulation source to scale the intensity of AMS2.

For a list of AMS sources, see “Alternate Modulation Source (AMS) List” on page 903.

Intensity [-99...+99]

This controls the depth and direction of the **Intensity Mod AMS**. Even if the main AMS2 Intensity is set to 0, Intensity Mod AMS can still control the final amount of AMS A over the full +/-99 range.

✓ 6-2: Page Menu Commands

- Compare →p.112
- Write Program →p.112
- Exclusive Solo →p.113

- PAGE →p.126
- MODE →p.126

6-3: Amp EG AMSource

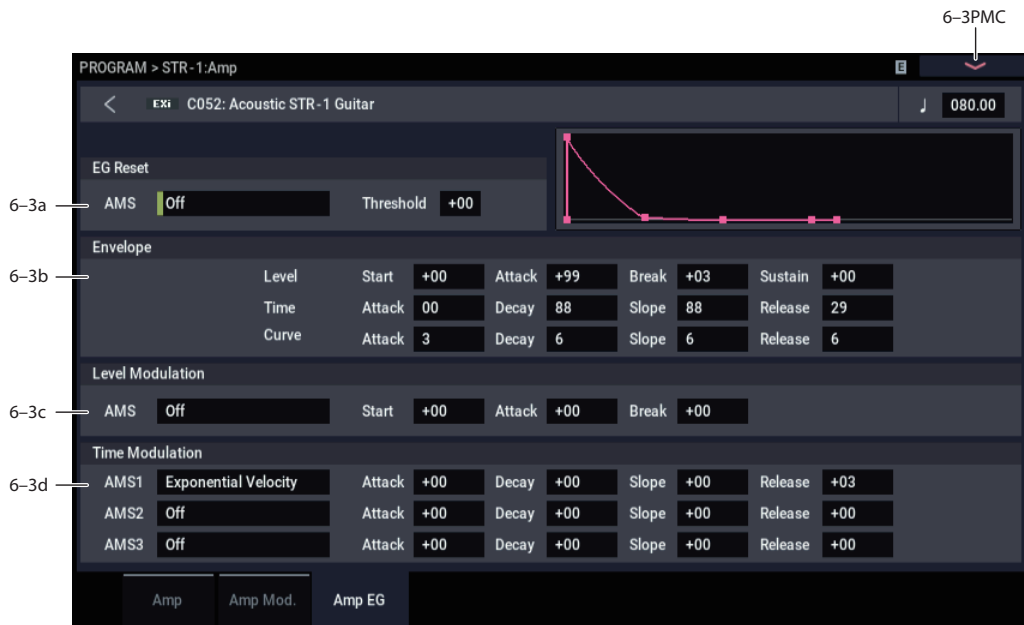

The STR-1's Amp EG is identical to the HD-1's. For more detailed explanations of the Amp EG features, please see “4-3: Amp1 EG,” on page 79.

Other envelopes can be used as additional controls via AMS, if desired.

6-3a: EG Reset

AMS

[AMS Sources]

This selects an AMS source to reset the EG to the start point. For instance, you can use a tempo-synced LFO to trigger the EG in a repeating rhythm. This reset is in addition to the initial note-on, which always causes the EG to start.

Note: Once the Amp EG is in its Release segment, it cannot be reset. (Otherwise, the sound might keep playing forever!)

For a list of AMS sources, see “Alternate Modulation Source (AMS) List” on page 903.

Threshold

[-99...+99]

This sets the AMS level which will trigger the EG reset. Among other things, you can use this to adjust the exact point in an LFO's phase at which the EG will be reset, effectively controlling its “groove” against other rhythmic effects.

When the threshold is **positive**, the EG triggers when passing through the threshold moving upwards. When the threshold is **negative**, the EG triggers when passing through the threshold moving downwards.

Note: With some LFO shapes, and with faster LFO speeds, the LFO may not always reach the extreme values of +99 or -99. In this case, setting the **Threshold** to these values may cause inconsistent behavior, or may mean that the EG doesn't reset at all. If this happens, reduce the **Threshold** until the EG triggers consistently.

6-3b: Amp EG

These parameters specify how the amp EG will change over time.

Amp EG

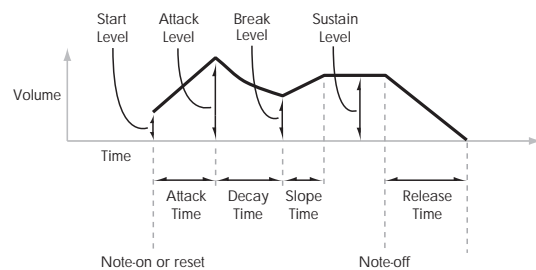

Level

Start

[00...99]

This sets the initial volume level at note-on.

Attack

[00...99]

This sets the level at the end of the Attack time.

Break

[00...99]

Break, short for Break Point, sets the level at the end of the Decay time.

Sustain

[00...99]

This sets the level at the end of the Slope time. Once it reaches the Sustain level, the EG will stay there until note-off (unless it is reset via AMS).

Time

Higher values mean longer times. For a chart showing equivalents in milliseconds, please see “Time” on page 80.

Attack [00...99]

This sets how long the EG takes to move from the Start level to the Attack level.

The minimum attack time is 2/3 of a millisecond—as fast as the most punchy of classic analog synths.

For the fastest possible attack time, you can set the Start level to +99; in this case, the EG will start instantaneously at its maximum value.

Decay [00...99]

This sets the time it takes to move from the Attack level to the Break level.

Slope [00...99]

This sets how long the EG takes to move from the Break level to the Sustain level. Once it reaches the Sustain level, the EG will stay there until note-off (unless it is reset via AMS).

Release [00...99]

This sets how long it takes the EG to move from the Sustain level to silence.

Curve

Classic analog synth envelopes created curved shapes naturally. The NAUTILUS goes a step further than vintage synths, however, and lets you control the amount of curvature separately for each of the four envelope segments.

When you change the curvature, the EG times remain the same. However, greater curvature will tend to *sound* faster, because the value changes more quickly at the beginning.

You may find that different amounts of curvature are suitable for segments which go up and segments which go down.

For instance, a curve of 3 is a good default setting for upward segments, such as Attack. On the other hand, a curve of 6 or more is good for downward segments, such as Decay and Release.

Attack [0 (Linear), 1...9, 10 (Exp/Log)]

This sets the curvature of the Attack segment - the transition from the Start level to the Attack level.

Decay [0 (Linear), 1...9, 10 (Exp/Log)]

This sets the curvature of the Decay segment - the transition from the Attack level to the Break level.

Slope [0 (Linear), 1...9, 10 (Exp/Log)]

This sets the curvature of the Slope segment - the transition from the Break level to the Sustain level.

Release [0 (Linear), 1...9, 10 (Exp/Log)]

This sets the curvature of the Release segment - the transition from the Sustain level to the Release level.

6-3c: Level Modulation

These settings let you use an AMS source to control the Level parameters of the EG. The Start, Attack, and Break levels share a single AMS source, but can each have different modulation intensities.

Note: Once the EG has started a segment between two points, that segment can no longer be modulated. For instance, if the EG is in the middle of the Decay time, you can no longer modulate either the Decay time or the Break level.

This also means that modulating the Start level, Attack level, or Attack time will not affect notes that are already sounding, unless the EG is then reset via AMS.

AMS [AMS Sources]

This selects an AMS source to control the EG's Level parameters.

For a list of AMS sources, see "Alternate Modulation Source (AMS) List" on page 903.

Start [-99...+99]

This controls the depth and direction of the AMS modulation for the Start level.

Attack [-99...+99]

This controls the depth and direction of the AMS modulation for the Attack level.

Break [-99...+99]

This controls the depth and direction of the AMS modulation for the Break level.

6-3d: Time Modulation

These settings let you use three different AMS sources to control the Time parameters of the EG. For each of the three AMS sources, the Attack, Decay, Slope, and Release times each have their own modulation intensities.

AMS1 [AMS Sources]

Selects the first AMS source to control the EG's Time parameters. Velocity and Keyboard Track can both be useful here, for instance.

For a list of AMS sources, see "Alternate Modulation Source (AMS) List" on page 903.

Attack [-99...+99]

This controls the depth and direction of the AMS modulation for the Attack time.

When the AMS source is at its maximum value—for instance, when Velocity is at 127—a setting of +8 will make the segment time almost twice as long, and a setting of -8 will cut the segment time almost in half.

Decay [-99...+99]

This controls the depth and direction of the AMS modulation for the Decay time.

Slope [-99...+99]

This controls the depth and direction of the AMS modulation for the Slope time.

Release [-99...+99]

This controls the depth and direction of the AMS modulation for the Release time.

AMS2 and AMS3

These select the second and third AMS sources, respectively, for controlling the EG's Time parameters. Each has its own intensities for Attack, Decay, Slope, and Release. The parameters of both AMS2 and AMS 3 are identical to those of AMS1, above.

✓ 6-3: Page Menu Commands

- Compare →p.112
- Write Program →p.112
- Exclusive Solo →p.113
- Copy Envelope →p.182
- Swap Envelope →p.182

- PAGE →p.126
- MODE →p.126

PROGRAM > STR-1: EG 1-4

The STR-1 has four assignable EGs, in addition to the Amp EG. Each of these can be used as an AMS modulation source to control a wide variety of parameters.

There are also two parameters with dedicated EG modulation inputs: Frequency for Filters A and B. Any of the four EGs can be used for these modulation routings.

In the midst of all this flexibility, we thought it would also be good to provide a little structure. With this in mind, EG 1 is named EG 1 (Filter), and EG2 is named EG 2 (Pitch).

Please take these names as suggestions, rather than restrictions. If you like, you're free to use these envelopes to control any EG or AMS destination, or to use other EGs to control Filter Frequency or Pitch.

7-1: EG 1 (Filter) AMSource

7-2: EG 2 (Pitch) AMSource

7-3: EG 3 AMSource

7-4: EG 4 AMSource

The STR-1's EGs 1-4 are identical to the AL-1's EG1. For detailed explanations, please see "7-1: EG 1 (Filter)," on page 169.

PROGRAM > STR-1: LFO 1-4

The STR-1 has four assignable LFOs, in addition to the EXi Program's Common LFO. Each of these can be used as an AMS modulation source to control a wide variety of parameters.

8-1: LFO 1 AMSource

8-2: LFO 2 AMSource

8-3: LFO 3 AMSource

8-4: LFO 4 AMSource

The STR-1's LFOs 1-4 are identical to those of the AL-1. For detailed explanations, please see "8-2: LFO 1," on page 175.

PROGRAM > STR-1: AMS Mixers/String Track

AMS Mixers

The AMS Mixers combine two AMS sources into one, or process an AMS source to make it into something new.

For instance, they can add two AMS sources together, or use one AMS source to scale the amount of another. You can also use them to modify the response of realtime controllers.

The AMS Mixer outputs appear in the list of AMS sources, just like other controllers.

This also means that the original, unmodified inputs to the AMS Mixers are still available as well. For instance, if you use Aftertouch as an input to a AMS Mixer, you can use the processed version of the Aftertouch to control one AMS destination, and the original version to control another.

Finally, you can cascade the AMS Mixers together—for instance, you can use AMS Mixer 1 as an input to AMS Mixer 2.

String Track

The **String Track** tracking generators allow you to scale parameters based on the string on which the note is played. This helps to model the sonic characteristics of the different strings, such as different materials (as with the nylon and steel strings of an acoustic guitar), different gauges of strings, and so on.

9-1: AMS Mixers 1/2

9-2: AMS Mixers 3/4

The STR-1's AMS Mixers are identical to those of the AL-1 (although the STR-1 has four, to the AL-1's two). For detailed explanations, please see "9-1: AMS Mixer," on page 179.

9-9: String Track AMSSource



Multi-stringed instruments, such as guitars, often include strings of different thicknesses, or strings created using different techniques or materials. For instance, strings may be:

- Round-wound, flat-wound, or un-wound
- Steel, brass, copper, or nylon
- Thicker (heavy-gauge) or thinner (light-gauge)

For instance, electric guitars may use wound low strings along with un-wound high strings. Similarly, classical guitars generally use nylon treble strings along with wound-metal bass strings.

This means that some strings may sound very distinct from others, quite aside from the differences in pitch. It's almost as if each string was a sub-instrument of its own.

In order to physically model these differences, it's sometimes helpful to modulate certain parameters separately for each string, such as **Damping**, **Decay**, **Dispersion**, **Inharmonicity**, etc.

String Track lets you do exactly this. It's a variation of keyboard tracking, which divides the keyboard into 6 zones, corresponding to 6 strings. You can then set four different offsets for each string: one each for **Damping** and **Dispersion**, and then the two general-purpose **String Track 1** and **2**. All four can be used as AMS sources throughout the STR-1.

Fret Number AMS Source

Strings may also change in timbre as you move up the neck, playing higher and higher notes. To model this, you can use an additional AMS source, **Fret Number**.

Fret Number provides the distance up the neck for the current note. When the note is an "open string," **Fret Number's** value is zero. As notes move up the fretboard, **Fret Number** increases. Once the next "open string" is reached, **Fret Number** goes back to zero, and starts over again.

9-9a: Fret Position AMSource

Fret Position **[Open, 1...48]**

This controls the position at which the notes are played along the neck. This can have a significant effect on the timbre, since it may change the string on which a note is played.

To do this, **Fret Position** shifts the relationship between notes played on the keyboard (or via MIDI) and the selected String pitches. This changes the break-points for all of the String Track generators at once.

This means that as the **Fret Position** increases, the same note will be played in higher positions on the neck, using lower strings.

The current fret position (in other words, the combination of **Fret Position** and its AMS) is itself available as the AMS source named, appropriately, **Fret Position**.

AMS **[List of AMS Sources]**

This selects a modulation source to control the **Fret Position**. For a list of AMS sources, see "Alternate Modulation Source (AMS) List" on page 903.

Intensity **[-48...+48]**

This controls the depth and direction of the **Fret Position** AMS modulation.

9-9b: Strings

Strings 1-6 **[C-1...G9]**

These six parameters set the pitches of the strings, from the lowest pitch (String 1) to the highest pitch (String 6). These define keyboard zones, as shown below.

The same String settings are used for all String Track generators, including those for Damping and Dispersion. They are also used for the Excitation, Harmonic, and Pickup positions when their **Tracking Mode** parameters are set to **String Track**.

For more information, see "4-5a: Excitation" on page 221, "4-5b: Harmonic" on page 223, "4-6a: Damping" on page 225, "4-6b: Dispersion" on page 225, "4-8a: Pickup 1" on page 230, and "4-8b: Pickup 2" on page 231.

String Track - strings and zones

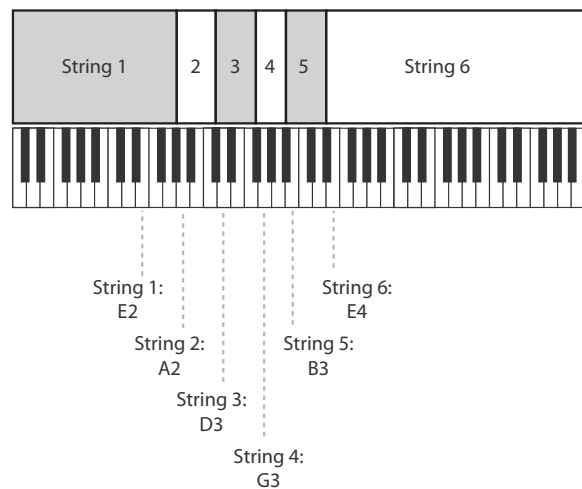

9-9c: String Track 1 AMSource

(Strings) 1...6 **[-100.0...+100.0]**

These set individual offsets for the six Strings. You can use these to modulate any AMS destination; they appear in the AMS list as String Track 1.

9-9d: String Track 2 AMSource

This is a second set of individual String offsets, which appear in the AMS list as String Track 2. The parameters are identical to those of "9-9c: String Track 1," above.

✓ 9-9: Page Menu Commands

- Compare →p.112
- Write Program →p.112
- Exclusive Solo →p.113
- PAGE →p.126
- MODE →p.126

STR-1: Tone Adjust

STR-1 Tone Adjust Default Settings

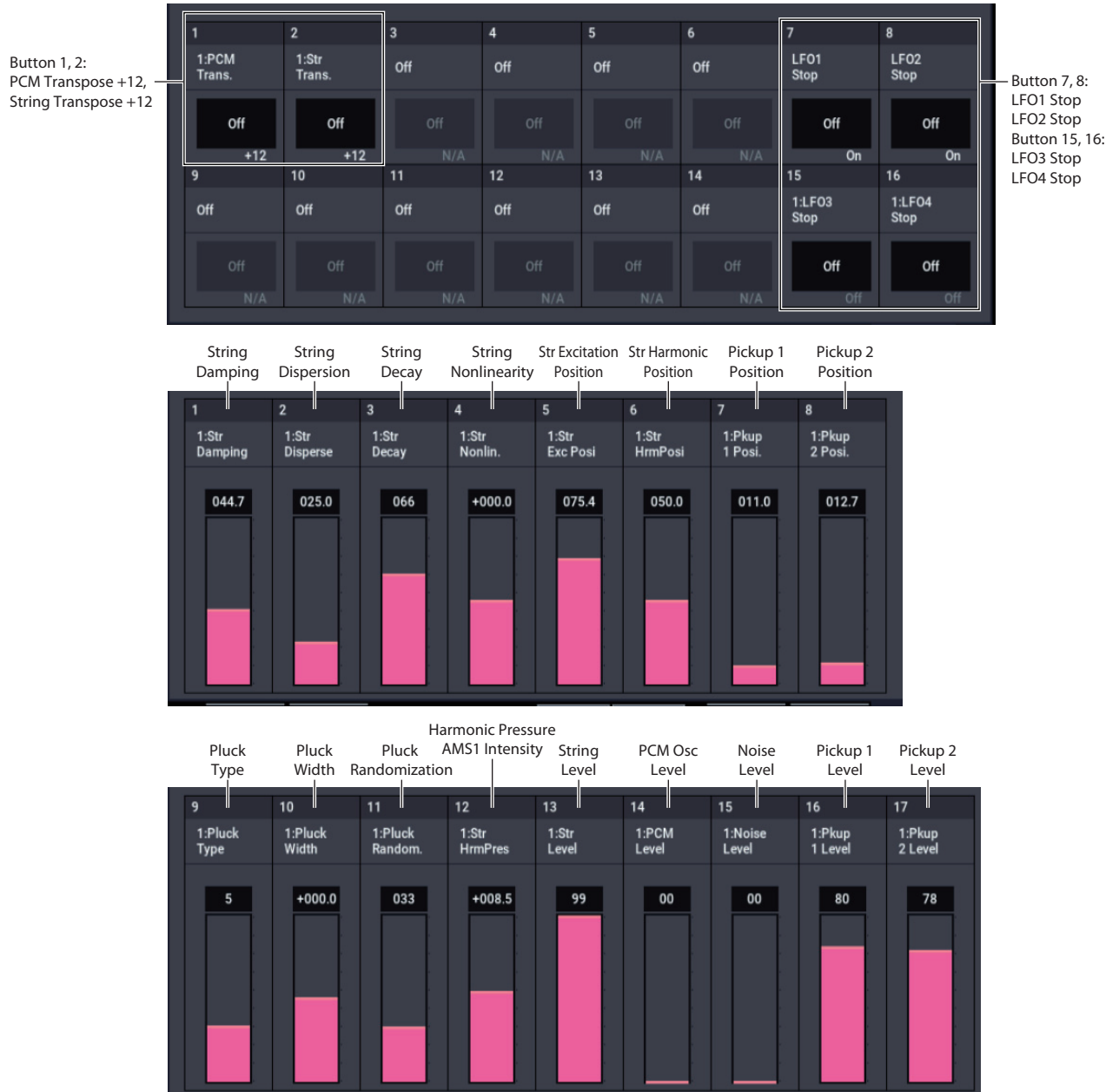

Tone Adjust provides an elegant physical interface to the STR-1’s parameters. Most of the factory sounds use the default layout, as shown above. You can also customize the layout for individual sounds, if desired.

For more information about Tone Adjust, please see “0–9a: Tone Adjust,” on page 29.

STR-1 Tone Adjust parameters

The STR-1 supports all of the Common Tone Adjust parameters, as described under “0–9a: Tone Adjust,” on page 29. It also adds a number of its own additional parameters, which apply only to the STR-1.

Note that these additional parameters are separate for each EXi, as opposed to being shared by both EXi in the Program.

All of the additional parameters are listed below. Tone Adjust parameters may affect the internal parameters in one of two ways: they may be **Relative**, in which case they scale

the existing parameter value, or **Absolute**, in which case they over-write the existing value. Unless otherwise noted, all of the STR-1 parameters are **Absolute**.

Pluck

- Pluck Type
- Pluck Randomization
- Pluck Delay
- Pluck Width
- Pluck Width AMS1 Intensity

Noise

- Noise Saturation
- Noise Filter Frequency

PCM Oscillator

- PCM Osc MS Select (PROG/0...16383)
- PCM Osc MS Bank (MS: ROM Mono...EXs7 Mono)
- PCM Osc MS Min # (meta)
- PCM Osc MS Max # (meta)
- PCM Osc Start Offset
- PCM Osc Reverse

PCM Pitch

- PCM Tune (-1200...+1200, relative)
- PCM Transpose (-12...+12, relative)
- PCM Pitch Slope
- PCM Pitch LFO AMS Intensity

Excitation Mixer

- Excitation PCM Oscillator level
- Excitation Pluck Level
- Excitation Noise Level

Excitation Filter

- Excitation Filter Type
- Excitation Filter Frequency
- Excitation Filter Resonance

String

- Excitation Position
- Harmonic Position
- Harmonic Pressure AMS1 Intensity
- Decay
- Nonlinearity
- Damping
- Dispersion

String Pitch

- String Tune (-1200...+1200, relative)
- String Transpose (-12...+12, relative)
- String Pitch Slope
- String Pitch LFO AMS Intensity

Pickups

- Pickup 1 Position
- Pickup 2 Position

Feedback

- Feedback Level AMS Intensity
- Feedback Distance AMS Intensity
- Feedback Orientation AMS Intensity

Mixer

- String Level
- PCM Oscillator Level
- Noise Level
- Pickup 1 Level
- Pickup 2 Level

Filter A

In addition to the standard Tone Adjust filter parameters, the STR-1 adds the following:

- Filter A Type
- Filter A Cutoff
- Filter A Resonance
- Filter A EG Intensity
- Filter A LFO Intensity

Filter B

Filter B has the same Tone Adjust parameters as Filter A, above.

Amp

- Amp AMS 1 Intensity
- Amp AMS 2 Intensity

EGs

In addition to supporting the standard Tone Adjust EG parameters, the STR-1 adds the following separate controls for both EG3 and EG4:

- Attack time (relative)
- Decay & Slope time (relative)
- Sustain level (relative)
- Release time (relative)

LFOs

In addition to supporting the standard Tone Adjust LFO parameters, the STR-1 adds the following separate controls:

- LFO 1, 2, 3, and 4 Waveform
- LFO 1, 2, 3, and 4 Shape
- LFO 3 Speed (relative)
- LFO 3 Fade (relative)
- LFO 3 Delay (relative)
- LFO 3 Stop
- LFO 4 Speed (relative)
- LFO 4 Fade (relative)
- LFO 4 Delay (relative)
- LFO 4 Stop

EXi STR-1: Page Menu Commands

| | |
|-----------------------|--------|
| Compare | →p.112 |
| Write Program | →p.112 |
| Exclusive Solo | →p.113 |
| Remap MS/Sample Banks | →p.121 |
| Copy Envelope | →p.182 |
| Swap Envelope | →p.182 |
| Copy LFO | →p.182 |
| Swap LFO | →p.182 |
| PAGE | →p.126 |
| MODE | →p.126 |

EXi: MS-20EX

MS-20EX Overview

The MS-20EX is a flexible, semi-modular virtual analog synthesizer. At its heart is a faithful re-creation of the original Korg MS-20, including both its features and its distinctive, often aggressive timbral signature.

To this core, we added features first introduced in the Korg Legacy MS-20 plug-in. Then, we added significant patch-panel modifications inspired by the MS-20's big brother, the MS-50, plus many other NAUTILUS-only enhancements. Features include:

- Korg's proprietary CMT (Component Modeling Technology)
- Up to 40-voice polyphony
- Two oscillators (including ring modulation), noise generator, and resonant, self-oscillating highpass and lowpass filters
- Many modifications to the Patch Panel, including separate access to VCOs 1 & 2, LPF, HPF, BPF, and VCA
- Two new patchable 2-in, 1-out audio-rate mixers, for combining and scaling audio and control signals
- Original MS-20 HADSR and DAR envelopes, plus four additional multi-stage EGs

- Original MS-20 MG and sample-and-hold, plus four additional LFOs
- AMS modulation of all original MS-20 parameters, along with four AMS Mixers
- Live audio input
- External Signal Processor, with dedicated filters, triggering, and audio-to-CV conversion
- Access to all standard EXi Program features, including the Common LFO, Common Step Sequencer, Key Track 1 & 2, Arpeggiator, EQ, and effects—as well as layering with any other EXi (including using two MS-20EXs together!)

MS-20EX uses EXi fixed resources

The MS-20EX takes up a very small amount of processing power, even if you're not playing any notes on the keyboard. This amount is around 1/12 that of the CX-3, but if other EXi are using large amounts of fixed resources, the number of MS-20EX that you can load may be limited. Each EXi in each Program counts towards the maximum; for instance, a Program with two MS-20EX's counts as two, not as one.

For more information, see "CX-3 & other EXi: Limitations on EXi fixed resources" on page 380.

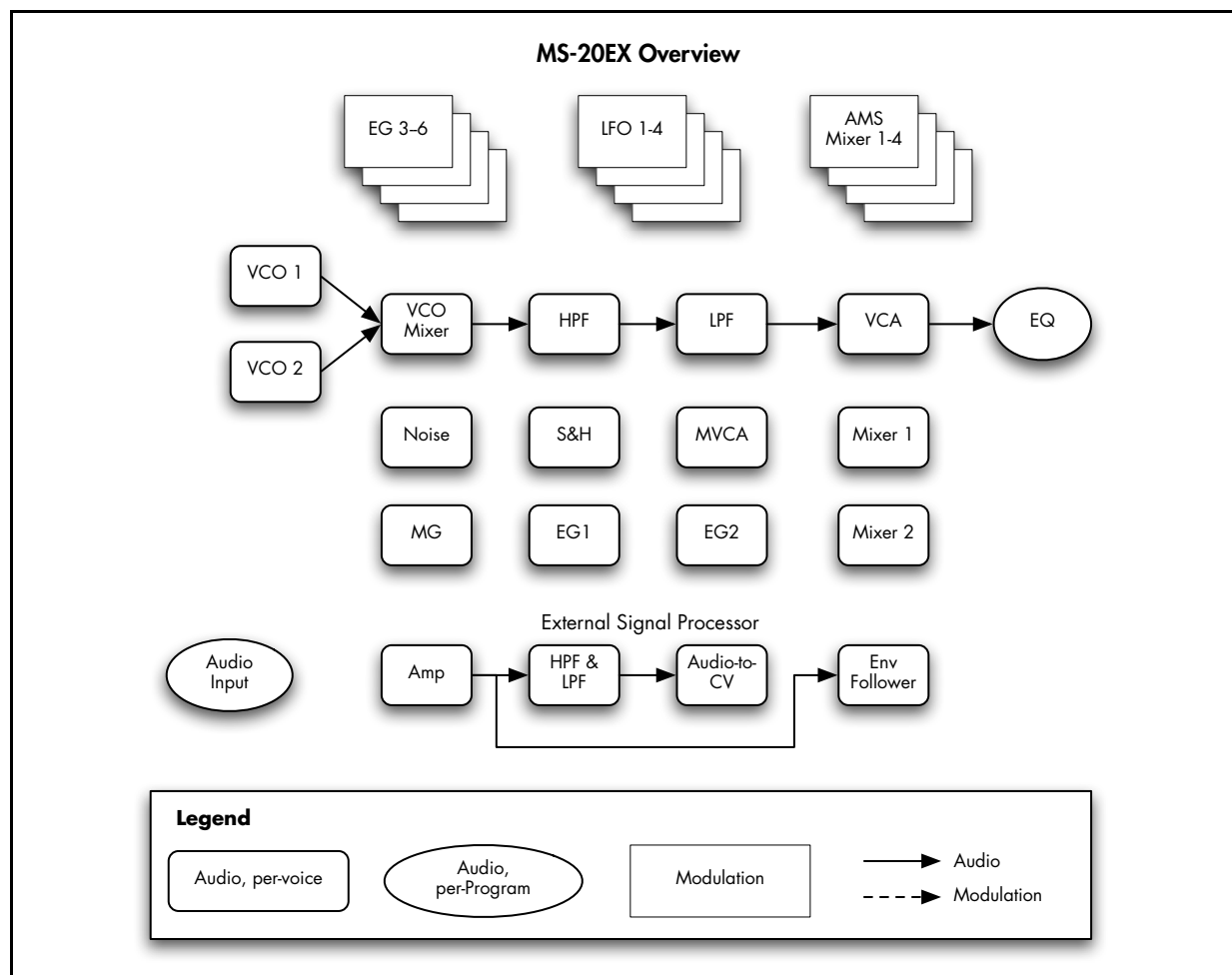

Unsupported EXi Common parameters

The MS-20EX supports all of the EXi Common parameters, except for two of the voice allocation options: **Poly Legato** and **Mono Mode** (Normal/Use Legato Offset).

All of the other voice allocation options are fully supported, including Mono, Mono Legato, Unison, etc.

On-screen knobs and switches and the Parameter Details area

Parameter Details

The LCD displays include graphic knobs for all of the main MS-20EX parameters. These let you view and edit parameters quickly and easily.

You can program any original MS-20 sound using only these knobs. If you want more flexibility and control, however, the MS-20EX offers four additional EGs and LFOs, four AMS mixers, access to the EXi Program's Common LFO, Common Step Sequencer, and AMS modulation for almost every original MS-20 parameter.

The entryway to these advanced features is the Parameter Details area, located in the lower right-hand part of the display. This shows information for the selected knob or switch, including its parameter group and parameter name, its exact value, and its AMS assignments:

Parameter Details area



Using the graphic parameters

Editing knobs

To edit knobs:

1. **Touch the knob.**

A yellow square will appear around the knob, showing that it has been selected. The Parameter Details area will change to show the name and value of the current parameter, along with other related information.

2. **Touch and then drag the knob to change its value. You can use either up-down or right-left gestures.**

or:

Use any of the VALUE controllers to edit the value.

You can use the +/- buttons, or the VALUE dial.

As you edit the value, notice that the graphic knob moves, and that the value in the Parameter Details area changes as well.

Editing on/off switches

To edit an on/off switch, such as the **MG KEY SYNC** button, simply:

1. **Touch the switch to toggle the value.**

Assigning AMS modulation

Most parameters support modulation via AMS. Sources and intensities can be edited in the Parameter Details area:

1. **Touch the knob.**

If the parameter supports AMS modulation, the Parameter Details area will show one or more AMS sources and intensities.

2. **Edit the AMS settings in the Parameter Details area.**

Note: The graphic knobs always show their stored value. Absolute Tone Adjust settings edit these values, just as if you were editing the parameters themselves, and so the graphics will show the results. However, AMS modulation does not edit the stored value, and so the graphics do not include the results of AMS.

Note also that AMS can sometimes modulate parameters outside the range of the stored values, as if you were pushing the parameter beyond the ends of the knob.

EXi PROGRAM > MS-20EX: Home

0-1: Overview



This is the main page of PROGRAM mode. For a full description of this page and all of its functions, please see “EXi PROGRAM > Home” on page 127. This section describes only the overview display, which differs for each individual EXi.

0-1b: Overview and Page Jump

This part of the page shows an overview of the most important settings for the Program’s two EXi instruments. The specific parameters will vary, depending on which EXi are being used. The specific parameters for the MS-20EX are described below.

The graphics give you a quick way to check all of these settings at a glance. They also let you jump instantly to any of the displayed parameters. Just touch one of the sections, and you’ll jump to the page containing its parameters. For instance, if you touch the Filter graphic, you’ll go to the Oscillator and Filter page.

Tip: Pressing EXIT several times will always bring you back to this page.

Oscillators and Filters

This section shows the waveforms for Oscillators 1 and 2, and the cutoff frequencies for the Highpass and Lowpass filters. Touch this area to jump directly to the Oscillators & Filters page.

MG/EG/Mod

This section shows the waveform and frequency of the MG, and the Attack and Release times for EGs 1 and 2. Touch this area to jump directly to the MG, EG, & Modulation page.

Patch Panel

This section shows a miniature overview of the Patch Panel, with its cables and jacks. Touch this area to jump directly to the Patch Panel page.

EGs and LFOs

EG 3...6 Graphics

These show the shapes of the four multi-stage EGs. Touch any of them to jump directly to the corresponding edit page.

LFO 1...4 Graphics

These show the waveforms and shapes of the four LFOs. Touch any of them to jump directly to the corresponding edit page.

Key Zone

Key Zone

This shows the key zones for EXi1 and EXi2, as set on the Common section’s Program Basic page, in relation to the entire MIDI note range. The range of the 61-, 73-, or 88-note keyboard is also shown, as appropriate.

Press this area to jump to the Program Basic page.

0-1d: Common

3Band EQ Graphic

Mute (1) [On, Off]

Mute (2) [On, Off]

Mute (DrumT) [On, Off]

EXi1 Instrument Volume [000...127]

EXi2 Instrument Volume [000...127]

Drum Track Volume [000...127]

This is the same as with HD-1 programs. For more information, please see "0-1d: Common" on page 4.

✓ 0-1: Page Menu Commands

- Compare →p.112
- Write Program →p.112
- Exclusive Solo →p.113
- Show MS/WS/DKit Graphics →p.113
- Add To Set List →p.113
- Initialize Program →p.113

- PAGE →p.126
- MODE →p.126

PROGRAM > MS-20EX: Oscillators & Filters

4-1: Oscillators & Filters

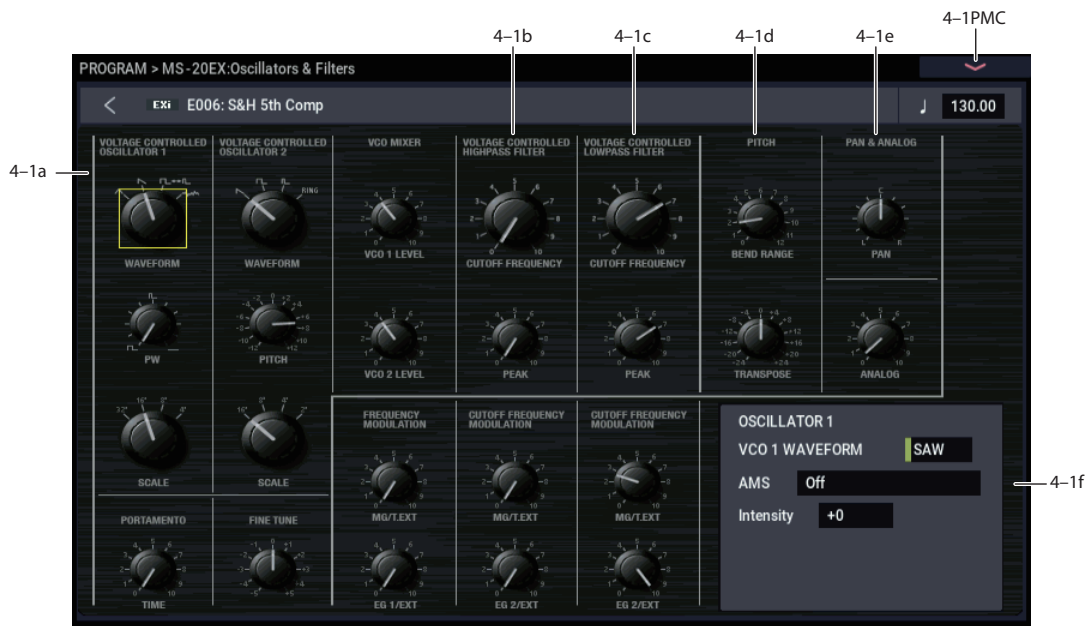

4-1a: Oscillators

VOLTAGE CONTROLLED OSCILLATOR 1

WAVEFORM [, , , ,]

This sets the basic timbre of Oscillator 1.

△ (Triangle Wave): This is a very basic waveform with few harmonics and a soft, rounded tone color. You can create a sine wave by processing the Triangle Wave through the Lowpass Filter. The original MS-20 manual notes that Triangle waves are “excellent for flute, vibes and other such effects.”

Note: The Triangle is a little more computationally intensive than the other waveforms, so using it will result in slightly lower polyphony.

∇ (Sawtooth): This is the foundation of the traditional, buzzy analog synth sound. The original MS-20 manual describes it this way: “A waveform rich in all the harmonics, and one of the most useful to the synthesist. Used for string, brass, voice and other harmonically rich sounds.”

□ ↔ ▭ (Square/Pulse Wave): This is a variable waveform shape, whose timbre depends upon the **PW** setting, as described below.

⚡ (White Noise): This is an un-pitched sound, containing equal amounts of all frequencies. The original MS-20 manual suggests using this for “wind, surf, gunshot, percussion, and other such effects.”

PW [0.00...10.00 (50%...0%)]

This adjusts the pulse width when Oscillator 1’s **Waveform** is set to **Square/Pulse**.

0.00 produces a square wave. Increasing the value produces narrower pulses, until at **10.00** the pulse is so narrow as to be silent.

The original MS-20 didn’t support pulse-width modulation, except by sweeping the knob manually. With the MS-20EX, however, you can modulate **PW** via AMS. Try using a medium-speed triangle LFO, or a sweeping EG.

More on Pulse Width

Pulse waveforms are simple, rectangular shapes. The Pulse Width sets the percentage of the waveform spent in the “up” position. A few examples are shown in the diagram below. Note that a square wave is just a pulse wave with **PW/PWM** set to **0.00**.

The width controls the timbre of the oscillator, from pure and hollow at **0.00** (a square wave) to thin, reedy, and nasal at higher settings.

At the maximum setting of **10.00**, the Pulse wave will be silent, since this eliminates the “pulse” altogether.

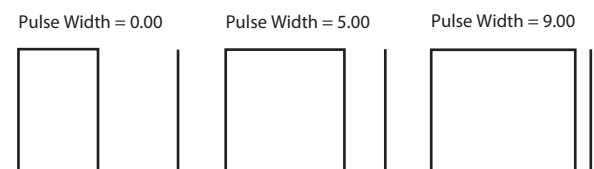



SCALE [32', 16', 8', 4']

Adjusts the pitch of Oscillator 1 in steps of an octave. With each halving of the “feet” value, the pitch goes up one octave. For example, **4'** is one octave higher than **8'**, and **16'** is one octave lower than **8'**.

VOLTAGE CONTROLLED OSCILLATOR 2**WAVEFORM** [ ,  ,  ,  , RING

This sets the basic timbre of Oscillator 2.

 (**Sawtooth**): This produces the traditional, buzzy analog synth sound. For more information, see “WAVEFORM” on page 259.

 (**Square Wave**): This is a hollow-sounding waveform, containing only odd-numbered harmonics. The original MS-20 manual notes that this is used to “simulate reed instruments and other closed pipe sounds.”

 (**Pulse Wave**): This is a relatively narrow pulse waveform, with a nasal tone quality and strong upper harmonics. The original MS-20 manual suggests that it be used to “simulate double reed instruments (e.g., the oboe) and certain plucked string sounds (e.g., harpsichord and clavinet).”

RING (Ring Modulator): This setting combines the two VCOs to create sums and differences of all their harmonics, creating a complex tone. The original MS-20 manual describes it this way: “The result is a clangorous, “metallic” sound which is useful for gong, chime and other such effects. **VCO 1** and **VCO 2 SCALE**, **PITCH**, and **PW** all affect the resulting sound, and should be used judiciously to create the desired effect.”

PITCH [-12.00...+12.00]

This adjusts the pitch of Oscillator 2 up and down by one octave, in one-cent steps. You can create thicker sounds by moving this slightly away from 0.00, so that the two oscillators beat against one another.

SCALE [16', 8', 4', 2']

This adjusts the pitch of Oscillator 2 in steps of an octave. Note that the range is one octave higher than that of Oscillator 1.

PORTAMENTO**TIME** [0.00...10.00]

This controls the amount of time it takes to glide from one pitch to the next.

 This is scaled by MIDI CC#5. You can also enable and disable Portamento using MIDI CC#65 (“Portamento Switch”). For more information, see “Assigning SW1 or SW2 to Portamento On/Off” on page 151

FINE TUNE**FINE TUNE** [-5.00...+5.00]

This adjusts the pitch of the oscillators, in steps of 1/5 of a cent (for a total range of +/- 1 semitone).

FREQUENCY MODULATION

Each of the FREQUENCY MODULATION controls affects both VCO 1 and VCO 2.

MG/T.EXT [0.00...10.00]

If nothing is connected to the patch panel’s **TOTAL** input jack, this adjusts the depth of pitch modulation from the MG’s Triangle Wave.

If a cable is connected to the **TOTAL** input jack, this controls the depth of pitch modulation from that signal.

For more information, see “TOTAL input jack” on page 269.

 This is scaled by MIDI CC#77.

EG1/EXT [0.00...10.00]

If nothing is connected to the patch panel’s **FREQ** jack, this controls the depth of pitch modulation from EG 1.

If a cable is connected to the **FREQ** jack, this controls the depth of pitch modulation from that signal.

With nothing connected to the **FREQ** jack, try increasing the **EG1/EXT** value, and then play a note on the keyboard. Notice that the pitch of the note rises and falls corresponding to EG 1’s **DELAY**, **ATTACK**, and **RELEASE** controls.

With the normalised connection to EG1, the pitch always starts low, rises to the played note, and then falls again on release. The setting of the EG1/EXT knob determines the low point of this modulation, while the high point stays constant.

You can create a different effect by manually patching the **EG1 OUT** jack into the **FREQ** jack. In this case, the pitch will start at the played note, rise up to the **EG1/EXT** setting, and then fall back to the played note.

VCO Mixer

This mixer controls the levels of the two VCOs into the Highpass Filter.

Note that both filters will show some amount of saturation and overdrive when their input levels are high, and **PEAK** settings are moderate or high. You can control the resulting tone by raising or lowering the VCO levels in this mixer.

VCO 1 LEVEL [0.00...10.00]

This adjusts the volume of Oscillator 1.

VCO 2 LEVEL [0.00...10.00]

This adjusts the volume of Oscillator 2.

4-1b: High Pass Filter**VOLTAGE CONTROLLED HIGHPASS FILTER**

This filter cuts out the parts of the sound which are **lower** than the cutoff frequency. You can use this to make timbres sound thinner or more buzzy, or to enhance bass sounds (see “Using the HPF as a sub-oscillator for bass sounds,” below).

FREQUENCY [0.00...10.00]

This controls the cutoff frequency of the Highpass Filter.

PEAK [0.00...10.00]

Peak controls the resonance of the filter, which emphasizes the frequencies around the cutoff frequency.

When this is set to **0**, there is no emphasis, and frequencies beyond the cutoff will simply diminish smoothly.

At medium settings, the resonance will alter the timbre of the filter, making it sound more nasal, or more extreme.

At very high settings, the resonance can be heard as a separate, whistling pitch. Near the maximum setting, the filter will self-oscillate.

PEAK and filter saturation

If the input level is high, raising the **PEAK** setting will cause increasing amounts of saturation and overdrive, creating a more aggressive tone. To control this, raise or lower the input level at the source—for instance, in the VCO MIXER.

Using the HPF as a sub-oscillator for bass sounds

With **PEAK** set relatively high, and **FREQUENCY** turned down low, the HPF can—somewhat counter-intuitively—be used to enhance low-end harmonics, creating thunderously deep bass sounds. To do so:

1. Start with a simple bass sound.
 2. On the Patch Panel, connect the KBD CV OUT to the HPF CUTOFF FREQ input.
- This allows the HPF to track the keyboard.
3. Set the HPF PEAK to around 7 or 8.
 4. Set the HPF FREQUENCY very low, but not quite at 0.
 5. Set the EG2/EXT knob to about 5.
 6. While playing the sound, adjust the FREQUENCY and EG2/EXT settings so that the filter resonance tracks the pitch correctly in the intended playing range.

With this setup, the resonance will only match the oscillator pitches over about one and a half octaves.

CUTOFF FREQUENCY MODULATION (HPF)**MG/T.EXT** [0.00...10.00]

If nothing is connected to the patch panel's **TOTAL** input jack, this adjusts the depth to which the MG will modulate the filter cutoff frequency.

If a cable is connected to the **TOTAL** input jack, this controls the depth of modulation from that signal.

For more information, see “TOTAL input jack” on page 269.

EG2/EXT [0.00...10.00]

If nothing is connected to the HPF's **CUTOFF FREQ** input jack, this adjusts the depth to which EG 2 will modulate the filter cutoff frequency.

If a cable is connected to the HPF's **CUTOFF FREQ** input jack, this controls the depth of modulation from that signal.

4–1c: Low Pass Filter**VOLTAGE CONTROLLED LOWPASS FILTER**

The Lowpass Filter cuts out the parts of the sound which are **higher** than the cutoff frequency. This is the most common type of filter, and is used to make bright timbres sound darker.

FREQUENCY [0.00...10.00]

This controls the cutoff frequency of the Lowpass Filter.

MIDI This is scaled by MIDI CC#74.

PEAK [0.00...10.00]

Peak controls the resonance of the filter, which emphasizes the frequencies around the cutoff frequency. For more information, see “PEAK,” above.

MIDI This is scaled by MIDI CC#71.

CUTOFF FREQUENCY MODULATION (LPF)**MG/T.EXT** [0.00...10.00]

If nothing is connected to the **TOTAL** input jack, this adjusts the depth to which the MG will modulate the filter cutoff frequency.

If a cable is connected to the **TOTAL** input jack, this controls the depth of modulation from that signal.

For more information, see “TOTAL input jack” on page 269.

EG2/EXT [0.00...10.00]

If nothing is connected to the LPF's **CUTOFF FREQ** input jack, this adjusts the depth to which EG 2 will modulate the filter cutoff frequency.

If a cable is connected to the LPF's **CUTOFF FREQ** input jack, this controls the depth of modulation from that signal.

MIDI This is scaled by MIDI CC#79.

4–1d: PITCH**BEND RANGE** [0.00...12.00]

This sets the maximum amount of pitch bend up and down, in semitones and cents, as controlled by JS X. To use another AMS source for pitch bend, modulate the **TRANSPOSE** parameter instead.

BEND RANGE is not modulatable via AMS.

TRANSPOSE [-24.00...+24.00]

This controls the coarse tuning, in half-steps and cents, up or down two octaves. You can modulate this smoothly via AMS.

4–1e: PAN & ANALOG**PAN** [Random, L001...C064...R127]

This controls the stereo pan of the MS-20EX, at the very end of the signal chain. A setting of **L001** places the sound at the far left, **C064** in the center, and **R127** to the far right.

When this is set to **Random**, the pan position will be different for each note-on.

MIDI You can also control pan via MIDI Pan (CC#10). A CC#10 value of 0 or 1 places the sound at the far left, 64 places the sound at the location specified by the “Pan” parameter, and 127 places the sound at the far right. This is controlled on the global MIDI channel (GLOBAL 1–1a).

Note: You can select Random pan only from the on-screen UI, and not from AMS or MIDI.

ANALOG [0.00...10.00]

This models the instability of an analog system by adding subtle randomization to the VCO and VCF frequencies.

This parameter is not modulatable.

4-1f: Parameter Details

When you touch a knob, a yellow square appears around it, showing that it has been selected.

This area shows details for the selected knob, including its parameter group and parameter name, its exact value, and its AMS assignments.

Individual parameters and AMS

The **BEND RANGE** and **ANALOG** parameters are not modulatable. **VCO1/2 WAVEFORM**, **VCO 1/2 SCALE**, and **PAN** have only one AMS source and Intensity, without Intensity Modulation. The rest of the parameters on this page can be modulated by two AMS sources, as described below.

(Parameter group)

This shows the group of the parameter (such as **VCO MIXER**).

(Parameter name) [range depends on parameter]

This shows the name and exact value of the parameter. You can edit the parameter value with any of the standard data-entry controls.

AMS [List of AMS Sources]

This selects a modulation source to control the selected parameter. For a list of AMS sources, see “Alternate Modulation Source (AMS) List” on page 903.

Intensity [range depends on parameter]

This controls the depth and direction of the AMS modulation. For unipolar parameters, the range is the same as that of the selected parameter, in both positive and negative directions. For instance, if the parameter range is 0.00...10.00, the Intensity range will be -10.00...+10.00.

For bipolar parameters, including **VCO 2 PITCH**, **FINE TUNE**, **TRANSPOSE**, and **MIXERS 1 & 2 LEVELS A & B**, the range is twice that of the original parameter. For instance, if the original parameter range is -12.00...+12.00, the Intensity range will be -24.00...+24.00. This allows full modulation of the parameter, regardless of the initial setting.

In some cases, you can use AMS to modulate the parameter outside of its original range, for a wider range of values.

Int. Mod AMS [List of AMS Sources]

You can modulate the main AMS Intensity from another AMS source. This selects that source.

For a list of AMS sources, see “Alternate Modulation Source (AMS) List” on page 903.

Intensity [range depends on parameter]

This controls the depth and direction of the Intensity Mod AMS. The result is summed with the main AMS Intensity to produce the final modulation amount.

✓ 4-1: Page Menu Commands

- Compare →p.112
- Write Program →p.112
- Exclusive Solo →p.113
- PAGE →p.126
- MODE →p.126

PROGRAM > MS-20EX: MG, EG, and Modulation

5-1: MG, EG, and Modulation

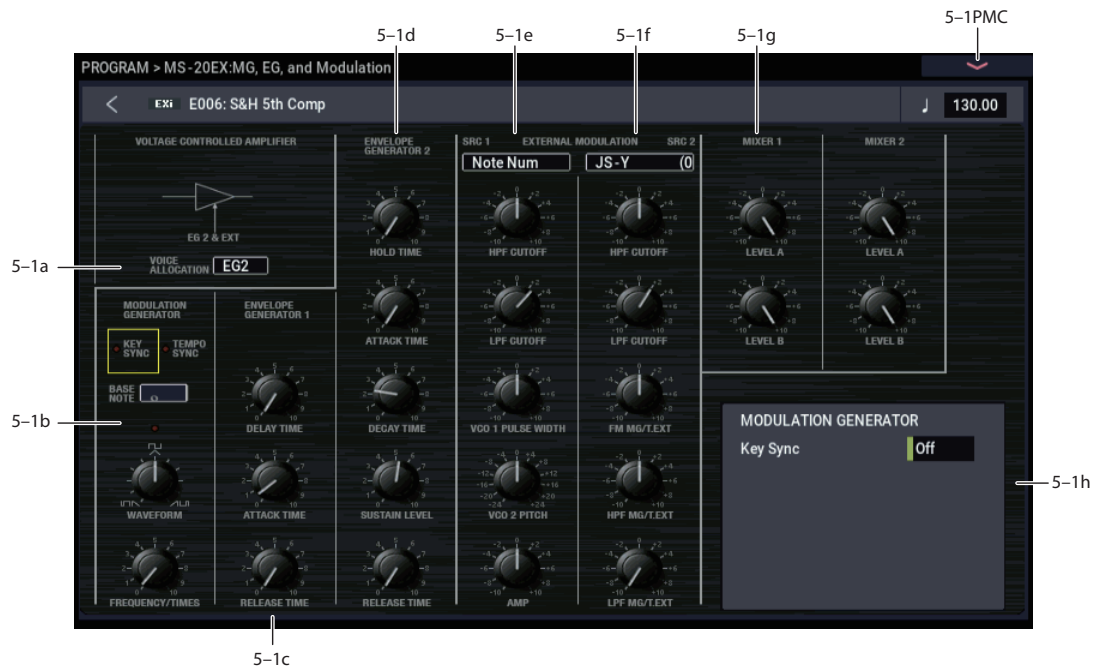
**5-1a: VOLTAGE CONTROLLED AMPLIFIER****VOICE ALLOCATION [EG1...EG6]**

When the EG selected here completes its release stage, the voice will be silenced, and its processor resources freed.

Normally, you should leave this at the default setting, EG2.

If EGs other than EG2 are modulating volume (see below), then select the volume-related EG with the longest release time.

Note: The EG selected here cannot be retriggered once it enters its release phase.

What does this mean, and when is it useful?

NAUTILUS allocates processing power automatically as you play and release notes. In order to do this, the system needs to know when a voice has finished playing.

With most EXi, the system does this by looking at the dedicated Amp EG; when the Amp EG completes its release, the system knows that the voice has finished.

The MS-20EX is more complicated than most EXi. Depending on the Patch Panel and AMS settings, several EGs may act together to control the output volume. For instance:

- EG 1 and EGs 3-6 may be routed to the Patch Panel's **VCA INITIAL GAIN** input
- EGs 3-6 may control the **VOLUME** knob via AMS
- Via AMS, EGs 3-6 may also control the levels of other modulation sources (such as EGs 1 & 2, the MG, LFOs, etc.) routed through MIXER 1 or MIXER 2, and then patched to the **VCA INITIAL GAIN** input

To handle all of these possible cases, instead of using a fixed "Amp EG" to determine when the voice is finished playing, the **VOICE ALLOCATION** parameter lets you select which EG to use.

For best results with any of these special-case setups, set **VOICE ALLOCATION** to use the volume-related EG with the longest release time.

5-1b: MODULATION GENERATOR (MG)

AMSsource

The MG is shared between all MS-20EX voices, similar to the Common LFO. For per-voice modulation, use **LFOs1-4** instead.

The saw/triangle and pulse/square waveforms are both generated all of the time, and available separately on the Patch Panel. Each is also available as an AMS source, named **MG Tri** and **MG Pulse**, respectively. Note that the AMS versions will have slightly softer edges than the signals available on the Patch Panel, and via the External Modulation sections.

TEMPO SYNC [ON, OFF]

Touch the text/LED area to turn **TEMPO SYNC** on and off.

On (LED lit): When **TEMPO SYNC** is **On**, the MG synchronizes to the system tempo, as set by either the Tempo or MIDI Clock. The MG speed is controlled by the combination of the **BASE NOTE** and **FREQUENCY/TIMES** parameters, below.

Off (LED dark): When **TEMPO SYNC** is **Off**, the **FREQUENCY/TIMES** knob determines the speed of the MG, and the **BASE NOTE** setting has no effect.

This parameter is not modulatable via AMS.

KEY SYNC [ON, OFF]

Touch the text/LED area to turn **KEY SYNC** on and off.

If this setting is **ON**, the phase is reset for the first note-on in each legato phrase. Subsequent notes in a chord, or notes played legato, do not cause the phase to be reset.

This parameter is not modulatable via AMS.

BASE NOTE [1/1...1/32]

When **TEMPO SYNC** is **ON**, this sets the basic speed of the MG, relative to the system tempo. The values range from a 32nd note to a whole note, including triplets. This value is then multiplied by the **FREQUENCY/TIMES** knob, below.

When **TEMPO SYNC** is **OFF**, this parameter has no effect.

This parameter is not modulatable via AMS.

WAVEFORM [ ...  ... ]

This controls the waveform of the **MODULATION GENERATOR**. The MG always generates both the Rectangle and Sawtooth/Triangle waveforms, and each is available simultaneously via the Patch Panel. The **WAVEFORM** knob controls the pulse width of the Rectangle wave, and makes the Sawtooth/Triangle “lean” from left to right, as shown in the graphics.

FREQUENCY/TIMES [0.00...10.00/16...1]

If **TEMPO SYNC** is **OFF**, this controls the frequency of the MG.

If **TEMPO SYNC** is **ON**, this multiplies the length of the **BASE NOTE**. For instance, if the **BASE NOTE** is set to a sixteenth note, and Times is set to 3, the MG will cycle over a dotted eighth note. Note that higher values mean a faster MG.

Frequency/Times LED

This LED gives a visual indication of the LFO speed. Note that the LED is **on** when the MG’s pulse/square waveform is **low**. Initially, this seems like the opposite of what one might expect. When using the MG to trigger the EGs, however, this makes perfect sense: the EGs start when the LED goes on, and release when the LED goes off.

5-1c: ENVELOPE GENERATOR 1

By default, EG 1 is triggered by note-ons. However, you can use the Patch Panel’s **TRIG IN** or **EG 1 TRIG IN** jacks to trigger it from a different source, such as the MG, AMS sources, or the ESP’s **TRIG OUT** jack. For more information, see “TRIG IN jack” on page 271.

EG1 is normalled to VCO frequency modulation (scaled by the **EG1/EXT** knob), as well as the MVCA control input (see “6-1f: Modulation VCA (MVCA)” on page 271).

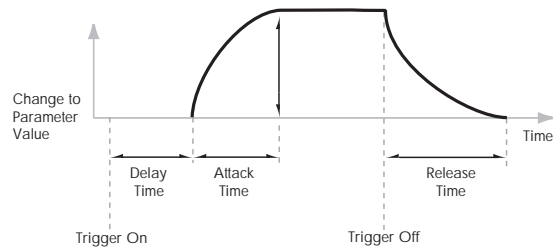
**DELAY TIME [0.00...10.00]**

Adjusts the time from when the trigger occurs (e.g., note-on) until the **ATTACK TIME** starts.

For standard attack-release behavior, set the **DELAY TIME** to 0.00.

ATTACK TIME [0.00...10.00]

Adjusts the time from the end of the **DELAY TIME** until the EG reaches its maximum value.

RELEASE TIME [0.00...10.00]

Adjusts the time from when the trigger is released (e.g., note-off) until the level decays to zero.

5-1d: ENVELOPE GENERATOR 2

By default, EG 2 is triggered by note-ons. However, you can use the Patch Panel’s **TRIG IN** jack to trigger it from a different source, such as the MG, AMS sources, or the ESP’s **TRIG OUT** jack. For more information, see “TRIG IN jack” on page 271.

EG 2 is hard-wired to the VCA, and also normalled to control the HPF and LPF. You can easily use other EGs for the filters, via AMS; using other EGs for the VCA is possible but slightly more tricky, as described under “Using EGs 3–6 to control the amplitude” on page 265.

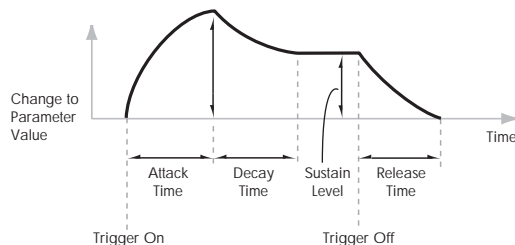

HOLD TIME [0.00...10.00]

Adjusts the time for which the input state of the trigger signal (e.g., note-on) is held after the trigger is released.

If the EG is triggered by a very short pulse, it may not have time to complete its attack and decay times before going into release. Increasing the **HOLD TIME** effectively makes the trigger pulse longer, giving the EG more time to complete its attack and decay.

EG 2 HOLD TIME

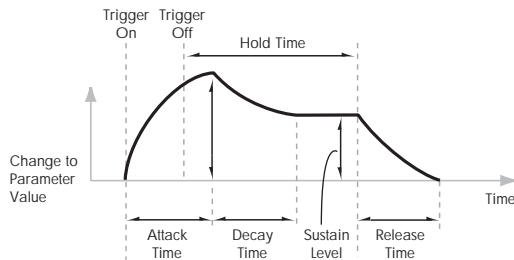

ATTACK TIME [0.00...10.00]

Adjusts the time from the EG trigger (e.g., note-on) until the EG reaches its maximum value.

MIDI This is scaled by MIDI CC#73.

DECAY TIME [0.00...10.00]

Adjusts the time the EG takes to descend from the peak to the sustain level. It also controls the rate at which **SUSTAIN LEVEL**, below, responds to AMS modulation.

MIDI This is scaled by MIDI CC#75.

SUSTAIN LEVEL [0.00...10.00]

Adjusts the sustain level. The EG will stay at this level until the trigger is released (such as when the note is released). Unlike most other EGs, this level responds to AMS modulation in realtime, moving at the programmed **DECAY TIME**.

MIDI This is scaled by MIDI CC#70.

Note: With the default connection to the **HPF** and **LPF** frequencies, this setting has a slightly unusual effect. The **SUSTAIN LEVEL** always produces the same effect as the setting of the **FREQUENCY** knob. The **EG2/EXT** setting controls the intensity of the filter modulation during the Attack, Decay, and Release portions of the envelope, but does not affect the Sustain at all.

Effectively, the EG shifts up and down **inversely** to the **SUSTAIN LEVEL**, as shown below. When the **SUSTAIN** is high, the EG shifts down; when the **SUSTAIN** is low, the EG shifts up.

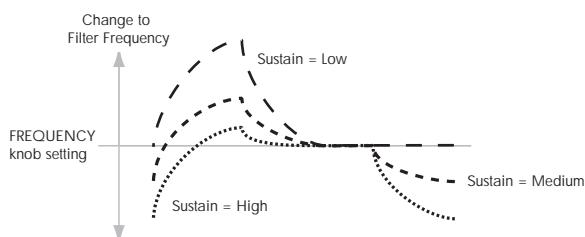

RELEASE TIME [0.00...10.00]

Adjusts the time from the trigger release (e.g., note-off) until the level decays to zero.

MIDI This is scaled by MIDI CC#72.

Using EGs 3-6 to control the amplitude

EG 2 is always connected to the VCA. It's possible, however, to force the VCA to its maximum value at all times, and then use AMS modulation of the main **VOLUME** knob to control the amplitude from any of the multi-segment EGs 3-6. To do so:

1. On the Patch Panel page, select the main **VOLUME knob**.
2. Set the **VOLUME knob** to 0.
3. Set the **VOLUME AMS Intensity** to +10.00.
4. Assign the desired EG (3-6) as the knob's AMS source.
5. Set the **VOICE ALLOCATION** parameter to the same EG.
6. In the Patch Panel, select the Mod Switch jack, which looks like this:
7. Set the Mod Switch AMS Source to AMS Mixer 1.
8. In AMS Mixer 1, set the Type to Gate, the Source to Note Number, and the Threshold to -99.
9. Set both Below Threshold and At & Above Threshold to fixed values of +33.

These settings produce a “5 volt” signal on the Patch Panel, which, when connected to the **INITIAL GAIN** input, sets the VCA to its maximum level. This lets you control the amplitude entirely via the **VOLUME AMS**.

10. On the Patch Panel, connect the Mod Switch jack to the VCA **INITIAL GAIN** input.
11. For the EG assigned in step 4, set up the times, levels, and curvatures as desired.

Remember to use curvature on the EG segments, for an analog feel!

5-1e: EXTERNAL MODULATION 1

Source [Off, MG Tri, MG Pulse, EG 1, EG 1 REV, EG 2, EG 2 REV, List of AMS Sources]

This selects the modulation source to control the parameters below. For a list of AMS sources, see “Alternate Modulation Source (AMS) List” on page 903.

HPF CUTOFF [-10.00...+10.00]

Specifies the depth and direction of the modulation applied to the high-pass filter (HPF) **CUTOFF FREQUENCY**.

LPF CUTOFF [-10.00...+10.00]

Specifies the depth and direction of the modulation applied to the low-pass filter (LPF) **CUTOFF FREQUENCY**.

VCO1 PULSE WIDTH [-10.00...+10.00]

Specifies the depth and direction of the modulation applied to the oscillator 1 (VCO1) **PULSE WIDTH**.

VCO2 PITCH [-24.00...+24.00]

Specifies the depth and direction of the modulation applied to the oscillator 2 (VCO2) **PITCH**, in semitones.

AMP [-10.00...+10.00]

Specifies the depth and direction of the modulation applied to the amp (VCA). This scales the combined effect of the **VOLUME knob** and its AMS modulation.

5–1f: EXTERNAL MODULATION 2

Source [Off, MG Tri, MG Pulse, EG 1, EG 1 REV, EG 2, EG 2 REV, List of AMS Sources]

This selects the modulation source to control the parameters below. For a list of AMS sources, see “Alternate Modulation Source (AMS) List” on page 903.

HPF CUTOFF [–10.00...+10.00]

Specifies the depth and direction of the modulation applied to the high-pass filter (HPF) CUTOFF FREQUENCY.

LPF CUTOFF [–10.00...+10.00]

Specifies the depth and direction of the modulation applied to the low-pass filter (LPF) CUTOFF FREQUENCY.

FM MG/T.EXT [–10.00...+10.00]

Specifies the depth and direction of the modulation applied to FREQUENCY MODULATION MG/T.EXT.

HPF MG/T.EXT [–10.00...+10.00]

Specifies the depth and direction of the modulation applied to the high-pass filter CUTOFF FREQUENCY MODULATION MG/T.EXT.

LPF MG/T.EXT [–10.00...+10.00]

Specifies the depth and direction of the modulation applied to the low-pass filter CUTOFF FREQUENCY MODULATION MG/T.EXT.

5–1g: Mixers

MIXER 1

This controls the input volumes for the Patch Panel’s Mixer 1. For more information, see “MIXER 1” on page 272.

LEVEL A [–10.00...+10.00]

This sets the level and polarity of the first input.

LEVEL B [–10.00...+10.00]

This sets the level and polarity of the second input.

MIXER 2

This controls the input volumes for the Patch Panel’s Mixer 1. For more information, see “MIXER 2” on page 273.

LEVEL A [–10.00...+10.00]

This sets the level and polarity of the first input.

LEVEL B [–10.00...+10.00]

This sets the level and polarity of the second input.

5–1h: Parameter Details

When you touch a knob, a yellow square appears around it, showing that it has been selected.

This area shows details for the selected knob, including its parameter group and parameter name, its exact value, and its AMS assignments.

Individual parameters and AMS

The EXTERNAL MODULATION knobs, BASE NOTE parameter, and TEMPO SYNC and KEY SYNC switches are not modulatable.

The rest of the parameters on this page can be modulated by AMS, as described below.

(Parameter group)

This shows the group of the parameter (such as VCO MIXER).

(Parameter name) [range depends on parameter]

This shows the name and exact value of the parameter. You can edit the parameter value with any of the standard data-entry controls.

AMS [List of AMS Sources]

This selects a modulation source to control the selected parameter. For a list of AMS sources, see “Alternate Modulation Source (AMS) List” on page 903.

Intensity [range depends on parameter]

This controls the depth and direction of the AMS modulation. For more information, see “Intensity” on page 262.

Int. Mod AMS [List of AMS Sources]

You can modulate the main AMS Intensity from another AMS source. This selects that source.

Intensity [range depends on parameter]

This controls the depth and direction of the Intensity Mod AMS. The result is summed with the main AMS Intensity to produce the final modulation amount.

✓ 5–1: Page Menu Commands

- Compare →p.112
- Write Program →p.112
- Exclusive Solo →p.113
- PAGE →p.126
- MODE →p.126

PROGRAM > MS-20EX: Patch Panel

6-1: Patch Panel

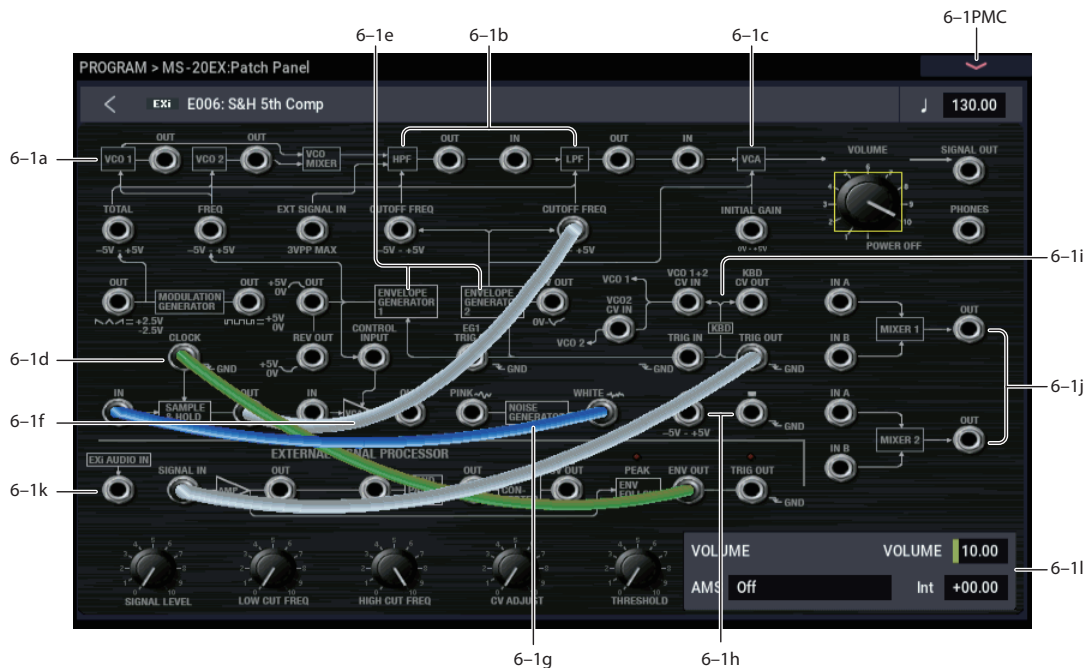

Using the Patch Panel

Basic patching rules

Most of the main sections of the MS-20EX, including the VCOs, filters, MG, EGs, and so on, are connected by default, even without using any patch cables. The lines and arrows on the Patch Panel show these “normal” signal paths.

Plugging a cable into an input jack disconnects the “normal” path, and uses the signal from the cable instead. For example, the MG is normalled to the TOTAL input jack. If you connect the EG1 OUT jack to the TOTAL input, this disconnects the MG.

Each input can be connected to a single output, and no more (although a single *output* can be connected to multiple *inputs*, as described below). If you want to route two outputs to a single input, use one of the mixers to merge the outputs first.

Plugging a cable into an output jack lets you use the signal elsewhere on the patch panel, and does not interrupt the “normal” path. You can also connect a single output to any number of inputs, if you like; this is sometimes called a “mult.” The signal strength remains the same, as if you were using a distribution amplifier.

Connections from one input to another, or from one output to another, are not allowed.

Making connections

You can make connections between patch points in two different ways, as described below.

Touch-drag method

1. **Touch one of the two jacks (either input or output), and drag your finger across the screen to the second jack.**

A yellow line appears as you drag across the screen, and is replaced by a patch cable once the connection is made.

Touch method

1. **Touch one of the two jacks (either input or output).**

A yellow square will appear around the selected jack. The Detail Panel will also show the name of the selected jack, and what it is connected to.

2. **Touch the same jack again.**

The yellow square will begin to blink, showing that you’re about to make a connection. To cancel this and return to the normal selected state, just touch the same jack a third time.

3. **Touch the other jack.**

The two jacks will now be connected.

Deleting connections

You can delete connection between patch points in two different ways.

Touch-drag method

1. **Touch the input jack, and drag off of the jack.**

The selected connection will be deleted.

Touch method

1. **Touch the input jack.**

Note: You can also select the output jack. However, if the output is connected to more than one input, all of the connections from that output will be affected, as described below.

2. Press the Disconnect button in the Detail Panel.

The selected connection will be deleted.

Deleting all connections from an output

You can delete all connections from an output at once—convenient if the output has been connected to multiple inputs.

Touch-drag method

1. Touch the input jack, and drag to the Disconnect button in the Detail Panel.

All of the output's connections will be deleted.

Touch method

1. Touch the output jack.

2. Press the Disconnect button in the Detail Panel.

All of the output's connections will be deleted.

Clearing all connections from the Patch Panel

To completely clear the Patch Panel, so that you can start from scratch:

1. Open the menu, and select the Delete All Connections command.

All connections will be deleted.

Different jacks have different voltage scales

Pay attention to the voltage indications (0~+5V, -5V~+5V, 5Vp-p, GND, etc.) on the Patch Panel, and their relationships to the block diagram and signal flow chart.

For instance, if you connect a -5~+5V control signal to a 0~+5V input jack, nothing will happen during the -5~0V portion of the control signal. It will only operate from 0V to +5V. Always consider both the characteristics of the output and the input.

Patch Panel modifications - new inputs/outputs shown in red

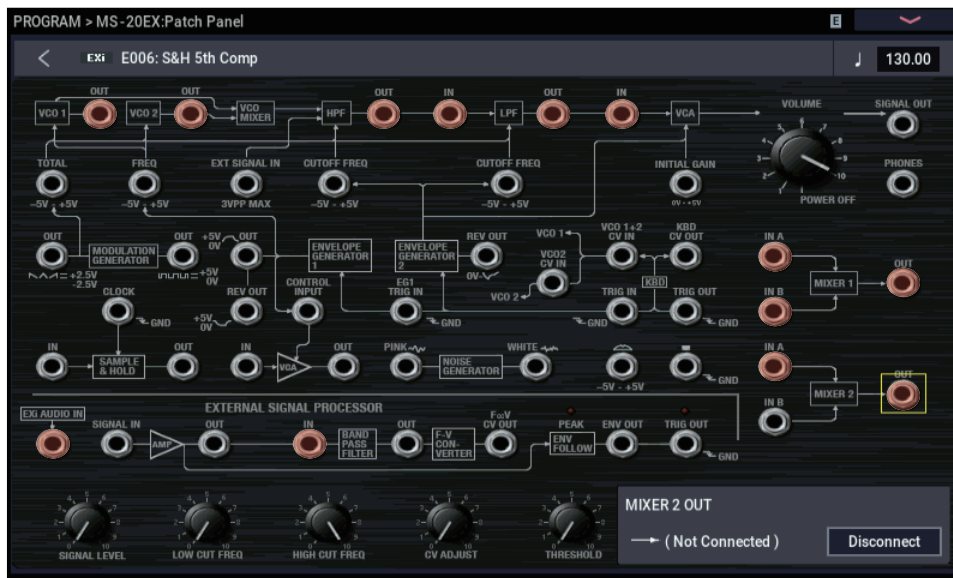

Patch Panel modifications

In comparison to the original MS-20, the MS-20EX has some important additional features on the Patch Panel. These include:

- Individual access to each of the two oscillators, two filters, and final VCA
- Separate **EXi AUDIO INPUT** and **BAND PASS FILTER IN**, which allow you to route signals through the band pass filter and/or frequency-to-cv converter, while using the audio input separately
- Dual two-input mixers with phase inversion

These modifications open up many new possibilities, such as:

- Route **VCO 1** through the **HPF**, and **VCO 2** through the **LPF** (or vice-versa)
- Mix **VCO 1** and **VCO 2** together, and then route the mix through the **HPF** and **LPF** in parallel, instead of in series

- Use AMS of the **MIXER LEVELS** to modulate the relative levels of these parallel filters, from physical controllers, LFOs, EGs, etc.
- Route any audio source (such as a VCO or the **NOISE GENERATOR**) through the **BAND PASS FILTER**, and then mix the results back in to either the **HPF** or **LPF**, or to the final **VCA**
- Invert the polarity of a modulation or audio signal via **MIXER 1** or **2**
- Use **VCO1** or **2** to modulate **LPF** or **HPF** cutoffs, or **VCA** gain
- Reverse the order of the **LPF** and **HPF** (most noticeable with high **PEAK** settings)
- ...and many more avenues for you to explore on your own.

Tip: Creating self-triggering patches

Normally, new notes and EGs 1 and 2 are triggered by playing notes on the keyboard. They don't have to be, however. You can use the MG Square/Pulse output, the Trig Out of the External Signal Processor, or AMS signals from the Wheel or Switch jacks to trigger one or both EGs.

Note: EGs 1 and 2 trigger when the input is at 0 ("low"), such as when the MG Square/Pulse is in the bottom portion of the waveform. The MG's indicator LED is on during this portion of the waveform.

You can also use AMS (such as LFOs) to reset EGs 3-6, if desired. Finally, the Common Step Sequencer and LFO can also be reset via a selection of controllers, including the X-Y Envelope CCs.

Even when a patch is self-triggering, it will only play when a note is played on the keyboard, held by the damper pedal, or held via the Program Basic page's **Hold** parameter. When the note is released (by lifting up on the keyboard or damper pedal, or turning off **Hold**), the EG selected by the **VOICE ALLOCATION** parameter will automatically enter its release phase, and will no longer re-trigger. All other EGs will continue to re-trigger, according to the Patch Panel and AMS settings.

In some cases, you may want some elements of the patch to re-trigger automatically, while others are still triggered from the keyboard. To allow the keyboard to act as a trigger while you are holding the sustain pedal (or while **Hold** is enabled):

1. Select the **KBD TRIG OUT** jack.
2. In the Parameter Details box, set **Trigger On to Note Gate**.

For more information, see "KBD TRIG OUT jack" on page 275.

6-1a: VCOs 1 and 2



For descriptions of the VCO parameters, see "4-1a: Oscillators" on page 259.

(VCO 1) OUT jack

This Patch Panel modification provides the output of VCO 1.

(VCO 2) OUT jack

This Patch Panel modification provides the output of VCO 2.

TOTAL input jack

This input modulates the frequencies of VCOs 1 and 2, the HPF, and the LPF. It's normalised to the MG sawtooth/triangle output, but you can use patch cables to connect any other modulation source.

Each of the destinations has a knob to scale the amount of modulation from the TOTAL input. For more information, see:

- VCO 1 and 2 pitch: "MG/T.EXT" on page 260
- HPF frequency: "MG/T.EXT" on page 261
- LPF frequency: "MG/T.EXT" on page 261

FREQ input jack

This input modulates the frequencies of VCOs 1 and 2. The signal is scaled by the EG1/EXT knob, as described under "EG1/EXT" on page 260.

VCO CV (Control Voltage) inputs

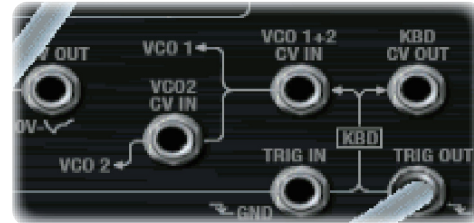

VCO 1+2 CV IN jack

This controls the basic pitch of both VCO1 and VCO2.

Normally, this signal comes from the notes played on the keyboard (or via MIDI). You can patch other signals into this jack to create special effects, or to follow the pitch of an external audio input.

VCO 2 CV IN jack

This is similar to "VCO 1+2 CV IN jack," above, but affects VCO 2 only.

6-1b: HPF and LPF

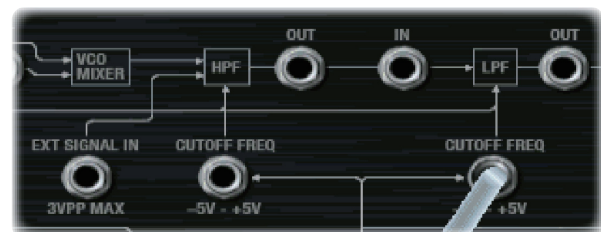

EXT SIGNAL IN jack

This is a direct input to the HPF, summed with the output of the VCO Mixer.

(HPF) CUTOFF FREQ input jack

This input modulates the cutoff frequency of the Highpass Filter.

(HPF) OUT jack

This Patch Panel modification provides the output of the Highpass Filter.

(LPF) CUTOFF FREQ input jack

This input modulates the cutoff frequency of the Lowpass Filter.

(LPF) IN jack

This Patch Panel modification provides a direct input to the Lowpass Filter.

(LPF) OUT jack

This Patch Panel modification provides the output of the Lowpass Filter.

6-1c: VCA, VOLUME, and outputs



VCA IN jack

This Patch Panel modification provides a direct input to the main VCA.

INITIAL GAIN input jack

The VCA is internally patched to the output of EG 2.

This jack allows an external controller to vary the VCA *in addition to* EG 2.

When the sum of both controllers reaches 5 volts, no further changes in volume will occur.

VOLUME [POWER OFF, 0.01...10.00]

This controls the basic volume level of the MS-20EX. Note that you can modulate this via AMS, for each individual voice; for more information, see “Using EGs 3–6 to control the amplitude” on page 265.

MIDI and volume

MIDI You can control the Program’s overall volume via MIDI using both Volume (CC#7) and Expression (CC#11). When used one at a time, the two controllers work in exactly the same way: a MIDI value of 127 is equal to the **VOLUME** setting, and lower values reduce the volume.

If both CC#7 and CC#11 are used simultaneously, the one with the *lower* value determines the maximum volume, and the one with the higher value scales down from that maximum.

SIGNAL OUT jack

On the original MS-20, this was the final output. With the MS-20EX, you may find it useful for routing the overall output signal back into the patch—such as for creating a feedback loop.

Note that connecting to this jack does not mute the output signal.

PHONES output jack

On the original MS-20, this was used for headphones (of course!). With the MS-20EX, you can use it to route the overall output signal back into the patch, as with the “SIGNAL OUT jack,” above.

Since its original purpose was to drive headphones, the gain of the **PHONES** output is about 15dB higher than that of the **SIGNAL OUT**. It also clips (with distortion) at around -5dB below the max output level.

6-1d: MODULATION GENERATOR and SAMPLE & HOLD

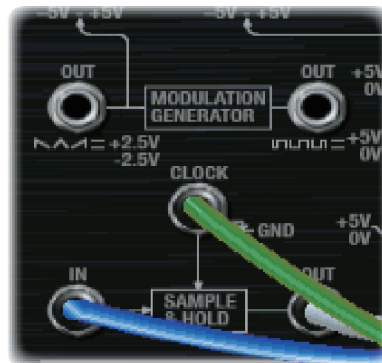

MODULATION GENERATOR (MG)

The MG has separate outputs for its two basic waveforms, so that you can use both simultaneously.

For descriptions of the MG parameters, see “5-1b: MODULATION GENERATOR (MG)” on page 263.

OUT jack (saw/triangle)

This is the output for the saw/triangle waveform. The signal is centered around zero, from -5.00 to +5.00.

OUT jack (pulse/square)

This is the output for the pulse/square waveform. The signal is unipolar, from 0.00 to 10.00.

Note: When used through AMS and EXTERNAL MODULATION, the signal ranges for both the saw/triangle and pulse/square are -10.00 to +10.00.

SAMPLE & HOLD

The **SAMPLE & HOLD** can generate a stepped output from any varying input. You can use this to create random filter or pitch effects, arpeggios, quantized LFOs or EGs, and so on.

To use the **SAMPLE & HOLD**, there must be a trigger source connected to the **CLOCK** input, and some sort of signal (such as the **NOISE GENERATOR**, **VCOs**, **AMS** sources etc.) connected to the **IN** jack.

When the **CLOCK** input is high, the **OUT** jack will carry a slightly filtered version of the signal from the **IN** jack. If the **CLOCK** input goes high for a very brief period of time, then the input from that instant will be “held” at the output. The output then stays “held” until the next time that the **CLOCK** input goes high.

Important: the trigger at the **CLOCK** input must be very brief. When using the MG Rectangle waveform as the trigger, for instance, turn the **WAVEFORM** knob to the extreme right position; this produces a very sharp pulse.

With this caveat in mind, you can use the MG or the LFOs to trigger the **CLOCK** at regular intervals, or trigger it manually using a switch, keyboard trigger out, or other signal.

CLOCK input jack

This input controls the timing of the S&H, as described above.

IN jack

This is the input to the S&H. You can connect this to the noise generator, a VCO, an LFO, etc.

OUT jack

This is the output of the S&H, which carries the held, “steppy” signal.

Creating the classic sample-and-hold effect

To create the classic random-stepping sample-and-hold effect, for rhythmic, bubbling filters or “computer noise” pitch effects:

1. Connect the **WHITE** or **PINK** output of the **NOISE GENERATOR** to the **SAMPLE & HOLD IN** jack.
2. Connect the **MG RECTANGLE** output to the **CLOCK** input.
3. On the **MG, EG, & MODULATION** page, turn the **MG WAVEFORM** knob all the way to the right.
4. Connect the **SAMPLE & HOLD OUT** to the modulation destination.

For instance, the **LPF CUTOFF FREQ IN** jack, or the **VCO 1+2 CV IN** jack.

5. Adjust the **MG FREQUENCY** to control the speed of the sample & hold effect.

Generating a random value at note-on

Using noise as the input signal, you can generate a random value at note-on by connecting the **KBD TRIG OUT** to the **CLOCK** input. This will also let through additional values at note-off, which may or may not be desirable.

If you’d prefer to generate a random value at note-on only:

1. Connect the **WHITE** or **PINK** output of the **NOISE GENERATOR** to the **SAMPLE & HOLD IN** jack.
2. Connect the **Switch** output to the **CLOCK** input.
3. Leave the **Switch AMS** source set to **Off**.

With the **AMS** source set to **Off**, it will automatically trigger the **CLOCK** at note-on, but not do anything else.

Of course, you can also route a real **AMS** source to the **CLOCK** input, and trigger it manually or via an **LFO**, **Step Sequencer**, etc.

For a more diffuse, “splatty” effect, try connecting **EG1 REV** to the **CLOCK** input.

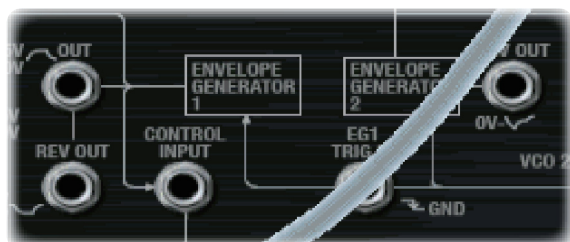
6-1e: ENVELOPE GENERATORS 1 and 2**EG outputs**

For descriptions of the EG parameters, see “5-1c: ENVELOPE GENERATOR 1” on page 264, and “5-1d: ENVELOPE GENERATOR 2” on page 264.

EG 1 OUT jack

This allows you to route **EG 1** to another point on the Patch Panel.

Note that, when manually connected to the **VCO FREQ** input, this produces a different result than the normalled signal; for more information, see “EG1/EXT” on page 260.

EG 1 REV OUT jack

This is the inverted shape of **EG 1**. The signal starts at the maximum value, falls to 0, and then releases back to the maximum value.

EG 2 REV OUT jack

This is the inverted shape of **EG 2**. The signal starts at the maximum value, falls to 0, rises up to the sustain level, and then releases back to the maximum value.

Trigger inputs**TRIG IN jack**

This lets you use an external trigger sources (such as the **MG** rectangle output, the trigger output of the **ESP**, or a switch controller via **AMS**) to trigger both **EG 1** and **EG 2**.

The EGs trigger when the **TRIG IN** moves from high to low, such as when the **MG** Rectangle wave switches to the bottom portion of the waveform. When the **TRIG IN** signal goes high again, the EGs enter their release phase.

Note that the **MG**’s **LED** is **on** when it is **low**. Initially, this seems like the opposite of what one might expect. When using the **MG** to trigger the EGs, however, this makes perfect sense: the EGs start when the **LED** goes on, and release when the **LED** goes off.

EG 1 TRIG IN jack

This is similar to the **TRIG IN** jack, above, but it triggers Envelope Generator 1 only.

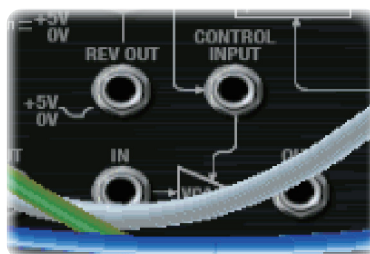
6-1f: Modulation VCA (MVCA)

This is a second VCA, intended for scaling modulation signals.

For instance, to create a delayed vibrato:

1. Connect the **MG triangle wave output** to the **MVCA input**

2. Connect the **MVCA output** to the **TOTAL input**

EG 1 is normalled to the **CONTROL** input, so without any additional connections, you can simply:

3. Adjust the EG 1 Delay and Attack controls to create the desired delay and fade-in times

CONTROL INPUT jack

This controls the level of the MVCA. It's normalled to the EG 1 output, but you can patch in any other control signal. This input includes built-in lowpass filtering, which acts as a smoother on the control signal.

IN jack

This is the input to the VCA. Unlike the CONTROL INPUT, this does not have any lowpass filtering.

OUT jack

This is the output of the VCA—the input signal scaled by the control signal.

6–1g: NOISE GENERATOR



These outputs provide pink and white noise, respectively. You can use these as sound sources or as modulation signals.

PINK output jack

Pink noise has a darker sound than white noise, with reduced high frequency components.

WHITE output jack

White noise is classic broad-band noise.

Note that white noise is also available as a waveform in VCO 1.

6–1h: Mod Wheel and Mod Switch



The Mod Wheel and Switch jacks allow you to select any AMS source (controllers, EGs, LFOs, step sequencer etc.), scale it via Intensity, and then route the signal into the patch panel.

For more information, see “Mod Wheel and Mod Switch” on page 275.



(Mod Wheel) jack

This lets you select, scale, and route the first AMS signal. This could be the Mod Wheel, if you wish—but it could also be any other AMS source.



(Mod Switch) jack

This lets you select, scale, and route the second AMS signal. You can use any AMS source, including continuous sources such as LFOs and EGs; the selection is not limited to on/off switches.

6–1i: Keyboard Trigger and CV outputs



KBD CV OUT jack

This allows you to route the keyboard's control voltage (which is a signal representing the current note) to other parts of the synthesizer.

KBD TRIG OUT jack

Whenever you play a key on the keyboard, a trigger signal is generated.

Using the Parameter Details box, you can select whether this trigger represents **Note Gate + Sustain**, or **Note Gate** only.

Note Gate + Sustain is the default, and is most appropriate for general use.

Note Gate is useful for keyboard trigger operation within self-triggering patches. For more information, see “Tip: Creating self-triggering patches” on page 269.

6–1j: MIXERS 1 and 2

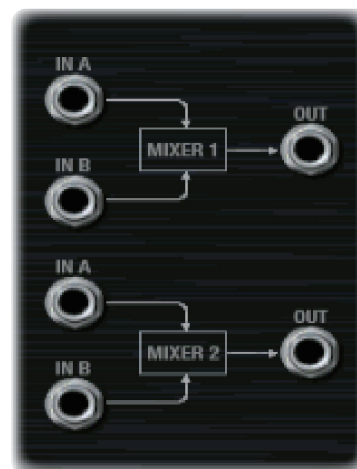

MIXER 1

This is a simple 2-in, 1-out mixer; you can use it for merging and scaling either control or audio signals. Note that you can also use this to invert the polarity of a signal.

The levels of inputs A and B are controlled by knobs on the MG, EGs, and Modulation page, and can be modulated via AMS; for more information, see “5–1g: Mixers” on page 266.

IN A jack

This is the first input to the mixer.

IN B jack

This is the second input to the mixer.

OUT jack

This is the merged output of **IN A** and **IN B**.

MIXER 2

This is a second 2-in, 1-out mixer, identical to “MIXER 1,” above.

IN A jack

This is the first input to the mixer.

IN B jack

This is the second input to the mixer.

OUT jack

This is the merged output of IN A and IN B.

6-1k: EXTERNAL SIGNAL PROCESSOR (ESP)

Important: the ESP is only active when notes are played

The ESP can process live audio inputs, feedback from effects, or any other audio from within the NAUTILUS—as well as audio from within the MS-20EX itself. Note, however, that the ESP is only active when a voice is being played on the MS-20EX.

It’s easy to make a patch in which only the incoming audio is heard, with the built-in VCOs completely silent—but you still need to press a key (or play a note via MIDI) in order to activate the MS-20EX. You can use the EXi Common **Hold** parameter to keep the note “held down” indefinitely, if you like.

For more information, see “Using the External Signal Processor (ESP)” on page 274, and “Tip: Creating self-triggering patches” on page 269.

Audio Inputs



EXi AUDIO IN jack

This mono input lets you route audio from elsewhere in NAUTILUS through the MS-20EX. You can use any of the audio inputs, any of the audio outputs, the REC buses, the FX Control buses, or the outputs of any of the Insert, Master, or Total Effects.

You can also route live or recorded audio through the MS-20EX, in real-time—and we’re sure that you’ll be able to think of other creative uses!

The audio input source and channel (left, right, or L+R summation) are selected by the Input Source and Channel parameters in the current Program, Combination Timbre, or Song Track.

For more information, see “4-2: EXi Audio Input” on page 134 (PROGRAM mode), “2-6: EXi Audio Input” on page 412 (COMBINATION mode), and “2-6: EXi Audio Input” on page 487 (SEQUENCER mode).

Once you’ve selected the desired audio source, you can connect the **EXi AUDIO IN** jack to any input on the Patch Panel. For instance, you can route the audio through the

HPF, LPF, or BPF, mix it with the built-in VCOs and noise generator, and so on. You can also use the ESP to convert the audio to a trigger or CV source, as described under “Using the External Signal Processor (ESP),” on page 274.

The **EXi AUDIO IN** is monophonic, but you can use two MS-20EX together to process stereo signals:

1. **Create a double EXi Program, and assign both EXi1 and EXi2 to use the MS-20EX.**
2. **In the EXi Audio Input parameters, assign the left channel to EXi1, and the right channel to EXi2.**
3. **Pan the output of EXi1 to the left, and the output of EXi2 to the right.**

Note: In the Legacy MS-20 plug-in, the audio input is normalised to the HPF’s Ext Signal Input. To enable more flexibility in patching, this signal is *not* normalised in the MS-20EX. When converting sounds from the Legacy plug-in, the EXi audio input should be patched to the Ext Signal In jack.

SIGNAL IN jack

This is the input to the External Signal Processor. To use this with live audio input, connect the **EXi AUDIO IN** jack to the **SIGNAL IN** jack.

SIGNAL LEVEL knob [0.00...10.00]

This adjusts the volume of the signal connected to the **SIGNAL IN** jack.

This knob has over 50dB of gain at the maximum setting of **10.00**. Unity gain (+0dB) is at **3.75**; **5.00** is about +4dB, and **7.50** is about +12dB.

If the input level is high, setting above unity gain will cause increasing amounts of saturation and overdrive, creating a more aggressive tone.

(SIGNAL) OUT jack

This is the signal from the **SIGNAL IN** jack, scaled by the **SIGNAL LEVEL** control.

BAND PASS FILTER

The Bandpass filter includes separate controls for high and low cut, and passes through only the audio between those two frequencies. It’s normalised to the input of the Frequency-to-Voltage converter, for fine-tuning the incoming audio.

You can also use this filter to process audio signals, or to sculpt the Noise Generator’s output for particular modulation effects. You can even use it as a third filter for the VCOs, in addition to the HPF and LPF.

Note: Even at the widest settings for high and low cut, there will still be some attenuation of the highest and lowest frequencies.



(BAND PASS FILTER) IN jack

This Patch Panel modification provides a direct input to the Bandpass filter. This means that you can use the filter separately from the Envelope Follower, if desired.

LOW CUT FREQ knob [0.00...10.00]

This knob adjusts the low-cut frequency of the Bandpass filter. Only frequencies **higher** than this will pass through the filter.

HIGH CUT FREQ knob [0.00...10.00]

This knob adjusts the high-cut frequency of the Bandpass filter. Only frequencies **lower** than this will pass through the filter.

(BAND PASS FILTER) OUT jack

This is the output of the Bandpass filter.

Frequency-to-Voltage (F×V) CONVERTER

This converter generates a “control voltage” signal based on the pitch of the audio input, which you can then use to control the pitch of the VCOs.

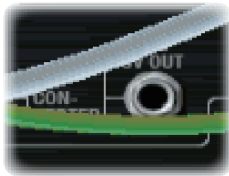
**CV ADJUST knob [0.00...10.00]**

Adjust this so that the input signal and the synthesizer’s output signal are the same pitch. For more information, see “Using the External Signal Processor (ESP)” on page 274.

F×V CV OUT jack

This is the output of the F-V CONVERTER. You can connect this to the VCO 1+2 CV IN or VCO 2 CV IN jacks, to control the oscillator pitch.

ENVELOPE FOLLOWER and TRIG OUT

The **ENVELOPE FOLLOWER** creates a control signal out of the audio input level. For instance, you could connect the **ENV OUT** to the **LPF CUTOFF FREQ** input, to create an auto-wah filter.

The **ENVELOPE FOLLOWER** takes its input from the volume-scaled **SIGNAL IN**, right after the **SIGNAL LEVEL** knob.

Similarly, the **TRIG OUT** creates a trigger signal from the input. Use the **THRESHOLD** knob to set the volume level at which the trigger occurs.

**PEAK LED [Off, On]**

This LED shows that the **ENVELOPE FOLLOWER** is at its peak value. You can use this as an aid when adjusting the input signal’s level and/or frequency content for optimal performance.

ENV OUT jack

This is the output of the **ENVELOPE FOLLOWER**. Connect this to any modulation input.

THRESHOLD knob [0.00...10.00]

This sets the volume level at which the trigger occurs. Adjust this to match the

TRIG OUT jack

This is the trigger generated from the audio signal. You can connect this to the EG 1&2 **TRIG IN** jack, the **EG1 TRIG IN** jack, or the **SAMPLE & HOLD CLOCK** input.

TRIG OUT LED [Off, On]

This LED shows that input signal is over the trigger **THRESHOLD**, and that the trigger output is on. You can use this as an aid when adjusting the **THRESHOLD**, **LOW CUT FREQ** and **HIGH CUT FREQ** controls, or when using other controls to modify the input signal.

Using the External Signal Processor (ESP)

You can use the ESP to control the MS-20EX from an external monophonic audio source, such as a melody played on a guitar. Just like the original MS-20, the MS-20EX will trigger its EGs and track the pitch of the guitar—with varying degrees of accuracy. Of course, the unpredictability is part of the charm...

Note that this will only work with single-note input, such as melodies; polyphonic input will not work properly.

You can also use the ESP as a modulation source when processing audio signals through the MS-20EX. This can be very useful with drums, for instance; you can use the input signal to trigger EGs, use the ESP’s envelope follower to modulate the filters, and so on.

Important: the ESP only works if an MS-20EX note is being played! You can use the Hold parameter, or a damper pedal, to sustain a single note indefinitely if desired.

To set up the ESP for external control:

1. **If you are using a live input, connect the instrument or microphone to the NAUTILUS audio inputs, and set up the gain accordingly.**
2. **On the EXi Audio Input page, select the desired input.** For more information, see “4–2: EXi Audio Input” on page 134 (PROGRAM mode), “2–6: EXi Audio Input” on page 412 (COMBINATION mode), and “2–6: EXi Audio Input” on page 487 (SEQUENCER mode).
3. **On the Patch Panel, connect the EXi AUDIO INPUT to the SIGNAL IN.**
4. **Play a note on the keyboard, or via MIDI. Use either the damper pedal or the HOLD parameter to keep the note sustained.**

The ESP is only active when a note is being played.

5. **Increase the THRESHOLD while watching the TRIG OUT light, until it lights when playing at medium to high volumes.**

The light shows when the signal is over the trigger threshold.

6. **Connect the ESP’s TRIG OUT jack to the TRIG IN jack.**

This makes EG1 and EG2 respond to the ESP’s trigger output, instead of the keyboard.

7. Connect the ENV OUT jack to the VCA's INITIAL GAIN jack.

This makes the VCA level follow the amplitude of the ESP's signal, as generated by the envelope follower.

8. Connect the F×V CV OUT jack to the VCO 1+2 CV IN jack (or the VCO 2 CV IN jack).

This makes the pitch of the VCOs follow the pitch of the ESP's signal.

9. In the BAND PASS FILTER, set the LOW CUT FREQ to 10.00 and HIGH CUT FREQ to 0.00.

10. Play the highest note the ESP is to pick up, and slowly increase the HIGH CUT until the desired pitch is picked up.

11. Play the lowest note and slowly decrease the LOW CUT until the note is picked up.

These measures help to refine the CV converter's response to the input signal.

12. Set the CV ADJUST control so that the pitch matches that of the input instrument.

The MS-20EX should now respond to the audio input, as if you were playing on the keyboard.

6-1: Parameter Details

The parameter details box shows different information depending on whether the current selection is an input or output jack, a knob, or one of the two assignable mod sources (the wheel and switch).

Input and Output Jacks

If a jack is selected, this area shows the name of the selected jack on the top line, and the jack(s) to which it is connected on the bottom line, to the right of the arrow. If nothing is connected to the jack, the bottom line reads "(No Connection)."

If the selected jack is an output connected to multiple inputs, only the first connection is shown, followed by an ellipse.



Disconnect button

Pressing the **Disconnect** button clears all cables connected to the jack.

Mod Wheel and Mod Switch

In addition to the functionality described under "Input and Output Jacks," above, these jacks allow you to select any AMS source, use Intensity to scale the signal, and then route it into the patch panel.

Note that the Mod Switch can use any AMS source, including continuous sources such as LFOs and EGs; it is not limited to on/off switches.



AMS

[List of AMS Sources]

This selects the modulation source to route into the patch panel. For a list of AMS sources, see "Alternate Modulation Source (AMS) List" on page 903.

Important: on the original MS-20, the Mod Wheel was a bipolar modulation source—meaning that the center position produced no modulation, moving down from the center made the value lower, and moving up from the center made the value higher.

The MS-20EX has a number of bipolar modulation sources, including the LFOs, EGs 3-6, and the Common Step Sequencer. JS+Y (the equivalent of the Mod Wheel), on the other hand, is unipolar.

You can use an AMS Mixer to convert JS+Y into a bipolar signal, if you like. To do so:

1. On the AMS Mixer page, set the Mixer Type to Offset.
2. Select JS+Y as AMS A.
3. Set AMS A Offset to -99.
4. Set AMS A Amount to +199.

These settings shift JS+Y down and then double its range, creating a bipolar signal.

5. In the Patch Panel, set the Mod Wheel jack to use the AMS Mixer (instead of JS+Y).

The Mod Wheel jack will now carry the bipolar JS+Y signal.

Int (Intensity) [range depends on parameter]

This controls the depth and polarity of the AMS signal.

KBD TRIG OUT jack

In addition to the functionality described under "Input and Output Jacks," above, this jack lets you select the trigger type, as below.

Trigger On [Note Gate + Sustain, Note Gate]

Note Gate + Sustain is the default, and is most appropriate for general use.

Note Gate is useful for keyboard trigger operation within self-triggering patches. For more information, see "Tip: Creating self-triggering patches" on page 269.



Knobs

If a knob is selected, this area shows its parameter group and parameter name, its exact value, and its AMS assignments. All six Patch Panel knobs, including Master Volume, are modulatable.

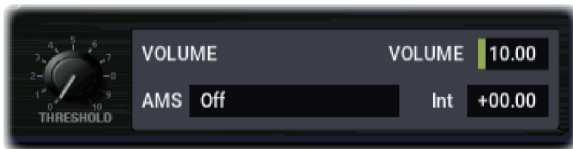

(Parameter group)

This shows the group of the parameter (such as VCO MIXER).

(Parameter name) [range depends on parameter]

This shows the name and exact value of the parameter. You can edit the parameter value with any of the standard data-entry controls.

AMS [List of AMS Sources]

This selects a modulation source to control the selected parameter. For a list of AMS sources, see “Alternate Modulation Source (AMS) List” on page 903.

Int (Intensity) [range depends on parameter]

This controls the depth and direction of the AMS modulation.

✓ 6-1: Page Menu Commands

- Compare →p.112
- Write Program →p.112
- Exclusive Solo →p.113
- Delete All Connections →p.282
- PAGE →p.126
- MODE →p.126

PROGRAM > MS-20EX: EG

The MS-20EX has four assignable EGs, in addition to the original MS-20 EGs 1 and 2. Each of these can be used as an AMS modulation source to control a wide variety of parameters.

7-1: EG 3 AMSource

7-2: EG 4 AMSource

7-3: EG 5 AMSource

7-4: EG 6 AMSource

The MS-20EX's EGs 3-6 are identical to the AL-1's EG1. For detailed explanations, please see "7-1: EG 1 (Filter)," on page 169.

PROGRAM > MS-20EX: LFO

The MS-20EX has four assignable LFOs, in addition to the original MS-20 MG and the EXi Program's Common LFO. Each of these can be used as an AMS modulation source to control a wide variety of parameters.

8-1: LFO 1 AMSource

8-2: LFO 2 AMSource

8-3: LFO 3 AMSource

8-4: LFO 4 AMSource

The MS-20EX's LFOs 1-4 are identical to those of the AL-1. For detailed explanations, please see "8-2: LFO 1," on page 175.

PROGRAM > MS-20EX: AMS Mixers

The AMS Mixers combine two AMS sources into one, or process an AMS source to make it into something new.

For instance, they can add two AMS sources together, or use one AMS source to scale the amount of another. You can also use them to modify the response of realtime controllers.

The AMS Mixer outputs appear in the list of AMS sources, just like other controllers.

This also means that the original, unmodified inputs to the AMS Mixers are still available as well. For instance, if you use Aftertouch as an input to a AMS Mixer, you can use the processed version of the Aftertouch to control one AMS destination, and the original version to control another.

Finally, you can cascade the AMS Mixers together—for instance, you can use AMS Mixer 1 as an input to AMS Mixer 2.

9–1: AMS Mixers 1/2

9–2: AMS Mixers 3/4

The MS-20EX's AMS Mixers are identical to those of the AL-1 (although the MS-20EX has four, to the AL-1's two). For detailed explanations, please see "9–1: AMS Mixer," on page 179.

MS-20EX: Tone Adjust

MS-20EX Tone Adjust Default Settings



Tone Adjust provides an elegant physical interface to the MS-20EX’s parameters. Most of the factory sounds use the default layout, as shown above. You can also customize the layout for individual sounds, if desired.

For more information about Tone Adjust, please see “0–9a: Tone Adjust,” on page 29.

Common Tone Adjust parameters

These parameters affect both EX1 and 2. Except as noted below, the Common Tone Adjust parameters behave as described under “Common Tone Adjust Parameters,” on page 31.

Filter Cutoff. (–99...+99, CC#74)

This scales the cutoff frequency of the lowpass filter. To adjust the highpass filter, use the separate, MS-20EX-specific Tone Adjust parameters.

Filter Resonance. (–99...+99, CC#71)

This scales the resonance (**PEAK**) of the lowpass filter. To adjust the highpass filter, use the separate, MS-20EX-specific Tone Adjust parameters.

Filter EG Intensity. (–99...+99, CC#79)

This scales the **EG2/EXT** knob for the lowpass filter.

Amp Velocity Intensity. (–99...+99)

Not supported.

Filter/Amp EG Attack Time.

(–99...+99, CC#73)

This scales the attack time of EG2, which is normalised to both filter cutoff and amplitude.

Filter/Amp EG Decay Time.

(-99...+99, CC#75)

This scales the decay time of EG2. It interacts with CC# 75.

Filter/Amp EG Sustain Level.

(-99...+99, CC#70)

This scales the sustain level of EG2.

Filter/Amp EG Release Time.

(-99...+99, CC#72)

This scales the release time of EG2.

Filter EG, Amp EG, and Pitch EG Attack Time, Decay Time, Sustain Level, Release Time are not supported by the MS-20EX.

Pitch LFO1 Intensity. (-99...+99, CC#77)

This scales the **FREQUENCY MODULATION MG/T.EXT** knob. (Note that this controls the amount of pitch modulation, but does not necessarily apply to LFO1.)

MS-20EX Tone Adjust parameters

In addition to the Common Tone Adjust parameters listed above, the MS-20EX adds a number of its own parameters.

Note that these additional parameters are separate for each EXi, as opposed to being shared by both EXi in the Program.

All of the additional parameters are listed below. Tone Adjust parameters may affect the internal parameters in one of two ways: they may be **Relative**, in which case they scale the existing parameter value, or **Absolute**, in which case they over-write the existing value. Unless otherwise noted, all of the MS-20EX parameters are **Absolute**.

VCO1

VCO1 WAVEFORM

VCO1 PW

VCO1 Scale

VCO2

VCO2 WAVEFORM

VCO2 Pitch

VCO2 Scale

PORTAMENTO

Portamento Time

FINE TUNE

Fine Tune

FREQUENCY MODULATION

Freq Mod MG/T.Ext

Freq Mod EG1/Ext

VCO Mixer

VCO 1 Level

VCO 2 Level

HPF

HPF Frequency

HPF Peak

CUTOFF FREQUENCY MODULATION (HPF)

HPF Mod MG/T.Ext

HPF Mod EG2/Ext

LPF

LPF Frequency

LPF Peak

CUTOFF FREQUENCY MODULATION (LPF)

LPF Mod MG/T.Ext

LPF Mod EG2/Ext

PITCH

Bend Range

Transpose

MODULATION GENERATOR (MG)

MG Key Sync

MG Tempo Sync

MG Base Note

MG Frequency

MG Times

MG WAVEFORM

ENVELOPE GENERATOR 1

EG1 Delay Time

EG1 Attack Time

EG1 Release Time

ENVELOPE GENERATOR 2

EG2 Hold Time

EG2 Attack Time

EG2 Decay Time

EG2 Sustain Level

EG2 Release Time

MIXER 1

Mixer 1 Level A

Mixer 1 Level B

MIXER 2

Mixer 2 Level A

Mixer 2 Level B

EXTERNAL SIGNAL PROCESSOR

ESP Signal Level

ESP Low Cut Freq

ESP High Cut Freq

ESP CV Adjust

ESP Threshold

EGs

The MS-20EX adds the following separate controls for EGs 3, 4, 5 and 6:

- Attack time (relative)
- Decay & Slope time (relative)
- Sustain level (relative)
- Release time (relative)

LFOs

In addition to supporting the standard Tone Adjust LFO parameters, the MS-20EX adds the following separate controls:

- LFO 1, 2, 3, and 4 Waveform
- LFO 1, 2, 3, and 4 Shape
- LFO 3 Speed (relative)
- LFO 3 Fade (relative)
- LFO 3 Delay (relative)
- LFO 3 Stop
- LFO 4 Speed (relative)
- LFO 4 Fade (relative)
- LFO 4 Delay (relative)
- LFO 4 Stop

EXi MS-20: Page Menu Commands

| | |
|------------------------|--------|
| Compare | →p.112 |
| Write Program | →p.112 |
| Exclusive Solo | →p.113 |
| Copy Envelope | →p.182 |
| Swap Envelope | →p.182 |
| Copy LFO | →p.182 |
| Swap LFO | →p.182 |
| Delete All Connections | →p.282 |
| PAGE | →p.126 |
| MODE | →p.126 |

Delete All Connections

This command removes all of the connections from the Patch Panel, so that you can start from a blank slate.

EXi: PolysixEX

PolysixEX Overview

The PolysixEX is a rich-sounding, easy-to-use, high-polyphony virtual analog synth (up to 180 voices!). It combines the features and sonic character of the classic Korg Polysix (and the Legacy Polysix plug-in) with many additional capabilities unique to the NAUTILUS. Features include:

- Korg’s proprietary CMT (Component Modeling Technology)
- Up to 180-voice polyphony
- Oscillator, sub-oscillator, and 4-pole resonant lowpass filter
- Dedicated chorus/ensemble/phaser effects
- Classic ADSR envelope, plus two multi-stage EGs
- Classic “MG” LFO, plus two multi-waveform LFOs
- Easy-to-use, sample-accurate arpeggiator
- Extensive AMS modulation, plus four AMS mixers

- Access to all standard EXi Program features, including the Common LFO, Common Step Sequencer, Key Track 1 & 2, Arpeggiator, EQ, and effects—as well as layering with any other EXi (including using two PolysixEXs together!)

PolysixEX uses EXi fixed resources

The PolysixEX uses EXi fixed resources for its built-in effects. These take up a small amount of processing power, even if you’re not playing any notes.

Because of this, you can use only 16 PolysixEXs simultaneously in a Combination or Song. If other EXis with fixed resources are in use, the maximum number of PolysixEXs will be reduced accordingly. Each EXi in each Program counts towards the maximum; for instance, a Program with two PolysixEXs counts as two, not as one.

For more information, see “CX-3 & other EXi: Limitations on EXi fixed resources” on page 380.

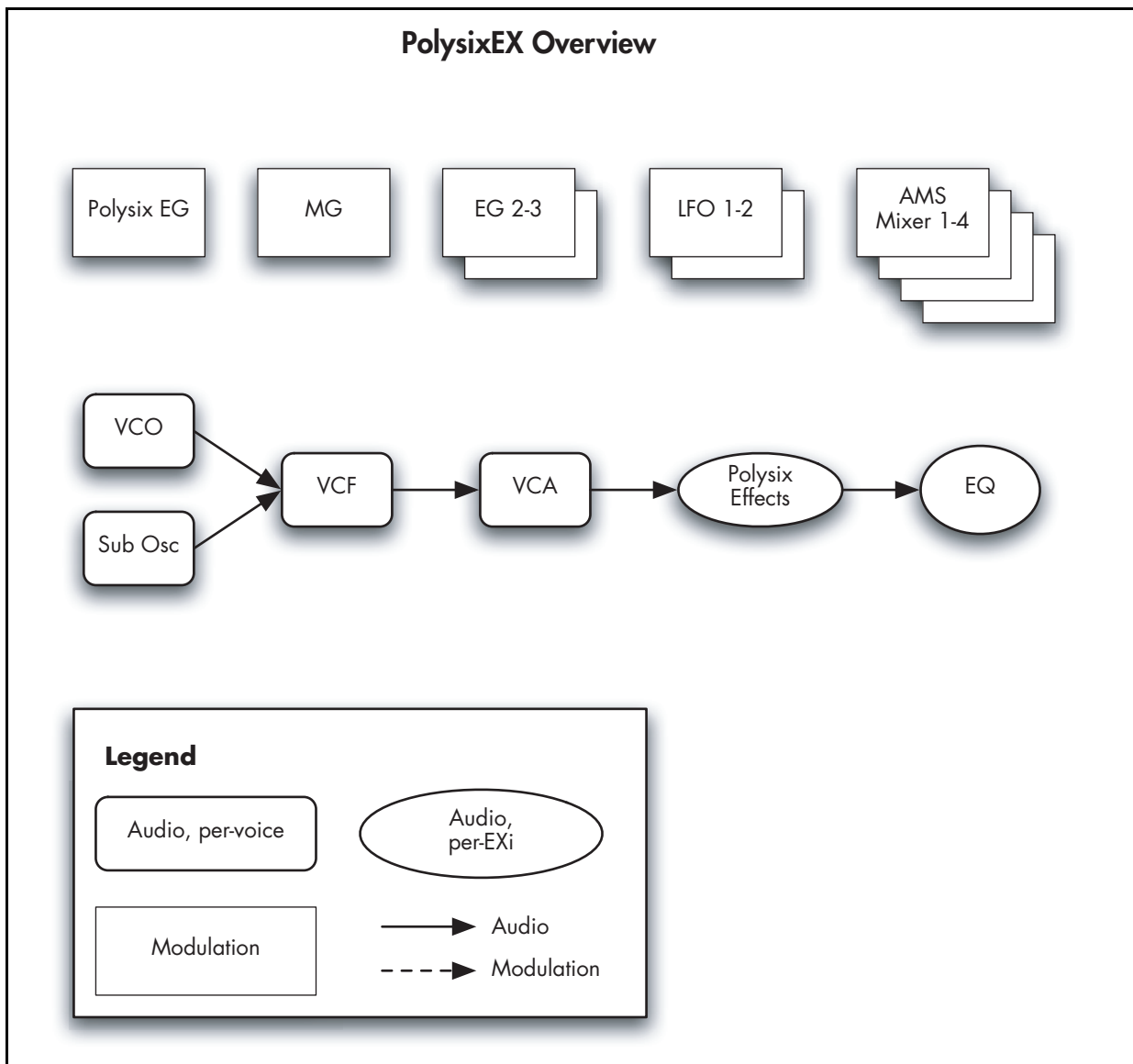

Unsupported EXi Common parameters

The PolysixEX supports all of the EXi Common parameters, except for two of the voice allocation options: **Poly Legato** and **Mono Mode** (Normal/Use Legato Offset).

All of the other voice allocation options are fully supported, including Mono, Mono Legato, Unison, etc.

On-screen knobs and switches and the Parameter Details area

Parameter Details

The LCD displays include graphic knobs and switches for all of the main PolysixEX parameters. These let you view and edit parameters quickly and easily. Almost all of the original Polysix parameters fit onto a single NAUTILUS page.

You can program any original Polysix sound using only these knobs and switches. If you want more flexibility and control, however, the PolysixEX offers two additional EGs and LFOs, four AMS mixers, access to the EXi Program's Common LFO, Common Step Sequencer, and AMS modulation for almost every original Polysix parameter.

The entry way to these advanced features is the Parameter Details area, located in the lower right-hand part of the display:

Parameter Details area

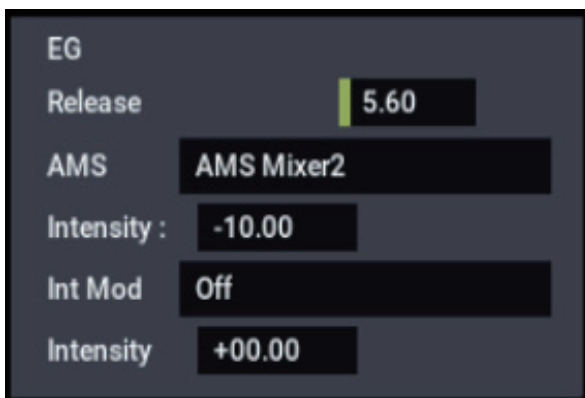

The Parameter Details area shows information for the selected knob or switch, including its parameter group and parameter name, its exact value, and its AMS assignments.

Using the graphic parameters

Editing knobs and sliding switches

To edit knobs and sliding switches, such as the three-position **MG MODE** switch:

1. **Touch the knob or switch.**

A yellow square will appear around the knob or switch, showing that it has been selected. The Parameter Details area will change to show the name and value of the current parameter, along with other related information.

2. **Touch and then drag the knob to change its value. You can use either up-down or right-left gestures.**

or:

Use any of the VALUE controllers to edit the value.

You can use the +/- buttons, or the VALUE dial.

As you edit the value, notice that the graphic knob or switch moves, and that the value in the Parameter Details area changes as well.

Editing on/off switches

To edit an on/off switch, such as the **MG KEY SYNC** button, simply:

1. **Touch the switch to toggle the value.**

Assigning AMS modulation

Most parameters support modulation via AMS. Sources and intensities can be edited in the Parameter Details area:

1. **Touch the knob or switch.**

If the parameter supports AMS modulation, the Parameter Details area will show one or more AMS sources and intensities.

2. **Edit the AMS settings in the Parameter Details area.**

Note: The graphic knobs and switches always show their stored value. Absolute Tone Adjust settings edit these values, just as if you were editing the parameters themselves, and so the graphics will show the results. However, AMS modulation does not edit the stored value, and so the graphics do not include the results of AMS.

Note also that AMS can often modulate parameters outside the range of the stored values, as if you were pushing the parameter beyond the ends of the knob.

Poly, Unison, Chord, and Hold

The original Polysix had four switches to select different voice-allocation options, including **POLY**, **UNISON** (mono), **CHORD**, and **HOLD**. In the NAUTILUS, all of these functions (and many more besides) are available on the Program Basic page.

EXi PROGRAM > PolysixEX: Home

0-1: Overview



This is the main page of PROGRAM mode. For a full description of this page and all of its functions, please see “EXi PROGRAM > Home” on page 127. This section describes only the overview display, which differs for each individual EXi.

0-1b: Overview and Page Jump

This part of the page shows an overview of the most important settings for the Program’s two EXi instruments. The specific parameters will vary, depending on which EXi are being used. The specific parameters for the PolysixEX are described below.

The graphics give you a quick way to check all of these settings at a glance. They also let you jump instantly to any of the displayed parameters. Just touch one of the sections, and you’ll jump to the page containing its parameters. For instance, if you touch the Filter graphic, you’ll go to the Oscillator and Filter page.

Tip: Pressing EXIT several times will always bring you back to this page.

VCO/VCF/EG/MG

This section shows the most important oscillator, filter, envelope, and modulation generator parameters. Touch this area to jump directly to the main PolysixEX page.

Arpeggiator

This section shows the arpeggiator parameters. Touch this area to jump directly to the Modulation & Arpeggiator page.

EGs and LFOs

EG 2,3 Graphics

These show the shapes of the two multi-stage EGs. Touch either of them to jump directly to the corresponding edit page.

LFO 1,2 Graphics

These show the waveforms and shapes of the two LFOs. Touch either of them to jump directly to the corresponding edit page.

Key Zone

Key Zone

This shows the key zones for EXi1 and EXi2, as set on the Common section’s Program Basic page, in relation to the entire MIDI note range. The range of the 61-, 73-, or 88-note keyboard is also shown, as appropriate.

Press this area to jump to the Program Basic page.

0-1d: Common

3Band EQ Graphic

| | |
|------------------------|-------------|
| Mute (1) | [On, Off] |
| Mute (2) | [On, Off] |
| Mute (DrumT) | [On, Off] |
| EXi1 Instrument Volume | [000...127] |
| EXi2 Instrument Volume | [000...127] |
| Drum Track Volume | [000...127] |

This is the same as with HD-1 programs. For more information, please see “0-1d: Common” on page 4.

✓ 0-1: Page Menu Commands

- Compare →p.112

- Write Program →p.112
- Exclusive Solo →p.113
- Show MS/WS/DKit Graphics →p.113
- Add To Set List →p.113
- Initialize Program →p.113

- PAGE →p.126
- MODE →p.126

PROGRAM > PolysixEX: Main

4-1: Patch Panel

**4-1a: VCO****VIBRATO INT** [0.00... 10.00]

Moving the joystick “up” from the center detent position, away from yourself, produces the JS+Y controller (MIDI CC#1). On the PolysixEX, JS+Y normally controls **VIBRATO**—the amount of the MG applied to VCO pitch.

VIBRATO INT controls the intensity of this modulation, up to +/- 2 semitones. To disable JS+Y’s control of **VIBRATO**, set this to **0.00**.

Note that this is optimized for fairly small amounts of pitch modulation. For more dramatic effects, set the MG’s **MODE** to **VCO**, and adjust the depth via the MG’s **LEVEL** knob.

Alternatively, you can modulate **TRANSPOSE** or **TUNE** via AMS.

MIDI **VIBRATO INT** is scaled by MIDI CC#77.

OCTAVE [16', 8', 4']

This sets the VCO’s coarse tuning, in octaves.

WAVEFORM [SAW, PW, PWM]

This selects the VCO’s waveform.

SAW produces a sawtooth wave—the traditional buzzy analog synth sound.

PW produces square and pulse waveforms; for more information, see “PW/PWM,” below.

PWM is similar to PW, but uses a dedicated LFO to modulate the waveform. The speed of the LFO is controlled by “PWM SPEED,” below. The **PW/PWM** setting determines the maximum width.

PW/PWM [0.00... 10.00]

When **WAVEFORM** is set to **PW**, this directly controls the shape of the waveform.

When **WAVEFORM** is set to **PWM**, this controls the maximum pulse width when being modulated by the dedicated PWM LFO. When **PW/PWM** is set to **0.00**, the LFO will have no effect.

More on Pulse Width

Pulse waveforms are simple, rectangular shapes. The Pulse Width sets the percentage of the waveform spent in the “up” position. A few examples are shown in the diagram below. Note that a square wave is just a pulse wave with **PW/PWM** set to **0.00**.

The width controls the timbre of the oscillator, from pure and hollow at **0.00** (a square wave) to thin and reedy at higher settings.

At the maximum setting of **10.00**, the Pulse wave will be very quiet, since the “pulse” goes up and then down again almost instantly.

The real magic of the pulse wave comes when you modulate the width, using either AMS or the dedicated PWM LFO. With AMS, try using a medium-speed triangle LFO, or a sweeping EG.

Pulse waveform at different widths

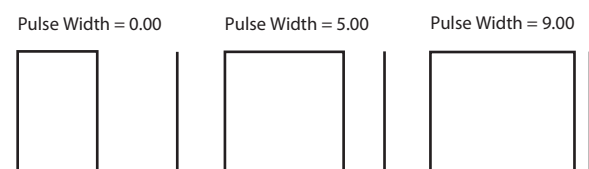

PWM SPEED [0.00...10.00]

The PolysixEX has an LFO dedicated to pulse width modulation (PWM). This adjusts the speed of that LFO. Note that this applies only when the **WAVEFORM** is set to **PWM**.

The dedicated PWM LFO is shared between all the PolysixEX voices, similar to the Common LFO.

If you'd like more flexible PWM, including per-voice modulation, you can use AMS to modulate the **PW/PWM** parameter directly.

SUB OSC [2OCT, 1OCT, OFF]

The VCO includes a sub-oscillator. You can set this to sound either one or two octaves below the main oscillator, or turn it off completely if desired.

2OCT: the sub-oscillator will sound at two octaves below the main oscillator.

1OCT: the sub-oscillator will sound at one octave below the main oscillator.

OFF: disables the sub-oscillator.

4-1b: MG (Modulation Generator) 

The MG is shared between all PolysixEX voices, similar to the Common LFO. For per-voice modulation, use **LFO1** or **2** instead.

The MG is available as an AMS source throughout the PolysixEX, in two different versions: **MG** is the unaltered MG signal, and **MG + Delay** is at 0 until the programmed **DELAY** time has elapsed.

TEMPO SYNC [Off, On]

Touch the text/LED area to turn **TEMPO SYNC** on and off.

On (LED lit): When **TEMPO SYNC** is **On**, the MG synchronizes to the system tempo, as set by either the tempo of program or MIDI Clock. The MG speed is controlled by the combination of the **BASE NOTE** and **FREQUENCY/TIMES** parameters, below.

Off (LED dark): When **TEMPO SYNC** is **Off**, the **FREQUENCY/TIMES** knob determines the speed of the MG, and the **BASE NOTE** setting has no effect.

This parameter is not modulatable via AMS.

KEY SYNC [Off, On]

If this setting is **ON**, the phase is reset for the first note-on in each legato phrase. Subsequent notes in a chord, or notes played legato, do not cause the phase to be reset.

This parameter is not modulatable via AMS.

BASE NOTE [1/1...1/32]

When **TEMPO SYNC** is **ON**, this sets the basic speed of the MG, relative to the system tempo. The values range from a 32nd note to a whole note, including triplets. This value is then multiplied by the **FREQUENCY/TIMES** knob, below.

When **TEMPO SYNC** is **OFF**, this parameter has no effect.

This parameter is not modulatable via AMS.

FREQUENCY/TIMES [0.00...10.00/16...1]

If **TEMPO SYNC** is **OFF**, this controls the frequency of the MG.

If **TEMPO SYNC** is **ON**, this multiplies the length of the **BASE NOTE**. For instance, if the **BASE NOTE** is set to a sixteenth note, and **Times** is set to 3, the MG will cycle over a dotted eighth note. Note that higher values mean a faster MG.

DELAY [0.00...10.00]

Adjusts the time from note-on until the MG is heard.

Note that this affects only the routing selected by the **MODE** parameter, below; the **VIBRATO** always uses the undelayed MG signal.

LEVEL [0.00...10.00]

Adjusts the depth of the effect produced by the MG.

MODE [VCA, VCF, VCO]

Selects whether the MG modulates the amplitude (**VCA**), the filter cutoff (**VCF**), or the pitch (**VCO**).

4-1c: VCF**CUTOFF** [0.00...10.00]

This controls the cutoff frequency of the 24dB lowpass filter. Sounds above this frequency are removed, making the timbre darker.

 This is scaled by MIDI CC#74.

RESONANCE [0.00...10.00]

Resonance emphasizes the frequencies around the cutoff frequency.

When this is set to **0**, there is no emphasis, and frequencies beyond the cutoff will simply diminish smoothly.

At medium settings, the resonance will alter the timbre of the filter, making it sound more nasal, or more extreme.

At very high settings, the resonance can be heard as a separate, whistling pitch. Near the maximum setting, the filter will self-oscillate.

 **RESONANCE** is scaled by MIDI CC#7.

EG INTENSITY [-5.00...+5.00]

Specifies the depth and direction to which the EG will affect the cutoff frequency.

 This is scaled by MIDI CC#79.

KBD TRACK [0.0...150.0]

Adjusts the depth to which the cutoff frequency will change according to the note number, centered at C3.

With a setting of 100, the change in cutoff frequency will be proportionate to the change in pitch (1 octave in pitch = 1 octave in filter frequency).

Note: Unlike some of the other EXi, the PolysixEX keyboard tracking does not include the effects of pitch bend. This matches the behavior of the original synthesizer. If desired, you can create the same effect by using JS X as an AMS source for the **VCF CUTOFF**.

4-1d: EG

EG

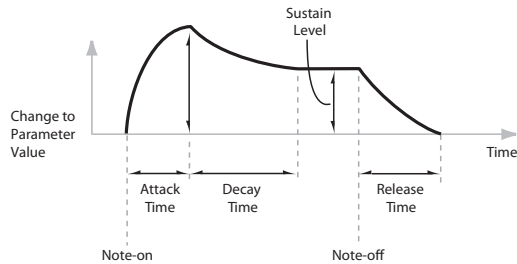
**ATTACK** [0.00...10.00]

Adjusts the time from note-on until the maximum level is reached.

MIDI This is scaled by MIDI CC# 73.

DECAY [0.00...10.00]

Adjusts the time the EG takes to descend from the peak to the sustain level.

MIDI This is scaled by MIDI CC# 75.

SUSTAIN [0.00...10.00]

Adjusts the sustain level. The EG will stay at this level until the note is released.

MIDI This is scaled by MIDI CC# 70.

RELEASE [0.00...10.00]

Adjusts the time from the note-off until the level decays to zero.

MIDI This is scaled by MIDI CC# 72.

Using separate EGs for the VCF and VCA

Unlike the original Polysix, the PolysixEX lets you use separate EGs for the VCF and the VCA. To do so:

1. Set the **VCA MODE** switch to **EG**.
2. Set the **VCF EG INTENSITY** to **0.00**.
3. Select the **CUTOFF** parameter.
4. In the **Parameter Details** panel for **CUTOFF**, select **EG2** as the **AMS source**.
5. Set the **AMS Intensity** as desired.

Now, the original EG will control the VCA, and EG2 will control the VCF.

4-1e: VCA

VCA stands for Voltage Controlled Amplifier, which is the circuit that controls the volume of an analog synthesizer.

MODE [EG, Gate]

This selects the main control source for the volume.

EG means that the volume is controlled by the ADSR envelope.

You can also use EGs 2 or 3 to modulate the main **VOLUME** parameter via AMS.

Gate means that the volume goes to maximum immediately at note-on, and falls to silence immediately at note-off.

ATTENUATOR [-20.0...+20.0dB]

Adjusts the volume up or down by 20dB, in 0.1 dB increments. This is separate from the main **VOLUME** knob, below.

Also, unlike **VOLUME**, the **ATTENUATOR** is per-voice, which means that you can modulate it via per-voice AMS sources such as EGs, LFOs 1 and 2, key tracking, etc.

4-1f: OUTPUT**PAN** [Random, L001...C064...R127]

This controls the stereo pan of the PolysixEX, at the very end of the signal chain. A setting of **L001** places the sound at the far left, **C064** in the center, and **R127** to the far right.

When this is set to **Random**, the pan position will be different for each note-on.

MIDI You can also control pan via MIDI Pan (CC#10). A CC#10 value of 0 or 1 places the sound at the far left, 64 places the sound at the location specified by the "Pan" parameter, and 127 places the sound at the far right. This is controlled on the global MIDI channel (GLOBAL 1-1a).

Note: You can select Random pan only from the on-screen UI, and not from AMS, MIDI.

Note that this is a post-effects pan, while **Unison Stereo Spread** is pre-effects:

Pan via **Unison Stereo Spread** -> PolysixEX Effects (stereo) -> **PAN** knob (stereo in-out)

In the PolysixEX, **PAN** affects all voices at once, and so it cannot be modulated by per-voice AMS sources such as EGs or LFOs 1 and 2.

VOLUME [0.00...10.00]

This controls the main output level. It affects all voices at once, and so it cannot be modulated by per-voice AMS sources such as EGs or LFOs 1 and 2.

For per-voice modulation, use the **ATTENUATOR** parameter instead. For more information, see "ATTENUATOR" on page 289.

4-1g: PITCH**BEND RANGE** [0.00...12.00]

This sets the maximum amount of pitch bend up and down, in semitones and cents, as controlled by JS X. To use another AMS source for pitch bend, modulate the **TRANSPOSE** or **TUNE** parameters instead.

BEND RANGE is not modulatable via AMS.

TRANSPOSE [-24.00...+24.00]

This controls the coarse tuning, in half-steps and cents, up or down two octaves. You can modulate this smoothly via AMS.

TUNE [-5.00...+5.00]

This adjusts the pitch of the oscillators, in steps of 1/5 of a cent, for a total range of +/- 1 semitone.

4-1h: EFFECTS

MODE [OFF, CHORUS, PHASE, ENSEMBLE]

Switches the effect mode. Choose from chorus, phase, and ensemble.

SPREAD [0.00...10.00]

Adjusts the width to which the effect sound will be panned.

SPEED/INTENSITY [0.00...10.00]

Adjusts the speed or intensity of the effect.

If **MODE** is set to **Chorus** or **Phase**, this adjusts the speed. If **Ensemble** is selected, this adjusts the depth.

4-1i: Parameter Details

When you touch a knob or switch, a yellow square appears around it, showing that it has been selected.

The Parameter Details area shows information for this selected item, including its parameter group and parameter name, its exact value, and its AMS assignments.

Individual parameters and AMS

PITCH BEND RANGE is not modulatable via AMS. The **PAN** knob and a number of switches are modulatable by a single AMS source, as described under “Pan knob and Buttons,” below. The rest of the continuous knobs on this page are modulatable via two AMS sources, as detailed under “Knobs,” below.

(Parameter group)

This shows the group of the parameter (such as **VCO**).

(Parameter name) [range depends on parameter]

This shows the name and exact value of the parameter. You can edit the parameter value with any of the standard data-entry controls.

Knobs**AMS** [List of AMS Sources]

This selects a modulation source to control the selected parameter. For a list of AMS sources, see “Alternate Modulation Source (AMS) List” on page 903.

Intensity [range depends on parameter]

This controls the depth and direction of the AMS modulation. For unipolar parameters, the range is the same as that of the selected parameter, in both positive and negative directions. For instance, if the parameter range is 0.00...10.00, the Intensity range will be -10.00...+10.00.

For bipolar parameters, including **FILTER EG INTENSITY**, **VCA ATTENUATOR**, **TRANSDOUBLE**, and **TUNE**, the range is twice that of the original parameter. For instance, if the original parameter range is -24.00...+24.00, the Intensity range will be double that: -48.00...+48.00. This allows full modulation of the parameter, regardless of the initial setting.

In some cases, you can use this to modulate the parameter outside of its original range, for a wider range of values.

Int Mod [List of AMS Sources]

You can modulate the main AMS Intensity from another AMS source. This selects that source. For a list of AMS sources, see “Alternate Modulation Source (AMS) List” on page 903.

Intensity [range depends on parameter]

This controls the depth and direction of the Intensity Mod. The result is summed with the main AMS Intensity to produce the final modulation amount.

Pan knob and Buttons

The **PAN** knob and the **OCTAVE**, **WAVEFORM**, **SUB OSC**, **VCA MODE**, **MG MODE**, and **EFFECTS MODE** switches can each be modulated from a single AMS source.

TEMPO SYNC, **KEY SYNC**, and **BASE NOTE** are not modulatable.

AMS [List of AMS Sources]

This selects a modulation source to control the selected parameter. For a list of AMS sources, see “Alternate Modulation Source (AMS) List” on page 903.

Intensity [range depends on parameter]

This controls the depth and direction of the AMS modulation. The range is the same as the selected parameter, in both positive and negative directions.

✓ 4-1: Page Menu Commands

- Compare →p.112
- Write Program →p.112
- Exclusive Solo →p.113
- PAGE →p.126
- MODE →p.126

PROGRAM > PolysixEX: Modulation & Arpeggiator

5-1: Mod & Arp



5-1a: EXTERNAL MODULATION

The External Modulation section offers an easy way to assign modulation to multiple destinations at once, using any AMS source. Note that most parameters also include dedicated AMS modulation, via the Parameter Details area.

Source 1**SOURCE 1** [List of AMS Sources]

This selects the modulation source to control the parameters below. For a list of AMS sources, see “Alternate Modulation Source (AMS) List” on page 903.

VCO PULSE WIDTH [-10.00...+10.00]

Specifies the depth and direction of the modulation applied to the oscillator (VCO) PW/PWM.

VCF CUTOFF [-10.00...+10.00]

Specifies the depth and direction of the modulation applied to the filter (VCF) CUTOFF.

VCA GAIN [-10.00...+10.00]

Specifies the depth and direction of the modulation applied to the amp (VCA).

MG LEVEL [-10.00...+10.00]

Specifies the depth and direction of the modulation applied to the MG (Modulation Generator) LEVEL.

Source 2

This allows you to route a second AMS source to the same list of mod destinations. The parameters are identical to those under “Source 1,” above.

5-1b: ARPEGGIATOR

ON/OFF [Off, On]

Switches the arpeggiator on/off.

KEY SYNC [Off, On]

If this setting is **ON**, the arpeggiator will be reset at the beginning of each legato phrase.

This parameter is not modulatable.

TEMPO SYNC [Off, On]

Touch the text/LED area to turn **TEMPO SYNC** on and off.

On (LED lit): When **TEMPO SYNC** is **On**, the arpeggiator synchronizes to the system tempo, as set by either the Tempo or MIDI Clock. The arpeggiator speed is controlled by the combination of the **BASE NOTE** and **SPEED/TIMES** parameters, below.

Off (LED dark): When **TEMPO SYNC** is **Off**, the **FREQUENCY/TIMES** knob determines the speed of the arpeggiator, and the **BASE NOTE** setting has no effect.

This parameter is not modulatable via AMS.

BASE NOTE [1/1...1/32]

When **TEMPO SYNC** is **ON**, this sets the basic speed of the arpeggiator, relative to the system tempo. The values range from a 32nd note to a whole note, including triplets. This value is then multiplied by the **SPEED/TIMES** knob, below.

When **TEMPO SYNC** is **OFF**, this parameter has no effect.

BASE NOTE is not modulatable via AMS.

SPEED/TIMES [0.00...10.00/16...1]

If **TEMPO SYNC** is **OFF**, this controls the speed of the arpeggiator.

If **TEMPO SYNC** is **ON**, this multiplies the length of the **BASE NOTE**. For instance, if the **BASE NOTE** is set to a sixteenth note, and Times is set to 3, each arpeggiator step will last for a dotted eighth note. Note that higher values mean a faster arpeggio.

RANGE [1OCT, 2OCT, FULL]

Specifies the range in which the arpeggiator will play the pattern. **FULL** plays the pattern over 6 octaves.

MODE [UP/DOWN, DOWN, UP]

Selects the pattern that the arpeggiator will play.

LATCH [Off, On]

Specifies whether the arpeggiator will continue playing even after note-off occurs.

5-1c: ANALOG**ANALOG** [0.00...10.00]

This models the instability of an analog system by adding subtle randomization to the VCO and VCF frequencies.

This parameter is not modulatable.

5-1d: Parameter Details

This area shows details for the selected knob, including its parameter group and parameter name, its exact value, and its AMS assignments.

Individual parameters and AMS

Only the **ARPEGGIATOR** parameters are modulatable via AMS; the **EXTERNAL MODULATION** and **ANALOG** knobs, the **BASE NOTE** parameter, and the **TEMPO SYNC** and **KEY SYNC** switches are not modulatable.

Note that the **ARPEGGIATOR** affects all voices at once, and so it cannot be modulated by per-voice AMS sources such as EGs or LFOs 1 and 2.

(Parameter group)

This shows the group of the parameter (such as **ARPEGGIATOR**).

(Parameter name) [range depends on parameter]

This shows the name and exact value of the parameter. You can edit the parameter value with any of the standard data-entry controls.

SPEED/TIMES knob**AMS** [List of AMS Sources]

This selects the first modulation source to control the selected parameter. For a list of AMS sources, see “Alternate Modulation Source (AMS) List” on page 903.

Intensity [range depends on parameter]

This controls the depth and direction of the AMS modulation. The range is the same as the selected parameter, in both positive and negative directions. For instance, if the parameter range is 0.00...10.00, the Intensity range will be -10.00...+10.00.

Int Mod [List of AMS Sources]

You can modulate the main AMS Intensity from another AMS source. This selects that source.

For a list of AMS sources, see “Alternate Modulation Source (AMS) List” on page 903.

Intensity [range depends on parameter]

This controls the depth and direction of the Intensity Mod. The result is summed with the main AMS Intensity to produce the final modulation amount.

Multi-position Switches

Multi-position switch parameters, including **RANGE** and **MODE**, have only a single AMS/Intensity pair, as below.

AMS [List of AMS Sources]

This selects a modulation source to control the selected parameter. For a list of AMS sources, see “Alternate Modulation Source (AMS) List” on page 903.

Intensity [range depends on parameter]

This controls the depth and direction of the AMS modulation. The range is the same as the selected parameter, in both positive and negative directions.

On/Off Switches

On/off switch parameters, including **ARPEGGIATOR ON/OFF** and **LATCH**, have only a single AMS/Intensity pair, as below.

AMS [List of AMS Sources]

This selects a modulation source to control the selected parameter. For a list of AMS sources, see “Alternate Modulation Source (AMS) List” on page 903.

AMS Mode [Toggle, Momentary]

This parameter controls the way in which the switch AMS works.

When this is set to **Toggle**, the switch will alternate between on and off. For instance, if **LATCH** is set to **Off**, and **AMS** is assigned to a footswitch, the first press will cause the arpeggiator latch to turn on, and the next press will turn it off again.

Momentary means that the switch value is changed only while the controller is enabled. Continuing the example from above, when the footswitch is pressed down, the arpeggiator latch will turn on; when the footswitch is released, the latch will turn it off again.

AMS lets you switch to the opposite of the programmed setting. For instance, if **LATCH** is set to **On**, and the **AMS Mode** is set to **Momentary**, then pressing down on the footswitch would cause the latch to turn off.

If you set AMS to use a continuous controller, such as the Joystick, values of 0-63 are as if the switch was off, and values of 64-127 are as if the switch was on.

Finally - note that the assignable switches, **SW1** and **SW2**, can themselves be set to either momentary or toggle modes, and these settings are reflected by the switch LEDs. Individual parameter mode settings, such as the **LATCH AMS Mode**, do *not* affect the LEDs.

So, if you're using **SW1** or **SW2** as the AMS source, it's best to set the AMS Mode to Momentary, and then just let the switch itself determine the momentary/toggle behavior.

✓ 5-1: Page Menu Commands

- Compare →p.112
 - Write Program →p.112
 - Exclusive Solo →p.113
 - PAGE →p.126
 - MODE →p.126
-

PROGRAM > PolysixEX: EG

The PolysixEX has two assignable EGs, in addition to the original EG. Each of these can be used as an AMS modulation source to control a wide variety of parameters.

7-1: EG 2 AMSource

7-2: EG 3 AMSource

The PolysixEX's EGs 2 and 3 are identical to the AL-1's EG1. For detailed explanations, please see "7-1: EG 1 (Filter)," on page 169.

PROGRAM > PolysixEX: LFO

The PolysixEX has two assignable LFOs, in addition to the original Polysix MG and the EXi Program's Common LFO. Each of these can be used as an AMS modulation source to control a wide variety of parameters.

8-1: LFO 1 AMSource

8-2: LFO 2 AMSource

The PolysixEX's LFOs 1 and 2 are identical to those of the AL-1. For detailed explanations, please see "8-2: LFO 1," on page 175.

PROGRAM > PolysixEX: AMS Mixers

The AMS mixer lets you combine two AMS sources into one, or process an AMS source to make it into something new.

For instance, you can multiply two AMS sources, or use a single AMS source to change the source settings of another source. You can also change the LFOs and EGs in varied ways, or control the response of the real-time controls.

The AMS mixer outputs appear in the list of AMS sources, just as with the LFOs and EGs.

This also means that the AMS configured with the AMS mixer input can itself be reused as an AMS. For instance, if you use LFO1 as an input for an AMS mixer, you can use the processed version of the LFO signal to control one AMS modulation, and the original version of the LFO signal to control another AMS modulation.

AMS mixers can also be used in cascading sequence. For example, you can use AMS Mixer 1 as the input for AMS Mixer 2.

9-1: AMS Mixers 1/2 AMSource

9-2: AMS Mixers 3/4 AMSource

The PolysixEX's AMS Mixers are identical to those of the AL-1 (although the PolysixEX has four, to the AL-1's two). For detailed explanations, please see "9-1: AMS Mixer," on page 179.

PolysixEX: Tone Adjust

PolysixEX Tone Adjust Default Settings

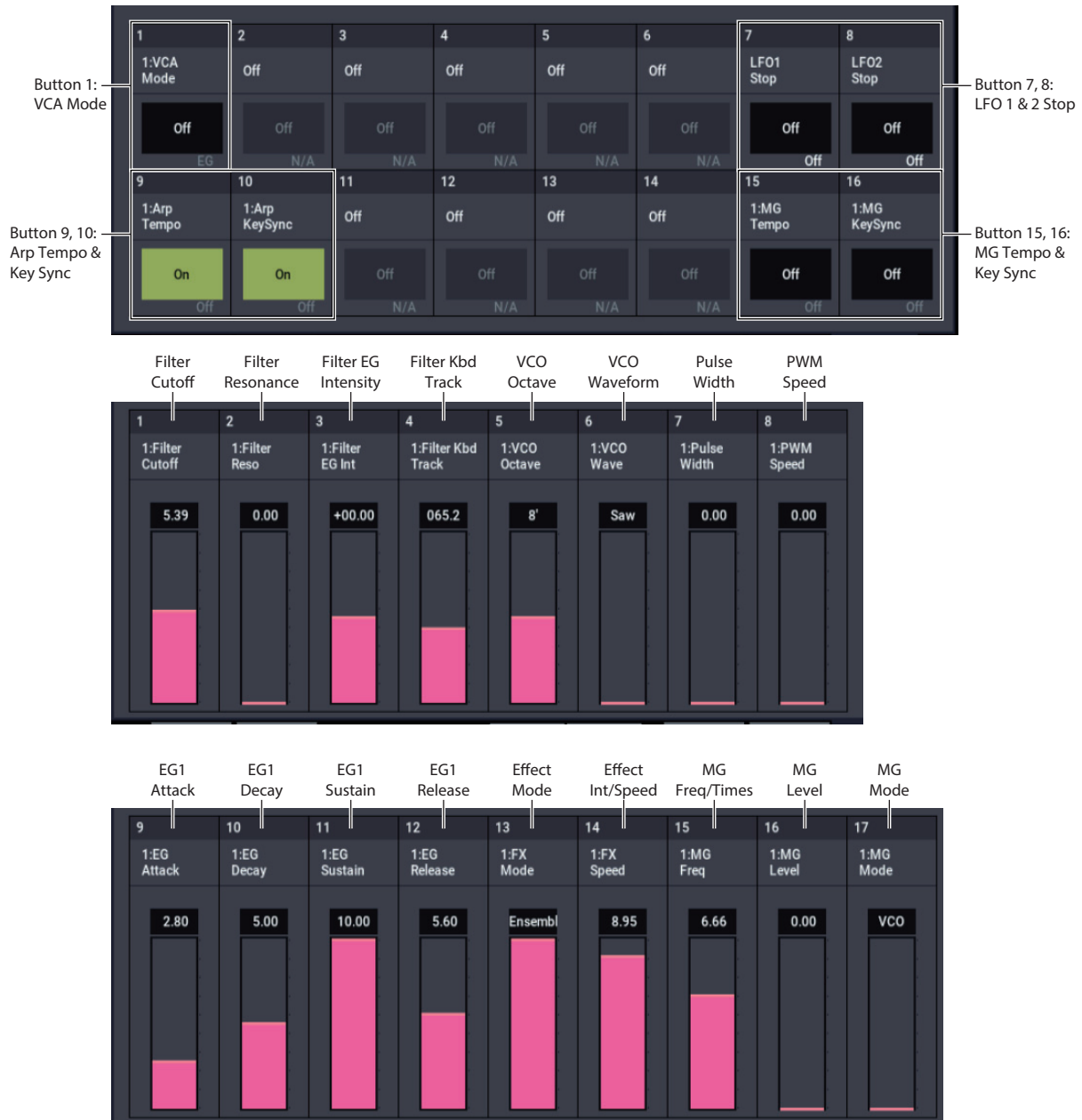

Tone Adjust provides an elegant physical interface to the PolysixEX’s parameters. Most of the factory sounds use the default layout, as shown above. You can also customize the layout for individual sounds, if desired.

For more information about Tone Adjust, please see “0–9a: Tone Adjust,” on page 29.

Common Tone Adjust parameters

These parameters affect both EXi 1 and 2. Except as noted below, the Common Tone Adjust parameters behave as described under “Common Tone Adjust Parameters,” on page 31.

Amp Velocity Intensity. (–99...+99)
Not supported.

Filter/Amp EG Attack Time.
(–99...+99, CC#73)
This scales the attack time of the PolysixEX EG. It interacts with CC# 73.

Filter/Amp EG Decay Time.
(–99...+99, CC#75)
This scales the decay time of the PolysixEX EG. It interacts with CC# 75.

Filter/Amp EG Sustain Level.
(–99...+99, CC#70)
This scales the sustain level of the PolysixEX EG. It interacts with CC# 70.

Filter/Amp EG Release Time.
(–99...+99, CC#72)
This scales the release time of the PolysixEX EG. It interacts with CC# 72.

Filter EG, Amp EG, and Pitch EG Attack Time, Decay Time, Sustain Level, Release Time are not supported by the PolysixEX.

Pitch LFO1 Intensity. (-99...+99, CC#77)
This scales the **VIBRATO INT** parameter.

PolysixEX Tone Adjust parameters

In addition to the Common Tone Adjust parameters listed above, the PolysixEX adds a number of its own parameters.

Note that these additional parameters are separate for each EXi, as opposed to being shared by both EXi in the Program.

All of the additional parameters are listed below. Tone Adjust parameters may affect the internal parameters in one of two ways: they may be **Relative**, in which case they scale the existing parameter value, or **Absolute**, in which case they over-write the existing value. Unless otherwise noted, all of the PolysixEX parameters are **Absolute**.

VCO

Vibrato Int
Vibrato Int AMS Int
VCO Octave
VCO Waveform
PW/PWM
PW/PWM AMS Int
PWM Speed
PWM Speed AMS Int
Sub Osc
Sub Osc AMS Int

VCF

Filter Cutoff
Filter Cutoff AMS Int
Filter Resonance
Filter Resonance AMS Int
Filter EG Intensity
Filter EG Intensity AMS Int
Filter Keyboard Track

VCA

VCA Mode
Attenuator
Attenuator AMS Int

EG

EG Attack Time
EG Attack Time AMS Int
EG Decay Time
EG Decay Time AMS Int
Sustain Level
Sustain Level AMS Int
Release Time
Release Time AMS Int

OUTPUT

Volume
Volume AMS Int

MODULATION GENERATOR (MG)

MG Key Sync
MG Tempo Sync
MG Base Note
MG Frequency
MG Frequency AMS Int
MG Sync Times
MG Sync Times AMS Int
MG Delay
MG Level
MG Level AMS Int
MG Mode

PITCH

Transpose
Transpose AMS Int
Tune
Tune AMS Int

EFFECTS

Effect Mode
Effect Spread
Effect Spread AMS Int
Effect Speed/Intensity
Effect Speed AMS Int

ARPEGGIATOR

Arpeg On/off
Arpeg Key Sync
Arpeg Tempo Sync
Arpeg Base Note
Arpeg Speed
Arpeg Speed AMS Int
Arpeg Times
Arpeg Times AMS Int
Arpeg Range
Arpeg Mode
Arpeg Latch

EGs

The following controls are available for both EG2 and EG3:

- Attack time (relative)
- Decay & Slope time (relative)
- Sustain level (relative)
- Release time (relative)

LFOs

In addition to supporting the standard Tone Adjust LFO parameters, the PolysixEX adds the following separate controls:

- LFO 1 and 2 Waveform
- LFO 1 and 2 Shape

EXi PolysixEX: Page Menu Commands

| | |
|----------------|--------|
| Compare | →p.112 |
| Write Program | →p.112 |
| Exclusive Solo | →p.113 |
| Copy Envelope | →p.182 |
| Swap Envelope | →p.182 |
| Copy LFO | →p.182 |
| Swap LFO | →p.182 |
| PAGE | →p.126 |
| MODE | →p.126 |

EXi: MOD-7 Waveshaping VPM Synthesizer

MOD-7 Overview

The MOD-7 is a powerful, semi-modular synthesizer, combining Variable Phase Modulation (VPM), waveshaping, ring modulation, PCM sample playback, and subtractive synthesis. Exceptionally versatile, the MOD-7 produces everything from classic FM keyboards and bells to rhythmic soundscapes, from cut-through-the-mix synth basses to sparkling, epic pads.

VPM refers to Korg's patented contributions to Frequency Modulation (FM) synthesis; for more information, see "VPM and FM Synthesis" on page 301.

Features include:

- Six VPM Oscillators. Each can be used as a sine, saw, triangle, square, or waveshaping oscillator with FM and ring modulation, or as a waveshaping and/or ring mod processor for other signals.
- 101 different waveshaping tables, whose response can be controlled via modulatable drive and offset.
- A PCM sample playback oscillator using Korg's ultra-low-aliasing PCM technology, as first introduced in the HD-1. This supports four-way velocity-switching between any mono samples from ROM, EXs, SAMPLING mode, or User Sample Banks.
- Dual multi-mode resonant filters (including Korg's Multi Filter, as first introduced in the AL-1).
- Three patchable, modulatable 2-in, 1-out mixers for combining and scaling audio signals.
- Noise generator with dedicated filter and saturation.
- Live audio input.
- Patch Panel allows free connection of all components, including the six VPM Oscillators, PCM oscillator, noise generator, real-time audio input, three modulatable mixers, and two filters. Connections can include multiple cables from a single output, hybrid serial/parallel routings, and feedback paths.
- "Vast" sample-mangling capabilities, with incredible flexibility and power. Use samples as FM modulators, and create incredibly rich processing environments combining multiple stages of filtering, waveshaping, and ring modulation, patched together however you'd like.
- Up to 52 voices of polyphony.
- Import classic FM sounds from the DX7.
- Four per-voice LFOs, ten re-triggerable EGs, nine key-tracking generators, eight AMS mixers, and a per-voice step sequencer.
- Access to all standard EXi Program features, including the Common LFO, Common Step Sequencer, Key Track 1 & 2, Arpeggiator, EQ, and effects—as well as layering with any other EXi (including two MOD-7s together, for 12 VPM oscillators!)

MOD-7 uses EXi fixed resources

The MOD-7 uses EXi fixed resources for its audio input. This takes up a very small amount of processing power, even if you're not playing any notes on the keyboard. The amount is tiny—around 1/96 that of the CX-3—but if other EXi are using large amounts of fixed resources, the number of MOD-7 that you can load in a Combination or Song may be limited.

Each EXi in each Program counts towards the maximum; for instance, a Program with two MOD-7s counts as two, not as one.

For more information, see "CX-3 & other EXi: Limitations on EXi fixed resources" on page 380.

Unsupported EXi Common parameters

The MOD-7 supports all of the EXi Common parameters, except for two of the voice allocation options: **Poly Legato** and **Mono Mode** (Normal/Use Legato Offset).

All of the other voice allocation options are fully supported, including Mono, Mono Legato, Unison, etc.

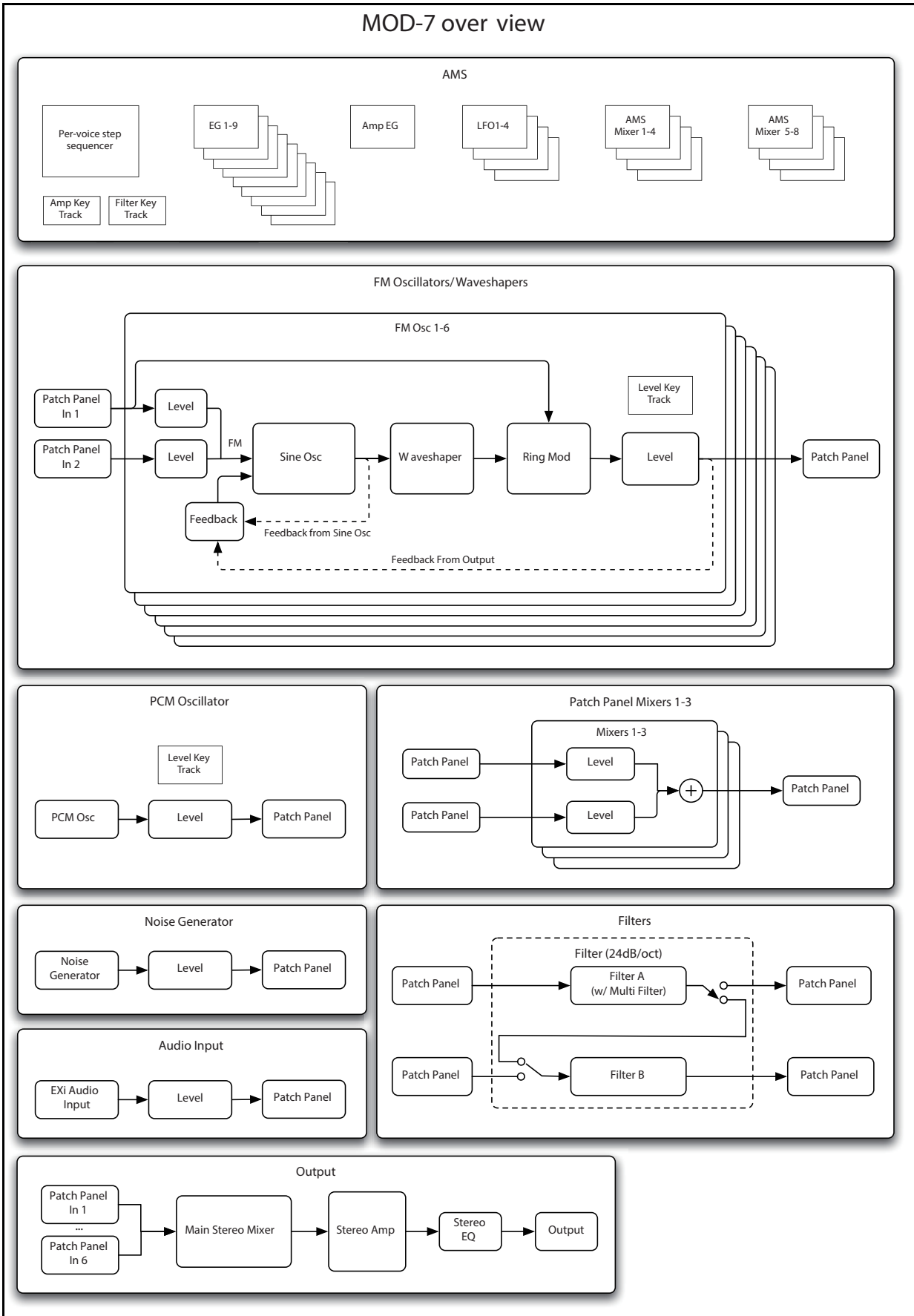

Using the Parameter Details area

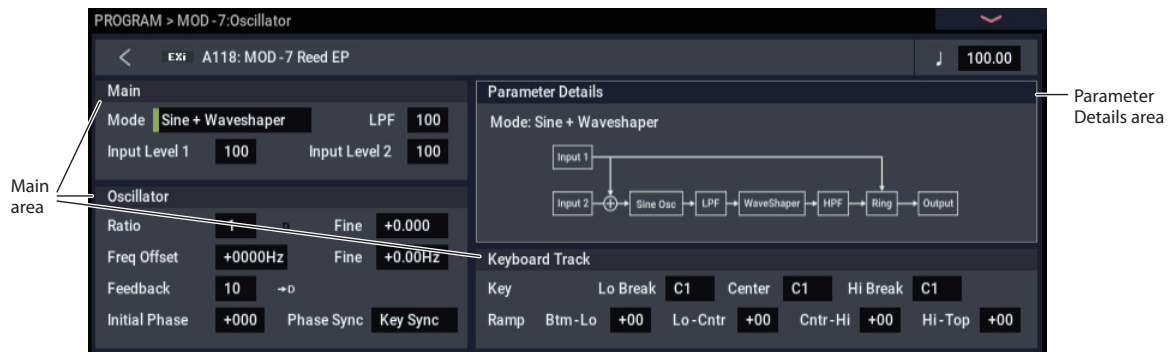

Overview

The LCD displays are divided into two sections. The first is the main part of the display, which includes all of the major MOD-7 parameters. This provides quick access to different functions, and an easy-to-read overview of the current settings.

The other section is the Parameter Details area, located in the upper right-hand part of the screen. This area shows information for the selected parameter, such as descriptive graphics and AMS assignments.

Assigning AMS modulation

Parameters which have AMS modulation shown only in the Parameter Details area are marked with either a black “D” or a white “D” (for “Details”) and an arrow. The black “D” indicates that the Parameter Details area includes the possibility of AMS modulation, but that none is assigned; the white “D” and arrow show that an AMS source is already assigned.

To edit AMS settings in the Parameter Details area:

- 1. Touch the parameter in the main area of the display.**

If the parameter supports AMS modulation, the Parameter Details area will show one or more AMS sources and intensities.

- 2. Edit the AMS settings in the Parameter Details area.**

Note that AMS can often modulate parameters outside the range of the stored values, as if you were pushing the parameter beyond the ends of the knob.

Loading DX sounds

Overview

The MOD-7 can load sounds created for the vintage DX7. There are thousands of these sounds available on the internet, providing a massive pre-existing library of timbres (in addition to the many sounds created exclusively for the MOD-7!). Try searching for “DX7 SysEx download.”

Once loaded, you can bring these vintage sounds up to date using all of the MOD-7’s unique features, layer them with other EXi, and process them with Arpeggiator and the NAUTILUS effects.

The conversion works by reading .SYX format System Exclusive files. This format is supported by programs on all major computer operating systems.

Supported file types

In order to load a file, it must meet the following requirements:

- The file must contain a complete bank of 32 DX7 sounds. Files with only a single sound cannot be loaded.
- The file may contain multiple System Exclusive messages, but only if the main DX7 bank dump is the first of these messages. All subsequent messages in the file will be ignored.

Note: Some instruments, such as the DX7II, may transmit multiple System Exclusive messages when doing their program data dump, with the main DX7 bank dump coming last. If this set of messages is stored into a single .SYX file, the NAUTILUS will not be able to load the file.

- The System Exclusive must be in the original, first-generation DX7 format, which was supported by all of the classic 6-operator FM synths as well as the DX9. System Exclusive files from later-generation FM instruments, such as 4-operator “baby DX” synths and the TX81Z, SY77, etc., cannot be loaded.

Loading a single bank of DX7 sounds

To load a bank of DX7 sounds:

1. **Transfer the DX7 .SYX file to NAUTILUS-readable media, such as a USB flash drive.**
2. **Connect the media to the NAUTILUS.**
3. **Press the front-panel MODE button to select MEDIA mode.**
4. **Go to the Load page.**
5. **In the Drive Select parameter, select the media from step 2, above.**
6. **Select the DX7 SYX file.**
7. **Press the LOAD button.**

A dialog box will appear, allowing you to select a bank into which to load the sounds. Since DX7 banks contain 32 sounds, while a NAUTILUS bank contains 128, you can also select where to place the DX7 sounds within the NAUTILUS bank: into Programs 0-31, 32-63, 64-95, or 96-127.

8. **Select the bank and Program range into which to load the sounds.**

Important: If you select an HD-1 bank, it will be changed to an EXi bank, and all of the bank’s HD-1 Programs will be erased.

9. **Press OK to load the sounds.**

The sounds will be loaded into the NAUTILUS as MOD-7 Programs.

Loading multiple banks of DX7 sounds

If you like, you can load multiple .SYX files at once. To do so:

1. **Follow steps 1 through 4 under “Loading a single bank of DX7 sounds,” above.**
2. **Enable the Multiple Select check-box.**
3. **Select the desired DX7 .SYX files.**
4. **Press the LOAD button.**

An “Are you sure?” dialog will appear.

5. **Press OK.**
6. **For each .SYX file, select the bank and Program range to load into.**

For more information, see steps 8 and 9 under “Loading a single bank of DX7 sounds,” above.

Error messages

If the NAUTILUS can’t read the file, it will show one of two error messages:

There is no readable data will appear if the file is shorter than 4104 bytes, or if the SysEx header indicates something other than DX7 Program Bank format.

File contains unsupported data will appear if the header is correct, but the data is damaged; for instance, if the file’s checksum doesn’t match, or if the trailing F7 is missing.

Synthesis with the MOD-7: a guided tour

Overview

The tutorials below provide a guided tour of the MOD-7's synthesis capabilities. They start with a little background information, and then dive right into step-by-step instructions for creating simple sounds from scratch, using all of the MOD-7's major features.

Please read each section in order, since the later ones rely on what you've done earlier.

VPM and FM Synthesis

Variable Phase Modulation (VPM) synthesis refers to Korg's patented contributions to Frequency Modulation (FM) synthesis.

Carrier-modulator pairs

In its most basic form, these synthesis methods use a pair of oscillators: a modulator and a carrier. Only the carrier is connected to the audio output. The modulator is not heard directly; instead, its output modulates the frequency (or phase) of the carrier.

This modulation creates changes in timbre. The relative frequencies (or "ratios") of the two oscillators determines which overtones are produced, and the level of the modulator controls the loudness of those overtones.

In general, whole-number ratios produce harmonically related overtones, fine deviations from whole-number ratios produce similar overtones with chorusing, and more complex ratios produce wild, clangorous overtones.

Greater complexity

Most modern VPM and FM synths allow more than simple oscillator pairs. For instance, a modulator might itself be modulated, to create a more complex timbre; two modulators might have separate paths into a single carrier; a single modulator might be sent to two or more carriers; and so on. A carrier might both be heard directly, and also act as a modulator on another oscillator. Feedback paths may let a carrier modulate itself.

In the MOD-7, these routings are created on the Patch Panel, by selecting an algorithm, creating patch cables, or a combination of the two.

The more complex the routing and frequency relationships, the more difficult it can be for even experienced sound designers to predict the results. As legend has it, the main breakthrough for FM itself came from a mistake, when FM pioneer John Chowning programmed an LFO with a frequency 100 times faster than he'd intended. When working with the MOD-7, take a cue from his example: keep experimenting, and leave your ears open for "happy accidents."

VPM, PCM, Waveshaping, and Ring Mod

The MOD-7 combines VPM with PCM sample playback, waveshaping, ring modulation, and dual multimode resonant filters. It's a powerful digital synthesis toolkit, and it can be approached from many different angles, as discussed in the tutorials below.

Aliasing

Multiplying one audio-rate signal with another generally causes aliasing, and VPM is no exception. Higher modulator levels can produce aliasing artifacts, from low-level grunge to phantom pitches to, at the extremes, loud white noise. This becomes more of an issue with higher frequencies, such as when playing in the top octaves of the keyboard.

Sometimes, these artifacts may be useful as part of the overall timbre; other times, they may be unwelcome guests. The most valuable tool to mitigate aliasing is Key Tracking, which lets you reduce the modulator levels at higher frequencies, while keeping them stronger at lower frequencies. The MOD-7 includes dedicated multi-point key tracking for each VPM Oscillator.

Creating an initialized MOD-7 Program

For the tutorials below, we'll need to start with an initialized MOD-7 Program. To do this:

1. In **PROGRAM** mode, select factory Program **B028**, "Soft Jazz Perc."
2. Go to the **PROGRAM > Basic/X-Y/Controllers-Program Basic** page.
3. Change the **EXi1 Instrument Type** from **CX-3 Tonewheel Organ** to **MOD-7 Waveshaping VPM Synthesizer**.

If you've already been working with the MOD-7, and want to return to an initialized state:

1. Select the **EXi1 Instrument Type** parameter.
2. Use the **-** button to change it to **PolysixEX**.
3. Use the **+** button to toggle it back to **MOD-7**.

Individual oscillators and subtractive synthesis

Each of the six VPM Oscillators can be used on its own, to generate sine, saw, triangle, or square waveforms, plus timbres created by waveshaping. You can layer multiple VPM Oscillators together, modulate their volumes, and process them through filters for standard subtractive synthesis.

Layering six saw oscillators

Let's start by creating a simple sound with six layered sawtooth oscillators.

1. Follow the instructions under "Creating an initialized MOD-7 Program," above.
2. Press the PAGE button, and then press the MOD-7 tab.

The MOD-7's tabs will appear on the right.

3. Press the Patch Panel button.

The Patch Panel will appear. This shows all of the basic building blocks of the MOD-7, including all of the oscillators, filters, mixers, and so on.

The Algorithm name is shown in the upper left-hand corner. By default, it's set to **Blank Patch**.

4. Open the Algorithm pop-up, and select **05: All carriers -> 4-pole**.
5. Press OK to confirm the selection and close the popup.

As a shortcut, you can also select the Algorithm name on the Patch Panel page, and then enter the Algorithm number from the dial, or +, - buttons.

Notice that the lines on the Patch Panel have changed. These show the normalised connections between the various blocks. ("Normalised" is a term used in patchbays and modular synths, meaning the default internal connections between patch points.)

05 All carriers -> 4-pole has outputs from all six VPM Oscillators mixed into a single filter.

The VPM Oscillators are shown as a line of six boxes, running from 1 at the top to 6 at the bottom. The boxes are labeled simply with the numbers 1 through 6. Each has two input jacks, colored red, and one output jack, colored blue.

6. Touch the blue circle (the output) on VPM Oscillator 1.

A yellow highlight box will appear around the output jack, to show that the jack is selected.

Look in the upper right-hand corner of the page. This is the Parameter Details area; it shows additional information about the selected item. In this case, it will show that you've selected the output of VPM Oscillator 1, along with the output level and the inputs to which it is connected (if any). It also has two buttons: **Jump** and **Disconnect**.

7. Press the Jump button.

This takes you to the selected block's page—in this case, the VPM Oscillator 1 page. You can use this shortcut with any of the blocks on the Patch Panel.

8. On the VPM Oscillator 1 page, set the Mode to Saw.

This controls the basic timbre of the oscillator.

9. Set the Ratio Fine to +0.004.

This causes the pitch to be very slightly higher than nominal. We're going to detune all six oscillators, to create a fat, stacked sawtooth timbre.

10. Using the tabs, select each of the other VPM Oscillators in turn. For each one, set the Mode to Saw, and set the Ratio Fine as noted below.

- Osc 2: -0.004
- Osc 3: +0.008
- Osc 4: -0.008
- Osc 5: +0.014
- Osc 6: -0.014

Now, try playing the keyboard. It should sound like a thick, detuned sawtooth timbre, with a "digital" tone quality.

To warm it up a bit, let's make it so each oscillator starts with a random phase.

11. For each of the VPM Oscillators, set the Phase Sync (in the Oscillator section) to Random.

Notice how this makes the sound more full and rounded.

VPM (aka FM)

Basic VPM

To start using VPM in earnest, simply connect the output of one VPM Oscillator to the input of another. You can do this either by selecting an algorithm, or creating a patch cable. For instance:

1. **Follow the instructions under “Creating an initialized MOD-7 Program,” above.**
2. **Press the PAGE button and the MOD-7 tab, and then press the Patch Panel button.**

The Patch Panel will appear.

3. **Set the Algorithm to 08: 2 + 2 + 2 -> Parallel Filters.**

This groups the six VPM Oscillators into three carrier-modulator pairs.

4. **Press one of the VPM oscillator 3 jacks, and press the ON check button at top right to turn it off.**

5. **Do the same for VPM oscillators 4–6.**

This mutes VPM oscillators 3–6. From here, we’ll only be working with VPM oscillators 1 and 2.

6. **Press the PAGE button, the HOME button and then the Tone Adjust tab. The PROGRAM > Home– Tone Adjust page will display.**

7. **Press the Slider 9–17 button and lower Slider 9 to the bottom of its range, and play the keyboard.**

Lowering Slider 9 turns VPM Oscillator 1’s volume all the way down. This means that you’ll hear only VPM Oscillator 2, which plays a pure sine wave.

8. **While playing the keyboard, slowly raise Slider 9 to the middle of its range, or slightly higher.**

As you raise Slider 9, listen to how the timbre changes to be increasingly bright. What you’re hearing is FM synthesis: VPM Oscillator 1 is modulating VPM Oscillator 2. By controlling the level of VPM Oscillator 1, Slider 1 controls the amount of modulation.

In this algorithm, using standard FM terms, VPM Oscillator 1 is a modulator, and VPM Oscillator 2 is a carrier.

9. **Press the Slider 1-8 button. While playing the keyboard, very slowly raise or lower Slider 1.**

Slider 1 controls the Ratio, or fundamental pitch, of VPM Oscillator 1. Since VPM Oscillator 1 is acting as a modulator, this changes the timbre of the sound.

10. **Experiment with different settings of Slider 1 and Slider 9.**

Notice how Slider 1 changes the overtone frequencies created by the FM, while Slider 9 changes their intensity.

11. **Press the slider 1–8 button. While playing the keyboard, press the switch 1 to turn it on and off.**

This enables and disables VPM Oscillator 1. When it’s off, you’ll hear VPM Oscillator 2 on its own: a pure sine wave. When programming, this is a handy way to find out how an individual VPM Oscillator is affecting the overall sound.

Feedback

Continuing from the above, let’s take a brief look at **Feedback**. This causes the VPM Oscillator to modulate itself, essentially acting as both the carrier and the modulator at the same time.

1. **Press the Tone Adjust Switch 1.**

This mutes VPM Oscillator 1.

2. **Play the keyboard.**

Notice that the sound is now a sine wave, since we’re hearing only the un-modulated VPM Oscillator 2.

3. **Go to the VPM Osc 2 page.**

If you’re still on the Patch Panel page, you can do this by selecting any of the jacks on Osc 2 and then pressing the Jump button in Parameter Details.

4. **While playing the keyboard, slowly raise the Feedback parameter to about 65.**

Notice how the sound becomes brighter, almost like sweeping the filter on an analog synth. In fact, when **Feedback** is at 65, the sound is very close to a sawtooth waveform.

You can modulate the **Feedback** level, and also choose between two different feedback paths. For more information, see “Feedback” on page 327.

Phase

In some cases, the phase relationship between the carrier and modulator has an interesting effect on the sound. Continuing from the above:

1. **Lower VPM Osc 2’s Feedback to 0.**

2. **Go to the VPM Osc 1 page.**

3. **In VPM Osc 1, set the Ratio to 1.**

Now, both VPM Osc 1 and 2 are set to the same Ratio, for the most basic FM timbre: a carrier/modulator ratio of 1.

4. **Press the Tone Adjust Switch 1.**

5. **Set the Tone Adjust Slider 9 to the middle of its range.**

6. **While playing the keyboard, slowly increase VPM Osc 1’s Phase from 0 to 90.**

Notice how the timbre changes.

Phase has a strong effect with carrier/modulator ratios of 1:1 and 2:1, but is much more subtle (or not noticeable at all) at other ratios.

Detuning

Let’s look at what happens when the carrier and modulator are slightly out-of-tune. Continuing from the above:

1. **Set VPM Osc 1’s Phase back to 0.**

2. **While playing the keyboard, use the + button to change VPM Osc 1’s Freq Offset from +0000Hz to +0001 Hz.**

Notice how this introduces a chorus effect into the sound.

3. **While playing the keyboard, use the – button to change the Freq Offset back to +0000Hz.**

Notice how the sound becomes more flat and static. A small amount of detuning can add a lot of interest to the sound.

- 4. While playing the keyboard, use the + button to change VPM Osc 1's Ratio Fine from +0.000 to +0.003.**

This also adds a chorusing effect. There's a difference between changing the **Ratio** and the **Freq Offset**, however, as we'll see next:

- 5. Play different ranges of the keyboard: low, middle, and high, including all the way up to the top of the keyboard.**

Notice how the speed of the chorus effect gets faster as you play higher. With **Freq Offset**, on the other hand, the speed stays the same across the keyboard. Each is useful for different purposes.

- 6. While playing the keyboard (arpeggios, for instance), use the VALUE dial to sweep VPM Osc 1's Ratio Fine throughout its range.**

Notice how the effect changes with broader detuning, including new frequencies appearing both above and below the root pitch.

Envelopes and VPM

Each VPM Oscillator can have its own volume envelope. As we've noticed by using the Tone Adjust slider 9, changing the level of a modulator affects the intensity of the FM. Envelopes let you create interesting timbres by varying that intensity over time.

Continuing from the above:

- 1. Set VPM Osc 1's Ratio Fine back to +0.000.**

The main Ratio should still be set to 1.

- 2. Set the Output Level to 75.**
- 3. Notice that the Output section's EG Select is set to EG1.**

This is the EG assigned to control the VPM Osc's volume. By default, EGs 1-6 are assigned to VPM Osc 1-6.

- 4. Go to the EG1 page, by pressing first the PAGE button and then the MOD-7: EG button.**
- 5. Set the Break and Sustain Levels to 00.**
- 6. While playing the keyboard, experiment with different settings of the Tone Adjust Slider 1 and 9.**

These change the Ratio and Output Level of VPM Osc 1. Notice the different sounds that this creates. Slider 9 will often work well in the mid-to-low ranges; don't keep it at the maximum level!

Next, let's create a more percussive sound:

- 7. In EG1, set the Decay Curve to 10(Exp).**
- 8. Set the Decay Time to 22.**
- 9. While playing the keyboard, experiment with different settings of the Tone Adjust slider 1 and 9.**

Depending on the **Ratio** (as set by Slider 1), this creates percussive sounds with woody or metallic characters.

Modulating Ratio

So far, we've been using Tone Adjust to control Ratio. You may also sometimes want to modulate this with other controllers, or even with LFOs, EGs, and so on.

Ratio is one way of looking at pitch. On the MOD-7, you can modulate each VPM Oscillator's pitch in semitones and cents, just as with other NAUTILUS EXi. To do so, continuing from above:

- 1. Set VPM Osc 1's Ratio to 4.**

Notice that the Parameter Details area, in the upper right of the screen, now has the heading "Pitch Modulation." This appears when any of the Ratio or Freq Offset parameters are selected.

- 2. Set AMS1 to SW1 Mod (CC#80), and Intensity to +12.00.**

Now, pressing SW1 will raise the pitch of VPM Osc 1 by an octave.

- 3. Press SW1, to turn it on.**

Notice how this changes the timbre of the attack.

- 4. Change AMS1 to LFO1.**

Now, the pitch is modulated by LFO1. This gives the attack a swooping character, kind of like of a water droplet.

Filtered VPM

Vintage FM synths didn't have filters. If you wanted the sound to be darker, or thinner, or change in timbre at all, you had to make it happen using FM.

Filtering adds another dimension to VPM, both in terms of timbral possibilities and ease of use. For instance, if you like the basic timbre but want it to be a little more mellow, you can use a lowpass filter.

FM sweeps and resonant filter sweeps have different qualities; use each for what it does best, or use them together. Use highpass or bandpass filters, resonance, or the MultiFilter to achieve sounds impossible with FM alone.

Filters can even be used in-between modulators and carriers, as part of the VPM processing chain.

Filtering the VPM output

Filtering the output of a set of VPM Oscillators is simple and effective. To do so:

1. Follow the instructions under “Creating an initialized MOD-7 Program” on page 301.
2. On the MOD-7 Patch Panel, set the Algorithm to 08: 2 + 2 + 2 -> Parallel Filters.
3. Press the PAGE button, the HOME button and then the Tone Adjust tab. The PROGRAM > Home– Tone Adjust page will display.

4. Press the Tone Adjust switches 3 through 6.

This mutes VPM Oscillators 3–6.

5. Go to the VPM Osc 1 page.

Just select one of the jacks on VPM Osc 1, and press the Jump button in the Parameter Details area.

6. Set the Output section's EG Select to None.

This means that the volume will be at its maximum, unaffected by an EG.

7. Go to the PROGRAM > MOD-7: Filter– Basic page.

8. Set Filter A's Resonance to 65.

9. While playing, move Slider 7 and 9, and compare the different effects that they create.

Slider 9 controls the VPM Osc 1 Level, and thus the intensity of the FM on VPM Osc 2. Slider 7 controls Filter A's Frequency, and so moving it creates a filter sweep.

Filtering VPM modulators

You can also use filters as part of the VPM processing chain, between modulators and carriers. To do so, continuing from the above:

1. Go to the Patch Panel page.
2. Select Input 1 of the Output Mixer (“Main Mix”).

The Output Mixer is the tall block on the far right of the Patch Panel, and Input 1 is the top-most jack. Look in the Parameter Details area to verify that you've selected Main Mix and In 1.

3. Set In 1's Level to 0.

When you select a jack, its level is always selected as well. So, you can use the data entry controls immediately, without needing to select the on-screen Level parameter.

4. Touch Filter A's output (the blue jack), and drag to the first input jack on VPM Osc 4.

There should now be a brown cable connecting the output of Filter A to In 1 of VPM Osc 4.

Look in the Parameter Details area, and verify that it says Osc 4 at the top. Also, verify that the middle line reads In 1 -> Filter A, Out.

You've now created a complex VPM patch, like this:

VPM Osc 1 -> VPM Osc 2 -> Filter A -> VPM Osc 4

5. Go to Filter A, and set its Resonance to 00.

6. On the Tone Adjust, press switch 4.

This turns on VPM Osc 4.

7. Also on the Tone Adjust, set Slider 9 to the middle, and move Slider 10 all the way up.

8. Experiment with moving Slider 7 and Slider 10.

Slider 7 controls Filter A cutoff, and Slider 10 controls VPM Osc 2 Level. Listen to the different effects.

Note that VPM Osc 2 is now a modulator, affecting the timbre of VPM Osc 4. We aren't hearing VPM Osc 2 directly.

9. Move Slider 10 to the top of its range.

Slider 10 controls the output volume of VPM Osc 2.

10. Set Filter A's Type to Band Pass.

11. While playing, sweep Slider 7 between the minimum (all the way left) and the middle.

This produces interesting sounds—definitely filter-like, but not the same as using a filter in traditional subtractive synthesis.

PCM as a VPM modulator

All of the examples above use VPM Oscillators as modulators, but you can also use the PCM Oscillator, Noise Generator, and the EXi Audio Input as modulators.

For instance, here are two quick tutorials in using PCM as an FM modulator, which was a popular feature on a few later-generation vintage FM synths.

Single Multisample as VPM modulator

1. Follow the instructions under “Creating an initialized MOD-7 Program” on page 301.
2. On the Patch Panel page, press the button to the left of the Algorithm name to open the Algorithm Select popup.
3. In the Algorithm Select popup, select the Processing tab.

This small set of algorithms is designed for processing PCM or the EXi Audio Input through one or more VPM Oscillators.

4. Select Algorithm 51, PCM -> 1 -> 4-pole.
5. Go to the MOD-7: Oscillator– PCM Mod page.
6. Set the Octave to +1[4’].

Since VPM Osc 1’s Ratio is set to 1, this creates an FM ratio of 2:1.

7. Set the Output Level to 67.
8. Set the Velocity Sens to +050.

This lets velocity control the output level.

9. Go to the MOD-7: Oscillator– PCM Osc page, and select different Multisamples for MS1.

The choice of Multisample dramatically affects the sound. You can use any mono Multisamples, including ROM, EXs, User Sample Banks, and SAMPLING mode data. Try these to start:

- Choir: 203 Voice-Choir

- Wavestation: 0597 “puh”
- Wavestation: 0619 VS 35
- SE 1: 1200 House Hits

Velocity-switched Multisamples

Of course, you can also velocity switch between different Multisamples. Continuing from the above:

1. On the MOD-7: Oscillator– PCM Osc page, all MS1...4’s Type parameters to Multisample.

2. Set MS1...4’s Multisamples as follows:

- MS1: 0510: MuteGtr2
- MS2: 0511: MuteGtr3
- MS3: 0509: MuteGtr1
- MS4: 0518: BassHarm

3. Next, set the Bottom Velocities as follows:

- MS1: 110
- MS2: 95
- MS3: 080

(MS4’s Bottom Velocity is always set to 1.)

4. Go to the MOD-7: Oscillator– PCM Mod page.
5. Set the Output Level to 100, and the Octave to +0[8’].
6. Play the keyboard at different velocities, and notice how the timbre changes.

PCM samples can often be very bright and harmonically complex. When using bright or complex signals as FM modulators, high levels going into the carrier may result in lots of noise; to get good results, you may need to lower the modulator’s level significantly. You might also try processing the PCM (or any bright modulator signal) through a lowpass or bandpass filter, before sending it into the carrier.

Waveshaping

Waveshaping processes an input through a table, changing its timbre. You can use this in two different but related ways.

First, waveshaping offers a wide array of waveform options for the VPM Oscillator. There are 101 tables to choose from, and the way that the table interacts with the input signal can be modulated in real-time.

Second, waveshaping lets you process any signal, including PCM samples, the outputs of other oscillators, or real-time audio input. This capability provides a vast amount of sound-mangling potential, and has been a central feature of several classic digital synths.

For more information, see “5–4c: Waveshaper” on page 328.

Creating different waveforms

As with most other synthesis techniques, modulation is what really makes waveshaping come alive. Even without any modulation, however, waveshaping opens up a wide range of different waveforms, which can be useful both on their own, and as elements in an FM chain.

1. Follow the instructions under “Creating an initialized MOD-7 Program” on page 301.

2. Go to the MOD-7: Oscillator– VPM Osc 1 page.

3. Set the Mode to Sine + Waveshaper.

4. In the Waveshaper section, set Key Slope to 1.

Key Slope scales the Drive as you play higher and lower, primarily to minimize aliasing. 1 is a very mild setting, reducing Drive by 0.2dB per octave above C4.

5. Set the Table to Linear.

6. Use + to step through tables; listen to the sound.

Each of these simple, static waveforms can be altered—sometimes dramatically—by using Offset and Drive, even without any real-time modulation. They’ll also have different effects depending on the input signal; a complex, acoustic Multisample will give different results than a simple sine wave.

Using Offset

By modulating offset, we can make a quick-and-simple reed piano sound, using only a single VPM Oscillator.

Continuing from the above:

1. **In the Waveshaper section of VPM Osc 1, set the Offset to +090.**
2. **In the Parameter Details area, set Offset AMS to Exponential Velocity, and set Intensity to -090.**
3. **Set Drive to -06dB.**
4. **Set Makeup Gain to +06dB.**
5. **Set the Table to Pickup1.**

In the popup list, **Pickup1** is near the top of the first column.

6. **Set Key Slope to 5.**

The steps are in 0.2dB/octave, so 5 is 1dB/octave.

7. **Play the keyboard, and notice how the sound changes at different velocities.**

Creating evolving timbres

Next, let's see how waveshaping sounds when modulated from an envelope. Continuing from the above:

1. **Go to the MOD-7: EG– EG3 page.**
2. **Set the Attack Time to 70, and the Decay Time to 90.**
3. **Set both the Break and Sustain Levels to 00.**

This creates an envelope which sweeps slowly up and down.

4. **Go to the VPM Osc 1 page.**
5. **Set Offset to +000.**
6. **In Parameter Details, set Offset AMS Intensity to +000.**
7. **Set the Drive to -36dB.**
8. **In Parameter Details, set Drive AMS to EG3, and Intensity to +36dB.**

By modulating the Drive, EG3 changes the way that the table interacts with the input signal—creating an effect that varies over time.

9. **Set the Table to Forest.**

In the popup list, **Forest** is near the top of the fourth column.

10. **While playing the keyboard, use + to step through the different tables.**

This is a fairly slow envelope, so for this example just play simple chords, and hold them to hear the sound as the EG sweeps through the table.

Waveshaping and VPM

Continuing from the above:

1. **Go to the Patch Panel page.**
2. **Touch VPM Osc 1's Output jack, and drag to VPM Osc 2's Input 1 jack.**

A patch cable will appear, connecting VPM Osc 1's Output to VPM Osc 2's Input 1.

3. **Similarly, touch VPM Osc 2's Output jack, and drag to Input 1 on the Output Mixer.**

Input 1 is the top-most jack on the Output Mixer, just below the Parameter Details area. VPM Osc 1 is connected to this jack by default, as you can see by the thin black line. The new patch cable replaces that normalised connection, so now we'll hear only VPM Osc 2.

Next, let's get rid of the Drive modulation, so that we can hear the table on its own:

4. **Go to the MOD-7: Oscillator– VPM Osc 1 page.**
5. **Set Drive to 0dB.**
6. **In Parameter Details, set Drive AMS Intensity to 0dB.**
7. **Set the Table to Linear.**

This will sound just as if Osc 1 was set to the Sine waveform.

8. **Use + to step through the tables, and go to the PROGRAM > Home– Tone Adjust page to experiment with different settings of Slider 9 (VPM Osc 1 Output Level).**

Start with Slider 9 around the mid-point, and keep trying out different levels as you listen to the different tables. The brighter the modulator's waveform, the less level you'll need. If the level is too high, you'll start to hear noise and grit.

Finally, let's bring back the EG3 modulation of Drive:

9. **Set Drive to -36dB.**
10. **In Parameter Details, set Drive AMS Intensity to +36dB.**
11. **Again, use + to step through the tables, and experiment with different settings of Slider 9.**

Waveshaping and PCM

You can use waveshaping to alter any mono sample in the NAUTILUS, including sounds from ROM, EXs, User Sample Banks, and SAMPLING mode.

Continuing from the above:

1. **Go to the Patch Panel.**
2. **Select Algorithm 51, PCM -> 1 -> 4-pole.**
3. **Open the menu, and select the Delete All Connections command.**

An "Are you sure?" dialog will appear.

4. **Press OK to confirm the deletion.**

All of the cables will disappear, returning the algorithm to its default state.

5. **Go to the PCM Osc page.**
6. **Set MS1 Multisample to 0330:El.Bass-Slap Muted.**
7. **Go to the PCM Mod page.**
8. **Set Velocity Sens +050.**

This makes the level respond to velocity. Since the waveshaper's effect changes with the input level, this means that velocity will also affect the timbre.

9. **Go to the VPM Osc 1 page.**

10. **Set the Mode to Waveshaper.**

This means that VPM Osc 1 is no longer an oscillator per se; instead, it's functioning as a waveshaper, processing the output of the PCM Oscillator.

11. **Set the Table to Resonant2.**

In the popup list, **Resonant2** is near the middle of the third column.

12. Set Drive to -30dB.

13. In Parameter Details, Set Drive AMS to EG3, and set the Intensity to +30dB.

14. Set Offset to +50.

15. In Parameter Details, Set Offset AMS to Exponential Velocity, and set the Intensity to -50.

16. Set the Makeup Gain to +24dB.

17. Play a slow bass line on the keyboard.

Notice the “filter sweep” sound. This comes entirely from modulating the drive through the table; by itself, the multisample has a very dark tone.

Waveshaping and filtered PCM

Using PCM with waveshaping produces unique results, but it can also be tricky to control. You’ll probably need to experiment to find which tables best match a particular Multisample. Often, waveshaping works better with darker input sounds, so it may be useful to patch in a lowpass filter between the PCM and the VPM Oscillator.

Continuing from the above:

- 1. Go to the PCM Osc page.**
- 2. Set MS1 Multisample to 0201:Voice-Pop Ah.**
- 3. Go to the Patch Panel.**
- 4. Connect the PCM Osc Output to Filter A’s Input.**
- 5. Connect Filter A’s Output to VPM Osc 1’s Input 1.**
- 6. Connect VPM Osc 1’s Output to Input 1 on the Output Mixer.**

Now, the signal flow is PCM -> Filter A -> VPM Osc 1 -> Output.

7. Play the keyboard.

At this point, the sound is pretty buzzy. Let’s see what the filter will do:

- 8. While playing a chord in the middle of the keyboard, move Tone Adjust Slider 7 so that it’s slightly below the center.**

This lowers the cutoff frequency of the filter, so that the sound changes from buzzy to mellow—but the waveshaper is still having a strong effect.

Waveshaping, PCM, and VPM

You can use Waveshaping, PCM, and VPM simultaneously, for even more complex timbres.

Continuing from the above:

- 1. Go to the PCM Mod page.**
- 2. Set Freq Offset to +01.0.**

The PCM will be a modulator in this sound, and so this adds a little chorus effect to the end result.

- 3. Go to the VPM Osc 1 page.**
- 4. Set the Mode to Sine + Waveshaper.**

Now, VPM Osc 1 works as an oscillator again, and we’re back in the realm of FM synthesis. The filtered PCM sound is the modulator, and the VPM Osc is the carrier.

- 5. Set Input Level 1 to 80.**

This controls the intensity of the modulation from the filtered PCM.

6. Set the Table to Mixture4.

In the popup list, **Mixture4** is near the bottom of the second column.

7. Set Drive to -36dB.

8. In Parameter Details, set the Drive AMS Intensity to +30dB.

This means that the input won’t quite use the entire table, and leaves room for Offset to move the active region of the table without clipping.

9. Experiment with different settings of Slider 7.

This controls the cutoff frequency of Filter A. This filter isn’t processing the output of VPM Osc 1; it’s just affecting the modulator signal going *into* VPM Osc 1. VPM Osc 1 itself is connected directly to the Output Mixer, bypassing the filters.

Finally, note that all of the examples above used only a single VPM Oscillator—just a fraction of the MOD-7’s resources. You can process PCM through all six VPM Oscillators, in serial or parallel.

Ring Modulation

Ring modulation takes two input signals, and creates new frequencies based on those inputs. It can create everything from subtle brightening effects to wild, dissonant, gong-like timbres.

In the MOD-7, each VPM Oscillator includes a ring modulator. You can use this to process any combination of VPM, PCM, noise, and real-time audio input. You can also modulate the wet/dry crossfade of the ring modulator, in real-time.

For more information, see “5–4e: Ring Modulator” on page 333.

Subtle motion

Let’s first look at a subtle use of ring modulation, to create some motion in a simple sawtooth timbre.

1. Follow the instructions under “Creating an initialized MOD-7 Program” on page 301.

To start, we’ll create an envelope for modulation:

- 2. Go to the EG3 page.**
- 3. Set the Attack Time to 70, and the Decay Time to 90.**
- 4. Set both the Break and Sustain Levels to 00.**

Next, let’s connect VPM Osc 2 to VPM Osc 1:

- 5. Go to the Patch Panel.**
- 6. Connect VPM Osc 2’s Output to VPM Osc 1’s Input 1.**
- 7. Go to the VPM Osc 2 page.**
- 8. Set the Ratio to 2.**
- 9. In Parameter Details, set Pitch Modulation AMS1 to EG3, and set the Intensity to +00.10.**

This small amount of pitch modulation will create a more subtle ring modulation effect.

- 10. Go to the VPM Osc 1 page.**
- 11. Set the Mode to Saw.**
- 12. Set Input Level 1 to 0.**

This means that VPM Osc 2 will only affect the ring modulator.

- 13. Set the LPF to 50.**
- 14. Play the keyboard; so far, this is a simple sawtooth sound.**
- 15. On the VPM Osc 1 page, select the Ring Mod Crossfade parameter.**
- 16. In Parameter Details, set the Crossfade AMS to EG3, and the Intensity to 100.**

Now, EG3 is doing two things: it’s changing the pitch of VPM Osc 2, and fading the ring modulation in and out. Together, this creates a fluttering, rolling effect.

Attack transient

Next, we’ll use ring modulation to create an attack transient. Continuing from the above:

- 1. Go to the EG3 page.**
- 2. Set the Attack Time to 00, and the Decay Time to 40.**
- 3. Go to the VPM Osc 2 page.**

- 4. Set the Mode to Saw.**
- 5. Set the LPF to 60.**
- 6. Select the Ratio parameter.**

This makes the Pitch Modulation parameters appear in the Parameter Details area.

- 7. Change the AMS1 Intensity to +02.00.**
- This will result in a stronger ring modulation effect.

- 8. Go to the VPM Osc 1 page.**
- 9. Set the Mode to Sine.**

This makes the effect of the ring modulation more obvious, when crossfaded in and out.

10. Play the keyboard.

Now, the ring modulation is creating a chuff at the start of the note.

Extreme sweep

For a more surreal ring modulation effect:

- 1. Go to the EG3 page.**
 - 2. Set the Decay Time to 80.**
 - 3. Go to the VPM Osc 2 page.**
 - 4. Set the Ratio Fine to +0.002.**
- This will create a little motion in the sustained sound, after the initial sweep is complete.
- 5. Go to the VPM Osc 1 page.**
 - 6. Set the Mode to Saw.**
 - 7. Set the Ring Mod Crossfade to Ring Mod.**
 - 8. In Parameter Details, set the AMS Intensity to 000.**

Now, the output will contain only the ring mod sound. Previously, the sound had crossfaded between the dry and ring mod timbres.

- 9. Play a chord on the keyboard, and hold it until the sound settles.**

Conclusion

We’ve now looked at most of the synthesis techniques provided by the MOD-7, including subtractive, VPM, PCM + VPM, waveshaping, and ring modulation. To step beyond the basics, try looking through some of the factory sounds to see how they work. There’s still much more to discover, and we hope that you enjoy playing and working with the MOD-7 as much as we do!

EXi PROGRAM > MOD-7: Home

0–1: Overview



This is the main page of PROGRAM mode. For a full description of this page and all of its functions, please see “EXi PROGRAM > Home” on page 127. This section describes only the overview display, which differs for each individual EXi.

0–1b: Overview and Page Jump

This part of the page shows an overview of the most important settings for the Program’s two EXi instruments. The specific parameters will vary, depending on which EXi are being used. The specific parameters for the MOD-7 are described below.

The graphics give you a quick way to check all of these settings at a glance. They also let you jump instantly to any of the displayed parameters. Just touch one of the sections, and you’ll jump to the page containing its parameters. For instance, if you touch the Filter graphic, you’ll go to the Oscillator and Filter page.

Tip: Pressing EXIT several times will always bring you back to this page.

Patch Panel

This section shows a miniature version of the patch panel, including patch cables and the selected algorithm’s normalised connections. Touch this area to jump directly to the Patch Panel page.

Filter**Filter**

This shows a graphic representation of the filter frequency response, including cutoff and resonance.

Press this area to jump to the Filter Basic page.

Amp**Pan, Amp Level**

This shows the Amp section’s **Pan** and **Amp Level** values. Press this area to jump to the Amp page.

EGs, LFOs, and Step Sequencer**EG Graphics**

These show the shapes of all 10 EGs, including EGs 1-9 and the Amp EG. Touch either of them to jump directly to the corresponding edit page.

LFO 1-4 Graphics

These show the waveforms and shapes of the four LFOs. Touch them to jump directly to the corresponding edit page.

If the LFO is synchronized to tempo, a small “M” appears under the LFO number (short for “MIDI Clock”).

Step Sequencer Graphic

This shows a graphic overview of the per-voice Step Sequencer.

Press this area to jump to the Step Sequencer page.

Key Zone**Key Zone**

This shows the key zones for EXi1 and EXi2, as set on the Common section’s Program Basic page, in relation to the entire MIDI note range. The range of the 61-, 73-, or 88-note keyboard is also shown, as appropriate.

Press this area to jump to the PROGRAM > Basic/X-Y/Controllers– Basic page.

0-1d: Common**3Band EQ Graphic****Mute (1)** [On, Off]**Mute (2)** [On, Off]**Mute (DrumT)** [On, Off]**EXi1 Instrument Volume** [000...127]**EXi2 Instrument Volume** [000...127]**Drum Track Volume** [000...127]

This is the same as with HD-1 programs. For more information, please see “0-1d: Common” on page 4.

✓ 0-1: Page Menu Commands

- Compare →p.112
- Write Program →p.112
- Exclusive Solo →p.113
- Show MS/WS/DKit Graphics →p.113
- Add To Set List →p.113
- Initialize Program →p.113

- PAGE →p.126
- MODE →p.126

PROGRAM > MOD-7: Patch Panel

4-1: Patch Panel



The patch panel shows an overview of most components in the MOD-7, and lets you:

- Control the connections between components (oscillators, filters, mixers, and so on) by selecting algorithms and/or using patch cables
- Edit input and output levels for all components
- Jump directly to the detailed editing pages for all components

Using the Patch Panel

Algorithms

Depending on the selected algorithm, many of the MOD-7 elements (VPM oscillators, PCM oscillator, Noise Generator, filters, mixers, etc.) are connected by default, even without using any patch cables. The lines and arrows on the Patch Panel show these “normal” signal paths.

You can change any and all of these default connections using patch cables, as desired. Plugging a cable into an *input* jack disconnects the “normal” path, and uses the signal from the cable instead. Plugging a cable into an *output* jack does not affect the normal path, since a single output can be connected to any number of inputs.

For more information on using algorithms, see “4-1a: Algorithm Select” on page 313.

Basic patching rules

Inputs are colored red, and outputs are colored blue.

Each input can be connected to a single output, and no more (although a single *output* can be connected to multiple *inputs*, as described below). If you want to route two outputs to a single input, use one of the mixers to merge the outputs first.

Plugging a cable into an output jack lets you use the signal elsewhere on the patch panel, and does not interrupt the “normal” path. You can also connect a single output to any number of inputs, if you like; this is sometimes called a “mult.” The signal strength remains the same, as if you were using a distribution amplifier.

Connections from one input to another, or from one output to another, are not allowed.

Creating and deleting connections

You can make connections on the Patch Panel by touch-dragging from an output to an input, or vice-versa.

Similarly, you can delete connections by touching an input jack and dragging the cable away. To delete all connections from an output in a single step, touch the output jack and then press the Disconnect button in the Parameter Details area.

To completely clear the Patch Panel, so that you can start from scratch, open the menu and select the Delete All Connections command.

For more details on using NAUTILUS Patch Panels, see “Using the Patch Panel” on page 267.

Setting input and output levels

You can edit the main input and output levels for each block directly from the Patch Panel. To do this:

1. Select the jack whose input level you want to edit.
For instance, select Input 2 of VPM Oscillator 4.
2. Use the standard data-entry controls to set the level as desired.

Note that modulation can affect these levels, as well—so you may have to look at the individual edit pages to get the complete picture.

Jumping directly to edit pages

You can jump to the detailed edit pages for any of the blocks shown on the Patch Panel. To do this:

1. **Select a jack on the block that you want to edit.**

You can select any input or output on the block.

2. **Press the Jump button in the Parameter Details area, at the top right of the display.**

This will take you directly to the page of the selected jack's block. For instance, if you've selected one of the inputs or outputs of VPM Oscillator 2, pressing **Jump** will take you to the **VPM Osc 2** page.

Muting oscillators

The PCM Oscillator and each VPM Oscillator can be muted temporarily, so that you can hear their effect on the sound. To do this, select any of the block's input or output jacks, and edit the check-box in the parameter details area. You can also use Tone Adjust buttons 1-6 (VPM Osc 1-6) and 9 (PCM), which are assigned to these parameters by default.

Filter B and 4-pole routing

When the filter **Routing** is set to **4-pole**, only Filter A is active. Filter B no longer passes any audio from input to output, and both input and output jacks are grayed out.

Any cables previously connected to Filter B will remain in place, with their color changed to black & red to indicate the filter's disabled status.

4-1a: Algorithm Select

Algorithm [List]

Algorithms do three things:

- They create a set of default connections between the elements on the Patch Panel, which can then be altered as you wish using patch cables.
- As part of these connections, they set the Link parameters for Mixers 1, 2, and 3, as well as the Filter's 4-pole/Parallel parameter.
- They specify which VPM Oscillators are carriers, and which are modulators. This affects the way that the Macro parameters work. You can edit these settings after selecting an Algorithm, if desired, to account for changes due to user-created patch cables or oscillator settings.

Algorithm groups

The algorithms are divided into several groups, selected by tabs on the left-hand side of the Algorithm Select popup.

VPM includes the most useful configurations of VPM Oscillators, routed through either 4-pole or parallel filters. The PCM and Noise algorithms, below, are primarily based on this set of configurations.

The first entry, **Blank Patch**, is a special algorithm with only the simplest of connections: VPM Oscillator 1 goes straight into the Output Mixer. Use this if you want to build your own algorithm from the ground up.

PCM + VPM offers a selection of VPM configurations layered with PCM samples.

PCM->Filter->VPM includes the standard set of configurations, using PCM (through a 2-pole filter) as an FM modulator.

PCM->VPM -> 4-pole are similar, but these route the unfiltered PCM directly into the VPM Oscillators, and then processes the result through a 4-pole filter.

Noise->VPM -> 4-pole use the Noise Generator as an FM Modulator.

Many of the **PCM** and **Noise** algorithms have two variations, labeled **I** and **II**. In the **I** versions, the PCM or Noise goes to the input of a Modulator; in the **II** versions, the PCM or Noise is routed to the second Carrier input, in parallel with the VPM Modulator.

Processing are special algorithms for simple waveshaping, ring modulation, and/or FM modulation with PCM or live audio input.

Vintage DX features all of the original DX7 algorithms, without any filtering. Feedback is much more flexible on the MOD-7 than it was on the DX7, and so when the original algorithms differed only by feedback routing, they've been grouped into a single selection. To disable an external feedback routing, just go to the input jack that the feedback leads to, and set its **Level** to **0**.

Remember, you can use patch cables to change any of these algorithms to suit your needs.

Which algorithm should I use?

Algorithms are just shortcuts for configuring the Patch Panel. You don't have to use them at all; if you prefer, you can just make all of your connections using patch cables.

The preset algorithms do make it easy to call up commonly-used setups, however.

In general, with more carriers, there's more potential for layering; with fewer carriers, there's more potential for complex and detailed FM modulation.

The "all carriers" algorithms (10, 20, 30, 40, 50, and DX #32) are good for creating thick layers, or for simple additive synthesis (up to 7 partials, plus noise, each with its own EG).

The Processing algorithms are a good place to start if you want to transform a PCM sample into something new, or process a live audio input.

The PCM + VPM algorithms are good for layering samples with VPM.

| # | Group | Algorithm |
|----|-------|----------------------------------|
| 0 | | Blank Patch |
| 1 | | 4+2 -> 4-pole |
| 2 | | 3+3 -> 4-pole |
| 3 | | 2+2+2 -> 4-pole |
| 4 | | 2+2+1+1 -> 4-pole |
| 5 | VPM | All carriers -> 4-pole |
| 6 | | 4+2 -> parallel filters |
| 7 | | 3+3 -> parallel filters |
| 8 | | 2+2+2 -> parallel filters |
| 9 | | 2+2+1+1 -> parallel filters |
| 10 | | All carriers -> parallel filters |

| # | Group | Algorithm |
|----|----------------------|--------------------------------------|
| 11 | PCM + VPM | PCM+4+2 -> 4-pole |
| 12 | | PCM+3+3 -> 4-pole |
| 13 | | PCM+2+2+2 -> 4-pole |
| 14 | | PCM+2+2+1+1 -> 4-pole |
| 15 | | PCM+2+1+1+1+1 -> 4-pole |
| 16 | | PCM+4+2 -> parallel filters |
| 17 | | PCM+3+3 -> parallel filters |
| 18 | | PCM+2+2+2 -> parallel filters |
| 19 | | PCM+2+2+1+1 -> parallel filters |
| 20 | | PCM+all carriers -> parallel filters |
| 21 | PCM->Filter->VPM | PCM -> 4+2 -> 2-pole I |
| 22 | | PCM -> 4+2 -> 2-pole II |
| 23 | | PCM -> 3+3 -> 2-pole I |
| 24 | | PCM -> 3+3 -> 2-pole II |
| 25 | | PCM -> 2+2+2 -> 2-pole I |
| 26 | | PCM -> 2+2+2 -> 2-pole II |
| 27 | | PCM -> 2+2+1+1 -> 2-pole I |
| 28 | | PCM -> 2+2+1+1 -> 2-pole II |
| 29 | | PCM -> 3+1+1+1 -> 2-pole |
| 30 | | PCM -> all carriers -> 2-pole |
| 31 | PCM->VPM -> 4-pole | PCM -> 4+2 -> 4-pole I |
| 32 | | PCM -> 4+2 -> 4-pole II |
| 33 | | PCM -> 3+3 -> 4-pole I |
| 34 | | PCM -> 3+3 -> 4-pole II |
| 35 | | PCM -> 2+2+2 -> 4-pole I |
| 36 | | PCM -> 2+2+2 -> 4-pole II |
| 37 | | PCM -> 2+2+1+1 -> 4-pole I |
| 38 | | PCM -> 2+2+1+1 -> 4-pole II |
| 39 | | PCM -> 3+1+1+1 -> 4-pole |
| 40 | | PCM -> all carriers -> 4-pole |
| 41 | Noise->VPM -> 4-pole | Noise -> 4+2 -> 4-pole I |
| 42 | | Noise -> 4+2 -> 4-pole II |
| 43 | | Noise -> 3+3 -> 4-pole I |
| 44 | | Noise -> 3+3 -> 4-pole II |
| 45 | | Noise -> 2+2+2 -> 4-pole I |
| 46 | | Noise -> 2+2+2 -> 4-pole II |
| 47 | | Noise -> 2+2+1+1 -> 4-pole I |
| 48 | | Noise -> 2+2+1+1 -> 4-pole II |
| 49 | | Noise -> 3+1+1+1 -> 4-pole |
| 50 | | Noise -> all carriers -> 4-pole |
| 51 | Processing | PCM -> 1 -> 4-pole |
| 52 | | PCM -> 1+1+1 -> 4-pole |
| 53 | | Audio -> 1 -> 4-pole |
| 54 | | Audio -> 1+1+1 -> 4-pole |

| # | Group | Algorithm |
|----|------------|-----------------|
| 55 | Vintage DX | DX #1 & #2 |
| 56 | | DX #3 |
| 57 | | DX #4 |
| 58 | | DX #5 |
| 59 | | DX #6 |
| 60 | | DX #7, #8, & #9 |
| 61 | | DX #10 & #11 |
| 62 | | DX #12 & #13 |
| 63 | | DX #14 & #15 |
| 64 | | DX #16 & #17 |
| 65 | | DX #18 |
| 66 | | DX #19 |
| 67 | | DX #20 |
| 68 | | DX #21 |
| 69 | | DX #22 |
| 70 | | DX #23 |
| 71 | | DX #24 |
| 72 | | DX #25 |
| 73 | | DX #26 & #27 |
| 74 | | DX #28 |
| 75 | | DX #29 |
| 76 | | DX #30 |
| 77 | | DX #31 |
| 78 | DX #32 | |

4-1b: Parameter Details

This area at the upper right of the display shows information for both the selected jack, and the block containing that jack.

(Block name) [PCM Osc, Noise, Audio In, VPM Osc 1...6, Mixer 1...3, Filter A...B, Main Mix]

This read-only parameter shows the name of the selected block.

Mode [Off, Sine, Saw, Triangle, Square, Sine + Waveshaper, Waveshaper, Ring Mod Only]

When a VPM Oscillator is selected, this read-only parameter shows the Oscillator Mode.

On [Check-box]

This check-box lets you temporarily mute the output of the block. It duplicates the similarly-named parameter on the Oscillator's page.

(Jack name) [Depends on block]

This read-only parameter shows the name of the selected jack, such as Input 1.

(Connection)**[Jack name]**

This read-only parameter shows the jack to which the selected jack is connected, including the normalised connection. If nothing is connected to the jack, the bottom line reads “(No Connection).”

If the selected jack is an output connected to multiple inputs, only the first connection is shown, followed by an ellipse.

If the default connection from Algorithm is active, it is shown in parentheses.

Input or Output Level**[0...100]**

This sets the input or output volume level of the jack. It duplicates the similarly-named parameter on the block's page.

Jump

Press the **Jump** button to go directly to the page of the selected jack's block. For instance, if you've selected one of the inputs or outputs of VPM Oscillator 2, pressing **Jump** will take you to the **VPM Osc 2** page.

Disconnect button

Pressing the **Disconnect** button clears all cables connected to the jack.

✓ 4-1: Page Menu Commands

- Compare →p.112
- Write Program →p.112
- Exclusive Solo →p.113
- Delete All Connections →p.282
- Copy VPM Oscillator →p.347
- Swap VPM Oscillators →p.347

- PAGE →p.126
- MODE →p.126

PROGRAM > MOD-7: Oscillator

5-1: Osc Main

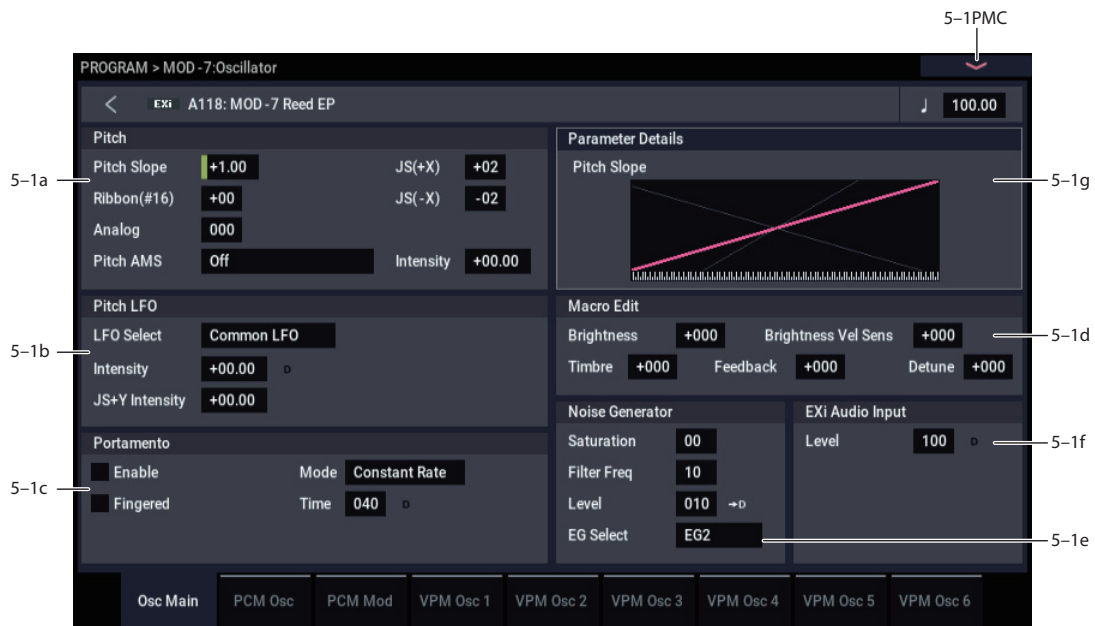

This page includes:

- Pitch slope and portamento settings
- Pitch modulation applied equally to the PCM Oscillator and all six VPM Oscillators (note that individual oscillators have their own pitch modulation, as well)
- Macro parameters, for quick edits to VPM sounds
- Carrier/Modulator settings for the six VPM Oscillators
- Noise Generator settings
- Audio Input settings

Pitch Slope, pitch, and note

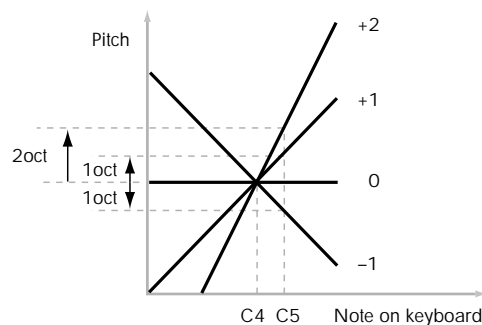

5-1a: Pitch

These parameters let you modulate the pitch of the PCM Oscillator and all 6 VPM Oscillators simultaneously, so that the modulation applies equally to all of them.

Pitch Slope [-1.00...+0.00...+2.00]

Normally, this should be set to the default of +1.00.

Positive (+) values cause the pitch to rise as you play higher on the keyboard, and **negative (-)** values cause the pitch to *fall* as you play higher on the keyboard.

When this is set to 0, playing different notes on the keyboard won't change the pitch at all; it will be as if you're always playing C4. This can be useful for special effects sounds, for instance.

If you want to create more complex effects, you can assign key tracking as an AMS source.

JS+ X [-60...+60 semitones]

This sets the maximum amount of pitch bend, in semitones, when you move the joystick to the right. For normal pitch bend, set this to a positive value.

JS- X [-60...+60 semitones]

This sets the maximum amount of pitch bend, in semitones, when you move the joystick to the left. For normal pitch bend, set this to a negative value.

Analog [000...100]

This models the instability of an analog system by adding subtle randomization to the oscillator and filter frequencies. The PCM Oscillator, each VPM Oscillator, and Filters A and B each receive different random values, and the values are different for each new note as well.

Pitch AMS [List of AMS Sources]

This selects an AMS source to modulate the pitch of all oscillators simultaneously. For a list of AMS sources, see "Alternate Modulation Source (AMS) List" on page 903.

Intensity [-48.00...+48.00]

This controls the depth and direction of the **Pitch AMS** modulation, in semitones.

Pitch Slope Parameter Details

The **Pitch Slope** graphic appears in the Parameter Details area when any of the Pitch parameters are selected.

5-1b: Pitch LFO**LFO Select** [LFO 1, LFO 2, LFO 3, LFO 4, Common LFO]

This selects an LFO to modulate all oscillators simultaneously. This shared modulation can be useful for vibrato, among other things.

The **LFO Intensity**, **JS+ Y Intensity**, and **AMS** are all summed together to produce the final amount of LFO pitch modulation.

LFO Intensity [-48.00...+48.00]

This controls the initial effect of the LFO on the pitch, in semitones, before any JS+Y or AMS modulation.

Negative (-) settings will invert the phase of the LFO.

JS+Y Intensity [-48.00...+48.00]

Moving the joystick “up” from the center detent position, away from yourself, produces the JS+Y controller. You can use this to scale the amount of the LFO applied to the pitch. This parameter sets the maximum amount of LFO modulation added by JS+Y, in semitones.

As this value is **increased**, moving the joystick in the +Y direction will cause the LFO to produce deeper pitch modulation.

Negative (-) settings will invert the phase of the LFO. You can also use this to reduce the initial amount of the LFO, as set by **LFO1 Intensity**, above.

Pitch LFO Parameter Details

These items appear in the Parameter Details area when any of the Pitch LFO parameters are selected.

AMS [List of AMS Sources]

This selects an AMS modulation source to scale the amount of the LFO applied to pitch.

For a list of AMS sources, see “Alternate Modulation Source (AMS) List” on page 903.

Intensity [-48.00...+48.00]

This controls the depth and direction of the LFO AMS modulation, in semitones.

5-1c: Portamento

Portamento lets the pitch glide smoothly between notes, instead of changing abruptly.

Enable [Off, On]

On (checked): Turns on Portamento, so that pitch glides smoothly between notes.

Off (unchecked): Turns off Portamento. This is the default state.

Fingered [Off, On]

This parameter allows you to control Portamento through your playing style. When it’s enabled, playing legato will turn on Portamento, and playing detached will turn it off again.

This option is only available when Portamento Enable is turned on.

On (checked): Turns on Fingered Portamento.

Off (unchecked): Turns off Fingered Portamento.

Mode [Constant Rate, Constant Time]

Constant Rate means that Portamento will always take the same amount of time to glide a given distance in pitch - for instance, one second per octave. Put another way, gliding several octaves will take much longer than gliding a half-step.

Constant Time means that Portamento will always take the same amount of time to glide from one note to another, regardless of the difference in pitch. This is especially useful when playing chords, since it ensures that each note in the chord will end its glide at the same time.

Time [000...127]

This controls the portamento time. Higher values mean longer times, for slower changes in pitch. When **Time** is set to **0**, the pitch will be reached instantly—just as if Portamento **Enable** was turned **Off**.

Portamento Parameter Details

These items appear in the Parameter Details area when any of the Portamento parameters are selected.

AMS [List of AMS Sources]

This selects an AMS source to control the **Portamento Time**. For a list of AMS sources, see “Alternate Modulation Source (AMS) List” on page 903.

The modulation occurs only at note-on. This means that you can change the time for the *next* pitch glide, but you can’t change any glides which are already in progress.

Intensity [-127...+127]

This controls the depth and direction of the **Portamento Time** AMS modulation.

Assigning SW1 or SW2 to Portamento On/Off

You can use the two assignable switches, SW1 and SW2, to turn portamento on and off. For more information, see “1-8b: Panel Switch Assign” on page 48.

For details on assigning functions, see “Assigning SW1 or SW2 to Portamento On/Off” on page 151.

5-1d: Macro Edit**Brightness** [-100...+100]

This controls the input levels of all Carriers (see “Oscillator Carrier/Modulator Status,” below).

Brightness Vel. Sens. [-100...+100]

This controls the output level velocity sensitivities of all Modulators.

Timbre [-100...+100]

This controls the pitches of all Modulators.

Feedback [-100...+100]

This controls the feedback levels of all Carriers.

Detune [-100...+100]

This controls the fine-tuning of all Modulators.

Macro Edit Parameter Details

Oscillator Carrier/Modulator Status

These items appear in the Parameter Details area when any of the Macro parameters are selected. They control the way that each VPM Oscillator responds to the Macro parameters, as detailed below.

Modulators are affected by the **Brightness Vel Sens.**, and **Timbre** parameters.

Carriers are affected by the **Brightness**, **Feedback** and **Detune** parameters.

The Carrier/Modulator states are set automatically when an **Algorithm** is selected, but may then be edited manually as desired, to match any special configurations on the Patch Panel.

Note that these settings only affect the way that the VPM Oscillators respond to the Macro Parameters; they do not make an oscillator into a Carrier or Modulator per se.

VPM Osc 1...6s [Carrier, Modulator]

This controls the way that each VPM Oscillator responds to the Macro parameters, as described above.

5-1e: Noise Generator

The noise generator includes **Saturation**, for creating unique and chaotic noise effects, and a dedicated 1-pole filter to control noise color.

For standard white noise, set the **Saturation** to **0**, and the **Filter Frequency** to **99**.

For colored noise (such as pink noise), set the **Saturation** to **0**, and reduce the **Filter Frequency** as desired.

To create “speckled noise” such as rocket sounds and thunder, set **Saturation** to **99**, and **Filter Frequency** to **10**.

To create key contact noise (such as you might find on vintage analog synths), create speckled noise as described above, and then use a fast EG to control its volume in the mixer.

Saturation [0...99]

This control clips the noise signal, for added crunch. Subtle variations in saturation are more noticeable with very low **Filter Frequency** settings (see below), allowing you to create organic, rumbling timbres.

Filter Freq [0...99]

This is a simple, 1-pole lowpass filter for controlling the “color” of the noise.

Level [0...100]

This sets the basic output level of the Noise Generator. It is also shown in the Parameter Details on the Patch Panel.

EG Select [None, EG1...EG9, Amp EG]

This selects any of the 10 EGs to control the Noise Generator’s output level.

None is the same as if the EG was always at its maximum level.

Noise Generator Parameter Details

These items appear in the Parameter Details area when any of the Noise Generator parameters are selected.

AMS Mode [Add, Multiply]

To calculate the Noise Generator’s output volume, the main **Level** parameter and the selected **EG** are always multiplied together. If either of these is at 0, the other has no effect. For instance, if the **Level** is set to 0, the **EG** can’t bring the volume back up again.

The **AMS Mode** parameter determines how AMS modulation (including Int Mod) interacts with these other controls.

Add: AMS is added in after **Level** and the **EG** are multiplied together. This means that even if one of these other values is at 0, AMS can still bring up the volume to its maximum.

You can also think of this as having parallel modulation paths: the EG on one side, and AMS on the other.

Expressed mathematically, this is:

$$\text{Volume} = (\text{Level} * \text{EG}) + \text{AMS}$$

Multiply: This is the default, and is similar to the way that most other NAUTILUS Amp modulation works. AMS is multiplied along with the **Level** and the **EG**. If any of these are at 0, the output will be silent.

Expressed mathematically, this is:

$$\text{Volume} = \text{Level} * \text{EG} * (1 + \text{AMS})$$

AMS [List of AMS Sources]

This selects a modulation source to control the **Level**. For a list of AMS sources, see “Alternate Modulation Source (AMS) List” on page 903.

Intensity [-100...+100]

This controls the depth and direction of the **Level** modulation.

5-1f: EXi Audio Input

Important: the audio input is only active when notes are played

The MOD-7 can process live audio inputs, feedback from effects, or any other audio from within the NAUTILUS. Note, however, that the audio input is only active when a voice is being played on the MOD-7.

It's easy to make a patch in which only the incoming audio is heard, with the built-in oscillators completely silent—but you still need to press a key (or play a note via MIDI) in order to activate the MOD-7. You can use the EXi Common **Hold** parameter to keep the note “held down” indefinitely, if you like.

Level [0...100]

This sets the basic output level of the Audio Input. It is also shown in the Parameter Details on the Patch Panel.

EXi Audio Input Parameter Details

These items appear in the Parameter Details area when any of the EXi Audio Input parameters are selected.

AMS Mode [Add, Multiply]

The **AMS Mode** parameter determines how AMS modulation interacts with the **Level** parameter.

Add: AMS is added to the **Level**. This means that even if the **Level** is set to 0, AMS can still bring up the volume to its maximum.

Expressed mathematically, this is:
Volume = Level+AMS.

Multiply: This is the default, and is similar to the way that most other NAUTILUS Amp modulation works. AMS and **Level** are multiplied together.

Expressed mathematically, this is:
Volume = Level*(1+AMS).

AMS [List of AMS Sources]

This selects a modulation source to control the **Level**. For a list of AMS sources, see “Alternate Modulation Source (AMS) List” on page 903.

Intensity [-100...+100]

This controls the depth and direction of the **Level** modulation.

- The Pitch Slope graphic appears when any of the Pitch parameters are selected.

✓ 5-1: Page Menu Commands

- Compare →p.112
- Write Program →p.112
- Exclusive Solo →p.113
- Copy VPM Oscillator →p.347
- Swap VPM Oscillators →p.347
- PAGE →p.126
- MODE →p.126

5-1g: Parameter Details

The Parameter Details area shows information for the selected item, including explanatory graphics and AMS modulation routings.

- Pitch LFO Modulation appears when any of the Pitch LFO parameters are selected.
- Portamento Modulation appears when any of the Portamento parameters are selected.
- VPM Oscillator 1-6 Carrier/Modulator Status appears when any of the Macro Edit parameters are selected.
- Noise Generator Modulation appears when any of the Noise Generator parameters are selected.
- EXi Audio Input Modulation appears when the EXi Audio Input Level parameter is selected.

5-2: PCM Osc



For more information about using PCM in the MOD-7, including hands-on tutorials, see “PCM as a VPM modulator” on page 306, and “Waveshaping” on page 306.

Overview

Disabling the PCM Oscillator

If the PCM Oscillator is not being used, you can disable it to save processing power. You can do this in two ways:

1. Set all MS Type parameters to Off, instead of Multisample.

or:

2. Make sure that the PCM Oscillator is not connected to anything else on the Patch Panel.

This includes both patch cable connections, and the normalised connections of the algorithm. If necessary, select a different algorithm in which the PCM Oscillator is not connected to anything else on the Patch Panel.

5-2a: Multisamples

Velocity splits

Each Oscillator has four velocity zones, named MS1 (High) through MS4 (Low). Each of these zones can play a different Multisample, and has separate settings for Level, Start Offset, and so on.

Note that, unlike the HD-1, crossfades and layers are not supported.

MS1 (High)

These are the settings for the first and highest velocity zone.

If you want to create a simple setup with only a single Multisample, just set up MS1 as desired, and then set the Bottom Velocity to 1.

Type

[Off, Multisample]

This selects whether MS1 will play a Multisample, or nothing at all. You can use this to disable any of the four Multisamples.

If all four MS are set to Off, the PCM Oscillator will be disabled entirely, saving processing power.

Bank

[List of Multisample Banks]

There are four types of Multisample Banks: ROM, SAMPLING mode, EXs, and User Sample Banks.

ROM Multisamples are the built-in “factory” sounds, and are always available.

Smp (SAMPLING Mode) Multisamples are the ones that you can see and edit in SAMPLING mode. After the abbreviation “Smp,” several different things may appear, as described below.

Smp: Old RAM means that this is an older Program pointing to the legacy “RAM” bank. Instead of pointing to a specific User Sample Bank, it will use whatever Multisample data is loaded into SAMPLING mode.

Smp: New Sampling Session will appear when there’s data in SAMPLING mode which hasn’t yet been saved to drive as a User Sample Bank. For instance, this might happen if you’ve loaded an old KSC file, loaded individual Samples or Multisamples, or recorded some new samples. Once the KSC is saved to drive, the name will update to show the file path (as described below).

Smp: [file name] will appear when a User Sample Bank has been loaded into SAMPLING mode. The name is the file name itself along with those of all its enclosing folders.

EXs Multisample banks are PCM expansion sets created especially for the NAUTILUS. Each has its own unique number; for instance, the ROM Expansion is EXs1. Only the currently loaded EXs banks will appear on this menu.

User Sample Banks bring the benefits of EXs to your own sample libraries. You can load and play gigabytes of your custom or converted samples at once, using Virtual Memory. The name is shown as a path to the KSC file, including the file name and the names of all enclosing directories. Only the currently loaded User Sample Banks will appear in this menu.

If a sound refers to a User Sample Bank which is not on the internal drive(s), the name will appear as “Unknown Sample Bank [number]” when the bank select dialog is open, shortened to “??[number]” when the dialog is closed.

For more information, see “User Sample Banks” on page 151 of the OG.

 Note that unlike the HD-1, you can only select mono Multisamples.

Multisample Select [List]

This parameter lets you select a Multisample for the velocity zone. You can use any mono Multisample, or the left or right channel of a stereo Multisample.

 Some Multisamples may have an upper limit to their keyboard range, over which they may not produce any sound.

Note: If the stored selection uses an EXs sample which is not currently loaded, it will not make any sound. The message “Samples Not Loaded” will also appear at the top of the display. To fix this, load the required EXs sample data.

Multisample Select menu

To select a Multisample:

1. Press the Multisample Select popup button to open the Multisample select menu.
2. Use the tabs to select a category and sub-category.
3. Select a Multisample from within that category/sub-category.
4. You can use the Find button to search for Multisamples by name.
For more information, see “Find dialog” on page 7.
5. Press the OK button to confirm your selection, or press the Cancel button to exit without making a change.

The list shows all of the mono Multisamples in the Bank. If the Bank contains stereo multisamples, you’ll also see the left and right channels as separate, mono multisamples, with -L and -R appended to the end of the name.

Reverse [Off, On]

This lets you play the selected multisample backwards, without looping.

Note: If the individual samples within a Multisample are already set to Reverse, they will still play in reverse, regardless of this setting.

Note: Reverse is not available for EXs or User Sample Bank Multisamples loaded using Virtual Memory. To use reverse with this data, set the Load Method to RAM. For more information, see “Change load method” on page 644.

On (checked): The Multisample will play back in reverse.

Off (unchecked): The Multisample will play back normally.

Level [0...127]

This sets the basic volume level of each multisample. Use this to adjust the balance between the four velocity zones.

 Depending on the multisample, high **Level** settings may cause distortion when playing many notes at a time. If this occurs, lower the **Level**.

With SAMPLING mode Multisamples, each Sample also has a **+12dB** option. If this is turned on, the Sample will play back approximately 12dB louder. You can configure this parameter for each Sample in SAMPLING mode. For more information, see “+12dB” on page 590.

Start Offset [Off, 1st...8th]

In addition to simply starting playback from the beginning, ROM and EXs Multisamples can have up to 8 different pre-programmed alternate starting points.

Similarly, SAMPLING mode and User Sample Bank Multisamples can play either from the beginning of the waveform, or from the loop start point.

Start Offsets: ROM and EXs

With ROM and EXs Multisamples, the Start Offset specifies whether to use the normal start point (**Off**), or to use one of the alternate start points (**1st–8th**).

Some ROM and EXs Multisamples may have fewer than 8 pre-programmed points, in which case only the available points can be selected.

Start Offsets: SAMPLING mode and User Sample Banks

With SAMPLING mode and User Sample Bank Multisamples, only **Off** and **1st** are available. **Off** uses the normal start point, and **1st** uses the loop start instead. **2nd** through **8th** will be grayed out.

Bottom Velocity [1...127]

This sets the lowest velocity at which the Multisample or will sound. MS1’s Bottom Velocity can be equal to, but not lower than, than that of MS2.

MS2 (Mid Hi), MS3 (Mid Lo), and MS4 (Low)

These are the settings for the second, third, and fourth velocity zones. The parameters for MS2 and MS3 are exactly the same as those for “MS1 (High),” above.

The parameters for MS4 are also similar to those for MS1, except that MS4 has no setting for Bottom Velocity (which is always fixed at 1).

5-2b: Velocity Zone

Velocity zone graphic

This is a graphic representation of the velocity zones for MS1-4. The currently selected MS is shown in green.

On [On, Off]

This mutes and un-mutes the PCM Oscillator, for quick comparisons during editing. This checkbox is also shown in the Parameter Details on the Patch Panel.

Note that the PCM Oscillator will still use processing power unless it is not connected on the Patch Panel, or all MS are set to **Off**. For more information, see “Disabling the PCM Oscillator” on page 320.

✓ 5-2: Page Menu Commands

- Compare →p.112
- Write Program →p.112
- Exclusive Solo →p.113
- Copy VPM Oscillator →p.347
- Swap VPM Oscillators →p.347
- Remap MS/Sample Banks →p.121
- PAGE →p.126
- MODE →p.126

5-3: PCM Mod

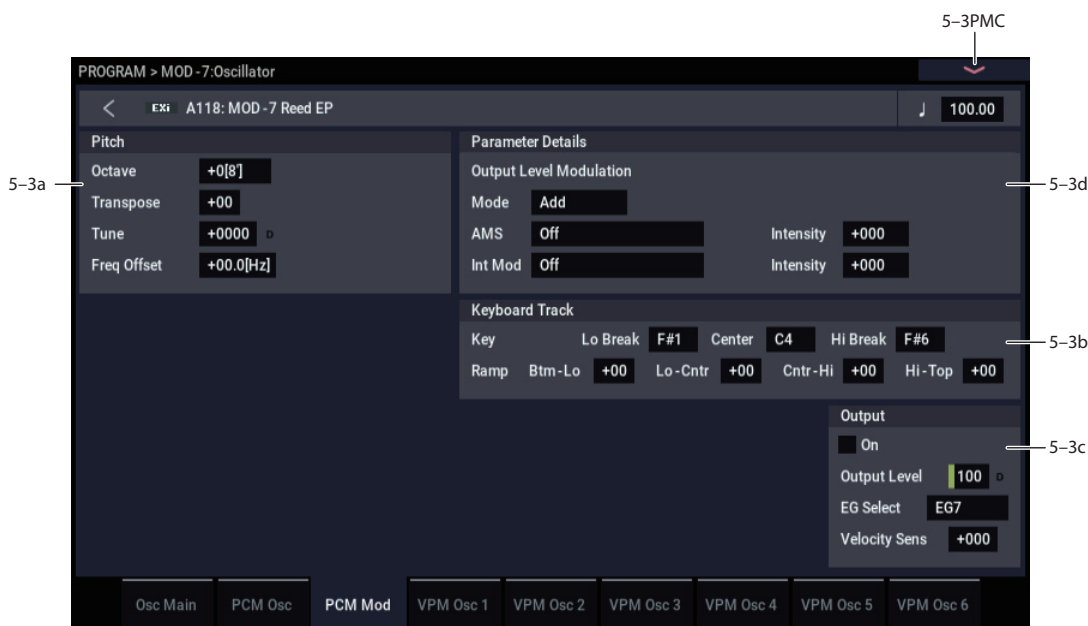

This page provides control of pitch and volume settings and modulation for the PCM Oscillator.

5-3a: Pitch

Octave [-2[32'], -1[16'], +0[8'], +1[4']]

This sets the basic pitch of the PCM Oscillator, in octaves. The default is +0[8'].

Transpose [-12...+12]

This adjusts the pitch in semitones, over a range of ±1 octave.

Tune [-1200...+1200]

This adjusts the pitch in cents, over a range of ±1 octave. A cent is 1/100 of a semitone.

Frequency Offset [-10.0Hz...+10.0Hz]

This adjusts the pitch by increments of 0.1 Hz. **Frequency Offset** is different from **Tune** in that, when used to detune the two oscillators, it can create a constant beat frequency across the range of the keyboard.

Pitch Parameter Details

These items appear in the Parameter Details area when any of the Pitch parameters are selected.

Use Common Mod [Checkbox]

When off, the oscillator still responds to the **Pitch** and **Portamento** settings from Pitch Common, but ignores the **LFO** and **AMS** settings.

AMS1 [List of AMS Sources]

This selects the first modulation source for controlling the oscillator’s pitch. For a list of AMS sources, see “Alternate Modulation Source (AMS) List” on page 903.

Intensity [-48.00...0.00...+48.00]

This controls the depth and direction of the AMS 1 pitch modulation, in semitones. To easily convert from semitones to FM ratios, see the table below.

| Ratio | Pitch in semitones |
|-------|---|
| 1 | Root pitch |
| 2 | +12.00 |
| 3 | +19.01 |
| 4 | +24.00 |
| 5 | +27.83 |
| 6 | +31.03 |
| 7 | +33.44 -- 2 octaves + minor seventh (-56 cents) |
| 8 | +36.00 |
| 9 | +38.09 -- 3 octaves + whole tone (+9 cents) |
| 10 | + 39.65 -- 3 octaves + major third (-35 cents) |
| 12 | +43.06 -- 3 octaves + fifth (+6 cents) |
| 15 | +46.50 -- 3 octaves + major seventh (-50 cents) |
| 16 | +48.00 |

AMS1 Int. Mod [List of AMS Sources]

You can modulate AMS 1's Intensity from another AMS source. This selects that source.

Intensity [-48.00...0.00...+48.00]

This controls the depth and direction of the Intensity Mod AMS, in semitones. The result is summed with the main AMS 1 Intensity to produce the final pitch modulation amount.

AMS2 [List of AMS Sources]

This selects a second modulation source for controlling the oscillator's pitch. For a list of AMS sources, see "Alternate Modulation Source (AMS) List" on page 903.

Intensity [-48.00...0.00...+48.00]

This controls the depth and direction of the AMS 2 pitch modulation, in semitones.

5-3b: Keyboard Track

The PCM Oscillator has its own keyboard tracking, which is dedicated to modulating the **Output Level** as you play up and down the keyboard. This can be especially convenient when using PCM as a modulator for a VPM Oscillator.

For more details on these parameters, see "5-4d: Keyboard Track" on page 331.

How it works: Keys and Ramps

The keyboard tracking works by creating four ramps, or slopes, between five keys on the keyboard. The bottom and top keys are fixed at the bottom and top of the MIDI range, respectively. You can set the other three keys—named **Low Break**, **Center**, and **High Break**—to be anywhere in between.

The four ramp values control the rate of change between each pair of keys. For instance, if the **Low-Center Ramp** is set to 0, the value will stay the same between the **Low Break** key and the **Center** key.

You can think of the resulting shape as being like two folding doors attached to a hinge in the center. At the **Center** key (the main hinge), the keyboard tracking has no effect.

The two folding doors swing out from this center point to create changes in the higher and lower ranges of the keyboard.

Key

Low Break [C-1...G9]

This sets the breakpoint note between the two lower ramps—the "hinge" of the lower door.

Center [C-1...G9]

This sets the center of the keyboard tracking—the main "hinge." At this key, the keyboard tracking has no effect on the volume, or on any AMS destinations.

High Break [C-1...G9]

This sets the breakpoint note between the two higher ramps—the "hinge" of the upper door.

Entering notes from the keyboard

You can enter note numbers directly by playing them on the keyboard. To do so:

1. Select one of the **Key** parameters.
2. Hold down the **ENTER** key.
3. While holding **ENTER**, play a note on the keyboard.

Ramp

Bottom-Low [-Inf, -99...+99, +Inf]

This sets the slope between the bottom of the MIDI note range and the **Low Break** key. For normal key track, use negative values.

Low-Center [-Inf, -99...+99, +Inf]

This sets the slope between the **Low Break** and **Center** keys. For normal key track, use negative values.

Center-High [-Inf, -99...+99, +Inf]

This sets the slope between the **Center** and **High Break** keys. For normal key track, use positive values.

High-Top [-Inf, -99...+99, +Inf]

This sets the slope between the **High Break** key and the top of the MIDI note range. For normal key track, use positive values.

| Ramp | Change in level |
|------|--------------------------|
| -Inf | Silent in one half-step |
| -99 | Silent in one whole-step |
| -95 | Silent in one octave |
| -48 | Silent in two octaves |
| -25 | Silent in four octaves |
| 00 | no change |
| +25 | x2 in four octaves |
| +50 | x2 in two octaves |
| +99 | x2 in one octave |
| +Inf | x2 in one half-step |

Keyboard Track Parameter Details

The **Keyboard Track** graphic appears in the Parameter Details area when any of the Keyboard Track parameters are selected.

5-3c: Output

These parameters control the overall volume of the PCM Oscillator.

On [Checkbox]

This mutes and un-mutes the entire oscillator, for quick comparisons during editing. This parameter is also shown in the Parameter Details on the Patch Panel.

Note that the oscillator will still use processing power unless either all MS are set to Off, or the PCM Oscillator is not connected to anything on the Patch Panel. For more information, see “Disabling the PCM Oscillator” on page 320.

Output Level [0...100]

This sets the basic output level of the VPM Oscillator. It is also shown in the Parameter Details on the Patch Panel.

EG Select [None, EG1...EG9, Amp EG]

This selects any of the 10 EGs to control the Oscillator’s output level. By default, EGs 1-6 are assigned to VPM Oscillators 1-6, EG7 is assigned to the PCM Oscillator, and EG8 is assigned to Filter A Cutoff.

None is the same as if the EG was always at its maximum level.

Velocity Sens [-100...+100]

This controls the degree to which output level responds to velocity. Negative settings are useful for creating velocity crossfades.

Output Level Parameter Details

These items appear in the Parameter Details area when any of the parameters in the Output section are selected. This includes **On**, **Output Level**, **EG Select**, and **Velocity Sens**.

AMS Mode [Add, Multiply]

To calculate the PCM Oscillator’s output volume, the main **Level** parameter, **Velocity Sens**, **Key Tracking**, and the selected **EG** are always multiplied together. If the value of any of these is at 0, none of the others has any effect. For instance, if the selected **EG** falls to 0, **Key Tracking** can’t bring the level back up again.

The **AMS Mode** parameter determines how AMS modulation (including Int Mod) interacts with these other modulators.

Add: AMS is added in after **Level**, **Velocity Sens**, **Key Tracking**, and the **EG** are multiplied together. This means that even if one of the main values is at 0, AMS can still bring up the volume to its maximum.

You can also think of this as having parallel modulation paths: EG, Key Track, and Velocity Sensitivity on one side, and AMS on the other.

Expressed mathematically, this is:
 $Volume = (Level * EG * Key Track * Vel Sens) + AMS.$

Multiply: This is the default, and is similar to the way that most other NAUTILUS Amp modulation works. AMS is multiplied along with all of the other modulators.

Expressed mathematically, this is:
 $Volume = Level * EG * Key Track * Vel Sens * (1 + AMS).$

AMS [List of AMS Sources]

This selects the main modulation source for controlling the **Output Level**. For a list of AMS sources, see “Alternate Modulation Source (AMS) List” on page 903.

Intensity [-100...+100]

This controls the depth and direction of the **Output Level** modulation.

AMS Int. Mod [List of AMS Sources]

You can modulate the AMS Intensity from another AMS source. This selects that source.

Intensity [-100...+100]

This controls the depth and direction of the Intensity Mod AMS. The result is summed with the main AMS 1 Intensity to produce the final **Output Level** modulation amount.

5-3d: Parameter Details

The Parameter Details area shows information for the selected item, including explanatory graphics and AMS modulation routings.

- Pitch Modulation appears when any of the Pitch parameters are selected.
- The **Keyboard Track** graphic appears in the Parameter Details area when any of the Keyboard Track parameters are selected.
- Output Level Modulation appears when any of the Output parameters are selected.

✓ 5-3: Page Menu Commands

- Compare →p.112
- Write Program →p.112
- Exclusive Solo →p.113
- Copy VPM Oscillator →p.347
- Swap VPM Oscillators →p.347
- PAGE →p.126
- MODE →p.126

5-4: VPM Osc1

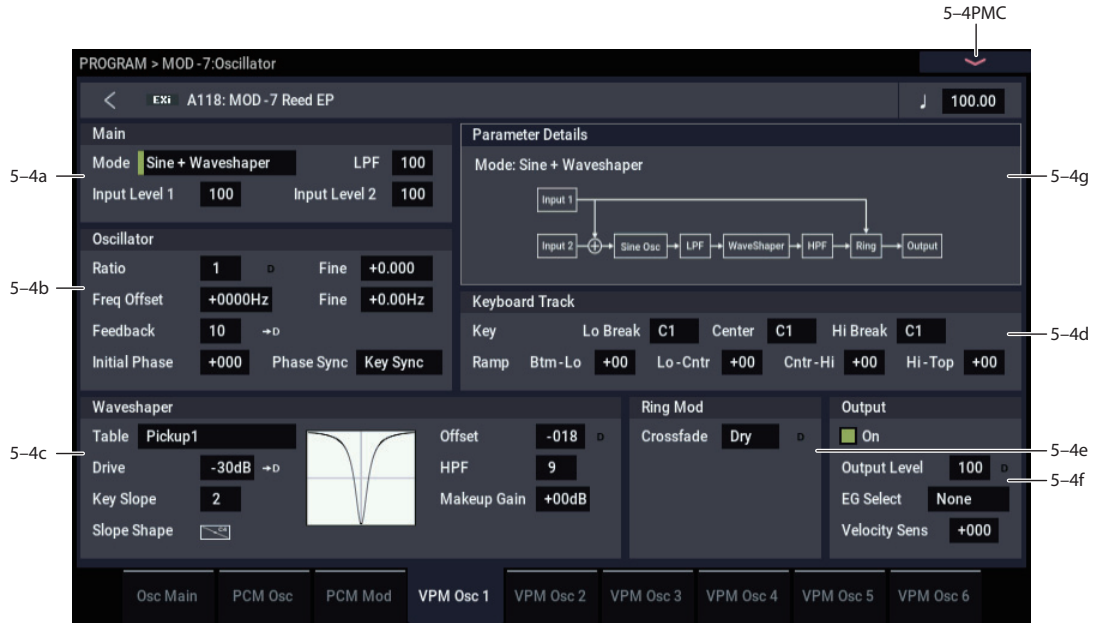

The six VPM Oscillators are the main tools of the MOD-7, and can be used in various ways for both generating waveforms and processing audio. For general information about these different possibilities, please see “Synthesis with the MOD-7: a guided tour” on page 301.

This page controls all aspects of the VPM Oscillator, including:

- Whether it will function as an oscillator on its own, or as a waveshaper or ring modulator for other signals
- All FM-related controls, including input levels, oscillator phase, feedback, and ratio, along with modulation for feedback and pitch
- All waveshaping-related controls, including table selection, drive, offset, keyboard slope, and modulation for drive and offset
- Ring mod crossfade modulation
- Output level and modulation, including keyboard tracking, EG selection, and velocity sensitivity

5-4a: Main

Mode [Off, Sine, Saw, Triangle, Square, Sine + Waveshaper, Waveshaper, Ring Mod Only]

This selects the basic functionality of the VPM Oscillator. Depending on the selected Mode, other parameters in the VPM Oscillator may be grayed out.

The Mode also affects the required processing power. **Triangle**, **Square**, and **Sine + Waveshaper** need the most power, and using them may result in slightly lower polyphony. **Off** requires no processing power at all.

Off: This completely disables the VPM Oscillator. If you’re not using the VPM Oscillator at all, set its **Mode** to **Off** in order to save processing power.

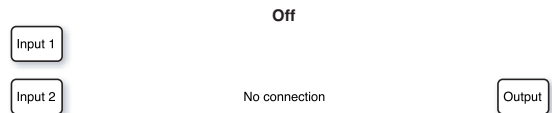

Sine: This includes a sine oscillator followed by a one-pole lowpass filter and a ring modulator. **Sine** is the default setting, used for classic FM sounds. Even when using more complex waveforms for FM Modulators, **Sine** is still the normal setting for an FM Carrier.

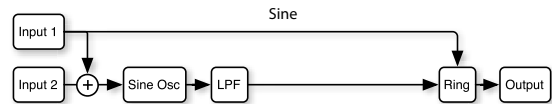

Saw: This mode uses FM feedback to create a sawtooth waveform. As with Sine, it includes a one-pole lowpass filter after the oscillator, as well as a ring modulator.



Triangle: This mode uses the oscillator to create a triangle waveform, followed by the ring modulator.

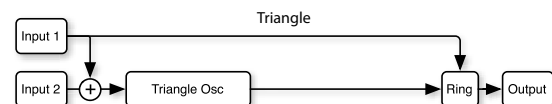

Square: This mode uses the oscillator to create a square waveform. There’s still a ring modulator before the output.

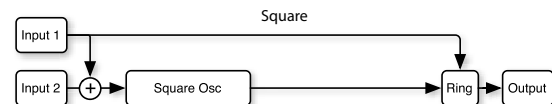

Sine + Waveshaper: This is the ultra-super-deluxe mode: sine oscillator, waveshaper, lowpass and highpass filters, and ring modulator. Three scoops, hot fudge sauce, whipped cream, chopped nuts, and a cherry on top.

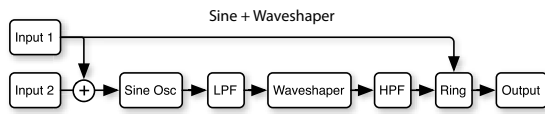

Waveshaper: This mode lets you use the waveshaper section to process signals from other sources, such as the other VPM Oscillators, the PCM Oscillator, the audio input, and so on. It includes a one-pole highpass filter after the waveshaper, followed by a ring modulator. Note that this setting disables the internal oscillator.

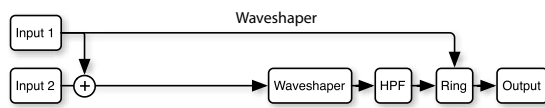

Ring Mod Only: In this mode, as the name implies, only the Ring Modulator is active. Input levels have no effect. Input 1 is the Modulator, and Input 2 is the Carrier.

Note: This setting disables the sine oscillator. Use this setting only if you want to use external signals for both the Modulator and the Carrier. If you want to use the internal sine oscillator as the Carrier, set **Mode** to **Sine** instead.

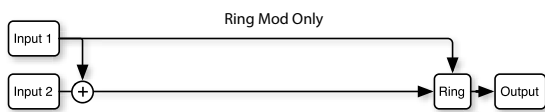

LPF [0...100]

This is a one-pole lowpass filter positioned directly after the Sine or Saw oscillators. It is available only when **Mode** is set to **Sine**, **Saw**, or **Sine + Waveshaper**.

Input Level 1 [0...100]

This sets the level for the first input. The level applies to both FM and Waveshaping, but it does not affect the direct path from Input 1 to the Ring Modulator.

When **Mode** is set to **Sine**, **Saw**, **Triangle**, **Square**, or **Sine + Waveshaper**, this controls the intensity of the FM from this input.

When **Mode** is set to **Waveshaper**, this controls the basic level going into the Waveshaper, which can be further controlled via the **Drive** parameter.

When **Mode** is set to **Ring Mod Only**, the input level has no effect.

Input Level 2 [0...100]

This sets the level for the second input, similar to “LPF,” above.

When **Mode** is set to **Ring Mod Only**, the input level has no effect.

Mode Parameter Details

A diagram of the selected **Mode**’s signal flow appears in the Parameter Details area when any of the Main parameters are selected.

5-4b: Oscillator

The Oscillator parameters do not apply when the Mode is set to **Off**, **Waveshaper**, or **Ring Mod Only**.

For more information about using the oscillator for VPM/FM, including hands-on tutorials, see “VPM (aka FM)” on page 303.

Ratio [0...64]

This sets the basic tuning for the oscillator. You can create in-between settings (including **0.5**) by using **Fine**, below.

0 means that the pitch will not change in response to the note number. For the classic DX “fixed frequency” effect, set both **Ratio** and **Ratio Fine** to **0**, and then set the **Frequency Offset** and **Frequency Fine** to the desired frequency. Note that with these settings, pitch modulation will have no effect.

1 produces the standard root pitch.

2 produces the first harmonic, **3** the second harmonic, and so on. For more information, see “VPM and FM Synthesis” on page 301.

Tip: Carrier Ratio near 0 produces chorusing

In an FM pair, setting the Carrier’s **Ratio** and **Frequency Offset** close to **0** reverses the normal relationship between the Carrier and the Modulator. In this case, the Modulator’s timbre comes through very clearly, while the Carrier provides only a chorusing effect. Use **Ratio Fine** and/or **Frequency Offset Fine** to control the speed and depth of the chorus.

(Ratio) Fine [-0.999...0...+0.999]

This allows you to fine-tune the ratio. You can think of this as the digits to the right of the decimal. For instance, setting the **Ratio** to **0** and **Fine** to **+0.500** results in an actual ratio of **0.5**, for a pitch one octave lower than standard.

Frequency Offset [-9999...0000...+9999Hz]

This produces a static frequency offset, in Hertz, from the pitch set by Ratio.

(Frequency) Fine [-0.99...+0.99 Hz]

This adjusts the **Frequency Offset** in 1/100 Hz increments.

Initial Phase [-180...0...+180]

This sets the initial phase of the oscillator. The relative phases of the carrier and modulator will affect the sound of FM modulation.

Tip: Try creating a simple FM pair, with the carrier’s **Ratio** set to 0, and the modulator’s **Ratio** set to 1. Set the carrier’s **Initial Phase** to +90, and then listen to how the sound changes when you move this up or down by a few degrees. The sound is similar to an electric piano.

Phase Sync [Key Sync, Random, Free Run]

Key Sync sets the oscillator to the **Initial Phase** value at every key down.

Random sets the oscillator to a random value, with the value randomized per oscillator. (This is the same as the AL-1 behavior for random.)

Free Run sets the oscillator to **Initial Phase** plus a random value that is the same for all of the EXi’s voices, and for all of the VPM Oscillators within those voices. For instance, if a Program has two MOD-7s, the voices for EXi1 would have

one random value, and those for EXi2 would have another. To get the vintage DX7 behavior, set oscillators to **Free Run** and set their phase to 0.

Feedback [0...100]

Feedback is a third FM input, hard-wired in one of two ways to the oscillator's own output, which allows the oscillator to modulate itself. The exact routing depends on the **Feedback Path** parameter; for more information, see "Feedback Path" on page 327.

Feedback is available only when **Mode** is set to **Sine** or **Sine + Waveshaper**.

With **Feedback Path** set to **From Sine Osc**, setting **Feedback** to 65 creates a reasonable approximation of a sawtooth waveform. Modulation of **Feedback** will then sound similar to modulating the cutoff frequency of a low-pass filter.

Pitch Parameter Details

These items appear in the Parameter Details area when **Ratio**, (**Ratio Fine**, **Freq Offset**, (**Freq Offset Fine**, **Initial Phase**, or **Phase Sync** are selected.

Note: When both **Ratio** and **Ratio Fine** are set to 0, pitch modulation will have no effect.

Use Common Mod [Checkbox]

On: The oscillator will respond to all of the pitch modulation from the Osc Main page. This the default.

Off: The oscillator will ignore the Osc Main page's **LFO** and **AMS** settings. It will still respond to the **Pitch** and **Portamento** settings, including **Pitch Slope**, **JS (+X)**, **JS(-X)**, and **Analog**. It will also respond to all pitch-related EXi Common parameters, such as **Chord** and **Scale**.

AMS1 [List of AMS Sources]

This selects the first modulation source for controlling the oscillator's pitch. For a list of AMS sources, see "Alternate Modulation Source (AMS) List" on page 903.

Intensity [-48.00...0.00...+48.00]

This controls the depth and direction of the AMS 1 pitch modulation, in semitones. To easily convert from semitones to FM ratios, see the table below.

| Ratio | Pitch in semitones |
|-------|---|
| 1 | Root pitch |
| 2 | +12.00 |
| 3 | +19.01 |
| 4 | +24.00 |
| 5 | +27.83 |
| 6 | +31.03 |
| 7 | +33.44 -- 2 octaves + minor seventh (-56 cents) |
| 8 | +36.00 |
| 9 | +38.09 -- 3 octaves + whole tone (+9 cents) |
| 10 | + 39.65 -- 3 octaves + major third (-35 cents) |
| 12 | +43.06 -- 3 octaves + fifth (+6 cents) |
| 15 | +46.50 -- 3 octaves + major seventh (-50 cents) |
| 16 | +48.00 |

AMS1 Int. Mod [List of AMS Sources]

You can modulate AMS 1's Intensity from another AMS source. This selects that source.

Intensity [-48.00...0.00...+48.00]

This controls the depth and direction of the Intensity Mod AMS, in semitones. The result is summed with the main AMS 1 Intensity to produce the final pitch modulation amount.

AMS2 [List of AMS Sources]

This selects a second modulation source for controlling the oscillator's pitch. For a list of AMS sources, see "Alternate Modulation Source (AMS) List" on page 903.

Intensity [-48.00...0.00...+48.00]

This controls the depth and direction of the AMS 2 pitch modulation, in semitones.

Feedback Parameter Details

These items appear in the Parameter Details area when **Feedback** is selected.

Feedback Path [From Sine Osc, From Output]

This controls the source of the **Feedback** signal.

From Sine Osc routes the feedback directly from the output of the Sine Oscillator. The rest of the VPM Oscillator signal chain, including the LPF, HPF, waveshaper, ring modulator, and output volume control, will not affect the feedback. Use this option when you want the feedback timbre to be independent from the output volume.

From Output routes the feedback from the output of the entire VPM Oscillator signal chain. When the Oscillator Mode is set to Sine, this produces the feedback structure of classic FM synths.

Feedback Path

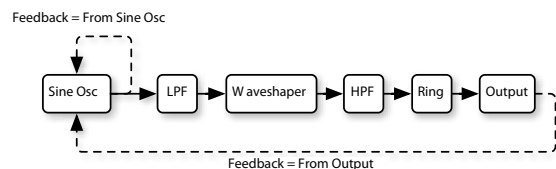

AMS [List of AMS Sources]

This selects an AMS source to control the **Feedback**. For a list of AMS sources, see "Alternate Modulation Source (AMS) List" on page 903.

Intensity [-100...+100]

This controls the depth and direction of the AMS modulation for **Feedback**.

5-4c: Waveshaper

This section is available only when the **Mode** is set to **Sine + Waveshaper** or **Waveshaper**.

Note that, if the same oscillator is using both FM and waveshaping, they occur in that order: first the sine oscillator is modulated by the inputs, and then the result is waveshaped.

For more information about using the waveshaper, including hands-on tutorials, see “Waveshaping” on page 306.

Table [List of tables]

This selects the table used by the waveshaper. The waveshaping effect will be a combination of the input signal (including both the waveform and the signal level), the selected table, and the settings for **Drive** and **Offset**.

Linear, Sine->Tri, and Step

Linear: This simple table does not alter the signal, as long as levels are within the range of the table. Extremely high input levels, or **Drive** settings over 0dB, may still cause clipping. Non-zero values of **Offset** may also cause clipping on either the positive or negative side, changing the waveform’s symmetry.

Sine->Tri: With full-scale sine input, this table creates a triangle waveform. If you just want to create a triangle waveform, setting the **Mode** to **Triangle** will work a little better, but this table allows you to use **Drive** and **Offset** in creative ways.

For a basic triangle waveform, set the **Key Slope** to 1, and set the **Key Slope Mode** to roll off only above C4. For more mellow, sine-like tones, reduce the **Drive**; for sharper timbres, increase it.

Step: This table creates soft clipping. Increasing the input level and/or **Drive** creates harder clipping.

With a full-scale sine wave, the output is something like a soft square wave, with **Offset** being similar to pulse width.

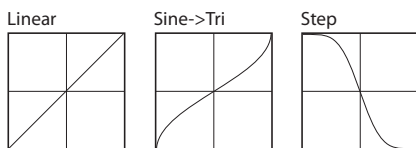

Sines

With sine wave input, these tables produce output similar to a simple FM pair with the Carrier:Modulator ratio set to 0:1. **Drive** functions like the FM input level, and responds well to AMS modulation. With full-scale input, **Drive** settings over 0dB will cause clipping.

The tables differ only in their maximum brightness. **Sine4** is the brightest, for the broadest range of timbres. **Sine2** is darker, and **Sine** is darker still; these offer finer control with **Drive** modulation, for more subtle coloration.

Sine4: When **Drive** is at 0dB, this table is like 0:1 FM with the carrier level at maximum. To produce a similar effect to **Sine2**, reduce the **Drive** by 6dB; to produce a similar effect to **Sine**, reduce the **Drive** by 12dB.

Sine and **Sine2:** These are darker versions of **Sine4**.

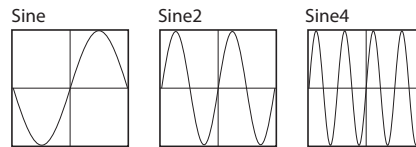

Pickups

These tables simulate electromagnetic pickups, such as those of an electric piano. **Drive** functions as the signal gain.

To create electric piano sounds, use a sine wave as input, and assign an EG to modulate **Drive**; it should be around 0dB at first, and then decay exponentially to a very low value.

Offset controls the distance between the pickup and the center of the tine; typically, values close to 0 will work well.

Pickup1: This simulates a bright electromagnetic pickup.

Pickup2: This creates a different amount of saturation; its tone is slightly darker than Pickup1.

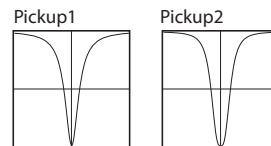

Tanh

Tanh2, 4, and 8: These create soft clipping, similar to the **Step**. Vary the **Drive** to control the amount of distortion. 2, 4, and 8 produce increasing amounts of clipping. Full-scale sine wave input will produce output similar to a soft-edged square wave.

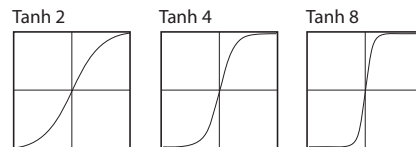

Additive

While the Additive tables can produce interesting results with any input signal, they produce the described results only with a full-scale sine wave. Reducing the **Drive** (or the level of the sine wave input) will diminish the level of the additive harmonics, making the result sound more like the original sine. Dynamic modulation of **Drive** may sound similar to a filter opening and closing.

Add Saw 3Harm: This produces the first three harmonics of a sawtooth.

Add Square 3Harm: This produces the first three harmonics of a square wave.

Add Tri 3Harm: This produces the first three harmonics of a triangle wave.

Add 12345: This produces harmonics 1 through 5 with equal amplitude, similar to a filtered pulse waveform.

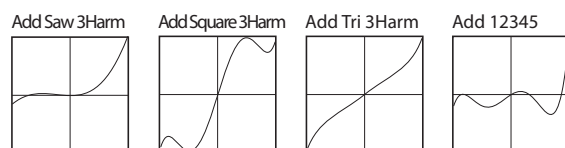

Add 1Plus2: This produces the fundamental plus the 2nd harmonic at equal amplitude, and sounds like an 8th + 4th organ stop.

Add 1Plus3: This produces the fundamental plus the 3rd harmonic at equal amplitude, and sounds like an 8' + 2 2/3' organ stop.

Add 1Plus4: This produces the fundamental plus the 4th harmonic at equal amplitude, and sounds like an 8' + 2' organ stop.

Add 1Plus5: This produces the fundamental plus the 5th harmonic at equal amplitude, and sounds like an 8' + 1 3/5' organ stop.

Add 1Plus6: This produces the fundamental plus the 6th harmonic at equal amplitude, and sounds like an 8' + 1 1/3' organ stop.

Add 1Plus7: This produces the fundamental plus the 7th harmonic at equal amplitude.

Add 1Plus8: This produces the fundamental plus the 8th harmonic at equal amplitude, and sounds like an 8' + 1' organ stop.

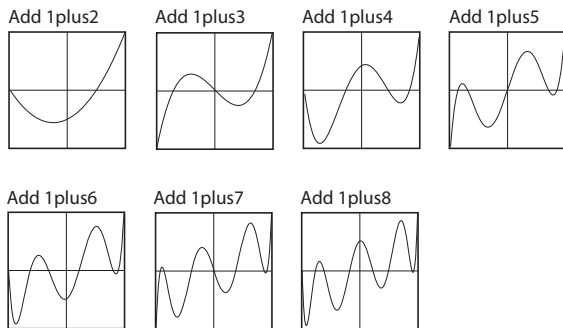

Multipliers

Sine Octave: With full-scale sine input, this produces a sine wave one octave higher than the input, and clips above 0 dB.

Sine 2Octave: With full-scale sine input, this produces a sine wave two octaves higher than the input signal. With decreasing **Drive** settings, it jumps down to the original octave—producing an interesting effect when **Drive** is modulated. More complex input signals can also produce good results.

Triangle4: This is similar to **Sine4**, except that it uses a triangle shape. It produces output similar to a simple FM pair with the Carrier:Modulator ratio set to 0:1, and the carrier set to a triangle wave. **Drive** functions like the FM input level, and responds well to AMS modulation. With full-scale input, **Drive** settings over 0dB will cause clipping.

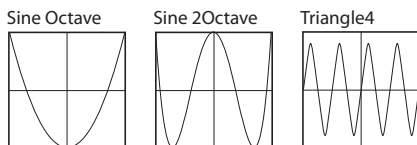

TX Waves

TX Wave 2, 3, 4, 7, and 8: With full-scale sine input, these produce waveforms similar to those of classic 4-operator FM synths. Modulate **Drive** below 0dB for a more sine-like sound.

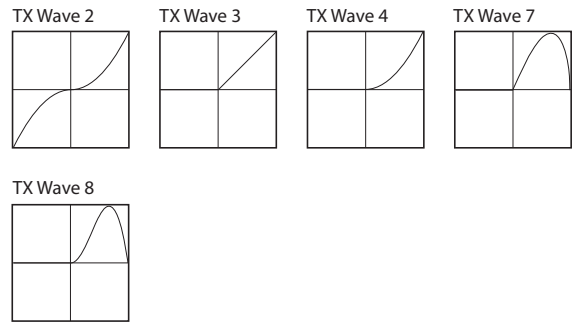

Tube and Diode

Tube: This is a soft-clipping table, for simulating analog saturation. The combination of input level and **Drive** controls the amount of clipping; **Offset** controls symmetry, like DC offset into a VCA.

Diode 1 and 2: These produce asymmetric soft-clipping, like an analog diode. **Diode 2** produces more distortion than **Diode 1**.

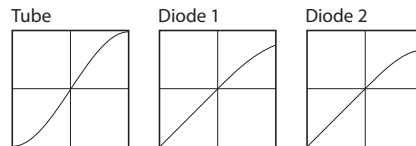

Mixture

Mixture 1, 2, 3, and 4: With sine wave input, these four tables create a bunch of different harmonics at different amplitudes, like FM or organ stops.

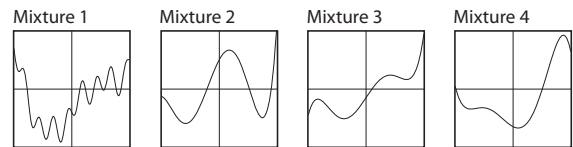

Invert

Invert: This table simply inverts the input signal. It can be used to invert a waveform prior to adding it back to itself—for pulse width modulation, for example.

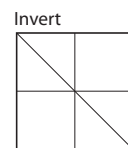

Fuzzy

Fuzzy: This table adds random-sounding noise to the input, even with low input levels. Modulating **Drive** can produce interesting, grungy effects.

Fuzzy Tube: This is similar to **Fuzzy**, above, with the addition of soft clipping.

Get Fuzzy: This unusual table is noisy only around zero. High-level input signals (or high **Drive** settings) will produce less noisy output, while low-level signals will be much more noisy.

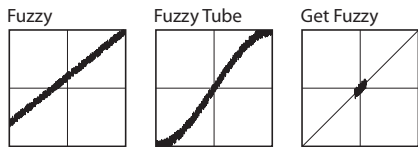

01/W and Waveshaper Effect tables

The rest of the tables are based on those of the classic Korg 01/W and the Waveshaper effect.

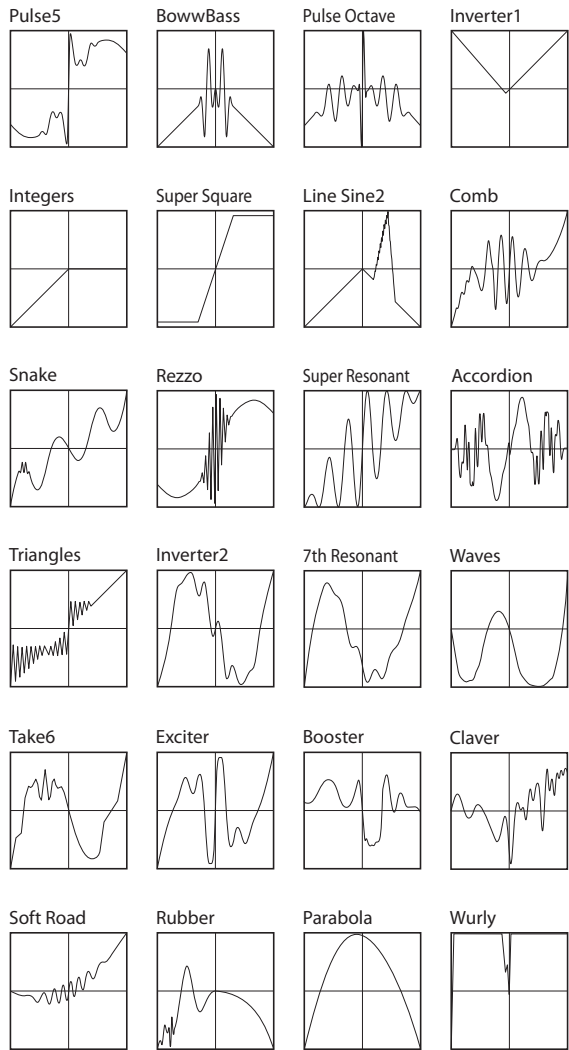
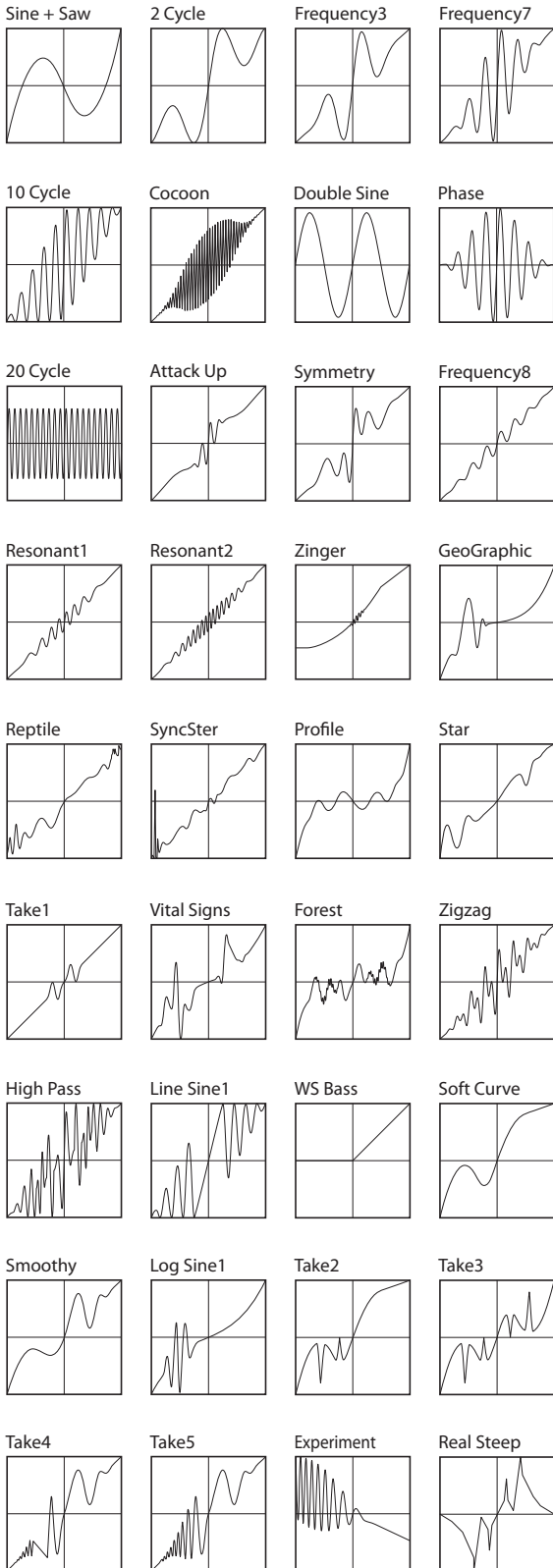

Drive [-36dB...0dB...+36dB]

This sets the volume of the signal going into waveshaper. By reducing the **Drive**, you can make the signal interact with only part of the table. This is particularly useful in combination with **Offset**, as shown in the diagram below.

Drive can also be modulated to create changes in timbre, as described under “Tip: Modulating Drive,” below.

With a pure sine oscillator, anything greater than 0dB will clip. Often, clipping will sound bad—but some tables, such as **tanh**, **step**, **tube** and **diode**, are specifically made for clipping. With these tables, the harder you drive, the more saturation/overdrive you’ll get.

Drive and Offset

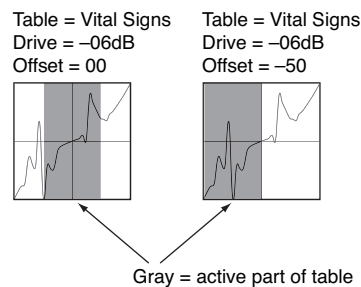

Key Slope [0...75]

This scales the amount of **Drive** as you move up and down the keyboard, with a center point of C4. **Key Slope** can help to keep the timbre even across the keyboard, and also help to minimize aliasing. The **Slope Shape** parameter, below, affects how this parameter works.

The steps are in increments of 0.2dB per octave, up to a maximum of 15dB/oct.

Slope Shape [graphics: symmetric, high range only]

Key Slope always attenuates **Drive** above C4. This parameter selects whether or not it also *boosts Drive below* C4.

Offset [0...100]

This introduces a DC Offset into the input signal, shifting the signal in relation to the waveshaper table.

With a full-scale input signal, this will make the signal clip on one side or the other, and result in an asymmetric waveform. When used in conjunction with **Drive**, it can select the part of the table used to process the signal. **Offset** can be modulated at note-on, which works well with AMS sources such as Velocity and Exponential Velocity.

Offset also has specific uses with particular tables; see the individual table descriptions for more information.

For more information, see the diagram “Drive and Offset,” above.

HPF [0...100]

The output of the waveshaper is processed through a simple highpass filter. This filter is primarily intended to prevent DC offsets in the waveshaped signal, which can cause unexpected clipping at the audio outputs, along with other strange results.

This parameter controls the cutoff of the filter. The default value of **5** is generally sufficient to block DC offsets. Higher values will make the sound increasingly thin, which may be useful for creative purposes.

Makeup Gain [-36dB...0dB...+36dB]

This provides additional gain to compensate for loss through the Waveshaper. For information on how to use this, see “Tip: Modulating Drive,” below.

Drive Parameter Details

These items appear in the Parameter Details area when any of the parameters in the Waveshaper section other than **Offset** are selected. This includes **Table**, **Drive**, **Key Slope**, **Slope Shape**, **HPF**, and **Makeup Gain**.

AMS [List of AMS Sources]

This selects an AMS source to control the **Drive**. For a list of AMS sources, see “Alternate Modulation Source (AMS) List” on page 903.

Intensity [-72dB...+72dB]

This controls the depth and direction of the **Drive** modulation.

Tip: Modulating Drive

Modulating **Drive** can be extremely useful for creating dynamic timbres. Depending on the selected table, this modulation will also often cause significant changes in

overall level. You can compensate for this with a combination of **Makeup Gain** and **Output Level** modulation:

1. **Set up an AMS source to modulate Drive.**
2. **Assign the same AMS source to modulate the main Output Level, inversely from Drive.**

In other words, if you use a positive intensity for Drive AMS, use a negative intensity for Output Level AMS.

3. **Adjust the Output Level AMS Intensity until the volume level stays sufficiently even.**

The actual settings will vary depending on the input level and the selected table. Don't expect the **Output Level** intensity to be the same as that of **Drive**.

4. **Increase the Waveshaper's Makeup Gain parameter to compensate for the reduction in volume.**

Offset Parameter Details

These items appear in the Parameter Details area when the Waveshaper **Offset** parameter is selected.

AMS [List of AMS Sources]

This selects an AMS source to control the **Offset**. For a list of AMS sources, see “Alternate Modulation Source (AMS) List” on page 903.

Offset can be modulated at note-on only. This works well with AMS sources such as Velocity and Exponential Velocity.

Intensity [-100...+100]

This controls the depth and direction of the AMS modulation for **Offset**.

5-4d: Keyboard Track

Each VPM Oscillator has its own keyboard tracking, which is dedicated to modulating the **Output Level** as you play up and down the keyboard.

NAUTILUS's keyboard tracking can be fairly complex, if desired. You can create different rates of change over up to four different parts of the keyboard.

Tracking for timbre

Most acoustic instruments change in timbre as you play higher or lower pitches. At its most basic, keyboard tracking can compensate for these effects by adjusting the output level of an FM Modulator as you play higher and lower on the keyboard. With Modulators, raising the level will make the timbre brighter; reducing the level will make it darker.

Tracking for aliasing

With FM, aliasing generally increases at higher frequencies (see “Aliasing” on page 301). Reducing Modulator levels at higher pitches is usually the most effective way to minimize aliasing.

How it works: Keys and Ramps

The keyboard tracking works by creating four ramps, or slopes, between five keys on the keyboard. The bottom and top keys are fixed at the bottom and top of the MIDI range, respectively. You can set the other three keys—named **Low Break**, **Center**, and **High Break**—to be anywhere in between.

The four ramp values control the rate of change between each pair of keys. For instance, if the **Low-Center** Ramp is set to 0, the value will stay the same between the **Low Break** key and the **Center** key.

You can think of the resulting shape as being like two folding doors attached to a hinge in the center. At the **Center** key (the main hinge), the keyboard tracking has no effect. The two folding doors swing out from this center point to create changes in the higher and lower ranges of the keyboard.

Key

Low Break [C-1...G9]

This sets the breakpoint note between the two lower ramps—the “hinge” of the lower door.

Center [C-1...G9]

This sets the center of the keyboard tracking—the main “hinge.” At this key, the keyboard tracking has no effect on the volume, or on any AMS destinations.

High Break [C-1...G9]

This sets the breakpoint note between the two higher ramps—the “hinge” of the upper door.

Entering notes from the keyboard

You can enter note numbers directly by playing them on the keyboard. To do so:

1. **Select one of the Key parameters.**
2. **Hold down the ENTER key.**
3. **While holding ENTER, play a note on the keyboard.**

Ramp

Positive ramp values mean that the keyboard tracking output increases as you play farther from the **Center** key; negative ramp values mean that it decreases.

Because of this, the meanings of positive and negative ramp settings will change depending on whether the ramp is to the left or right of the **Center** key.

Also note that, as shown in the graphic “Amp Keyboard Tracking,” below, negative slopes are more steep than positive slopes.

Bottom-Low and Low-Center: negative ramps make the keyboard tracking’s output go down as you play lower on the keyboard, and positive ramps make the output go higher.

Center-High and High-Top: negative ramps make the keyboard tracking’s output go down as you play *higher* on the keyboard, and positive ramps make the output go up.

Bottom-Low [-Inf, -99...+99, +Inf]

This sets the slope between the bottom of the MIDI note range and the **Low Break** key. For normal key track, use negative values.

Low-Center [-Inf, -99...+99, +Inf]

This sets the slope between the **Low Break** and **Center** keys. For normal key track, use negative values.

Center-High [-Inf, -99...+99, +Inf]

This sets the slope between the **Center** and **High Break** keys. For normal key track, use positive values.

High-Top [-Inf, -99...+99, +Inf]

This sets the slope between the **High Break** key and the top of the MIDI note range. For normal key track, use positive values.

| Ramp | Change in level |
|------|--------------------------|
| -Inf | Silent in one half-step |
| -99 | Silent in one whole-step |
| -95 | Silent in one octave |
| -48 | Silent in two octaves |
| -25 | Silent in four octaves |
| 00 | no change |
| +25 | x2 in four octaves |
| +50 | x2 in two octaves |
| +99 | x2 in one octave |
| +Inf | x2 in one half-step |

+Inf and -Inf ramps

+Inf and **-Inf** are special settings which create abrupt changes for split-like effects. When a ramp is set to **+Inf** or **-Inf**, the keyboard tracking will go to its extreme highest or lowest value over the span of a single key.

When a ramp is set to **+Inf**, the keyboard tracking will go to its highest value (double the programmed volume) over a single half-step.

Similarly, when a ramp is set to **-Inf**, the keyboard tracking will go to its lowest value (complete silence) over a single half-step.

Note: If you set the **Center-High** ramp to **+Inf** or **-Inf**, the **High-Top** parameter will be grayed out. Similarly, if you set the **Low-Center** ramp to **+Inf** or **-Inf**, the **Bottom-Low** ramp will be grayed out.

Keyboard Track Parameter Details

The **Keyboard Track** graphic appears in the Parameter Details area when any of the Keyboard Track parameters are selected.

Amp Keyboard Tracking

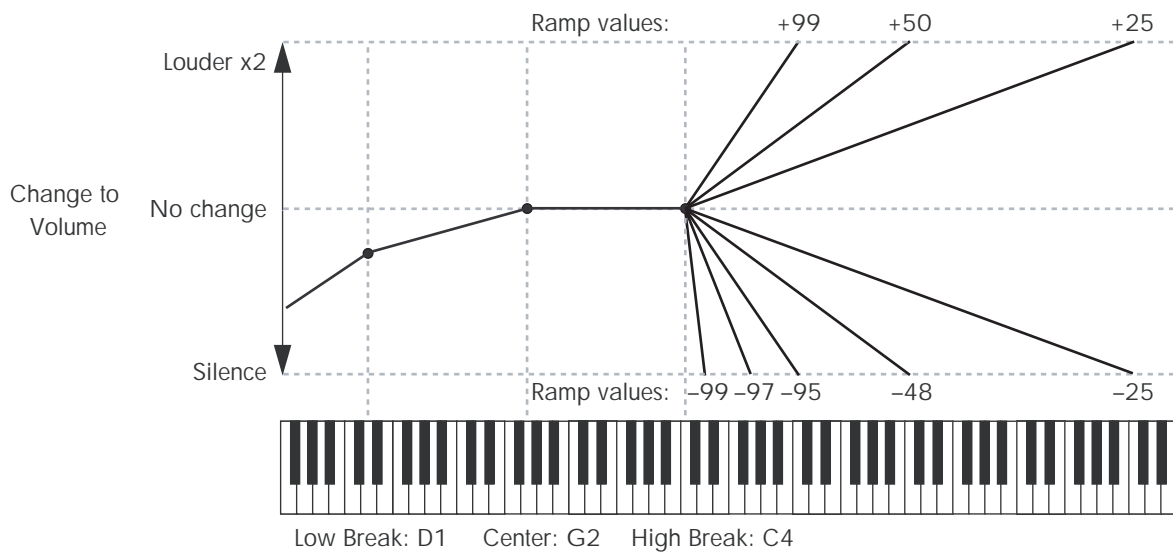

5-4e: Ring Modulator

Ring modulation adds new frequencies to the audio by multiplying one input, called the Carrier, by another, the Modulator.

In general, if the frequencies of the Carrier and Modulator are harmonically related, these new, added frequencies create brighter timbres. The brighter the inputs, the more new frequencies are created, and the greater the effect. Small amounts of detuning between the Carrier and Modulator produce more motion and richness in the output.

If the Carrier and Modulator frequencies are not related (by using lots of detune or frequency offset on one of them, for instance), the ring modulator creates dissonant, gong-like tones.

In the MOD-7, Input 1 always acts as the Modulator; it has a direct path into the ring modulator, which is not affected by the **Input Level** control. Depending on the selected VPM Oscillator **Mode**, the Carrier can be either the VPM Oscillator itself (after all applicable FM and waveshaping), or Input 2.

When **Mode** is set to **Waveshaper**, Input 2 is waveshaped before entering the ring modulator. There are many possibilities here, but two simple tables may be particularly useful: **Inverter1** creates a rectified signal, and **Integers** clips the signal to negative values only.

🔊 As with FM, ring modulation can produce aliasing—especially at higher frequencies.

For more information about using the ring modulator, including hands-on tutorials, see “Ring Modulation” on page 309.

Crossfade

[Dry, 1:99...49:51, AM, 51:49...1:99, Wet]

This crossfades between the dry and ring-modulated signal. The center value, with equal amounts of wet and dry, produces AM (Amplitude Modulation). You can modulate this value in real-time, as described under “Crossfade Parameter Details,” below

More details on ring modulation

In the most simple case, when both the Carrier and Modulator are sine waves, ring modulation produces two new frequencies. These new frequencies are called sidebands.

One is the “sum,” at the Carrier frequency *plus* the Modulator frequency. The other is the “difference,” at the Carrier frequency *minus* the Modulator frequency.

For instance, let’s say that Carrier is a 1,000Hz sine wave, and the Modulator is a 300Hz sine wave. The two sidebands would be at 1,300Hz (the sum) and 700Hz (the difference).

Notice that neither of these sidebands has a simple musical or harmonic relationship to the original tones. This is why the output can sound like a gong, with clangorous and dissonant overtones.

If the Modulator’s frequency is higher than that of the Carrier, the difference sideband is reflected around 0Hz, with a 180 degree phase shift. For instance, if the Carrier is at 100Hz and the Modulator is at 400Hz, the difference sideband would be 300Hz, 180 degrees out of phase.

The effect becomes much more complex when using inputs other than pure sine waves, since separate sum and difference tones are created for each component frequency in each input.

For instance, let’s say that the Carrier now has two sine waves, at 1000Hz and 2000Hz respectively, and that the Modulator also has two sine waves, at 300Hz and 600Hz. The output of the ring modulator would then include eight different sidebands:

- 1,300Hz (1,000Hz+300Hz)
- 1,600Hz (1,000Hz+600Hz)
- 700Hz (1,000Hz–300Hz)
- 400Hz (1,000Hz–600Hz)
- 2,300Hz (2,000Hz+300Hz)
- 2,600Hz (2,000Hz+600Hz)
- 1700Hz (2,000Hz–300Hz)
- 1400Hz (2,000Hz–600Hz)

If both inputs contain three frequencies each, the number of sidebands grows to 18; if they contain four frequencies each, it grows to 32; with five each, the sidebands grow to 50. So, the effect can become very complicated, very fast!

(If the Carrier and Modulator are harmonically related, the frequencies of some of the sidebands may be the same, resulting in a somewhat simpler tone.)

If one or more sum frequencies are higher than 24kHz (half of the sample rate), this will cause aliasing. Aliasing adds its own sidebands, which may or may not enhance the effect of the ring modulator. If you want to minimize aliasing, avoid using bright tones for both the Carrier and Modulator simultaneously. If one of the sounds is very bright, consider using a dark, lowpassed sound for the other.

Crossfade Parameter Details

These items appear in the Parameter Details area when the Ring Modulator **Crossfade** parameter is selected.

AMS [List of AMS Sources]

This selects an AMS source to control the **Crossfade**. For a list of AMS sources, see “Alternate Modulation Source (AMS) List” on page 903.

Intensity [-100...+100]

This controls the depth and direction of the AMS modulation for **Crossfade**.

5-4f: Output

On [Checkbox]

This mutes and un-mutes the entire VPM Oscillator, for quick comparisons during editing. This parameter is also shown in the Parameter Details on the Patch Panel.

Note that the Oscillator will still use processing power unless the **Mode** is set to **Off**.

Output Level [0...100]

This sets the basic output level of the VPM Oscillator. It is also shown in the Parameter Details on the Patch Panel.

If the Oscillator is an FM Modulator, the output level affects the brightness of its associated Carrier(s). If the Oscillator is an FM Carrier, the output level affects volume.

EG Select [None, EG1...EG9, Amp EG]

This selects any of the 10 EGs to control the Oscillator’s output level. By default, EGs 1-6 are assigned to VPM Oscillators 1-6, EG7 is assigned to the PCM Oscillator, and EG8 is assigned to Filter A **Cutoff**.

None is the same as if the EG was always at its maximum level.

Velocity Sens [-100...+100]

This controls the degree to which output level responds to velocity. Negative settings are useful for creating velocity crossfades between two sets of VPM Oscillators.

Output Level Parameter Details

These items appear in the Parameter Details area when any of the parameters in the Output section are selected. This includes **On**, **Output Level**, **EG Select**, and **Velocity Sens**.

AMS Mode [Add, Multiply]

To calculate the VPM Oscillator’s output volume, the main **Level** parameter, **Velocity Sens**, **Key Tracking**, and the selected **EG** are always multiplied together. If the value of any of these is at 0, none of the others has any effect. For instance, if the selected **EG** falls to 0, **Key Tracking** can’t bring the level back up again.

The **AMS Mode** parameter determines how AMS modulation (including Int Mod) interacts with these other modulators.

Add: AMS is added in after **Level**, **Velocity Sens**, **Key Tracking**, and the **EG** are multiplied together. This means that even if one of the main values is at 0, AMS can still bring up the volume to its maximum.

You can also think of this as having parallel modulation paths: EG, Key Track, and Velocity Sensitivity on one side, and AMS on the other.

Expressed mathematically, this is:

$$\text{Volume} = (\text{Level} * \text{EG} * \text{Key Track} * \text{Vel Sens}) + \text{AMS}$$

Multiply: This is the default, and is similar to the way that most other NAUTILUS Amp modulation works. AMS is multiplied along with all of the other modulators.

Expressed mathematically, this is:

$$\text{Volume} = \text{Level} * \text{EG} * \text{Key Track} * \text{Vel Sens} * (1 + \text{AMS})$$

AMS [List of AMS Sources]

This selects the main modulation source for controlling the **Output Level**. For a list of AMS sources, see “Alternate Modulation Source (AMS) List” on page 903.

Intensity [-100...+100]

This controls the depth and direction of the **Output Level** modulation.

AMS Int. Mod [List of AMS Sources]

You can modulate the AMS Intensity from another AMS source. This selects that source.

Intensity [-100...+100]

This controls the depth and direction of the Intensity Mod AMS. The result is summed with the main AMS 1 Intensity to produce the final **Output Level** modulation amount.

5-4g: Parameter Details

The Parameter Details area shows information for the selected item, including explanatory graphics and AMS modulation routings.

- The Mode graphic appears when any of the parameters in the Main section are selected.
- Pitch Modulation appears when **Ratio**, (Ratio) **Fine**, **Freq Offset**, (Freq Offset) **Fine**, **Initial Phase**, or **Phase Sync** are selected.
- Feedback Modulation appears when **Feedback** is selected.
- Drive Modulation appears when any of the parameters in the Waveshaper section other than **Offset** are selected. This includes **Table**, **Drive**, **Key Slope**, **Slope Shape**, **HPF**, and **Makeup Gain**.
- Offset Modulation appears when the Waveshaper **Offset** parameter is selected.

- The Keyboard Track graphic appears when any of the parameters in the Keyboard Track section are selected.
- Crossfade Modulation appears when (Ring Mod) **Crossfade** is selected.
- Output Level Modulation appears when any of the parameters in the Output section are selected.

✓ 5-4: Page Menu Commands

- Compare →p.112
- Write Program →p.112
- Exclusive Solo →p.113
- Copy VPM Oscillator →p.347
- Swap VPM Oscillators →p.347

- PAGE →p.126
- MODE →p.126

5-5: VPM Osc 2

5-6: VPM Osc 3

5-7: VPM Osc 4

5-8: VPM Osc 5

5-9: VPM Osc 6

VPM Oscillators 2 through 6 are identical to VPM Oscillator 1. For detailed parameter explanations, please see “5-4: VPM Osc1” on page 325.

PROGRAM > MOD-7: Filter

6-1: Basic

Overview

The MOD-7 includes dual multimode resonant filters, including Korg's Multifilter. These filters are almost identical to those of the AL-1, except for the following:

- There is no **Trim** parameter. (This was unnecessary even in the AL-1, since the filter will not clip internally.) Output volume is still available and modulatable.
- The patch panel allows individual access to Filters A and B, and so the **Routing** parameter provides only **Parallel** and **4-Pole** modes. You can create serial routing using the patch panel, if desired.
- Similarly, since Filters A and B have independent outputs which can be routed separately to the Output Mixer, there are no filter-specific Pan or Pan AMS

controls. The Output Mixer supports modulatable Pan for all 6 inputs.

For detailed descriptions of the filter parameters, see "5-1: Basic" on page 154.

For information about using the filters in the MOD-7, including hands-on tutorials, see "Filtered VPM" on page 305.

Filters and the Analog parameter

When the Oscillator Main page **Analog** parameter is greater than 0, Filters A and B each get a different random detune value (including when **Link** is set to On).

If you want the two filters to be perfectly in tune, turn **Analog** to 0.

6-2: Multi Filter

The Multi Filter is identical to that of the AL-1. For detailed information, see "5-2: Multi Filter" on page 157.

6-3: Filter Mod.

The Filter Modulation page is almost identical to that of the AL-1. For detailed information, see "5-3: Filter Mod." on page 158.

There is one exception: in the Filter A and B **EG Select** parameters, you can select any of the MOD-7 envelopes: EG1...EG9, plus the Amp EG.

6-4: Filter LFO Mod.

The Filter LFO Mod page is identical to that of the AL-1. For detailed information, see "5-4: Filter LFO Mod." on page 161.

PROGRAM > MOD-7: Amp & Mixer

7-1: Mixers 1-3

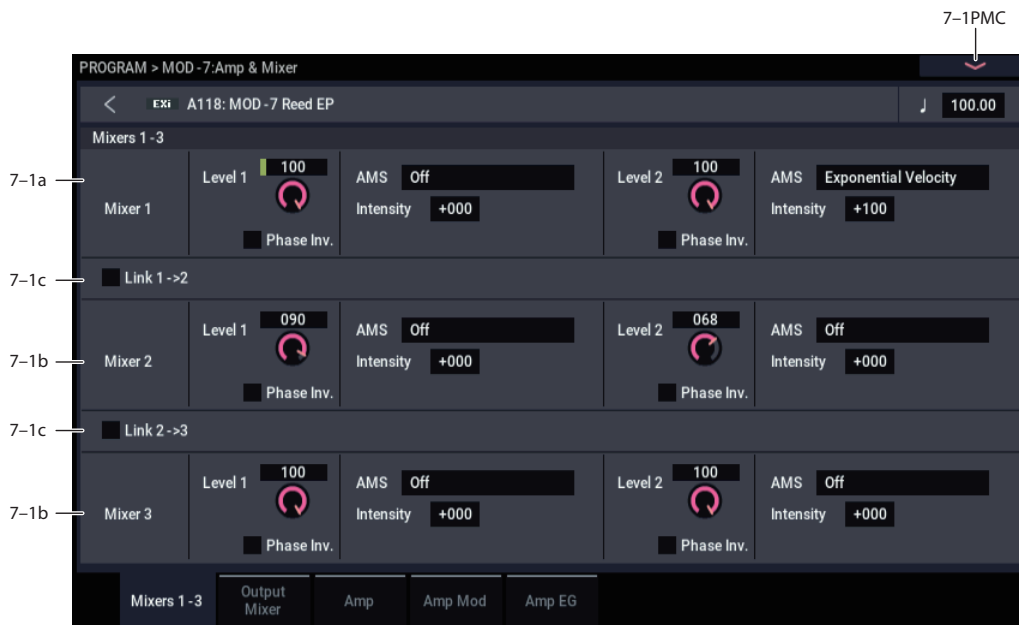

Overview

These are the three 2-in, 1-out mixers on the Patch Panel. They can be used for mixing signals together, or for additional control of volume and phase. All input levels can be modulated via AMS.

Tip: using a VPM Oscillator as a mixer

The three mixers should be sufficient for almost all purposes. In a pinch, however, you can also create a mixer out of an unused VPM Oscillator. To do so, set the Mode to Waveshaper, and set the Table to Linear. Note that this has a much higher CPU cost than a normal mixer.

Tip: creating splits between elements

You can easily create a keyboard or velocity split between two different sounds within a single MOD-7 patch. To do so:

1. Create the two elements of the patch.

For instance, three VPM oscillators creating a bell timbre, and three others creating a pad.

2. Route the two elements to two inputs of any mixer.

You can use one of Mixers 1-3, or the Output Mixer.

3. On the mixer, set input 1's level to 100, and input 2's level to 0.

4. Set an AMS Mixer to Gate.

5. In the AMS Mixer, set the Source to Note Number to create a keyboard split, or to Velocity or Exp Velocity to create a velocity split.

6. Set both the Below and At & Above outputs to fixed values; 00 for below, 99 for above.

7. The Threshold controls the split point; set it as desired.

When the Source is set to Note Number, a Threshold of 00 is middle C.

8. Assign the output of the AMS Mixer to modulate the two mixer inputs from step (1).

9. Set the AMS Intensity to -100 for input 1, and +100 for input 2.

Now, if the input is below the Threshold, input 1 will be heard; if the input is above the Threshold, input 2 will be heard.

7-1a: Mixer 1

Input 1

Level [0...100]

This controls the volume level for input 1.

Phase Invert [Off, On]

This inverts the phase of input 1.

AMS [List of AMS Sources]

This selects the main modulation source for controlling the Level. For a list of AMS sources, see "Alternate Modulation Source (AMS) List" on page 903.

Intensity [-100...+100]

This controls the depth and direction of the Level modulation.

Input 2

The controls for Input 2 are the same as those for "Input 1," above.

7-1b: Mixers 2 and 3

The controls for Mixers 2 and 3 are the same as those for “7-1a: Mixer 1,” above.

7-1c: Link

The Link buttons let you combine two or three of the mixers together, cascading the output of one into the next.

To create a 4-in, 1-out mixer, use either of the Link buttons. To create a 6-in, 1-out mixer, use both of them.

Internally, Mixers 2 and 3 have a third input dedicated to the Link function. This input is unity gain only, without a volume control.

Link 1->2 [Off, On]

This merges the output of Mixer 1 into the output of Mixer 2.

Link 2->3 [Off, On]

This merges the output of Mixer 2 into the output of Mixer 3.

7-1: Page Menu Commands

- Compare →p.112
- Write Program →p.112
- Exclusive Solo →p.113
- PAGE →p.126
- MODE →p.126

7-2: Output Mixer



The Output Mixer is a 6-in, stereo-out mixer, which takes signals from the Patch Panel and routes them to the Amp section.

Important: In order to hear the output of any block on the Patch Panel, including the VPM Oscillators, the PCM Oscillator, the Noise Generator, the Audio Input, and the Filters, the signal must eventually be patched into the Output Mixer.

In the Output Mixer, you can:

- Control the volume level, pan, and phase for each of the six inputs
- Modulate volume levels and pan via AMS.

7-2a: Input 1

Level [0...100]

This controls the volume level for Input 1.

AMS [List of AMS Sources]

This selects an AMS source to control the Level. For a list of AMS sources, see “Alternate Modulation Source (AMS) List” on page 903.

Intensity [-100...+100]

This controls the depth and direction of the Level AMS modulation.

Pan [L000...C064...R127]

This controls the input’s stereo pan. A setting of L000 places the sound at the far left, C064 in the center, and R127 to the far right.

AMS**[List of AMS Sources]**

This selects an AMS source to modulate **Pan**. For a list of AMS sources, see “Alternate Modulation Source (AMS) List” on page 903.

Intensity**[-127...+127]**

This controls the depth and direction of the AMS modulation for **Pan**.

For example, if **Pan** is set to C064 and **AMS** is set to Note Number, **positive (+)** intensities will cause the sound to move toward the right as you play higher than C4, and toward the left as you play lower than C4.

Negative (-) intensities will have the opposite effect.

Phase Invert**[Off, On]**

This inverts the phase of Input 1.

Tip: Creating random panning

Mixer inputs have no random pan setting per se. However, you can create this effect easily using AMS. To do so:

1. **Set the input’s Pan to C064.**
2. **Set the Pan AMS Intensity to +64.**
3. **Assign an unused LFO to Pan AMS.**

Next, make the following settings in the LFO:

4. **Enable the Key Sync check-box.**
5. **Set the Waveform to Random 1.**
6. **Enable the Stop check-box.**

Stop makes the LFO generate a single value at note-on, and then hold that value. Now, the input will have a different random pan position each time you play a note.

7-2b: Inputs 2...6

The controls for Inputs 2 through 6 are the same as those for Input 1, above.

✓ 7-2: Page Menu Commands

- Compare →p.112
- Write Program →p.112
- Exclusive Solo →p.113
- PAGE →p.126
- MODE →p.126

7-3: Amp

The Amp page is identical to that of the STR-1. For detailed information, see “6-1: Amp” on page 242.

7-4: Amp Modulation

The Amp Modulation page is identical to that of the STR-1. For detailed information, see “6-2: Amp Mod.” on page 243.

7-5: Amp EG 

The Amp EG interacts with the Amp and Amp Modulation settings to control the overall volume of the MOD-7. This EG always affects that overall volume, but it can also be used as an EG and AMS source elsewhere in the MOD-7.

The Amp EG is almost identical to EGs 1-9, with the following exceptions:

- Levels can only be positive.
- The Amp EG cannot be reset after it has entered its release phase.

For more information, please see “8-1: EG 1” on page 340.

PROGRAM > MOD-7: EG

The MOD-7 has nine assignable EGs, in addition to the Amp EG. Each of these can be used as an AMS modulation source to control a wide variety of parameters.

By default, EGs 1–6 are assigned to Output Level on VPM Oscillator 1–6, EG 7 is assigned to Output Level on the PCM Oscillator, and EG 8 is assigned to Filter A Cutoff.

These EGs are similar to those of the AL-1, but with slightly simplified AMS modulation, **Sustain Level** modulation, and a new parameter: **Trigger at Note-On**.

8-1: EG 1 AMSource



The EGs, or Envelope Generators, let you create complex, time-varying changes to AMS-modulatable parameters. The controls on this page specify the shape of the EG. Among other things, you can:

- Create the basic EG shape by setting the levels and times of each segment.
- Control the curvature of each EG segment, for subtle control over the sound of the EG.
- Set up complex modulation of EG levels and times.
- Set up an AMS source, such as an LFO, to restart the EG.

One thing that you can't do on this page is to control how much effect the EG has on the parameters it modulates. To do that, you'll need to adjust the AMS intensities on the pages for the individual parameters.

8-1a: EG Reset

AMS [List of AMS Sources]

This selects an AMS source to reset the EG to the start point. For instance, you can use a tempo-synced LFO to trigger the EG in a repeating rhythm.

For a list of AMS sources, see “Alternate Modulation Source (AMS) List” on page 903.

Threshold [–99...+99]

This sets the AMS level which will trigger the EG reset. Among other things, you can use this to adjust the exact point in an LFO's phase at which the EG will be reset, effectively controlling its “groove” against other rhythmic effects.

When the threshold is **positive**, the EG triggers when passing through the threshold moving upwards. When the threshold is **negative**, the EG triggers when passing through the threshold moving downwards.

Note: With some LFO shapes, and with faster LFO speeds, the LFO may not always reach the extreme values of +99 or -99. In this case, setting the **Threshold** to these values may cause inconsistent behavior, or may mean that the EG doesn't reset at all. If this happens, reduce the **Threshold** until the EG triggers consistently.

Trigger at Note-On [Check-box]

On means that the EG will start automatically at note-on. This is the default.

Off means that the EG will only start when triggered via the selected AMS source. This is useful for delayed EGs, or triggered effects such as those described below.

Note: Even when this is set to **Off**, if the selected AMS trigger source is above the threshold at note-on, then the EG will trigger instantly.

Tip: Multiple Rhythmic Envelopes via the Step Sequencer

1. Set up several EGs with Trigger at Note-On set to Off, and the trigger AMS source set to the per-voice Step Sequencer.
2. Set each EG to use a different threshold value, so that the first to trigger has a low threshold, the next to trigger has a slightly higher threshold, and so on.

You can then use the Step Sequencer to trigger each EG at a specified time, synced to tempo. For complex rhythmic variations, you can then loop the Step Sequencer, modulate its start point, and reset the Step Sequencer from another AMS source.

Tip: Multiple Rhythmic Envelopes via LFOs

1. Set up several EGs with Trigger at Note-On set to Off, and the trigger AMS source set to one or more LFOs.
2. Set the LFO(s) to sync to tempo, with a large note value (such as a whole note).

By using a couple of LFOs at different frequencies, you can set up complex, essentially non-repeating patterns.

3. Set the LFO waveform(s) to Triangle.
4. Using the same trick as above, set the EG's thresholds to different levels.

You could also use this method with non-tempo-synced LFOs and slow EGs, to create gentle, evolving sounds.

8-1b: Envelope

EG

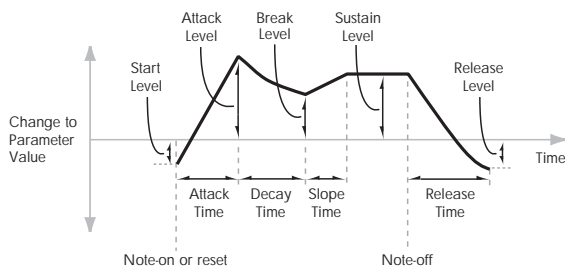

Envelopes create a modulation signal by moving from one level to another over a specified time, and then moving to another level over another period of time, and so on.

The parameters below let you set five levels, the amount of time it takes to go from each of the levels to the next, and the shape (from linear to curved) of each transition.

Level

Each of the five levels can be either positive or negative.

Positive levels will make the cutoff frequency (or other AMS destination) go up from its programmed value; **negative** levels will make it go down.

Start [-99...+99]

This sets the initial EG level, at note-on.

Attack [-99...+99]

This sets the level at the end of the Attack time.

Break [-99...+99]

Break, short for Break Point, sets the level at the end of the Decay time.

Sustain [-99...+99]

This sets the level at the end of the Slope time. Once it reaches the Sustain level, the EG will stay there until note-off, unless it is reset via AMS.

Release [-99...+99]

This sets the level at the end of the Release time.

Time

Higher values mean longer times, as shown below:

| EG Value | Actual Time |
|----------|--------------|
| 00 | 0.667 ms |
| 10 | 10 ms |
| 20 | 44 ms |
| 30 | 104 ms |
| 40 | 224 ms |
| 50 | 464 ms |
| 60 | 944 ms |
| 70 | 1.8 seconds |
| 80 | 3.8 seconds |
| 90 | 10.9 seconds |
| 99 | 87.3 seconds |

Attack [00...99]

This sets how long the EG takes to move from the Start level to the Attack level.

The minimum attack time is 2/3 of a millisecond—as fast as the most punchy of classic analog synths.

For the fastest possible attack time, you can set the Start level to +99; in this case, the EG will start instantaneously at its maximum value.

Decay [00...99]

This sets the time it takes to move from the Attack level to the Break level.

Slope [00...99]

This sets how long the EG takes to move from the Break level to the Sustain level. Once it reaches the Sustain level, the EG will stay there until note-off (unless it is reset via AMS).

Release [00...99]

This sets how long it takes the EG to move from the Sustain level to the Release level.

Curve

For the sake of simplicity, most of the diagrams in this manual show envelopes as being made out of straight lines. In actuality, though, envelopes are more likely to be made out of curves.

In other words, each segment's level will change quickly at first, and then slow down as it approaches the next point. This tends to sound better than straight, linear segments.

Classic analog synth envelopes made these curved shapes naturally. The NAUTILUS goes a step further than vintage synths, however, and lets you control the amount of curvature separately for each of the four envelope segments.

When you change the curvature, the EG times remain the same. However, greater curvature will tend to *sound* faster, because the value changes more quickly at the beginning.

Different curve settings for up and down

You may find that different amounts of curvature are suitable for segments which go up and segments which go down.

For instance, a curve of 3 is a good default setting for upward segments, such as Attack. On the other hand, a curve of 6 or more is good for downward segments, such as Decay and Release.

EG Curve

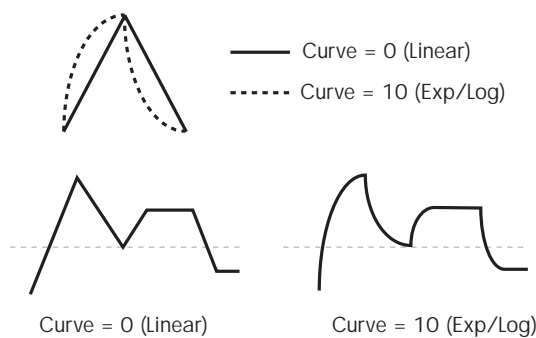

Attack [0 (Linear), 1...9, 10 (Exp/Log)]

This sets the curvature of the Attack segment - the transition from the Start level to the Attack level.

Decay [0 (Linear), 1...9, 10 (Exp/Log)]

This sets the curvature of the Decay segment - the transition from the Attack level to the Break level.

Slope [0 (Linear), 1...9, 10 (Exp/Log)]

This sets the curvature of the Slope segment - the transition from the Break level to the Sustain level.

Release [0 (Linear), 1...9, 10 (Exp/Log)]

This sets the curvature of the Release segment - the transition from the Sustain level to the Release level.

8-1c: Level Modulation

These settings let you use an AMS source to control the Level parameters of the EG. The Start, Attack, Break, and Sustain levels share a single AMS source, but each has its own modulation intensity.

By using different settings for each of the four levels, you can cause both subtle and dramatic changes to the EG shape, as shown below.

EG Level Modulation

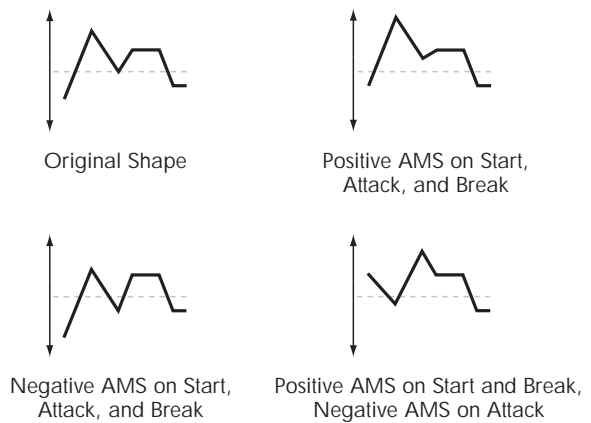

Once an EG segment begins, it can't be modulated

Once the EG has started a segment between two points, that segment can no longer be modulated. This includes both the time of the segment, and the level reached at the end of the segment.

For instance, if the EG is in the middle of the Decay time, you can no longer modulate either the Decay time or the Break level.

As another example, let's say that you've assigned the Common LFO to modulate Break Level. The LFO may be moving all the time, but the Break Level is only affected by the LFO's value at the instant that the Decay segment starts. After that, the level is fixed.

Finally, this also means that modulating the Start level, Attack level, or Attack time will not affect notes that are already sounding, unless the EG is then reset via AMS.

AMS [List of AMS Sources]

This selects an AMS source to control the EG's Level parameters.

For a list of AMS sources, see "Alternate Modulation Source (AMS) List" on page 903.

Start [-99...+99]

This controls the depth and direction of the AMS modulation for the Start level.

For example, if you set the AMS source to Velocity and set Start to +99, the Start level will increase as you play harder. If you instead set Start to -99, the Start level will decrease as you play harder.

Attack [-99...+99]

This controls the depth and direction of the AMS modulation for the Attack level.

Break [-99...+99]

This controls the depth and direction of the AMS modulation for the Break level.

Sustain [-99...+99]

This controls the depth and direction of the AMS modulation for the Sustain level.

8-1d: Time Modulation

These settings let you use an AMS source to control the Time parameters of the EG. The Attack, Decay, Slope, and Release times share a single AMS source, but each has its own modulation intensity.

EG Time Modulation

AMS=Velocity, Intensity = a positive (+) value

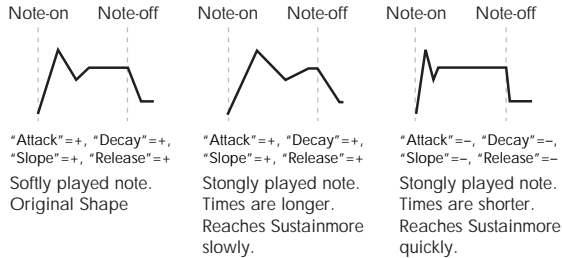

AMS [List of AMS Sources]

Selects the AMS source to control the EG's Time parameters. Velocity and Keyboard Track can both be useful here, for instance.

For a list of AMS sources, see "Alternate Modulation Source (AMS) List" on page 903.

Attack [-99...+99]

This controls the depth and direction of the AMS modulation for the Attack time.

When the AMS source is at its maximum value—for instance, when Velocity is at 128—a setting of +8 will make the segment time almost twice as long, and a setting of -8 will cut the segment time almost in half.

For example, if you set the AMS source to Velocity and set Attack to +99, the Attack time will get much longer at higher velocities. If you instead set Attack to -99, the Attack time will get much shorter at higher velocities.

Decay [-99...+99]

This controls the depth and direction of the AMS modulation for the Decay time.

Slope [-99...+99]

This controls the depth and direction of the AMS modulation for the Slope time.

Release [-99...+99]

This controls the depth and direction of the AMS modulation for the Release time.

✓ 8-1: Page Menu Commands

- Compare →p.112
- Write Program →p.112
- Exclusive Solo →p.113
- Copy Envelope →p.182
- Swap Envelope →p.182
- PAGE →p.126
- MODE →p.126

8-2: EG 2 AMSource

8-3: EG 3 AMSource

8-4: EG 4 AMSource

8-5: EG 5 AMSource

8-6: EG 6 AMSource

8-7: EG 7 AMSource

8-8: EG 8 AMSource

8-9: EG 9 AMSource

The MOD-7's EGs 2 through 9 are identical to EG1. For detailed explanations, please see "8-1: EG 1" on page 340.

PROGRAM > MOD-7: Seq, LFO, and AMS Mixers

The MOD-7 has one per-voice Step Sequencer and four assignable LFOs, in addition to the EXi Program's Common LFO and Common Step Sequencer. Each of these can be used as an AMS modulation source to control a wide variety of parameters.

There are also eight AMS Mixers: four full-functioned, and another four which support only the **A+B** and **Amt AxB Mixer Types**.

9-1: Step Sequencer AMSource

The MOD-7's Step Sequencer identical to that of the AL-1. For detailed explanations, please see "8-1: Step Sequencer," on page 173.

9-2: LFO 1 AMSource

9-3: LFO 2 AMSource

9-4: LFO 3 AMSource

9-5: LFO 4 AMSource

The MOD-7's LFOs 1, 2, 3, and 4 are identical to those of the AL-1. For detailed explanations, please see "8-2: LFO 1," on page 175.

9-6: AMS Mixers 1/2 AMSource

9-7: AMS Mixers 3/4 AMSource

The MOD-7's AMS Mixers 1 through 4 are identical to those of the AL-1. For detailed explanations, please see "9-1: AMS Mixer," on page 179.

9-8: AMS Mixers 5/6 AMSource

9-9: AMS Mixers 7/8 AMSource

The MOD-7's AMS Mixers five through 8 are similar to those of the AL-1, but support only the **A+B** and **Amt AxB Mixer Types**. For detailed explanations, please see "9-1: AMS Mixer," on page 179.

MOD-7: Tone Adjust

MOD-7 Tone Adjust Default Settings

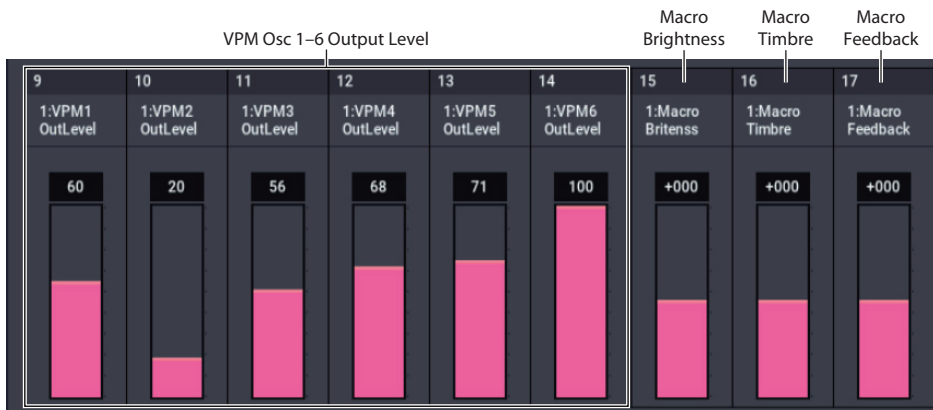
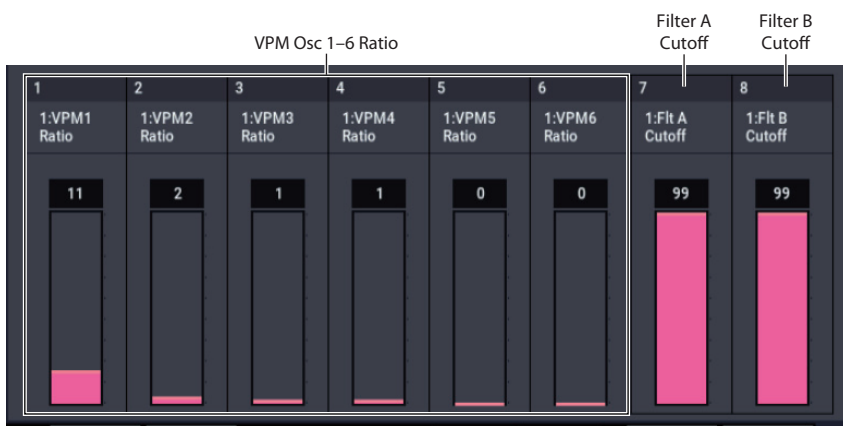
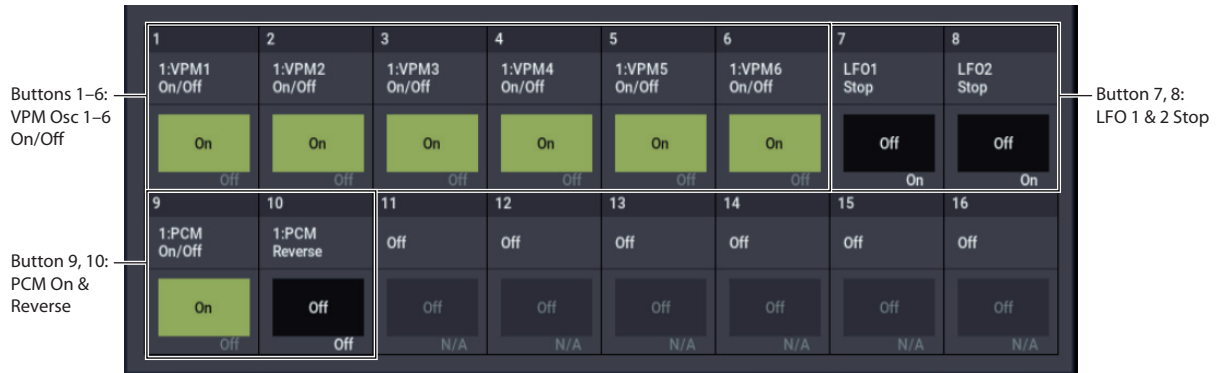

Tone Adjust provides an elegant physical interface to the MOD-7's parameters. Most of the factory sounds use the default layout, as shown above. You can also customize the layout for individual sounds, if desired.

For more information about Tone Adjust, please see "0-9a: Tone Adjust," on page 29.

Common Tone Adjust parameters

Except as noted below, the Common Tone Adjust parameters behave as described under "Common Tone Adjust Parameters," on page 31.

Filter/Amp EG Attack Time.
(-99...+99, CC#73)

This scales the attack time of EG8 and the Amp EG. It interacts with CC# 73.

Filter/Amp EG Decay Time.
(-99...+99, CC#75)

This scales the decay time of EG8 and the Amp EG. It interacts with CC# 75.

Filter/Amp EG Sustain Level.
(-99...+99, CC#70)

This scales the sustain levels of EG8 and the Amp EG. It interacts with CC# 70.

Filter/Amp EG Release Time.
(-99...+99, CC#72)

This scales the release time of EG8 and the Amp EG. It interacts with CC# 72.

Filter EG Attack Time, Decay Time, Sustain Level, and Release Time apply to EG8.

Pitch EG Attack Time, Decay Time, Sustain Level, and Release Time are not supported by the MOD-7.

MOD-7 Tone Adjust parameters

In addition to the Common Tone Adjust parameters listed above, the MOD-7 adds a number of its own parameters.

Note that these additional parameters are separate for each EXi, as opposed to being shared by both EXi in the Program.

All of the additional parameters are listed below. Tone Adjust parameters may affect the internal parameters in one of two ways: they may be **Relative**, in which case they scale the existing parameter value, or **Absolute**, in which case they over-write the existing value. Unless otherwise noted, all of the MOD-7 parameters are **Absolute**.

Macro Parameters

Brightness

Brightness Vel Sens

Timbre

Feedback

Detune

Noise

Saturation

Filter Freq

PCM Oscillator

On/off

MS Select

MS Bank

MS Min

MS Max

Start Offset

Reverse

Transpose

Tune

VPM Oscillators 1...6

On/off

Mode

Feedback

Ratio

Table

Drive

Output Level

Filters A and B

Type

Cutoff

Resonance

EG Int

LFO Int

LFOs

In addition to supporting the standard Tone Adjust LFO parameters, the MOD-7 adds the following separate controls:

- LFO 1 through 4 Waveform
- LFO 3 and 4 Speed

Step Sequencer

Attack Smoothing

Decay Smoothing

EXi MOD-7: Page Menu Commands

| | |
|------------------------|--------|
| Compare | →p.112 |
| Write Program | →p.112 |
| Exclusive Solo | →p.113 |
| Remap MS/Sample Banks | →p.121 |
| Copy Envelope | →p.182 |
| Swap Envelope | →p.182 |
| Copy Step Sequencer | →p.140 |
| Copy LFO | →p.182 |
| Swap LFO | →p.182 |
| Delete All Connections | →p.282 |
| Copy VPM Oscillator | →p.347 |
| Swap VPM Oscillators | →p.347 |
| PAGE | →p.126 |
| MODE | →p.126 |

Copy VPM Oscillator

This command copies all the parameters of one VPM Oscillator to another VPM Oscillator. A dialog box allows you to select the source and destination Oscillators, within the current Program.

Swap VPM Oscillators

This command swaps all of the parameters between two VPM Oscillators, like copying each to the other in a single step. Note that it does not automatically copy any Patch Panel connections; you'll need to do that manually, if necessary.

For instance, let's say that you've created a custom algorithm bit by bit, and you end up with two chains of Modulators and Carriers:

VPM Osc 1→VPM Osc 2→VPM Osc 6

VPM Osc 4→VPM Osc 5→VPM Osc 3

To make the algorithm easier to understand, you might want to do the following:

1. Use the **Swap VPM Oscillator** command to swap the parameters of VPM Osc 3 and VPM Osc 6.
2. Manually correct the Patch Panel connections to VPM Osc 3 and 6, as necessary.

EXi: SGX-2 Premium Piano

SGX-2 Overview

The SGX-2 Premium Piano EXi is designed to provide an optimal acoustic piano experience, combining world-class sounds, subtle performance nuances, and a dedicated, easy-to-use interface. Features include:

- Virtual Memory Technology (VMT), for access to gigabytes of sample data
- Full chromatic sampling, with every note sampled in stereo at up to 12 velocity levels, for natural and smooth response
- True damper resonance, also chromatically sampled, with multiple velocity layers
- Modeled string resonance
- Dedicated Una Corda samples (provided only with certain Piano Types)
- No loops: sounds decay naturally
- High polyphony—up to 100 dual-stereo voices, the equivalent of 400 mono voices
- Realistic performance nuances, including mechanical noise controlled by release velocity, damper pedal noise controlled by pedal velocity, and note release

Unsupported EXi Common parameters

The SGX-2 supports most of the EXi Common parameters, except for the voice allocation options detailed below:

- **Poly Legato**
- Mono **Mode** (**Normal** or **Use Legato Offset**)
- **Unison**, including **Number of Voices**, **Detune**, and **Thickness**

EXi PROGRAM > SGX-2: Home

0-1: Overview



This is the main page of PROGRAM mode. For a full description of this page and all of its functions, please see “EXi PROGRAM > Home” on page 127. This section describes only the overview display, which differs for each individual EXi.

0-1b: Overview and Page Jump

This PROGRAM > Home page shows an overview of the most important settings for the Program’s two EXi instruments. The specific parameters will vary, depending on which EXi are being used. The parameters for the SGX-2 are described below.

The graphics give you a quick way to check all of these settings at a glance. They also let you jump instantly to any of the displayed parameters. Just touch one of the graphics, and you’ll jump to the page containing its parameters.

Tip: Pressing EXIT several times will always bring you back to this page.

Piano Type

This shows the selected Piano Type, which controls the basic sound of the SGX-2. Touch this area to jump to the PROGRAM > SGX-2: Main page. For more information, see “PROGRAM > SGX-2: Main” on page 352.

Components and levels

This section shows the status and volume levels of the Damper Resonance, Damper Noise, Mechanical Noise, and Note Release components. If a component is turned off, it’s shown in gray. Touch this area to jump to the SGX-2’s Main page.

Piano graphic

This shows the lid position setting. Touch the graphic to jump to the SGX-2’s Main page.

String Resonance and Una Corda graphics

This shows the status of the String Resonance and Una Corda features. When the graphics are shown in color, they are enabled; when they are grayed out, they are disabled. Touch the graphic to jump to the String Resonance/Una Corda page.

Common Key Zone

This shows the key zones for EXi1 and EXi2, as set on the Common section’s Program Basic page, in relation to the entire MIDI note range. The range of the 61-, 73-, or 88-note keyboard is also shown, as appropriate.

Press this area to jump to the PROGRAM > Basic/X-Y/Controllers– Program Basic page.

0-1d: Common

3Band EQ Graphic

| | |
|-------------------------------|--------------------|
| Mute (1) | [On, Off] |
| Mute (2) | [On, Off] |
| Mute (DrumT) | [On, Off] |
| EXi1 Instrument Volume | [000...127] |
| EXi2 Instrument Volume | [000...127] |
| Drum Track Volume | [000...127] |

This is the same as with HD-1 programs. For more information, please see “0-1d: Common” on page 4.

✓ 0-1: Page Menu Commands

- Compare →p.112
- Write Program →p.112
- Exclusive Solo →p.113
- Show MS/WS/DKit Graphics →p.113
- Add To Set List →p.113
- Initialize Program →p.113

- PAGE →p.126
- MODE →p.126

PROGRAM > SGX-2: Main

4-1: Main

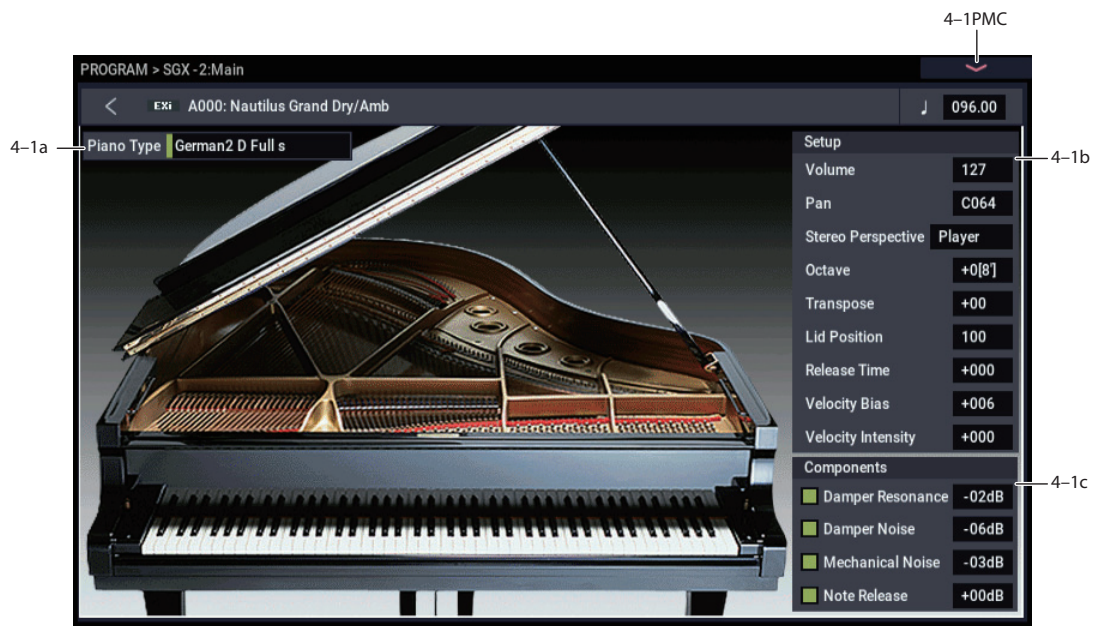

4-1a: Piano Type

Piano Type [List]

The **Piano Type** selects the basic sound character, like selecting which of several pianos to play. The other parameters, such as **Velocity Bias**, **Lid Position**, and so on, let you make fine adjustments to the sound to suit your taste and touch.

More technically, the **Piano Type** controls the sample selection, the way that the samples are laid out across the keyboard and velocity ranges, and the many internal parameters which control how the samples are played.

If the **Piano Type** uses Multisamples which are not loaded, the Samples Not Loaded message will appear at the top of the display. To fix this, use the **Load required samples** menu command (see “Load required samples” on page 114).

When the **Piano Type** is changed, other parameters on this page remain unaffected.

Generally, an “s” after the **Piano Type** name indicates that the original stretch tuning of the piano was used.

Note: Some Piano Types may not be preloaded by factory default. These types will eventually be offered as optional data. Also note that when you select Piano Types that are not included by factory default, no sound will be heard.

Piano graphic

This shows the lid position setting. Touch the graphic to jump to the SGX-2’s Main page.

4-1b: Setup

Volume [0...127]

This controls the overall volume of the piano. It’s the same as the standard EXi Volume; changes in one place are reflected in the other.

Pan [Random, L001...C064...R127]

This controls the stereo position of the piano, “leaning” the original stereo image to the left or right as desired. A setting of **C064** maintains the original stereo image; **L001** places the sound at the far left, and **R127** at the far right.

When this is set to **Random**, the pan position will change at each note-on. All notes will be change to the new position, so this is for special effects only.

MIDI You can also control pan via MIDI Pan (CC#10). A CC#10 value of 0 or 1 places the sound at the far left, 64 places the sound at the location specified by the **Pan** parameter, and 127 places the sound at the far right.

Note: You can select Random pan only from the on-screen UI, and not from MIDI.

Stereo Perspective [Player, Audience]

This controls the left/right perspective of the piano. You can choose to hear the sound either as you would in the playing position or as someone listening on the other side of the piano.

Player puts the bass notes on the left.

Audience puts the bass notes on the right.

Octave [-2...+0...+1]

This transposes the piano in octaves. The default is +0.

Transpose [-12...+12]

This adjusts the pitch in semitones, over a range of ± 1 octave.

Lid Position [0...+100]

Opening and closing the lid controls the overall brightness of the piano. **0** is fully closed, **50** is the normal position, and **100** is fully open. The on-screen graphic reflects this setting, with four different graphics from fully closed to fully open.

MIDI You can also scale the **Lid Position** via MIDI CC#74.

Release Time [-100...0...+100]

This scales the piano's release time—the time that it takes the note to ring out after you release the key (not including effects such as delay and reverberation).

0 is the default, and reflects the preset release time of the selected **Piano Type**.

-100 sets the release time to the minimum time, and **+100** sets it to the maximum time.

MIDI You can also scale the **Release Time** via MIDI CC#72.

Velocity Bias [-100...0...+100]

This alters the velocity response by compressing one part of the range while expanding the other, creating a “darker” or “brighter” overall effect while maintaining the full velocity range from ppp to fff. Note that this affects timbre only—not volume.

Velocity Bias

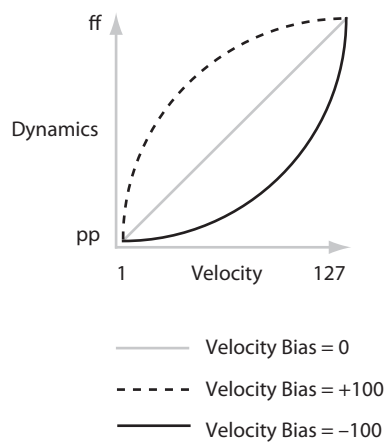
**Velocity Intensity** [-100...0...+100]

This scales velocity modulation of volume. Other effects of velocity, such as brightness, sample selection, and so on, are unaffected.

0 is the default, and reflects the preset velocity intensity of the selected **Piano Type**.

-100 removes the velocity modulation entirely. **+100** means maximum modulation in the same direction, positive or negative, as the original **Piano Type**.

4-1c: Components**Damper Resonance** [Off, On]

Pressing down the damper pedal lifts the felt dampers from all of the strings across the keyboard, allowing them to resonate freely. In this state, playing any note causes the rest of the strings to vibrate slightly, creating a rich, complex

resonance. A similar but softer effect is produced by first playing and holding a note, and then pressing down the damper pedal. The SGX-2 models these behaviors.

This parameter controls the triggering of new **Damper Resonance** samples. Editing the parameter does not affect currently sounding notes.

Level [-48 dB...+6 dB]

This sets the volume level for the **Damper Resonance** samples.

The level is adjusted in steps of 1dB. This also applies to the other Level parameters, below.

Damper Noise [Off, On]

When the damper pedal is pressed down, the noise of the impact causes all of the strings to resonate slightly. If you press down the damper quickly, the noise will be more prominent; if you press down slowly, it will be softer.

This parameter controls the triggering of new **Damper Noise** samples. Changes take effect the next time that you press down the damper pedal.

Level [-48 dB...+6 dB]

This controls the volume level of the **Damper Noise**.

As with the On/Off parameter above, changes to Level do not affect currently sounding **Damper Noise** samples.

Mechanical Noise [Off, On]

This is the mechanical sound of the key being released.

This parameter controls the triggering of new **Mechanical Noise** samples. Changing it does not affect keys which have already been released.

Level [-48 dB...+6 dB]

This controls the level of the **Mechanical Noise**.

As with the On/Off parameter above, changes to Level do not affect currently sounding **Mechanical Noise** samples.

Note Release [Off, On]

This is the sound of the damper hitting the string. If the damper pedal is not used, this happens at the same time as the **Mechanical Noise**, above. If the damper pedal is being used, it happens when the damper pedal is released—which may be some time after the key is released.

This parameter controls the triggering of new **Note Release** samples. Changing it does not affect notes which have already been released.

Level [-48 dB...+6 dB]

This sets the volume level for **Note Release** samples.

As with the On/Off parameter above, changes to Level do not affect currently sounding **Note Release** samples.

✓ 4-1: Page Menu Commands

- Compare →p.112
- Write Program →p.112
- Exclusive Solo →p.113
- PAGE →p.126
- MODE →p.126

PROGRAM > SGX-2: String Resonance/Una Corda

5-1: String Resonance/Una Corda

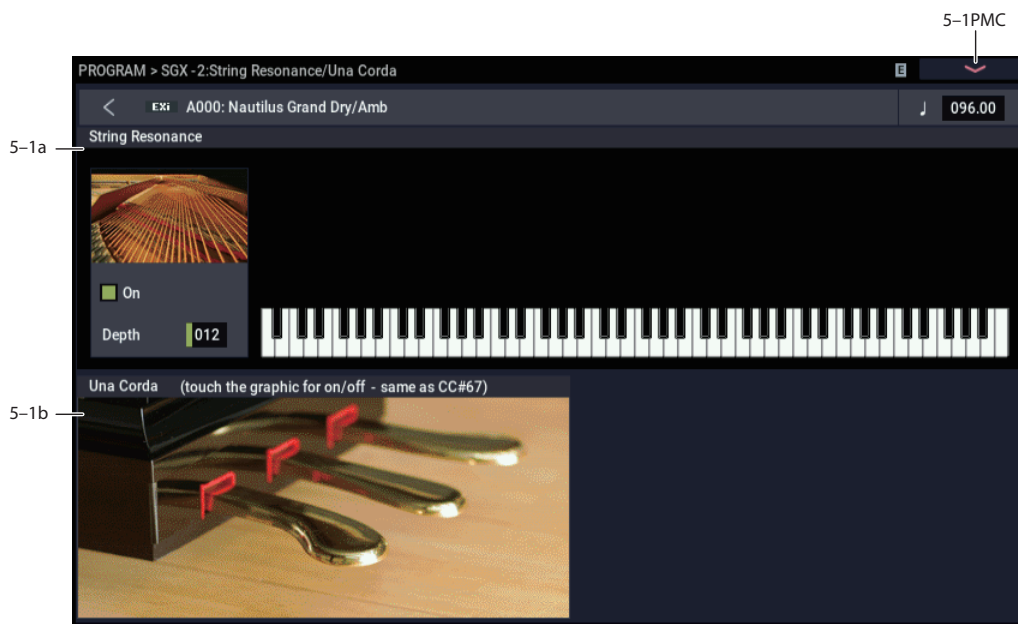

5-1a: String Resonance

String Resonance [Off, On]

When a note is played on an acoustic piano, any other un-damped strings will resonate slightly, with an intensity corresponding to their harmonic relationship to the played note. An extreme example of this is heard when the damper pedal is down, at which point all of the strings resonate together. However, it also happens whenever a note is played while one or more other harmonically related notes are held. For instance, if you hold C2 and then sharply play and release C3, you'll hear a faint echo of the C3 ringing from the C2 string.

On: The SGX-2 models the individual string resonances described above. (The sound when the damper pedal is down is handled separately, by the **Damper Resonance** parameter.) The **Depth** parameter, below, controls the intensity of the resonance. Polyphony may be slightly reduced.

Off: The string resonance modeling is disabled. This option may offer slightly greater polyphony.

Depth [000...127]

This controls the overall volume of the string resonance.

String Resonance Graphic

This graphic offers a visual overview of the sounding String Resonance tones.

5-1b: Una Corda

Grand pianos typically have three pedals. From left to right, these are the Una Corda pedal (also called the soft pedal), the sostenuto pedal, and the sustain or damper pedal. When the soft/Una Corda pedal is pressed, the piano action shifts slightly to the right. This changes the positions of the hammers relative to the strings, which alters the tone and generally makes the sound softer. The amount of shift can be adjusted by a piano technician to produce subtle or more pronounced variations in timbre.

MIDI includes a standard Soft Pedal controller, CC#67. You can assign this to the Foot Switch (see "Foot Switch Assign" on page 675) or to SW1 or SW2 (see "1-8b: Panel Switch Assign" on page 48).

Most NAUTILUS sounds, including some SGX-2 **Piano Types**, respond to CC#67 by scaling down note velocities—as if you were playing a little softer than you actually are.

As an alternative to this approach, some SGX-2 **Piano Types** include dedicated Una Corda samples. When CC#67 is on, these **Piano Types** switch to a different, dedicated set of samples instead of modifying velocity.

Una Corda [Graphic]

If the selected **Piano Type** includes Una Corda samples, the graphic in this section of the display will be displayed in color. If it does not include Una Corda samples, the graphic will be grayed out.

The graphic also shows whether the Una Corda pedal is currently off (CC#67=0) or on (CC#67=127)—notice that the left-most pedal moves up and down.

Finally, you can touch the graphic to toggle CC#67 on and off. If you have SW1 or SW2 assigned to Soft (CC#67), you'll notice that its LED turns on and off as well.

✓ **5-1: Page Menu Commands**

- Compare →p.112
- Write Program →p.112
- Exclusive Solo →p.113
- PAGE →p.126
- MODE →p.126

SGX-2: Tone adjust

SGX-2 Tone Adjust Default Settings

Buttons:
1: Stereo Perspective
2: Resonance Enable

Buttons:
5: Note Release Enable
6: Mechanical Noise Enable
7: Damper Noise Enable

| | | | | | | | |
|--|--------------------------------------|------------------|------------------|--------------------------------------|--|--------------------------------------|------------------|
| 1 1:Stereo Perspective Off Player | 2 1:Resonance Enable On Off | 3 Off N/A | 4 Off N/A | 5 1:Note Release Ena On Off | 6 1:Mechanic Noise Ena On Off | 7 1:Damper Noise Ena On Off | 8 Off N/A |
| 9 1:Str Reso. Enable Off Off | 10 Off N/A | 11 Off N/A | 12 Off N/A | 13 Off N/A | 14 Off N/A | 15 Off N/A | 16 Off N/A |

Lid Position Resonance Level Velocity Intensity Release Time Note Release Level Mechanical Noise Level Damper Noise Level Velocity Bias

| | | | | | | | |
|----------------------------|---------------------------------|-----------------------------------|-----------------------------|----------------------------------|--------------------------------------|------------------------------------|------------------------------|
| 1 1:Lid Position 100 | 2 1:Resonance Level +00dB | 3 1:Velocity Intensity +000 | 4 1:Release Time +000 | 5 1:Note Release Lvl +00dB | 6 1:Mechanic Noise Level +00dB | 7 1:Damper Noise Level +00dB | 8 1:Velocity Bias +000 |
|----------------------------|---------------------------------|-----------------------------------|-----------------------------|----------------------------------|--------------------------------------|------------------------------------|------------------------------|

Button:
9: String Resonance Enable
Slider:
1: String Resonance Depth

| | | | | | | | | |
|-------------------------------|------------------|------------------|------------------|------------------|------------------|------------------|------------------|------------------|
| 9 1:Str Reso. Depth 050 | 10 Off N/A | 11 Off N/A | 12 Off N/A | 13 Off N/A | 14 Off N/A | 15 Off N/A | 16 Off N/A | 17 Off N/A |
|-------------------------------|------------------|------------------|------------------|------------------|------------------|------------------|------------------|------------------|

Common Tone Adjust parameters

The SGX-2 supports the following Common Tone Adjust parameters:

Off. This means that the Tone Adjust control has no effect.

Filter Cutoff. (-99...+99, CC#74, Relative)

This scales the **Lid Position**.

Amp Velocity Intensity. (-99...+99, Relative)

This scales the effect of velocity on volume.

-99 removes the velocity modulation entirely. +99 means maximum modulation in the same direction, positive or negative, as the original Program.

Filter/Amp EG Release Time.

(-99...+99, CC#72, Relative)

This scales the **Release Time**.

Common LFO Speed. (-99...+99, Relative)

This scales the EXi Program's Common LFO **Frequency**. When the LFO is in MIDI/Tempo mode, this adjusts the **Base Note**.

Common Step Sequencer Attack Smoothing. (00...99, Absolute)

This **Absolute** parameter sets amount of attack smoothing for the Common Step Sequencer. For more information, please see "Smoothing" on page 137.

Common Step Sequencer Decay Smoothing. (00...99, Absolute)

This **Absolute** parameter sets amount of decay smoothing

for the Common Step Sequencer. For more information, please see “Smoothing” on page 137.

SGX-2 Tone Adjust parameters

In addition to the Common Tone Adjust parameters listed above, the SGX-2 adds a number of its own parameters.

Note that these additional parameters are separate for each EXi, as opposed to being shared by both EXi in the Program.

All of the SGX-2 Tone Adjust parameters are of the **Absolute** type, which directly correspond to the main parameter values.

Setup

Volume

Pan

Velocity Bias

Lid Position

Stereo Perspective

Transpose

Velocity Intensity

Release Time

Components

Damper Resonance Enable

Damper Resonance Level

Note Release Enable

Note Release Level

Mechanical Noise Enable

Mechanical Noise Level

Damper Noise Enable

Damper Noise Level

String Resonance

String Resonance Enable

String Resonance Depth

EXi SGX-2: Page Menu Commands

| | |
|----------------|--------|
| Compare | →p.112 |
| Write Program | →p.112 |
| Exclusive Solo | →p.113 |
| PAGE | →p.126 |
| MODE | →p.126 |

EXi: EP-1 MDS Electric Piano

EP-1 Overview

New technology, classic sounds

The EP-1 provides incredible recreations of six classic tine and reed electric pianos, along with modeled vintage effects. Based on Korg's Multi-Dimensional Synthesis (MDS), the EP-1 delivers natural real-time expression without the limitations of ordinary sample playback. For instance, you'll appreciate the astonishingly smooth gradation of dynamics from pp to ff, without tell-tale split points - just like the real instruments.

Real-time control over noise elements, including mechanical key-off noises controlled by release velocity, gives your performances even greater realism and detail.

The EP-1 offers a maximum of 104 voices of polyphony.

Multi-Dimensional Synthesis (MDS)

MDS is an original technology from Korg. To create the EP-1 models, we first sample the instrument at many different dynamic levels and pitches. Next, we separate the main pitched sound from the hammer and key release noises, so that you have separate control over each. Finally, we use proprietary techniques to transform all of these elements into an MDS sound.

The result delivers natural control over both the velocity and time "dimensions." Velocity becomes a continuous transition from soft to loud and sweet to strong, without the telltale velocity-switching of traditional sample playback. Time becomes flexible, so that you can control the decay and release in a natural way, without resorting to volume or filter envelopes.

Other notes

EP-1 uses EXi fixed resources

The EP-1's amp and effects take up a little processing power even if you're not playing any notes on the keyboard. This amount is slightly less than half that of the CX-3; in Combinations or Songs, you can use a maximum of 18 EP-1s at once. Each EXi in each Program counts towards the maximum; for instance, a Program with two EP-1's counts as two, not as one.

For more information, see "CX-3 & other EXi: Limitations on EXi fixed resources" on page 380.

Unsupported EXi Common parameters

The EP-1 supports most of the EXi Common parameters, except for the voice allocation options detailed below:

- **Poly Legato**
- **Mono Mode (Normal or Use Legato Offset)**
- **Unison**, including **Number of Voices**, **Detune**, and **Thickness**

Half-Damper and Hold

Half-Damper is always active with the EP-1, regardless of the **Enable Half-Damper** setting (see "Enable Half-Damper" on page 133).

For Reed EPs, **Hold** is always on at G#6 and higher.

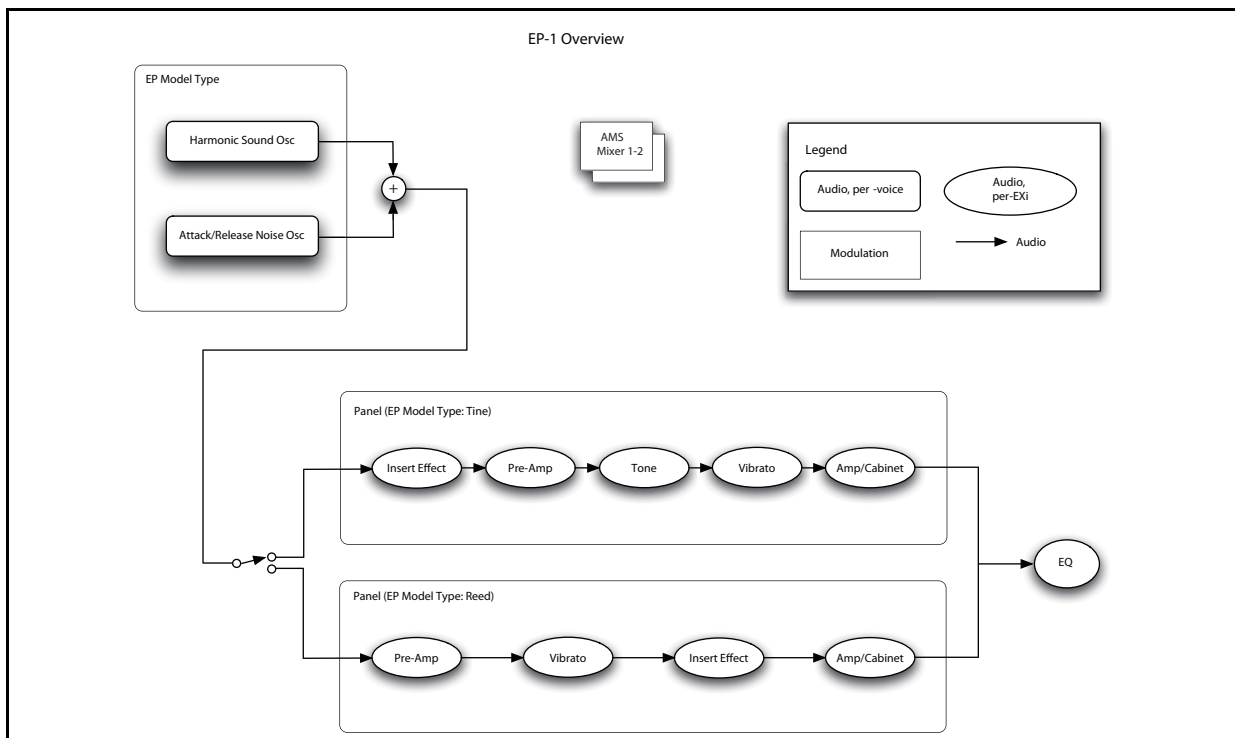

On-screen knobs, sliders & switches and the Parameter Details area

Parameter Details

The LCD displays include graphic knobs for all of the main EP-1 parameters. These let you view and edit parameters quickly and easily.

You can program any sound from the original electric pianos using only these knobs. If you want more flexibility and control, however, the EP-1 two AMS mixers, access to the EXi Program's Common LFO, Common Step Sequencer, and AMS modulation for almost every original knob, slider, and switch.

The entryway to these advanced features is the Parameter Details area, located in the lower right-hand part of the screen. This shows information for the selected knob or switch, including its parameter group and parameter name, its exact value, and its AMS assignments:

Using the graphic parameters

Editing knobs and sliders

To edit knobs and sliders:

1. Touch the knob or slider.

A yellow square will appear around the control, showing that it has been selected. The Parameter Details area will change to show the name and value of the current parameter, along with other related information.

2. Touch and then drag the knob to change its value. You can use either up-down or right-left gestures.

or:

Use any of the VALUE controllers to edit the value.

You can use the +/- buttons, or the VALUE dial.

As you edit the value, notice that the graphic knob or slider moves, and that the value in the Parameter Details area changes as well.

Editing on/off switches

To edit an on/off switch, such as the **VIBRATO ON/OFF** switch, simply:

1. Touch the switch to toggle the value.

Assigning AMS modulation

Most parameters support modulation via AMS. Sources and intensities can be edited in the Parameter Details area:

1. Touch the knob.

If the parameter supports AMS modulation, the Parameter Details area will show the AMS source and intensity settings.

2. Edit the AMS settings in the Parameter Details area.

Note: The graphic knobs always show their stored value. Absolute Tone Adjust settings edit these values, just as if you were editing the parameters themselves, and so the graphics will show the results. However, AMS modulation does not edit the stored value, and so the graphics do not include the results of AMS.

EXi PROGRAM > EP-1: Home

0-1: Overview



This is the main page of PROGRAM mode. For a full description of this page and all of its functions, please see “EXi PROGRAM > Home” on page 127. This section describes only the overview display, which differs for each individual EXi.

0-1b: Overview and Page Jump

This PROGRAM > Home page shows an overview of the most important settings for the Program’s two EXi instruments. The specific parameters will vary, depending on which EXi are being used.

The graphics give you a quick way to check all of these settings at a glance. They also let you jump instantly to any of the displayed parameters. Just touch one of the graphics, and you’ll jump to the page containing its parameters.

Tip: Pressing EXIT several times will always bring you back to this page.

Model Type

This shows the selected Model Type—Tine EP1, Reed EP 200A, etc.—which controls the basic sound of the EP-1. Touch this area to jump to the EP-1’s Basic/Oscillator page. For more information, see “EXi PROGRAM > EP-1: Basic/Oscillator” on page 362.

Panel/IFX

This section shows the EP’s front panel settings, the selected effect, and the cabinet (if enabled). Touch this area to jump to the EP-1’s Panel/IFX/Amp & Cabinet page. For more information, see “EXi PROGRAM > EP-1: Panel/IFX/Amp” on page 366.

Common Key Zone

This shows the key zones for EXi1 and EXi2, as set on the Common section’s Program Basic page, in relation to the entire MIDI note range. The range of the 61-, 73-, or 88-note keyboard is also shown, as appropriate.

Press this area to jump to the PROGRAM (Common) > Basic/X-Y– Program Basic page.

0-1d: Common

3Band EQ Graphic

| | |
|-------------------------------|-------------|
| Mute (1) | [On, Off] |
| Mute (2) | [On, Off] |
| Mute (DrumT) | [On, Off] |
| EXi1 Instrument Volume | [000...127] |
| EXi2 Instrument Volume | [000...127] |
| Drum Track Volume | [000...127] |

This is the same as with HD-1 programs. For more information, please see “0-1d: Common” on page 4.

✓ 0-1: Page Menu Commands

- Compare →p.112
- Write Program →p.112
- Exclusive Solo →p.113
- Show MS/WS/DKit Graphics →p.113
- Add To Set List →p.113
- Initialize Program →p.113
- PAGE →p.126
- MODE →p.126

EXi PROGRAM > EP-1: Basic/Oscillator

4-1: Basic

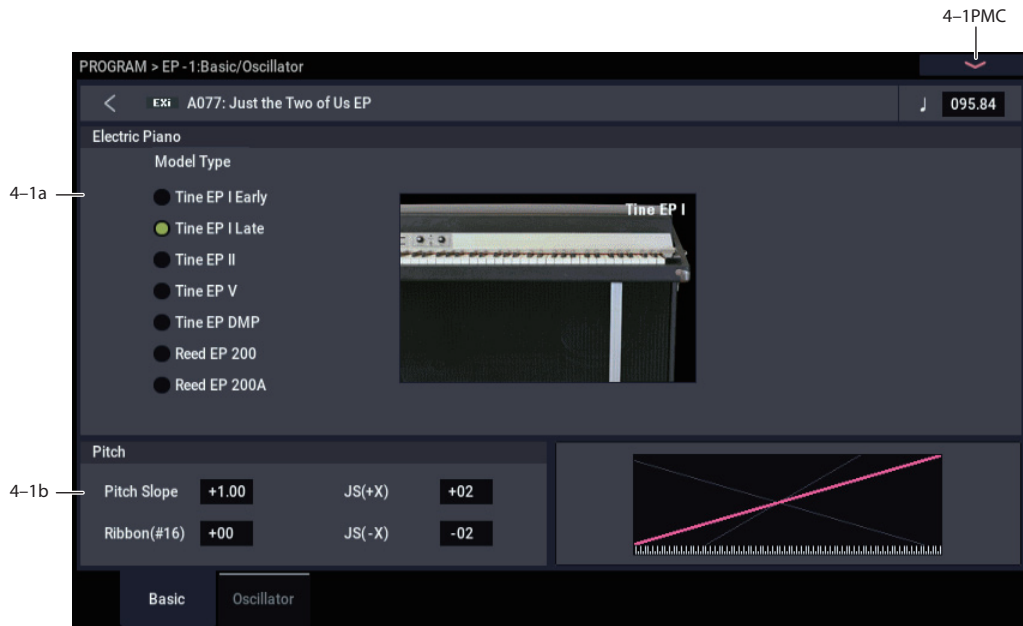

4-1a: Electric Piano

Model Type [Tine EP I Early, Tine EP I Late, Tine EP II, Tine EP V, Tine EP DMP, Reed EP 200, Reed EP 200A]

This selects the electric piano model. It mirrors the similar control on Panel/IFX/Amp page; changes in one place are reflected in the other. There are two basic types, Tine and Reed, reflecting the two standard electric piano technologies. Without getting too specific, Reed pianos are “whirly” and Tine pianos may take you down familiar “roads.”

For more information, see “Tine EP,” beginning on page 367 and “Reed EP,” beginning on page 369.

4-1b: Pitch

Pitch Slope [-1.0...+2.0]

Positive (+) values cause the pitch to rise as you play higher on the keyboard, and **negative (-)** values cause the pitch to *fall* as you play higher on the keyboard.

Normally, this should be set to the default of +1.0.

When **Pitch Slope** is set to 0, playing different notes on the keyboard won’t change the pitch at all; it will be as if you’re always playing C4. This can be useful for special effects sounds, for instance.

Pitch Slope, pitch, and note

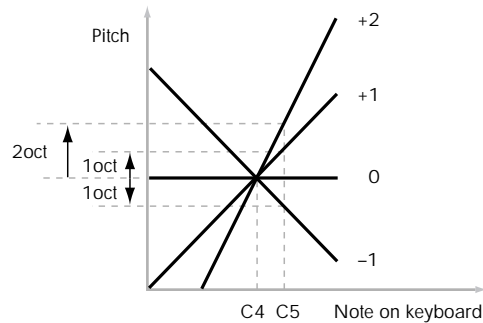

JS (+X) [-60...+12]

This sets the maximum amount of pitch bend, in semitones, when you move the joystick to the right. For normal pitch bend, set this to a positive value.

For example, if you set this to +12 and move the joystick all the way to the right, the pitch will rise one octave above the original pitch.

JS (-X) [-60...+12]

This sets the maximum amount of pitch bend, in semitones, when you move the joystick to the left. For normal pitch bend, set this to a negative value.

For example, if you set this to -60 and move the joystick all the way to the left, the pitch will fall five octaves below the original pitch. You can use this to create guitar-style downward swoops.

✓ 4-1: Page Menu Commands

- Compare →p.112
- Write Program →p.112
- Exclusive Solo →p.113
- PAGE →p.126
- MODE →p.126

4-2: Oscillator

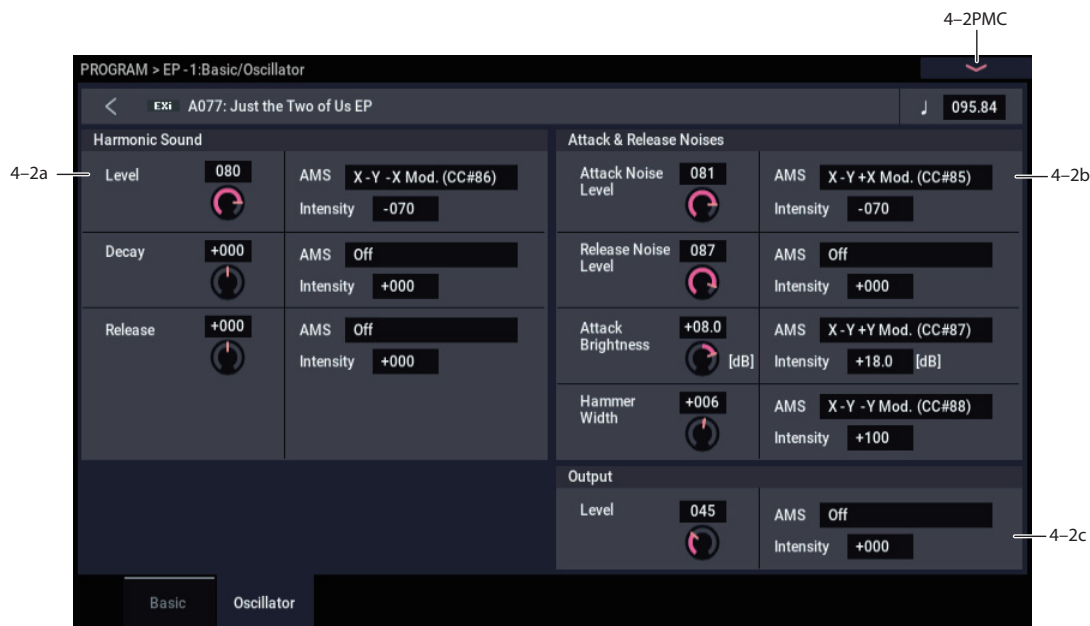

4-2a: Harmonic Sound

Level [000...100]

This controls the volume level of the main pitched part of the sound.

AMS [List of AMS Sources]

This selects an AMS source to control the **Harmonic Sound Level**. For a list of AMS sources, see “Alternate Modulation Source (AMS) List” on page 903.

Intensity [-100...+100]

This controls the depth and direction of the **Harmonic Sound Level** AMS modulation.

Decay [-100...+100]

This controls the decay time, including both the timbre and the level.

AMS [List of AMS Sources]

This selects an AMS source to control the **Decay**. For a list of AMS sources, see “Alternate Modulation Source (AMS) List” on page 903.

Intensity [-100...+100]

This controls the depth and direction of the **Decay** AMS modulation.

Release [-100...+100]

This controls the release time, including both the timbre and the level.

AMS [List of AMS Sources]

This selects an AMS source to control the **Release**. For a list of AMS sources, see “Alternate Modulation Source (AMS) List” on page 903.

Intensity [-100...+100]

This controls the depth and direction of the **Release** AMS modulation.

4-2b: Attack & Release Noises

Attack Noise Level [0...100]

This controls the volume level of the attack noise.

AMS [List of AMS Sources]

This selects an AMS source to control the **Attack Noise Level**. For a list of AMS sources, see “Alternate Modulation Source (AMS) List” on page 903.

Intensity [-100...+100]

This controls the depth and direction of the **Attack Noise Level** AMS modulation.

Release Noise Level [0...100]

This controls the volume level of the release noise. This level is also scaled by the volume of the harmonic sound at the time of release.

AMS [List of AMS Sources]

This selects an AMS source to control the **Release Noise Level**. For a list of AMS sources, see “Alternate Modulation Source (AMS) List” on page 903.

Intensity [-100...+100]

This controls the depth and direction of the **Release Noise Level** AMS modulation.

Attack Brightness [-18.0...+00.0...+18.0]

This controls the brightness of the attack noise.

AMS [List of AMS Sources]

This selects an AMS source to control the **Attack Brightness**. For a list of AMS sources, see “Alternate Modulation Source (AMS) List” on page 903.

Intensity [-18.0...+00.0...+18.0]

This controls the depth and direction of the **Attack Brightness** AMS modulation.

Hammer Width [-100...+100]

This controls the width of the hammer.

AMS [List of AMS Sources]

This selects an AMS source to control the **Hammer Width**. For a list of AMS sources, see “Alternate Modulation Source (AMS) List” on page 903.

Intensity [-100...+100]

This controls the depth and direction of the **Hammer Width** AMS modulation.

4-2c: Output**Level** [0...127]

This controls the overall output level.

AMS [List of AMS Sources]

This selects an AMS source to control the **Level**. For a list of AMS sources, see “Alternate Modulation Source (AMS) List” on page 903.

Intensity [-99...+99]

This controls the depth and direction of the **Level** AMS modulation.

✓ 4-2: Page Menu Commands

- Compare →p.112
- Write Program →p.112
- Exclusive Solo →p.113
- PAGE →p.126
- MODE →p.126

EXi PROGRAM > EP-1: Panel/IFX/Amp

5-1: Common



5-1a: Model Type

EP Model Type [Tine EP I, Tine EP II, Tine EP V, Tine EP DMP, Reed EP 200, Reed EP 200A]

This selects the electric piano model. It mirrors the similar control on P4; changes in one place are reflected in the other. There are two basic types, Tine and Reed, reflecting the two standard electric piano technologies. Without getting too specific, Reed pianos are “whirly” and Tine pianos may take you down familiar “roads.”

When you change between Tine and Reed types, the control panel will change as well; the two types have slightly different features. For detailed information on the panel parameters, see “Tine EP,” below, and “Reed EP,” beginning on page 369.

5-1b: Main Output

Note that volume is controlled on the panel, below.

Pan [Random, L001...C064...R127]

This controls the stereo position of the piano, “leaning” the stereo image to the left or right as desired. A setting of **C064** maintains the original stereo image; **L001** places the sound at the far left, and **R127** at the far right.

When this is set to **Random**, the pan position will change at each note-on. All notes will be change to the new position, so this is for special effects only.

MIDI You can also control pan via MIDI Pan (CC#10). A CC#10 value of 0 or 1 places the sound at the far left, 64 places the sound at the location specified by the **Pan** parameter, and 127 places the sound at the far right.

Note: You can select Random pan only from the on-screen UI, and not from MIDI.

5-1c: Insert Effect

Type [Off, Small Phase, Orange Phase, Black Phase, Vintage Chorus, Black Chorus, EP Chorus, Vintage Flanger, Red Comp, VOX Wah]

This selects the pedal to use for the insert effect. Touch either the text or the effect graphic to call up a graphical list of the effects.

The selected effect’s parameters appear in the panel below. For information on the individual effects, see “Insert Effects,” beginning on page 370.

(Insert Effect Enable) [On, Off]

This button turns the insert effect on and off. You can use this to temporarily bypass the effect, for instance.

5-1d: Parameter Details

When you touch a knob, slider, or switch on the panel graphic, a yellow square appears around it to show that it has been selected.

This area shows details for the selected control, including its name, value, and AMS assignments.

(Parameter name) [range depends on parameter]

This shows the name and exact value of the parameter. You can edit the parameter value with any of the standard data-entry controls.

AMS [List of AMS Sources]

This selects a modulation source to control the selected parameter. For a list of AMS sources, see “Alternate Modulation Source (AMS) List” on page 903.

Intensity [range depends on parameter]

This controls the depth and direction of the AMS modulation. For unipolar parameters, the range is usually the same as that of the selected parameter, in both positive and negative directions. For instance, if the parameter range is 0.0...10.0, the Intensity range will generally be -10.0...+10.0.

Tine EP

These parameters apply when one of the Tine pianos is selected as the **EP Model Type**.

5-1e: Pre-amp**VOLUME** [0...10.0]

This controls the volume level of the preamp. The default is 8.0.

AMS [List of AMS Sources]

This selects an AMS source to control the **VOLUME**. For a list of AMS sources, see “Alternate Modulation Source (AMS) List” on page 903.

Intensity [-10.0...+10.0]

This controls the depth and direction of the **VOLUME** AMS modulation.

5-1f: Tone**TREBLE** [-10.0...+10.0]

This controls the high-frequency boost or cut.

AMS [List of AMS Sources]

This selects an AMS source to control the **TREBLE** setting. For a list of AMS sources, see “Alternate Modulation Source (AMS) List” on page 903.

Intensity [-10.0...+10.0]

This controls the depth and direction of the **TREBLE** AMS modulation.

BASS [-10.0...+10.0]

This controls the low-frequency boost or cut.

AMS [List of AMS Sources]

This selects an AMS source to control the **BASS** setting. For a list of AMS sources, see “Alternate Modulation Source (AMS) List” on page 903.

Intensity [-10.0...+10.0]

This controls the depth and direction of the **BASS** AMS modulation.

5-1g: Vibrato**ON/OFF** [On, Off]

This enables the Vibrato effect.

AMS [List of AMS Sources]

This selects an AMS source to turn the vibrato on or off. For a list of AMS sources, see “Alternate Modulation Source (AMS) List” on page 903.

AMS Mode [Toggle, Momentary]

This controls the way in which the vibrato **ON/OFF** AMS works.

When this is set to **Toggle**, the vibrato **ON/OFF** AMS will alternate between on and off. For instance, if vibrato is **OFF**, and **AMS** is assigned to a footswitch, the first press will turn on the Vibrato, and the next press will turn it off again.

Momentary means that the change happens only while the controller is enabled. Continuing the example from above, when the footswitch is pressed down, the Vibrato will turn on; when the footswitch is released, the Vibrato will turn off again.

AMS lets you switch to the opposite of the programmed setting. For instance, if vibrato is **ON**, and the **AMS Mode** is set to **Momentary**, then pressing down on the footswitch would turn off the Vibrato.

If you set AMS to use a continuous controller, such as the Joystick, values of 0–63 are as if the switch was off, and values of 64–127 are as if the switch was on.

Finally - note that the assignable switches, **SW1** and **SW2**, can themselves be set to either momentary or toggle modes, and these settings are reflected by the switch LEDs. Individual parameter mode settings, such as the vibrato **ON/OFF** AMS Mode, do *not* affect the LEDs.

So, if you're using **SW1** or **SW2** as the AMS source, it's best to set the AMS Mode to Momentary, and then just let the switch itself determine the momentary/toggle behavior.

SPEED [00.0...10.0]

This controls the rate of the Vibrato effect. The default is 5.0.

AMS [List of AMS Sources]

This selects an AMS source to control the **SPEED**. For a list of AMS sources, see “Alternate Modulation Source (AMS) List” on page 903.

Intensity [-10.0...+10.0]

This controls the depth and direction of the **SPEED** AMS modulation.

INTENSITY [00.0...10.0]

Not to be confused with AMS Intensity, this knob (named the same as on the original instrument) controls the depth of the Vibrato effect. The default is 5.0.

AMS [List of AMS Sources]

This selects an AMS source to control the **Intensity**. For a list of AMS sources, see “Alternate Modulation Source (AMS) List” on page 903.

Intensity [-10.0...+10.0]

This controls the depth and direction of the **Intensity** AMS modulation.

5-1h: Amp & Cabinet

ON/OFF [On, Off]

This enables the amp and cabinet modeling.

AMS [List of AMS Sources]

This selects an AMS source to turn the amp and cabinet model on or off. For a list of AMS sources, see “Alternate Modulation Source (AMS) List” on page 903.

AMS Mode [Toggle, Momentary]

This controls the way in which the amp and cabinet **Enable** AMS works. For more information, please see “AMS Mode” on page 367.

DRIVE [00.0...10.0]

This controls the amount of overdrive and distortion in the amp. At lower settings, the amp is very clean; as you increase the **DRIVE**, it gets dirtier and more distorted. The output level is compensated, so increasing **DRIVE** causes only a moderate increase in perceived volume.

AMS [List of AMS Sources]

This selects an AMS source to control the **DRIVE**. For a list of AMS sources, see “Alternate Modulation Source (AMS) List” on page 903.

Intensity [-10.0...+10.0]

This controls the depth and direction of the **DRIVE** AMS modulation.

Reed EP

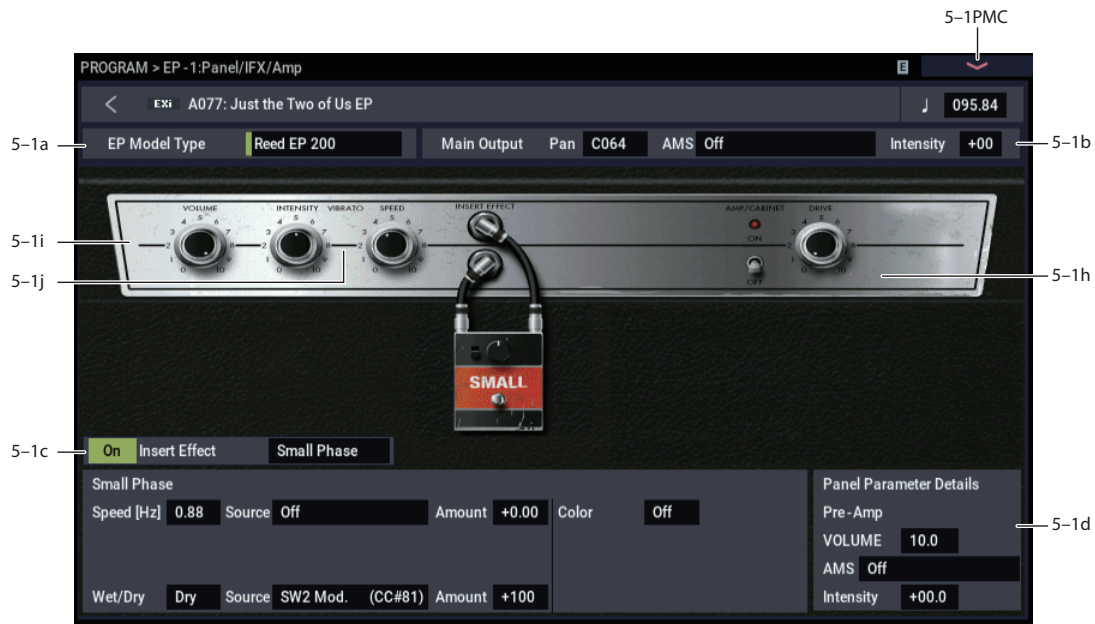

These parameters apply when the **EP Model Type** is set to either **Reed 200** or **Reed 200a**.

5-1i: Pre-amp

VOLUME [00.0...10.0]

This controls the volume level. The default is 8.0.

AMS [List of AMS Sources]

This selects an AMS source to control the **VOLUME**. For a list of AMS sources, see “Alternate Modulation Source (AMS) List” on page 903.

Intensity [-10.0...+10.0]

This controls the depth and direction of the **VOLUME** AMS modulation.

5-1j: Vibrato

INTENSITY [00.0...10.0]

This controls the depth of the vibrato effect. To turn off the vibrato completely, set **INTENSITY** to **00.0**. (The original instrument had only a knob, without a separate on/off switch.)

AMS [List of AMS Sources]

This selects an AMS source to control the **INTENSITY**. For a list of AMS sources, see “Alternate Modulation Source (AMS) List” on page 903.

Intensity [-10.0...+10.0]

This controls the depth and direction of the **INTENSITY** AMS modulation.

SPEED [00.0...10.0]

This controls the rate of the vibrato effect. On the original instrument, **SPEED** wasn’t adjustable; 5.0 on this knob matches the original value.

AMS

[List of AMS Sources]

This selects an AMS source to control the **SPEED**. For a list of AMS sources, see “Alternate Modulation Source (AMS) List” on page 903.

Intensity [-10.0...+10.0]

This controls the depth and direction of the **SPEED** AMS modulation.

5-1k: Amp & Cabinet

This section is the same as for the Tine Piano, as described under “5-1h: Amp & Cabinet” on page 368.

Insert Effects

The parameters vary depending on the selected effect.

Small Phase

This classic phaser, made in New York City during the 70s, has a notably warm and rich tone with liquid transparency.

Speed [Hz] [0.10...10.00]

This controls the speed of the phaser's LFO. The default is 0.56 Hz.

Source [List of Dmod Sources]

This selects a mod source to control the **Speed**. For a list of Dmod sources, see the "Dynamic Modulation Source List" on page 912.

Amount [-10.0...+10.0]

This controls the depth and direction of the **Speed** modulation.

Color [Off, On]

This changes the sound of the phaser between a full and round phase shift when set to **Off**, and a more pronounced effect when set to **On**.

OUTPUT

Wet/Dry  [Dry, 1:99...99:1, Wet]

Sets the balance between the "wet" processed sound and the dry input.

Source [List of Dmod Sources]

This selects a modulation source to control the **Wet/Dry** balance.

Amount [-100...+100]

This controls the depth and direction of the **Wet/Dry** modulation.

Orange Phase

This phaser pedal is a favorite on many recordings. It's useful for adding sparkle, animating chord passages, and widening and fattening the sound.

The original had only a speed control; this version adds depth, control of the center frequency, and more.

Speed [Hz] [0.10...10.00]

This controls the speed of the phaser's LFO. The default is 1.00 Hz.

Source [List of Dmod Sources]

This selects a modulation source to control the **Speed**. For a list of Dmod sources, see the "Dynamic Modulation Source List" on page 912.

Amount [-10.0...+10.0]

This controls the depth and direction of the **Speed** modulation.

Depth  [0...100]

Sets the depth of LFO modulation.

Source [List of Dmod Sources]

This selects a modulation source to control the LFO modulation **Depth**.

Amount [-100...+100]

This controls the depth and direction of the **Depth** modulation.

Resonance [000...100]

This controls the intensity of the phaser effect. The default is 26. Mixing the processed and dry signals via **Wet/Dry** will enhance the effect.

Manual [1...100]

This sets the center frequency of the phaser. The default is 45.

OUTPUT

This is the standard effects output section, with modulatable control over wet/dry balance. For more information, see "OUTPUT" on page 370.

Black Phase

Inspired by a classic European phaser pedal.

Speed [Hz] [0.10...10.00]

This controls the speed of the phaser's LFO. The default is 1.0Hz.

Source [List of Dmod Sources]

This selects a modulation source to control the **Speed**. For a list of Dmod sources, see the "Dynamic Modulation Source List" on page 912.

Amount [-10.0...+10.0]

This controls the depth and direction of the **Speed** modulation.

Depth  [0...100]

Sets the depth of LFO modulation.

Source [List of Dmod Sources]

This selects a modulation source to control the LFO modulation **Depth**.

Amount [-100...+100]

This controls the depth and direction of the **Depth** modulation.

Resonance [000...100]

This controls the intensity of the phaser effect. The default is 26. Mixing the processed and dry signals via **Wet/Dry** will enhance the effect.

Manual [1...100]

This sets the center frequency of the phaser. The default is 45.

OUTPUT

This is the standard effects output section, with modulatable control over wet/dry balance. For more information, see "OUTPUT" on page 370.

Vintage Chorus

This models a chorus best-known for being built into a guitar amp. You can use the **Speed** and **Depth** knobs for an even broader range of possibilities than on the original device.

Speed [Hz] [0.10...10.00]

This controls the speed of the chorus' LFO. The default is 0.48 Hz.

Source [List of Dmod Sources]

This selects a modulation source to control the **Speed**. For a list of Dmod sources, see the "Dynamic Modulation Source List" on page 912.

Amount [-10.0...+10.0]

This controls the depth and direction of the **Speed** modulation.

Depth D^{mod} [0...100]

Sets the depth of LFO modulation. The default is 58.

Source [List of Dmod Sources]

This selects a modulation source to control the **Depth**.

Amount [-100...+100]

This controls the depth and direction of the **Depth** modulation.

Manual [1...100]

This adjusts the offset of the LFO sweep, effectively increasing the center delay time of the chorus. The default is 1.

When **Depth** is set to the maximum of **100**, this has no effect.

OUTPUT

Output Mode [Mono, Stereo]

The chorus can function either in mono or stereo.

Wet/Dry D^{mod} [Dry, 1: 99...99:1, Wet]

Sets the balance between the "wet" processed sound and the dry input. The default is 50:50.

Source [Off...Tempo]

Selects a modulation source for **Wet/Dry**.

Amount [-100...+100]

Sets the modulation amount for **Wet/Dry**.

Black Chorus

Modeled after a classic stereo chorus known for both crystal-clean tone and quiet operation, and especially well-suited to fine electric pianos.

Speed [Hz] [0.10...10.00]

This controls the speed of the LFO. The default is 0.8 Hz.

Source [List of Dmod Sources]

This selects a modulation source to control the **Speed**. For a list of Dmod sources, see the "Dynamic Modulation Source List" on page 912.

Amount [-10.0...+10.0]

This controls the depth and direction of the **Speed** modulation.

Intensity D^{mod} [1...100]

This controls different things, depending on the **Mode** setting. The default is 66.

When **Mode** is set to Chorus, **Intensity** blends between the wet and dry signals.

When **Mode** is set to Pitch Modulation, **Intensity** blends between chorus (at 0) and vibrato (at 100).

When **Mode** is set to Flanger, **Intensity** controls the feedback amount.

Source [List of Dmod Sources]

This selects a modulation source to control the **Intensity**.

Amount [-100...+100]

This controls the depth and direction of the **Intensity** modulation.

Width [0...100]

This controls the amount of LFO modulation. The default is 58.

Source [List of Dmod Sources]

This selects a modulation source to control the **Width**.

Amount [-100...+100]

This controls the depth and direction of the **Width** modulation.

Mode [Chorus, Pitch Modulation, Flanger]

This controls the basic sound of the effect.

Chorus is a standard chorus sound.

Pitch Modulation is a lighter chorus effect.

Flanger adds feedback, for more extreme timbres.

Input Gain [0...100]

This controls the input into the effect. High levels will add saturation.

OUTPUT

Output Mode [Mono, Stereo]

This controls whether the output is stereo or mono. When set to **Stereo**, the left-right spread is controlled by the **Width** parameter.

Wet/Dry  **[Dry, 1: 99...99:1, Wet]**

Sets the balance between the “wet” processed sound and the dry input. The default is **Wet**.

Note: When **Mode** is set to **Chorus**, the Intensity control is the same as **Wet/Dry**.

Source **[List of Dmod Sources]**

Selects a modulation source for **Wet/Dry**.

Amount **[-100...+100]**

Sets the modulation amount for **Wet/Dry**.

EP Chorus

This is inspired by a rare chorus built into an early version of a famous modified tine piano.

Speed [Hz] **[0.10...10.00]**

This controls the speed of the chorus’ LFO. The default is 1.96 Hz.

Source **[List of Dmod Sources]**

This selects a modulation source to control the **Speed**. For a list of Dmod sources, see the “Dynamic Modulation Source List” on page 912.

Amount **[-10.0...+10.0]**

This controls the depth and direction of the **Speed** modulation.

Depth  **[0...100]**

This sets the depth of LFO modulation. The default is 55.

Source **[List of Dmod Sources]**

This selects a modulation source to control the **Depth**.

Amount **[-100...+100]**

This controls the depth and direction of the **Depth** modulation.

OUTPUT

This is the standard effects output section, with modulatable control over wet/dry balance. For more information, see “OUTPUT” on page 370.

Vintage Flanger

A model of a truly classic analogue flanger. This amazing stompbox’s bucket-brigade technology provides a sweeping, whooshing sound, perfect for chords.

Speed [Hz] **[0.10...10.00]**

This controls the speed of the LFO. The default is 0.14Hz.

Source **[List of Dmod Sources]**

This selects a modulation source to control the **Speed**. For a list of Dmod sources, see the “Dynamic Modulation Source List” on page 912.

Amount **[-10.0...+10.0]**

This controls the depth and direction of the **Speed** modulation.

Depth  **[0...100]**

Sets the depth of LFO modulation. The default is 71.

Source **[List of Dmod Sources]**

This selects a modulation source to control the **Depth**.

Amount **[-100...+100]**

This controls the depth and direction of the **Depth** modulation.

Resonance **[0...100]**

This controls the intensity of the flanger effect, via feedback. The default is 35.

Manual **[1...100]**

This adjusts the offset of the LFO sweep, effectively increasing the center delay time of the chorus. The default is 35.

When **Depth** is set to the maximum of **100**, this has no effect.

Source **[List of Dmod Sources]**

This selects a modulation source to control the **Manual** amount.

Amount **[-100...+100]**

This controls the depth and direction of the **Manual** modulation.

LFO Reset Source **[List of Dmod Sources]**

This selects a modulation source to reset the LFO. You can use this to re-start the flanger’s jet-like, rolling motion just before a big power chord, for instance. This will be most useful when the **Speed** is set relatively low.

Reset Offset Amount **[0...100]**

This controls the phase of the LFO when reset.

OUTPUT

This is the standard effects output section, with modulatable control over wet/dry balance. For more information, see “OUTPUT” on page 370.

Red Compressor

Need to play clean chordal passages with smooth, even dynamics? Then, look no further: this compressor is modeled on a pedal whose clean sound made it hugely popular. Perfect for pop and funk music.

Sensitivity **[1...100]**

This controls the amount of compression. Increasing the value boosts lower level sounds, and raises the overall volume. The default is 50.

To adjust the final volume, use the **Output Level** parameter.

Attack **[1...100]**

This controls the onset time of the compressor. The default is 25.

Level **[0...100]**

Compression reduces the overall gain of the signal. This allows you to compensate for that effect, by boosting the gain again at the output. The default is 50.

OUTPUT**Wet/Dry**  **[Dry, 1:99...99:1, Wet]**

Sets the balance between the “wet” processed sound and the dry input. The default is **Wet**.

Source **[List of Dmod Sources]**

Selects a modulation source for **Wet/Dry**.

Amount **[-100...+100]**

Sets the modulation amount for **Wet/Dry**.

VOX Wah

This effect is modeled on two legendary VOX wah pedals: the V847 and the V848 Clyde McCoy model. Thanks to their unique “throaty” tone, these are the only wah pedals that many professionals will consider putting under their feet. Played musically, they can make your melody lines cry like a baby—or howl like a man possessed!

A great tonal trick is to find a “sweet spot” within the range of the Wah pedal and then leave it there. This “stuck-Wah” can be very effective when used tastefully, producing a distinctive sound that will cut through any mix.

Type **[V847, V848]**

This selects the pedal model.

V847 has a rounder sound; **V848** (the default) has a more aggressive sound.

Open **[1...100]**

This sets the wah frequency when the pedal is up. The default is 36.

Close **[1...100]**

This sets the wah frequency when the pedal is down. The default is 40.

Mode **[Pedal Wah, Auto Wah]**

This controls the basic operation of the wah, and also determines which parameters appear below.

Auto Wah makes the wah follow the input signal’s volume envelope. This is the default.

Pedal Wah lets you control the wah frequency directly via a modulation source, just like a wah pedal.

Pedal Wah

These parameters appear only when the **Mode** is set to **Pedal Wah**.

Pedal Source **[List of Dmod Sources]**

This selects a modulation source to control the wah frequency. The default is JS+Y, but you can also use a real pedal if you have one connected!

Pedal Manual **[1...100]**

This sets the default value of the pedal, before the selected modulation source is moved. Once the source has been moved, **Pedal Manual** has no effect. The default is 84.

Auto Wah

These parameters appear only when the **Mode** is set to **Auto Wah**.

Auto Sensitivity **[0...100]**

This sets the sensitivity of auto-wah. Increase the value if the input signal is too low to sweep the wah. Reduce the value if the input signal is so high that the sweep stops temporarily. The default is 18.

Auto Attack **[1...100]**

This controls the reaction time of the auto-wah. The default is 10.

Auto Polarity **[Up, Down]**

This controls whether the auto-wah sweeps from open to closed, or from closed to open. The default is **Up**.

OUTPUT**Wet/Dry**  **[Dry, 1:99...99:1, Wet]**

Sets the balance between the “wet” processed sound and the dry input. The default is **Wet**.

Source **[List of Dmod Sources]**

Selects a modulation source for **Wet/Dry**.

Amount **[-100...+100]**

Sets the modulation amount for **Wet/Dry**.

✓ 5-1: Page Menu Commands

- Compare →p.112
- Write Program →p.112
- Exclusive Solo →p.113
- PAGE →p.126
- MODE →p.126

EXi PROGRAM > EP-1: AMS Mixers

The EP-1's AMS Mixers are identical to those of the AL-1. For detailed explanations, please see "9-1: AMS Mixer," on page 179.

EP-1: Tone Adjust

EP-1 Tone Adjust Default Settings

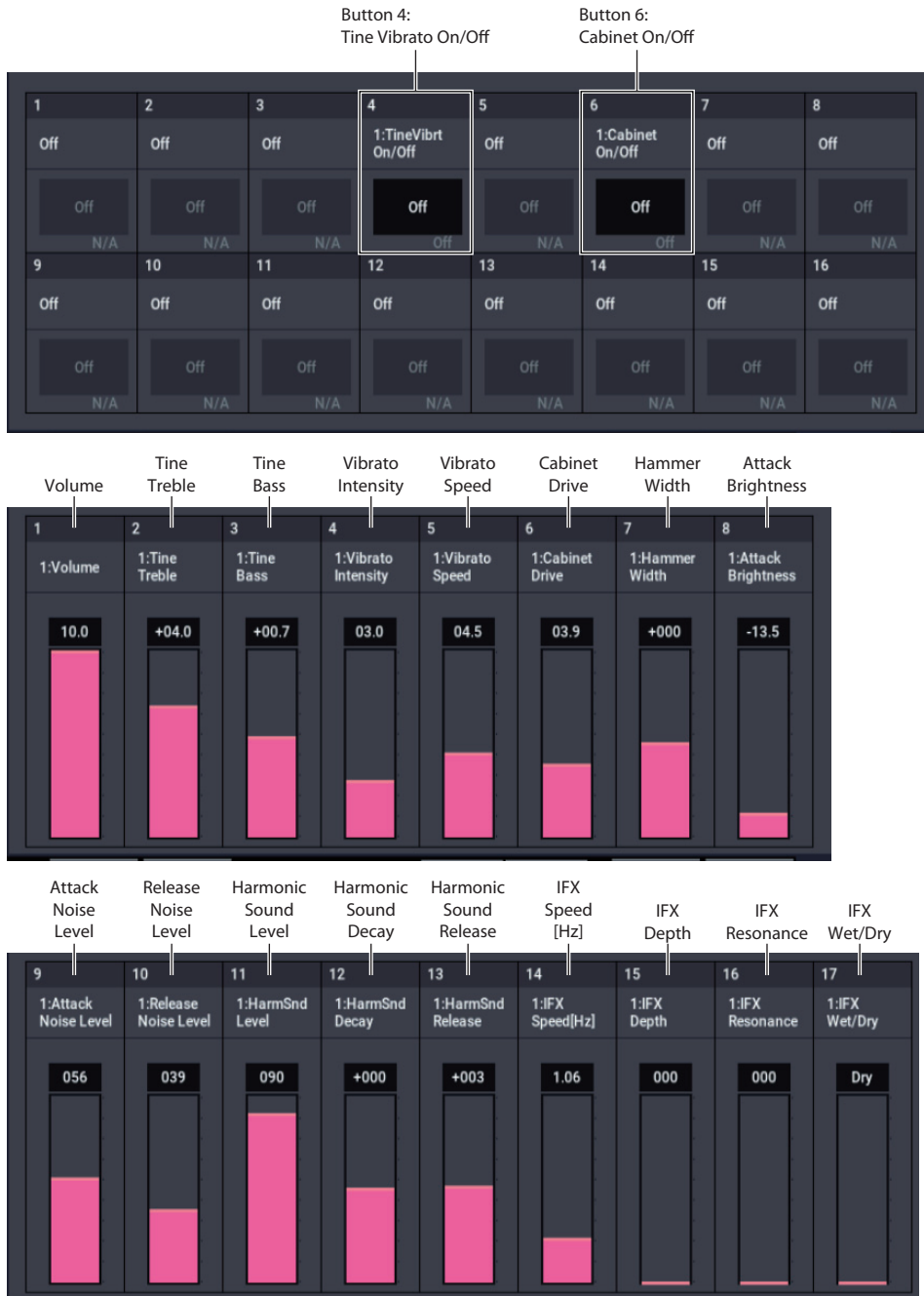

Common Tone Adjust parameters

The EP-1 supports the following Common Tone Adjust parameters:

Off. This means that the Tone Adjust control has no effect.

Common LFO Speed. (-99...+99, Relative)

This scales the EXi Program’s Common LFO **Frequency**. When the LFO is in MIDI/Tempo mode, this adjusts the **Base Note**.

Common Step Sequencer Attack Smoothing. (00...99, Absolute)

This **Absolute** parameter sets amount of attack smoothing for the Common Step Sequencer. For more information, please see “Smoothing” on page 137.

Common Step Sequencer Decay Smoothing. (00...99, Absolute)

This **Absolute** parameter sets amount of decay smoothing for the Common Step Sequencer. For more information, please see “Smoothing” on page 137.

EP-1 Tone Adjust parameters

In addition to the Common Tone Adjust parameters listed above, the EP-1 adds a number of its own parameters.

Note that these additional parameters are separate for each EXi, as opposed to being shared by both EXi in the Program.

All of the EP-1 Tone Adjust parameters are of the **Absolute** type, which directly correspond to the main parameter values.

Some parameters with longer names may show an abbreviation for the slider, and switch labels.

Oscillator

Harmonic Sound Level
Harmonic Sound Decay
Harmonic Sound Release
Attack Noise Level
Release Noise Level
Attack Brightness
Hammer Width

Panel

Volume
Tine Treble
Tine Bass
Tine Vibrato On/Off
Vibrato Speed
Vibrato Intensity
Cabinet On/Off
Cabinet Drive

Insert Effects

IFX Speed [Hz]
IFX Depth
IFX Resonance
IFX Attack
IFX Wet/Dry

EXi EP-1: Page Menu Commands

| | |
|----------------|--------|
| Compare | →p.112 |
| Write Program | →p.112 |
| Exclusive Solo | →p.113 |
| PAGE | →p.126 |
| MODE | →p.126 |

COMBINATION mode

This is the main page of COMBINATION mode. Among other things, you can:

- Select combinations
- Make edit ARP, Drum truck/Step sequencer to Scene
- Make audio input and resampling settings for use in COMBINATION mode

COMBINATION > Home

0-1: Mixer



This is the main page for selecting and playing Combinations. You can also set the Program, status, pan, and volume for each of the 16 Timbres.

Tips: Press the EXIT button to select “Combination Select” on the Home page. Pressing the EXIT button will bring you to the next step (in the longest case).

Other pages besides Home

→The parameters on the last page you selected in the Home page

→“Combination Select” on the Home - Mixer page

0-1a: Combination Select

Combination Select

[000...127]

Here you can select the desired Combination.

Favorite

[Off, On]

On (checked): The selected Program(s) will be added to the favorites.

For more information, see “Favorite” on page 7.

J (Tempo)

[040.00...300.00, EXT]

This is the tempo for the current Program, which applies to tempo-synced LFOs and Wave Sequences, Arpeggiator, Drum Track, and tempo-synced effects.

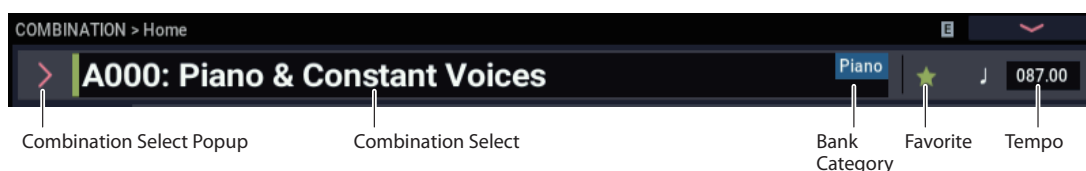

040.00...300.00 allow you to set a specific tempo in BPM, with 1/100 BPM accuracy. In addition to using each VALUE controller, or by playing a few quarter-notes on the TAP button. To set values below the decimal point, hold down the ENTER button and input the value with the VALUE controller.

EXT means that the tempo will sync to external MIDI clocks. You'll see this if the Global MIDI page MIDI Clock parameter is set to External MIDI or USB, or if it's set to Auto MIDI or Auto USB and the NAUTILUS is currently receiving MIDI clocks. For more information, please see "MIDI Clock (MIDI Clock Source)" on page 653.

0-1b: Status Play/Mute

Selected Timbre Info

This area shows information on the timbre selected for editing. Timbre number/program bank/number/name.

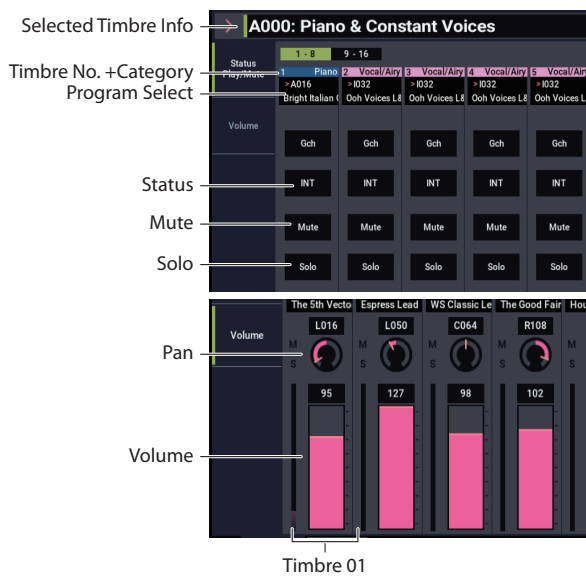

Gray color and [Inactive] warning in Timbre Info

If the background is gray, instead, this means that the maximum amount of EXi Fixed Resources has been exceeded, and the EXi Program assigned to the Timbre will be muted and inactive.

For more information on this subject, including ways to get more out of the system, see "CX-3 & other EXi: Limitations on EXi fixed resources" on page 380.

"Samples Not Loaded" message

If the Timbre's Program uses one or more EXs Multisamples, Samples, or Drum Samples which are not currently loaded, it will not sound correctly. As an indication of this, the message "Samples Not Loaded" will appear at the top of the display. To fix this, load the required EXs sample data.

Timbre 01 (Timbre Number)

This indicates the timbre number. Below each timbre number are shown various parameters which you can edit for that timbre.

Category

When the timbre status is "INT", the Program category used by the timbre is displayed. The background color also differs for each Program category.

The timbre status displays as "Ext" for "EXT", and "Ex2" for EX2. The background color will change to dark gray.

Program Select [0...127 (INT and USER Banks), 1...128 (GM Banks)]

Here you can select the program used by each timbre. The lower line displays part of the program name.

To switch the program of a timbre

- Choose Program Select and turn the VALUE dial or use the +/- buttons.
- From the Bank/Program Select menu you can view and select programs by bank.
- From the Category/Program Select menu you can view and select programs by category.
- In the Bank/Combination Select menu or Category/Program Select menu, you can use the Favorite function to view and select programs whose "Favorite" setting is check.
- You can transmit MIDI program changes from a connected external MIDI device.

MIDI When you select a Combination on the NAUTILUS, a MIDI program change for the selected combination number will be transmitted on the global MIDI Channel (GLOBAL 1-1a). At the same time, bank select, program change, and volume (CC#7) messages will be transmitted on the MIDI channel specified for each timbre whose Status (0-1b, 2-1a) is set to EXT or EX2. However, these messages will not be transmitted for timbres that are set to the same MIDI channel as the global MIDI channel. In this case, EX2 timbres will show the "Program" Bank as "-", and will transmit the bank number that was specified in "Bank Select" (2-1a).

When you play on the NAUTILUS keyboard and controllers, MIDI messages are transmitted on the global MIDI channel. At the same time, timbres whose Status is set to EXT or EX2 will transmit the same messages on their own MIDI channel.

If bank select and program change messages are received on a MIDI channel that matches the MIDI channel of a timbre whose Status is INT, the program of that timbre will change. However if the MIDI channel of the incoming message matches the global MIDI channel "MIDI Channel," then the combination will change.

If you do not want the combination to change, you can either change the global MIDI channel so that it does not match the channel on which the program change messages are being received, or you can uncheck "Combination Change" (GLOBAL 1-1c). You can also uncheck "Bank Change" so that only the program number will change and the bank will remain the same.

If you wish to change the program assigned to certain timbres without changing the combination, you can also set Enable Program Change (3-1a) so that the program will change on certain timbres but not on others.

Status [Off, INT, EXT, EX2]

This sets whether the Timbre controls the internal sounds, or external MIDI devices.

When controlling external MIDI devices, it also allows you to choose between using the internal Bank Select numbers (as set by the front-panel buttons), or using custom Bank Select settings to match the external device.

Off: Use this to disable the Timbre. With this setting, the Timbre’s Program will not sound, and MIDI data will not be transmitted. Also, any EXi fixed resources used by the Program will be freed.

Note: When the status is “Off”, the timbre displays as a positive value. Pressing the + button enables the timbre, with the timbre status set to “INT”, and “MIDI” set to “Gch”.

INT: Use this to make the Timbre play internal sounds. With this setting, the Timbre’s Program will respond to both the local keyboard and MIDI input on the Timbre’s MIDI channel. The Timbre will not transmit MIDI data.

EXT: Use this to play an external MIDI device, with Bank Select via the front-panel Bank buttons. With this setting, the Timbre’s Program will not respond to either the local keyboard or MIDI input. MIDI will be transmitted to external devices on the selected MIDI channel.

EX2: Use this to play an external MIDI device, with custom-set Bank Select via the **Bank Select LSB** and **MSB** parameters, on the **MIDI** tab of the **Timbre Parameters** page. In all other ways, this is the same as **EXT**.

For more information, see “Bank Select MSB (When Status = EX2)” on page 405.

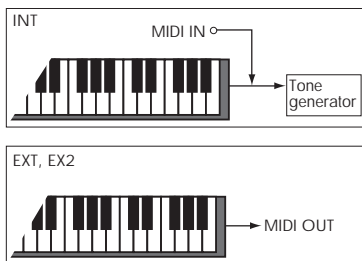

Mute [On, Off]

Timber will be muted.

Solo [On, Off]

This setting switches the Solo function on/off.

Only timbres that are set to Solo On will be heard. Other timbres (and audio inputs: 0-8a) will be muted.

The setting will alternate each time you press the Solo button.

MIDI Timbres that have been silenced by the Mute or Solo functions will not transmit note-on/off messages on the MIDI channel assigned for their track when the timbre’s **Status** (2-1a) is Both, EXT, or EX2.

The Solo function operates differently depending on the setting of the **Exclusive Solo** page menu command. If Exclusive Solo is off, you can turn Solo on for more than one timbre.

If Exclusive Solo is on, pressing a Solo button will turn Solo on for only that timbre.

Solo settings are not preserved when you write a combination.

0-1c: Volume

Pan [RND, L001...C064...R127]

This specifies the pan of each timbre.

L001...C064...R127: A setting of L001 is far left and R127 is far right. A setting of C064 will reproduce the pan setting of the PROGRAM mode.

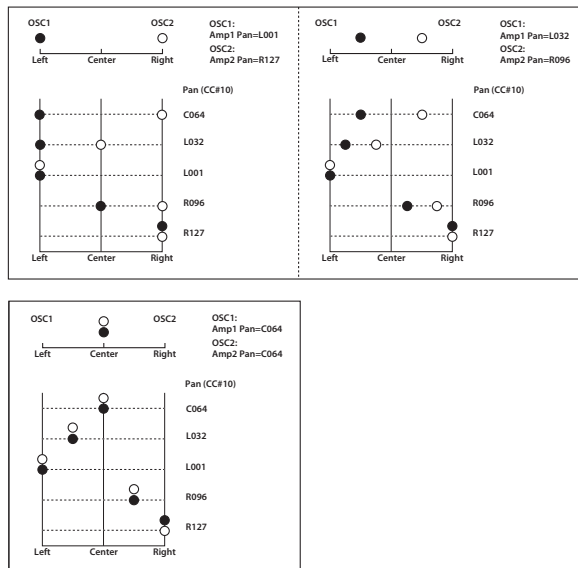

If a mono insert effect is in use, the settings you make here will be ignored. In this case, the “Pan (CC#8)” parameter in IFX- Insert FX page will adjust the panning of the sound after the insert effect (“Mixer” on page 748).

RND: The oscillator pan will change randomly at each note-on.

MIDI If **Status** (2-1a) is set to INT, CC#10 (pan) messages can be received to control the setting. CC#10 values of 0 or 1 will place the sound at far left, 64 at center, and 127 at far right. (exclude RND) Pan can be controlled by messages received on the **MIDI Channel** (2-1a).

Volume [000...127]

This fader adjusts the volume of the Timbre. The meter to the left of the fader displays its audio level in realtime, showing the combined peak signals of the left and right channels.

MIDI The volume of each timbre is determined by multiplying this volume value with the MIDI volume (CC#7) and expression (CC#11).

If **Status** (0-1b, 2-1a) has been set to INT, incoming MIDI CC#7 or CC#11 messages will control the volume of a timbre. (However these messages will not affect the setting of this parameter.)

If **Status** is EXT or EX2, the value of this parameter will be transmitted as MIDI CC#7 when the combination is changed. However this will not be transmitted by a timbre that is set to the same MIDI channel as the global MIDI channel. This message is transmitted on the **MIDI Channel** (2-1a) specified for each timbre.

Timbre 02... 16 (Timbre Number)

Here you can specify the program etc. for each Timbre 2 through 16. These settings are the same as for Timbre 1, as described above.

CX-3 & other EXi: Limitations on EXi fixed resources

Dynamic resources and fixed resources

NAUTILUS processing power is shared between synthesizer voices and effects.

Synthesizer voices typically use *dynamic* resource allocation, so that they primarily use processing power when notes are being played. Effects, on the other hand, use *fixed* allocation; once you call up an effect in an IFX, MFX, or TFX slot, it always uses processing power, whether or not any audio is passing through it.

Many of the EXi also include effects or other fixed components, which take up a small amount of processing power even when voices are not being played. We call these “EXi fixed resources.”

EXi with fixed resources

The HD-1 and AL-1 are completely dynamic. All other EXi use some amount of fixed resources.

The CX-3 uses the most, incorporating substantial fixed elements—such as the built-in rotary speaker, amp, and vibrato chorus—along with dynamically allocated individual voices. The fixed elements take up a reasonable amount of processing power, while each additional voice uses only a small amount more.

The EP-1 also uses a moderate amount of processing power for its amp and effects. The remaining EXi all use a much smaller amount of fixed resources, for features such as built-in effects or audio inputs.

Performance Meters

The Performance Meter page gives an overview of the system resource usage, including the current amount of EXi fixed resources. For more information, see “0–2: Performance Meters” on page 389.

Limits on usage of fixed resources

When you load an EXi which uses fixed resources, the fixed elements start using processing power immediately. To leave room for dynamic voices, the NAUTILUS limits EXi fixed resources to a maximum of 50% of the voice processing power. Individual Programs can’t exceed this amount, but it’s possible to hit the limit when using many CX-3 or EP-1 Programs in a Combination or Song.

For instance, you can use up to eight CX-3s simultaneously, or eighteen EP-1s, or a combination of the two (e.g., four CX-3s and nine EP-1s). The other EXi have no practical limitation by themselves, but if you’re using a lot of CX-3 or EP-1 Programs you may run into situations in which the less-resource-intensive EXi would push the resource usage over the top.

Each EXi in each Program counts towards the maximum. For instance, a Program which uses two CX-3s counts as two, not as one.

Note that depending on the specific combination of EXi in use, you may not be able to fit in more EXi Programs (especially those using the CX-3 or EP-1) even if the Performance Meter page shows EXi fixed resources at somewhat below 50%.

Gray Timbre/Track number, and [Inactive] shown after Program name

If you try to load a Program which would exceed the maximum amount of EXi fixed resources, the newly added Program will not sound.

To let you know that this has happened, the bar containing the Timbre/Track number (at the top of the mixer channel) will turn gray.

You can re-enable an inactive Program by removing or disabling other Programs which use EXi fixed resources. For instance:

1. **Select an initialized Combination (“Init Combination”).**
2. **Load Program F003: HD-1 Piano-Damper into all of the Timbres.**
3. **Load Program B067: Felix’s Da Kat into Timbres 1 through 8.**

This Program uses a single CX-3, so loading it into eight separate Timbres uses up all of the available EXi fixed resources.

4. **Load the same Program (B067: Felix’s Da Kat) into Timbre 9.**

Since there are no remaining EXi fixed resources, the Timbre number will turn gray, and the Program won’t make any sound. Let’s fix that:

5. **Set Timbre 1’s Status to Off**
or
Change Timbre 1 to use an HD-1 or AL-1 Program (such as E000), instead of a CX-3.

This frees up the EXi fixed resources formerly used by Timbre 1; Timbre 9 will then return to its normal color, and its Program will make sound again.

These same steps will work with Tracks in SEQUENCER mode.

Use Program Changes to optimize resource usage

If you’re using NAUTILUS for multitimbral sequencing (with different Programs on different MIDI channels), you can optimize the EXi fixed resource usage by only having these Programs loaded when they are needed.

For instance, if you’re playing a CX-3 only during the chorus of a song, you can use Program Change to switch that channel to an HD-1 or AL-1 Program during the verse.

Neither the HD-1 nor the AL-1 uses fixed resources, so this will free up NAUTILUS computing power. You can then use this power for more voices of other sounds, or for other EXi with fixed resources on different Timbres or Tracks.

0-1d: Quick Layer and Quick Split buttons

These buttons access the Quick Layer and Quick Split features, which make it easy to create simple layers and splits. Starting with either a Program or Combination, you can add another Program as a layer, or split the keyboard so that the current sound plays on one side of the keyboard (either upper or lower), and a different Program plays on the other.

When you press the Quick Layer or Quick Split buttons, the Quick Layer or Quick Split dialog box appears. For detailed descriptions, see “Quick Layer” on page 384 and “Quick Split” on page 387.

To switch combinations

- Choose “Combination Select” and turn the VALUE dial or use the +/- buttons.
- From the Bank/Combination Select menu you can view and select combinations by bank.
- From the Category/Combination Select menu you can view and select combinations by category.
- In the Bank/Combination Select menu or Category/Combination Select menu, you can use the Favorite function to view and select combinations whose “Favorite” setting is on.
- You can use a foot switch to select combinations. For more information, see the Global parameter “Foot Switch Assign” on page 675. For a list of the functions that can be assigned to the footswitch, see “Foot Switch Assignments” on page 917.
- You can transmit MIDI program changes from a connected external MIDI device.

Category/Combination Select

You can select combinations by category and sub-category. All combinations are organized into up to eighteen categories, and each category is further organized into eight sub-categories. You can use these categories and sub-categories to select combinations.

1. Press the “Combination Select” popup button to display the Category/Combination Select menu.
2. Press a tab in the left or right column to select a category. You cannot choose a category tab to which no combinations have been assigned.
3. Press a tab in the top of column to select a sub-category.

The Combinations categorized by sub-categories will be displayed.

All: All combinations in the category will be shown. Choose this when you don’t need to use sub-categories.

0...7: The combinations will be shown by sub-category. You cannot select the tab of a sub-category to which no combinations have been assigned.

Select a combination from the list. You can directly press your choice within the list, or use the +/- buttons.

If there are more combinations than can be shown in the screen, use the scroll bar to see the remaining combinations.

4. If you check “Favorite” in the menu, the combinations you marked as Favorites will be shown.

You cannot select this if no combinations in all the categories are marked as Favorites.

5. You can use the Find button to search for Combinations by name.

For more information, see “Find dialog” on page 7.

6. Press the OK button to execute, or press the Cancel button to cancel your selection.

Note: The category of each combination can be specified in the “Write Combination” dialog box.

Category/Combination Select menu

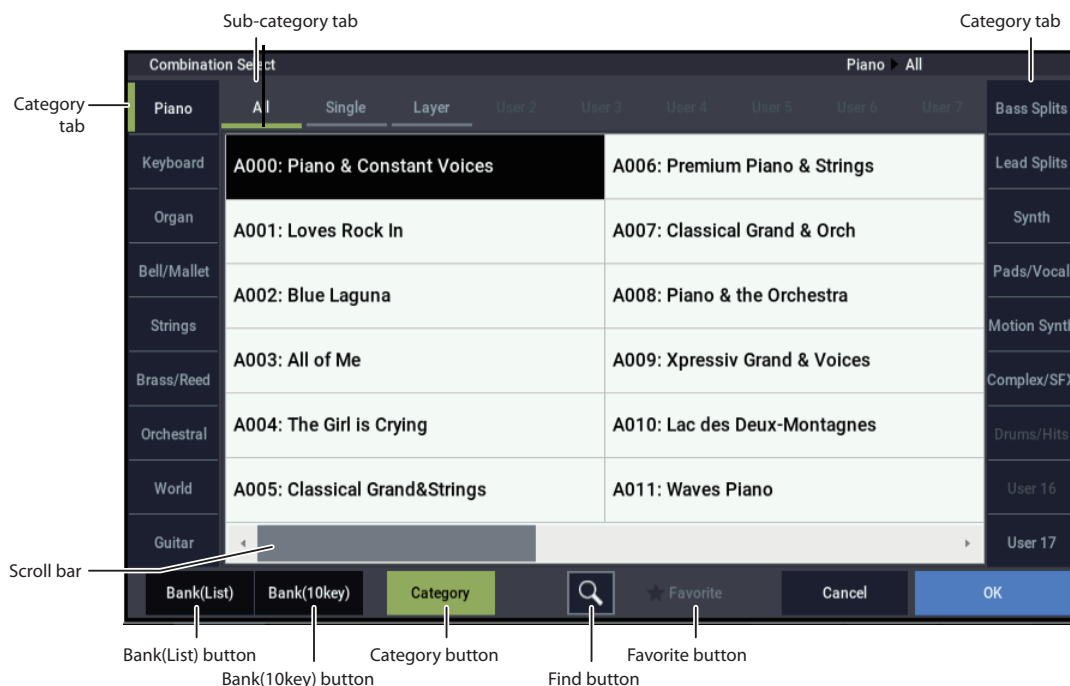

Bank/Combination Select

1. Press the popup button located at the left of “Combination Select” to access the Bank/Combination Select menu.
2. Press one of the tabs at left to select a bank.
3. Select a combination from the list. You can directly press your choice within the list, or use the +/- buttons.

If the screen cannot display all of the available items, use the scroll bar.

4. If you enable the Favorite check-box, the combinations marked as Favorites will be shown.

If the selected bank contains no combinations for which Favorite is turned on, this cannot be chosen.

5. You can use the Find button to search for Combinations by name.

Bank/Combination Select menu

For more information, see “Find dialog” on page 7.

6. Press the OK button to execute, or press the Cancel button to cancel your selection.

Favorite

[Off, On]

On (checked): Turns on the Favorite setting for combinations. Only combinations that you marked as favorites will be shown and can be selected in the Bank/Combination Select menu and Category/Combination Select menu. If you mark frequently-used combinations as Favorites (i.e., check the Favorite setting for those combinations), it will be easy to find them later.

Note that you must write the Combination in order to save changes to this setting.

Find

[Button]

This magnifying-glass button brings up the Find dialog. For more information, see “Find dialog” on page 7.

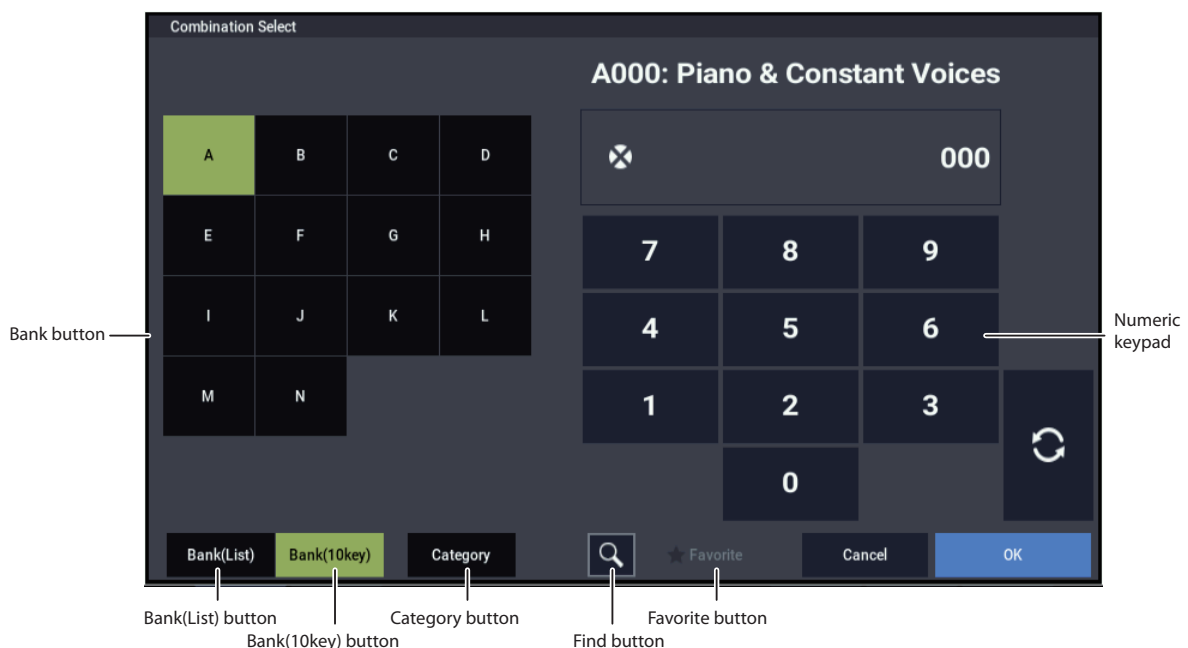
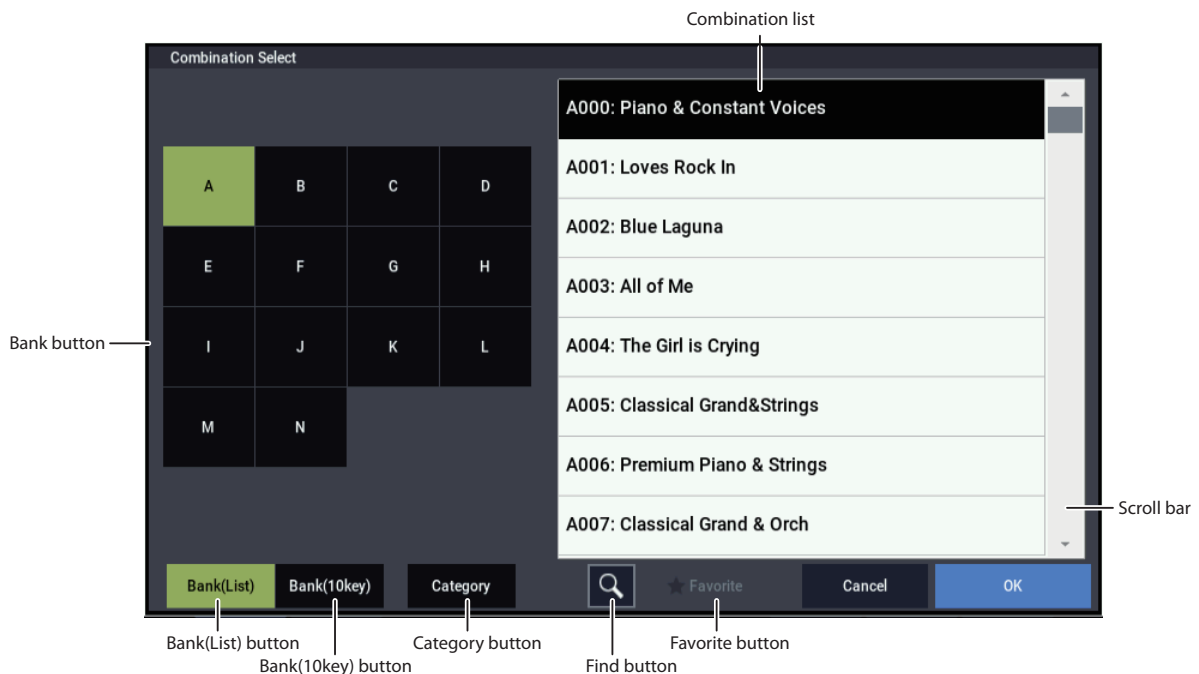

Hold Balance**[Off, On]**

On (checked): When any one of the volume sliders is moved, the volume of the other timbres will change as well. The volume balance of timbres 1-16 will be maintained. This is useful when you wish to adjust the overall volume.

✓ 0-1: Page Menu Commands

- Compare →p.112
- Write Combination →p.433
- Exclusive Solo →p.113
- Copy From Program →p.433
- Add To Set List →p.113
- Load required samples →p.114
- Edit Program →p.434
- Initialize Combination →p.435

- PAGE →p.126
- MODE →p.126

Quick Layer

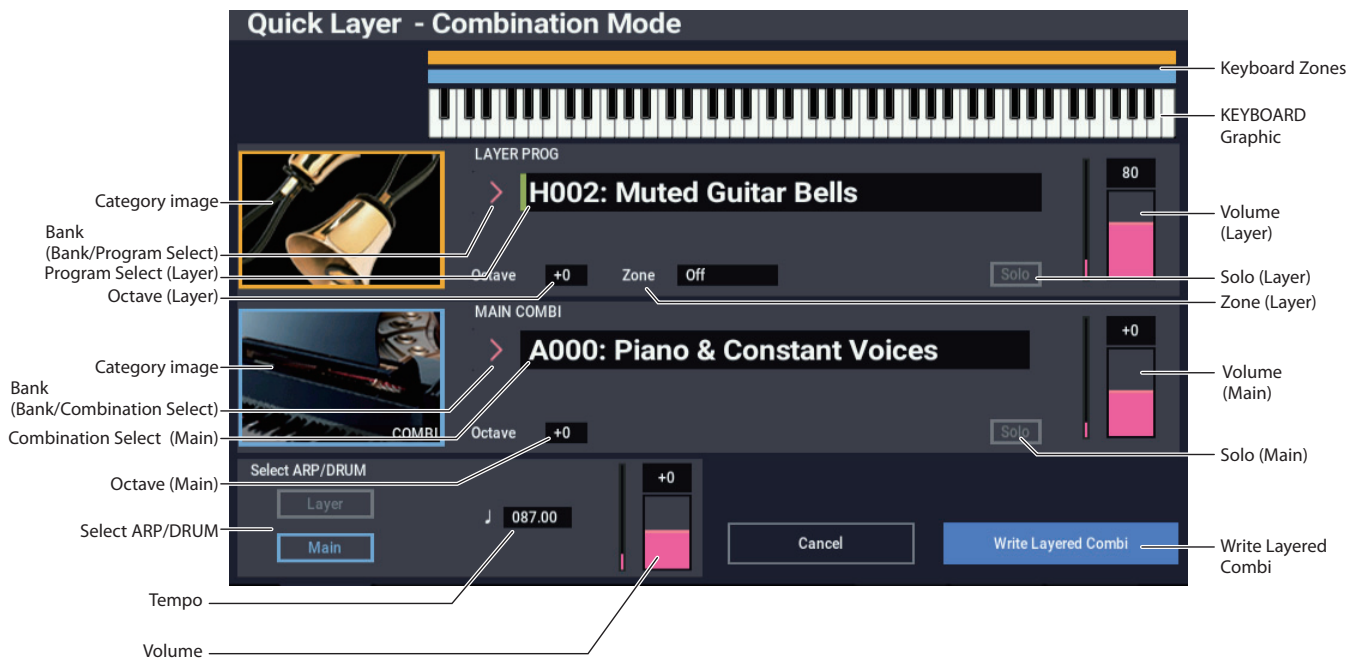

Overview

This dialog box is reached by pressing the Quick Layer button on the COMBINATION > Home page.

A “layer” is when playing a single note causes two or more sounds to be heard simultaneously. When invoked from COMBINATION mode, the Quick Layer function lets you layer a Program with the selected Combination.

All of the Quick Layer controls are non-destructive and reflected immediately when playing on the keyboard. You can experiment with different settings, and fine-tune until you find the perfect sound. Once you’re happy with the results, you can save the layer as a new Combination.

Limitations of Quick Layer/Split in COMBINATION mode

Timbres

The Split or Layer Program is automatically placed in an unused Timbre. If there are additional unused Timbres, they will be muted. If all Timbres are already in use by the Main Combination, the selected Program is put into Timbre 16, replacing whatever was there previously. If this occurs, a caution icon will appear (see “Caution messages,” below), and the Main Combination may not sound exactly the same.

Effects

As long as there are enough insert effect (IFX) slots, the selected Program’s insert effects (IFX) are copied into the Combination, and the Program is routed to them. If there are not enough available IFX slots, the Program’s effects won’t be copied, and a caution icon will appear (see “Caution messages,” below).

The Combination will continue to use its previously assigned Master and Total Effects (MFX and TFX). The Send 1/2 levels of the Layer Program are copied into the

Timbre, but the MFX and TFX themselves are not. This means that the layer Program may not sound exactly the same as it would in PROGRAM mode.

Caution messages

If there are insufficient free IFX slots, Arpeggiators, and/or Timbres to completely merge the two sounds, an exclamation point icon will appear:

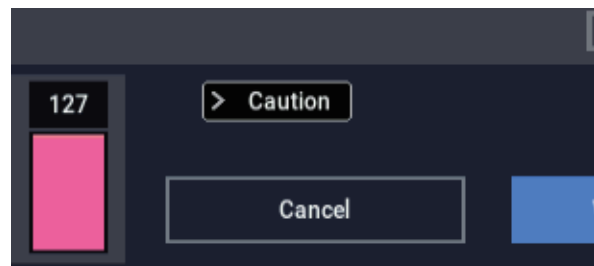

Touch the icon to show information about the specific limitations encountered. Note that these limitations do not prevent the creation of the split or layer sound; they just mean that one or the other of the sounds may not be quite the same when played in the new Combination.

- “There is not enough empty slot to copy Layer’s IFX.”
- “There is not enough empty slot to copy Lower’s/Upper’s IFX.”

This message appears if the insert effect settings of the split/layer Program are not copied because there are not enough insert effect slots.

- “Main’s active T# was replaced for Layer.”
- “Main’s active T# was replaced for Split.”
- “Main’s active T was replaced for Drum Track.”

These messages appear if there are not enough unused Timbres in the Main Combination, and lists the Timbres that were replaced.

Global MIDI Channel

When using Quick Layer in COMBINATION mode, we recommend that the Global MIDI Channel (GLOBAL > MIDI–MIDI) be set to Channel 1. Otherwise, Quick Layer may not work as expected.

Keyboard and Zone Graphics

The graphic at the top of the window shows the keyboard zones of the two sounds. The Layer Program's note range is shown in yellow, and the Main Combination's note range is shown in light blue.

The keyboard graphic shows notes as they are played on the physical keyboard.

LAYER PROG

Layer Program Select [List of Programs]

This selects the Program that is layered onto the main Combination.

Use the “Bank/Program Select”, “Category/Program Select” and “Find” functions to search for banks, categories and keywords.

Note: This automatically searches for timbres not used by the main Combination to set the Layer Programs. Note that if the main Combination does not use all 16 timbres, timbre 16 is set as the Layer Program. For this reason, the main Combination will not sound exactly the same.

Note: Selecting the Layer Program will automatically copy the Layer Program's insert effects. In the same way, the “Send1” and “Send2” values will be copied to the master effect. However, the values will not be copied if there are not enough insert effects available.

For the master and total effects, the main Combination settings are copied. Because of this, the Layer Program will not sound the same in PROGRAM mode.

 The message “> Caution” is shown if there are not enough insert effect slots or Combination timbres. Touch this to open the Quick Layer/Split Caution message, and check which items are insufficient. For more information, see “Caution messages” on page 384.

Category image [graphic]

This display-only graphic represents the category or sub-category of the Layer Program.

Octave [-2, -1, 0, +1, +2]

This adjusts the pitch of the Layer Program in 1-octave units.

Internally, the **Octave** setting controls the Timbre's **Transpose** parameter.

Zone [Off, Lower, Upper]

This limits the region in which the layer Program produces sound.

Off: No limit. The Program will produce sound across the entire range of the keyboard.

Lower: Only the lower notes produce sound.

Upper: Only the upper notes produce sound.

Top Key (or Bottom Key) [C-1...G9]

The name and function of this parameter changes depending on the setting of **Zone**, above.

Top Key appears if **Zone** is set to **Lower**. This sets the *highest* note at which the Layer Program produces sound.

Bottom Key appears if **Zone** is set to **Upper**. This sets the *lowest* note at which the Layer Program produces sound.

Neither parameter is shown if **Zone** is set to **Off**.

You can edit this parameter directly from either the physical keyboard or the keyboard graphic:

1. **Press and hold the ENTER button.**
2. **While holding ENTER, play a note on the keyboard, or touch the keyboard graphic.**

Solo [On, Off]

This turns the Solo function on/off. If Solo is enabled, only tracks with Solo On will sound; other tracks will be muted.

The setting will alternate on/off each time you press the Solo button.

Volume [000...127]

This adjusts the volume of the Layer Program, directly controlling the Timbre's volume slider. The default setting is 80.

MAIN COMBI

Main Combination [List of Combinations]

By default, this will be the currently selected Combination. You can also select a different Combination, if desired. You can use all of the normal Combination selection methods, including bank and number, category, and Find.

Category image

This display-only graphic represents the category or sub-category of the Main Combination.

Octave [-2, -1, 0, +1, +2]

This sets the pitch of the Main Combination in 1-octave units.

Internally, this edits all of the individual Timbre **Transpose** parameters.

Solo [On, Off]

This turns the Solo function on/off. If Solo is enabled, only tracks with Solo On will sound; other tracks will be muted.

The setting will alternate on/off each time you press the Solo button.

Volume [-127...000...+127]

Adjusts the volume of the main Combination. The default value is +000.

+000...-127: Lowers the volume.

+000...+127: Raises the volume.

Note: The values from 0 to +127 will raise the volume until one of the timbre volumes reaches its maximum. When one of the timbres reaches its maximum volume, the volume will not go up any more.

Note: The volume can be set for each timbre in a Combination. This parameter is used to adjust the overall volume while maintaining the volume balance between timbres. For this reason, the value will be reset to “+000” each time you open the Quick Layer dialog box.

ARP/DRUM

Select Drum Track

You can choose to use the ARP/DRUM from either the Main Combination or Layer Program.

When the “Main” button is turned on, the ARP/DRUM settings of the main Combination will be copied.

When the “Layer” button is turned on, the ARP/DRUM settings of the Layer Program will be copied.

By default, the ARP/DRUM settings of the main Combination will be copied. When the ARP and DRUM buttons are turned on, notes can be played using the arpeggiator, drum track or step sequencer.

Note: You cannot play the arpeggiator, drum track or step sequencers of both the main Combination and the Layer Program at the same time.

 The message “> Caution” is shown if there are not enough insert effect slots or Combination timbres. Touch this to open the Quick Layer/Split Caution message, and check which items are insufficient. For more information, see “Caution messages” on page 384.

Volume **[-127...000...+127]**

Adjusts the volume of the drum track program. The default value is equal to the “Drum Track Volume” of the program in question selected in “Select ARP/DRUM”.

Note: The volume will be adjusted in the same way as that of the main Combination. Values from 0 to -127 lower the volume, and values from 0 to +127 raise the volume.

If there is only one timbre in that drum track that is sounding, this directly adjusts the value of the timbre volume. If there is more than one timbre in the drum track that is sounding, this adjusts the overall volume while maintaining the volume balance between timbres. For this reason, the value will be reset to “+000” each time you open the Quick Layer dialog box.

Tempo **[040.00...300.00]**

This sets the tempo for Arpeggiator, the drum track, and Step Sequencer tempo-related features.

By default, this will be the tempo of the Combination or Program whose ARP/DRUM is selected; you can then change it as desired.

Write Layered Combi

When you’ve created a layer sound that you like, press the **Write Layered Combi** button to save it as a combination. The Write Combination dialog box will appear. For more information, see “Write Combination” on page 433.

After the Write is complete, the system enters COMBINATION mode with the newly created Combination selected.

Cancel

If you press the Cancel button the Quick Layer dialog box closes, and the settings are canceled.

Quick Split

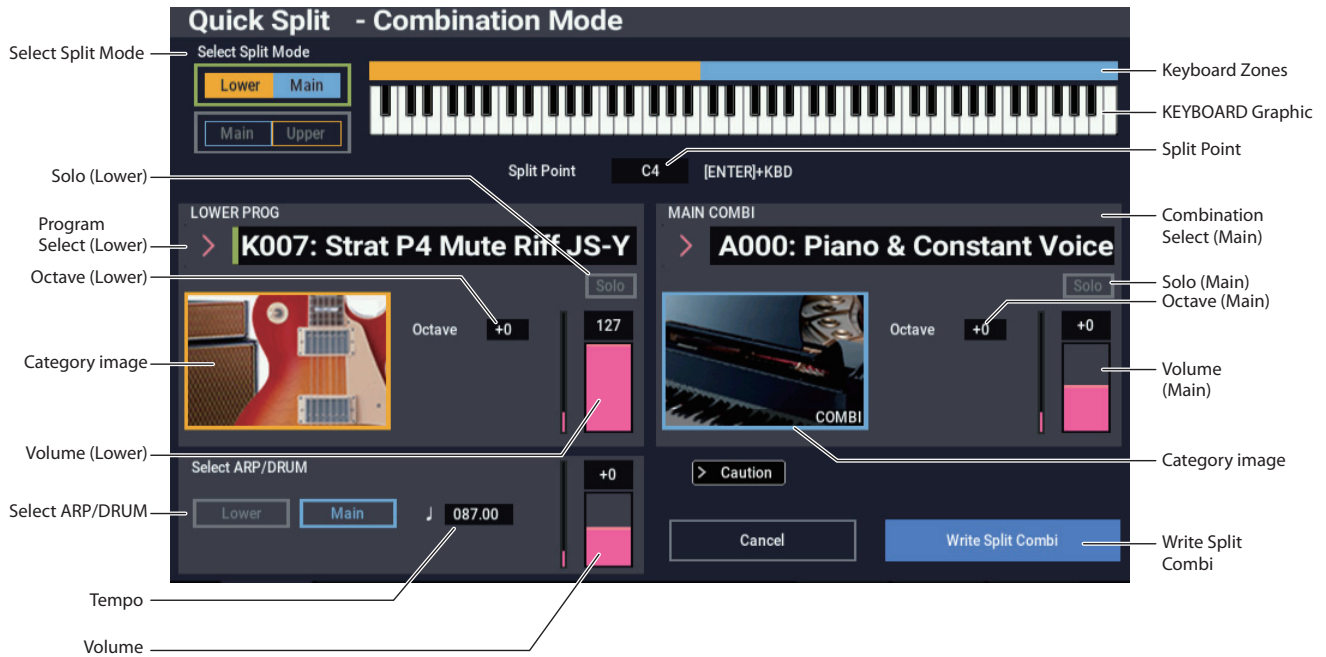

Overview

This dialog box is reached by pressing the Quick Split button on the COMBINATION > Home page.

A “split” means that one sound plays on the lower, left-hand side of the keyboard, and a different sound plays on the upper, right-hand side. The note at which one sound ends and the other begins is called the “split point.”

When invoked from COMBINATION mode, Quick Split lets you split a Program with the selected Combination.

All of the Quick Split controls are non-destructive and reflected immediately when playing on the keyboard. You can experiment with different settings, and fine-tune until you find the perfect sound. Once you’re happy with the results, you can save the split as a new Combination.

Limitations

Depending on the specific sounds that you’re using, the sounds may change slightly when combined using Quick Split. For more information, see “Limitations of Quick Layer/Split in COMBINATION mode,” on page 384.

Split Point & Keyboard Zone Slopes

When the split points of the main Combination and split program fall within the range of the main Combination’s keyboard zone slope, the “Top Slope” and “Bottom Slope” values will be automatically adjusted to their optimum values as much as possible. In this situation, the sounds might not be the same.

Arpeggiator - Timbre Zone Bypass

The value of “Timbre Zone Bypass” for the arpeggiator will be automatically adjusted if possible; and the sounds might not be the same.

Split Controls & Keyboard Graphic

Select Split Mode [Lower / Main, Main / Upper]

This controls whether the Split Program is placed on the upper or lower part of the keyboard.

Lower / Main assigns the Split Program to the left-hand (lower) side of the keyboard—useful for bass sounds, for instance. This is the default.

Main / Upper assigns the Split Program to the right-hand (upper) side of the keyboard, and the Main Combination to the left-hand (lower) side.

Note: When using Quick Split, the damper pedal is set to be enabled for the main Combination but disabled for the lower (upper) Program.

Keyboard Zones

Range in which the lower (upper) Program sounds: yellow

Range in which the main Combination sounds: light blue

Keyboard graphic

The keyboard graphic shows notes as they are played on the physical keyboard.

Split Point [C-1...G9]

This sets the dividing point on the keyboard between the upper and lower sounds.

The value specifies the lowest key for the upper split range (on an organ, this means the upper keyboard). The default setting is C4.

Note: You can use the keyboard or the keyboard graphic display to input this value. Press the ENTER button, and then press a key or input the note number using the keyboard graphic display.

LOWER or UPPER PROG

Lower Program (Upper Program)

Select the programs to add to the lower or upper side.

Use the “Bank/Program Select” and “Category/Program Select” to search for banks, categories and keywords.

Note: This automatically searches for timbres not used by the main Combination to set the lower (upper) Programs. Note that if the main Combination does not use all 16 timbres, timbre 16 is set as the lower (upper) Program. For this reason, the main Combination will not sound exactly the same.

Note: Selecting the lower (upper) Program will automatically copy the lower (upper) Program’s insert effects. In the same way, the “Send1” and “Send2” values will be copied to the master effect. However, the values will not be copied if there are not enough insert effects available.

Note: For the master and total effects, the main Combination settings are copied. Because of this, the lower (upper) Program will not sound the same in PROGRAM mode.

 The message “> Caution” is shown if there are not enough insert effect slots or Combination timbres. Touch this to open the Quick Layer/Split Caution message, and check which items are insufficient. For more information, see “Caution messages” on page 384.

Solo [On, Off]

This turns the Solo function on/off. If Solo is enabled, only tracks with Solo On will sound; other tracks will be muted.

The setting will alternate on/off each time you press the Solo button.

Category image

This display-only graphic represents the category or sub-category of the Split Program.

Octave [-2, -1, 0, +1, +2]

This adjusts the pitch of the Split Program in 1-octave units.

Internally, the **Octave** setting controls the Timbre’s **Transpose** parameter.

Volume [000...127]

This adjusts the volume of the Split Program, directly controlling the Timbre’s volume slider. The default setting is 127.

MAIN COMBI

(Combination select) [List of Combinations]

By default, this will be the currently selected Combination. You can also select a different Combination, if desired. You can use all of the normal Combination selection methods, including bank and number, category, and Find.

Solo [On, Off]

This turns the Solo function on/off. If Solo is enabled, only tracks with Solo On will sound; other tracks will be muted.

The setting will alternate on/off each time you press the Solo button.

Category image

This display-only graphic represents the category or sub-category of the Main Combination.

Octave [-2, -1, 0, +1, +2]

This sets the pitch of the Main Combination in 1-octave units.

Internally, this edits all of the individual Timbre **Transpose** parameters.

Volume [-127...000...+127]

This adjusts the overall volume of the original Combination while maintaining the balance between individual Timbres. Internally, it does so by controlling the Timbre Volume sliders. In order to maintain the original balance, the editing range when increasing volume is automatically restricted; once any of the Timbres reaches its maximum volume setting, the overall volume will not rise any further.

Since this is a relative adjustment, the parameter will always start at the default of 000 (no change).

+001...-127 lowers the volume, and +001...+127 raises the volume.

Note: The values from 0 to +127 will raise the volume until one of the timbre volumes reaches its maximum. When one of the timbres reaches its maximum volume, the volume will not go up any more.

Note: The volume can be set for each timbre in a Combination. This parameter is used to adjust the overall volume while maintaining the volume balance between timbres. For this reason, the value will be reset to “+000” each time you open the Quick Layer dialog box.

ARP/DRUM

Select ARP/DRUM

This selects whether to use the ARP/DRUM settings from the main Combination or from the lower (upper) Program.

When the “Main” button is turned on, the ARP/DRUM settings of the main Combination will be copied.

When the “Lower (Upper)” button is turned on, the ARP/DRUM settings of the lower (upper) Program will be copied.

By default, the ARP/DRUM settings of the main Combination will be copied. When the ARP and DRUM buttons are turned on, notes can be played using the arpeggiator, drum track or step sequencer.

Note: You cannot play the arpeggiator, drum track or step sequencers of both the main Combination and the lower (upper) Program at the same time.

 The message “> Caution” is shown if there are not enough insert effect slots or Combination timbres. Touch this to open the Quick Layer/Split Caution message, and check which items are insufficient. For more information, see “Caution messages” on page 384.

Volume [-127...000...+127]

This adjusts the volume of the ARP/DRUM. Since this is a relative adjustment, the parameter will always start at the default of 000, which maintains the Drum Track’s original volume.

Note: The volume will be adjusted in the same way as that of the main Combination. +001...-127 lowers the volume, and +001...+127 raises the volume.

If there is only one timbre in that drum track that is sounding, this directly adjusts the value of the timbre volume. If there is more than one timbre in the drum track that is sounding, this adjusts the overall volume while maintaining the volume balance between timbres. For this reason, the value will be reset to “+000” each time you open the Quick Split dialog box.

Tempo [040.00...300.00]

This sets the tempo for Arpeggiator, the drum track, and other tempo-related features.

By default, this will be the tempo of the Combination or Program whose ARP/DRUM is selected; you can then change it as desired.

Write Splitted Combi

When you've created a split sound that you like, press the **Write Splitted Combi** button to save it as a combination.

The Write Combination dialog box will appear. For more information, see “Write Combination” on page 433.

After the Write is complete, the system enters COMBINATION mode with the newly created Combination selected.

Cancel

If you press the Cancel button the Quick Split dialog box closes, and the settings are canceled.

0-2: Performance Meters

This page lets you look at the real-time performance of the NAUTILUS, including voice usage, voice stealing, and effects.

For more information, see “0-2: Performance Meter” on page 13.

✓ 0-2: Page Menu Commands

- Compare →p.112
- Write Combination →p.433
- Exclusive Solo →p.113
- Copy From Program →p.433
- Add To Set List →p.113
- Load required samples →p.114
- Edit Program →p.434
- Initialize Combination →p.435
- PAGE →p.126
- MODE →p.126

0-6: ARP DRUM

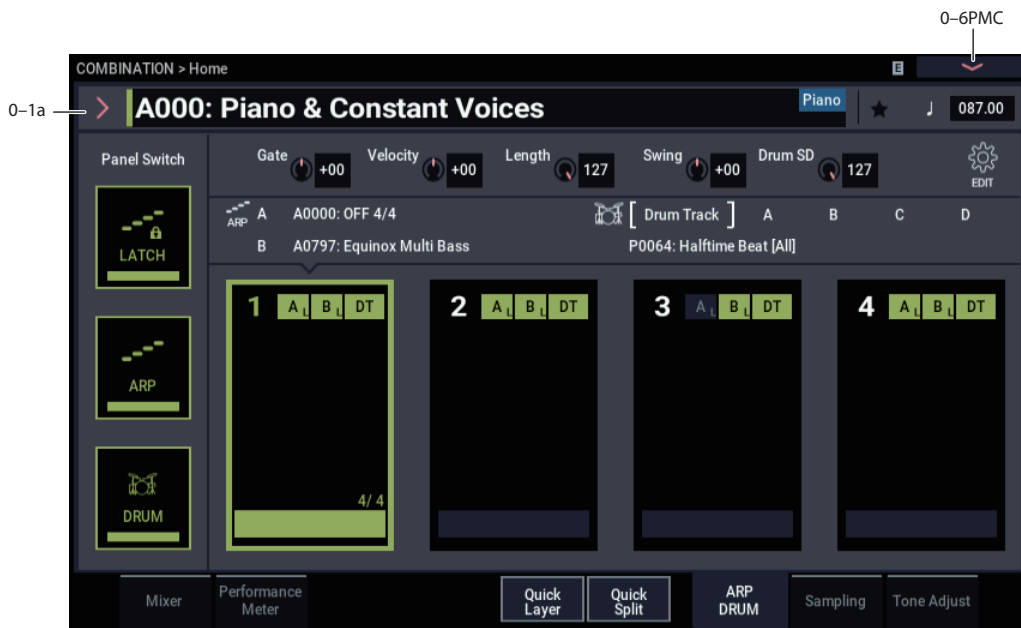

These settings are for the arpeggiator function in Combination mode. You can use two arpeggiators (A and B) and a drum track or step sequencer in COMBINATION mode.

Here we will configure the arpeggiator and drum track/step sequencer for each of the four scenes.

You can select a scene and then change the settings of the arpeggiator and drum track/step sequencer together. Refer to PROGRAM mode for the respective settings.

For more information, see “0-6: ARP DRUM” on page 15.

Scene Common Setup

Drum MIDI Ch. [01...16, Gch]

This sets the MIDI channel used to transmit MIDI data from the drum track or step sequencer.

The drum track or step sequencer will play using the Program of the timbre that is set to the same MIDI channel.

Gch: Outputs to the channel that is set as the global MIDI channel in “MIDI Channel” (GLOBAL 1-1a).

The “Status” setting of the timbre for the MIDI channel that matches the “Output” determines whether the pattern data is transmitted to an external device.

Scene Cue Mode

Select either Immediately or Measure for the timing to be used when you change scenes while they are playing.

Immediately: The scene will be changed right away once a new scene is selected.

Measure: After the new scene is selected, the scene will be changed upon moving to the next measure in the scene, or when the scene returns to the beginning.

Note: The length of a scene or its measures is determined by the arpeggiator or drum track/step sequencer settings in that scene. When the drum function is off, the scene length will

be the length of the selected drum track or step sequencer. When the drum function is off, the length of the scene is used for the length of the arpeggiator.

Note: When the drum function is off and the arpeggiator pattern is set to the preset pattern, the Immediately setting will be used, since it does not have a length parameter.

More

Open the Scene Common Setup detailed settings dialog box.

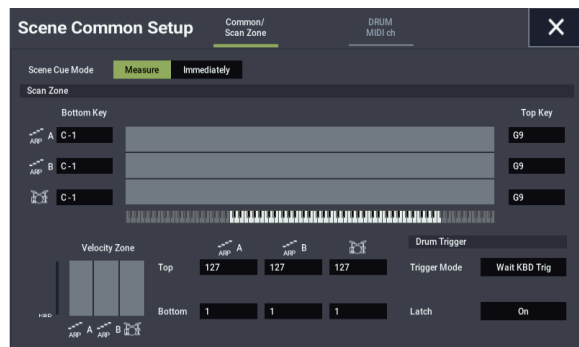

Common/Scan Zone:

Configures the respective settings for arpeggiators A and B. For more on the various parameters, refer to PROGRAM mode. For more information, see “Common/Scan Zone :” on page 16.

DRUM MIDI ch:

| Scene Common Setup | | Common/Scan Zone | | DRUM MIDI ch | | | |
|--------------------|------------------------|------------------|-----|--------------|-----|---------|-----|
| Output Ch | 10 | | | | | | |
| Timbre 1 | Bright Italian Grand | MIDI Ch | Gch | Bottom Key | C-1 | Top Key | G9 |
| Timbre 2 | Gch Voices L&R | MIDI Ch | Gch | Bottom Key | C-1 | Top Key | G2 |
| Timbre 3 | Gch Voices L&R | MIDI Ch | Gch | Bottom Key | G#2 | Top Key | G4 |
| Timbre 4 | Gch Voices L&R | MIDI Ch | Gch | Bottom Key | G#4 | Top Key | G6 |
| Timbre 5 | Gch Voices L&R | MIDI Ch | Gch | Bottom Key | G#6 | Top Key | G9 |
| Timbre 6 | Deep Energy Bass | MIDI Ch | 04 | Bottom Key | C-1 | Top Key | G9 |
| Timbre 7 | Padme & Leadme | MIDI Ch | 05 | Bottom Key | C-1 | Top Key | G9 |
| Timbre 8 | Gliding Squares | MIDI Ch | 06 | Bottom Key | C4 | Top Key | G9 |
| Timbre 9 | 08 Four Voice Brass | MIDI Ch | 07 | Bottom Key | C-1 | Top Key | G9 |
| Timbre 10 | Singing Strings | MIDI Ch | 07 | Bottom Key | C-1 | Top Key | G9 |
| Timbre 11 | Evil Dark Kit | MIDI Ch | 10 | Bottom Key | F2 | Top Key | A#2 |
| Timbre 12 | Acoustic Pop Kit | MIDI Ch | 10 | Bottom Key | F#0 | Top Key | A2 |
| Timbre 13 | Acoustic Pop Kit | MIDI Ch | 10 | Bottom Key | B2 | Top Key | C#5 |
| Timbre 14 | Evil Dark Kit | MIDI Ch | 10 | Bottom Key | G1 | Top Key | D#3 |
| Timbre 15 | Nautilus Grand Dry/Amb | MIDI Ch | Gch | Bottom Key | C-1 | Top Key | G9 |
| Timbre 16 | Nautilus Grand Dry/Amb | MIDI Ch | Gch | Bottom Key | C-1 | Top Key | G9 |

Output Ch [01...16, Gch]

This displays the MIDI channel used to transmit MIDI data for the drum patterns set in each timbre.

The drum patterns play using the Program of the timbre that is set to the same MIDI channel.

Scene1-4 Setup

Here we configure each of the arpeggiator and drum settings for each scene.

There are two arpeggiators (A and B) in COMBINATION mode, and two arpeggio patterns can be used simultaneously.

Arpeggio Pattern [P0...P4, A0000...A2047, B000...B127]**Loop/1Shot****Latch****Drum Track/StepSeq select****Drum Track Pattern****More**

Refer to PROGRAM mode for the respective settings. For more information, see “Scene1-4 Setup” on page 18.

Output Ch [01...16, Gch]

Sets the MIDI output channel for each arpeggiator.

Out of the MIDI data transmitted from each arpeggiator, the timbres that match the MIDI channels you set here will sound.

Gch: The MIDI output channel will be the global MIDI channel (GLOBAL 1-1a: “MIDI Channel”) for each arpeggiator.

Thru By ARP Switch Off [On, Off]

This sets whether the MIDI data received by each arpeggiator will be transmitted (sent through) to the timbre via the MIDI channel specified in “Output Ch”, when the arpeggiator function is off.

On (checked): When the arpeggiator function is off, the MIDI data received by each arpeggiator will be transmitted (sent through) to the timbre via the MIDI channel specified in “Output Ch”.

Off (unchecked): When the arpeggiator function is off, the MIDI data received by each arpeggiator will not be transmitted to the timbre.

Timbre Zone Bypass [Off, On]

Sets whether to enable the key zone settings (→p.16 “Scan Zone”) and velocity zone settings (→p.16 “VelocityZone”) of the timbres, for the phrases and patterns of each arpeggiator.

On (checked): Bypasses the timbre key zone and velocity zone settings for the phrases and patterns that are generated. The various timbre settings will be ignored, and all generated notes will sound.

Off (unchecked): Enables the timbre key zone and velocity zone settings for the phrases and patterns that are generated. Any notes generated that fall outside of the timbre’s key zone or velocity zone will not sound.

Edit STEP SEQUENCE

For more information, see “Edit STEP SEQUENCE” on page 20.

✓ 0-6: Page Menu Commands

- Compare →p.112
- Write Combination →p.433
- Exclusive Solo →p.113
- Copy From Program →p.433
- Add To Set List →p.113
- Copy External Scene →p.122
- Copy Scene →p.122
- Swap Scene →p.122
- Initialize Scene →p.122
- PAGE →p.126
- MODE →p.126

0–8: Sampling

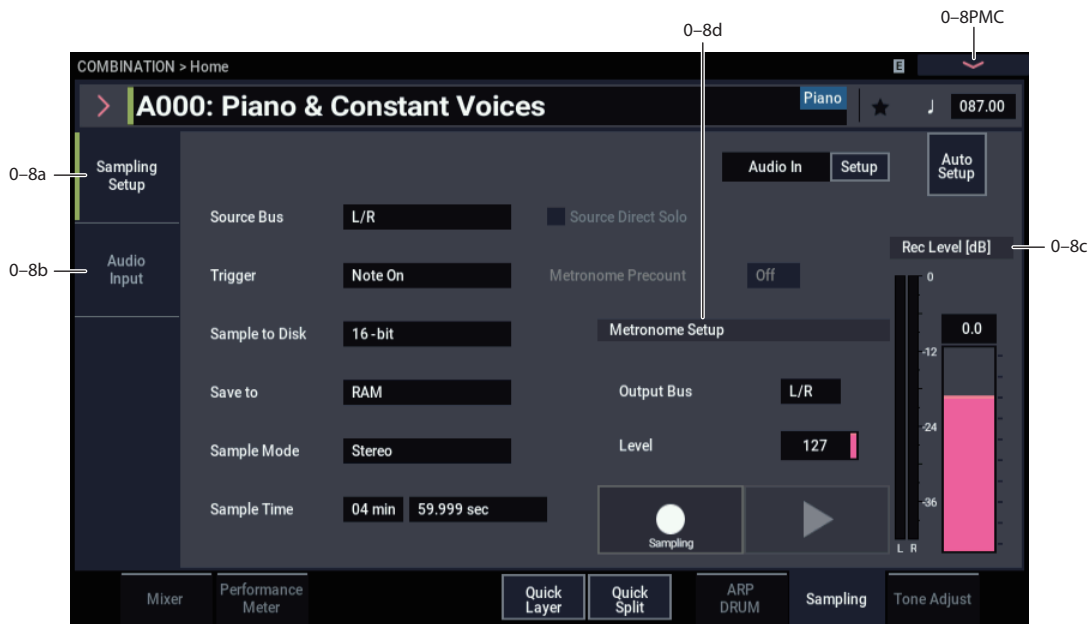

This page lets you adjust the settings for the analog and digital audio inputs, and the sampling-related settings for COMBINATION mode.

You can sample incoming audio signals or resample internal NAUTILUS sounds, including ARP and real-time performances. The NAUTILUS can also be used as a 4-in, 6-out effect processor.

For example, you can:

- Play an guitar through an audio input, while listening to a Arpeggiator phrase—and sample only the guitar input, without any of the Arpeggiator sounds.
- Play a guitar as above, but sample both the guitar and the Arpeggiator phrase together.
- Sample yourself while playing NAUTILUS sounds in real-time, including controller movements, ARP, effects, etc.

0–8a: Sampling Setup

Here you can select the source to be sampled, and the method by which to initiate sampling.

Source Bus [Audio Input1/2, USB 1/2, REC1/2...3/4, Indiv.1/2...3/4]

Source Direct Solo [Off, On]

Trigger [Sampling START button, Note On]

Metronome Precount [Off, 4, 8, 3, 6]

Sample to Disk [16-bit, 24-bit]

This sets the bit depth for sampling to drive. For more information, please see “Sample to Disk” on page 24.

Save to [RAM, Disk]

Sample Mode [L-Mono, R-Mono, Stereo]

Sample Time [min] [sec]

These parameters are the same as in PROGRAM > Home–Sampling page. For more information, please see “0–8a: Sampling Setup” on page 22.

The **Sampling Setup** settings apply to all of COMBINATION mode, and are not saved with individual Combinations.

0–8b: Audio Input

These parameters control the level, pan, play/mute and solo status, send levels, and bus assignments for each of the analog and digital inputs. For more information, see “0–8b: Audio Input” on page 26.

Use Global setting [Off, On]

Each Combination can either use the single, Global audio input mixer setup, or have its own custom settings. For more information, see “Use Global setting” on page 26.

Input 1 & 2

These are settings for the analog inputs.

USB 1 & 2

These are settings for the USB inputs. The parameters are the same as for “Input 1 & 2” above.

| | |
|-------------------------------------|--|
| Bus Select (IFX/Indiv.) | [L/R, IFX1...12, 1...4, 1/2...3/4, Off] |
| FX Ctrl Bus (FX Control Bus) | [Off, 1, 2] |
| REC Bus | [Off, 1...4, 1/2, 3/4] |
| Send1 (to MFX1) | [000...127] |
| Send2 (to MFX2) | [000...127] |
| PLAY/MUTE | [Off, On] |
| Solo ON/OFF | [Off, On] |
| Pan | [L000...C064...R127] |
| Level | [000...127] |

0-8c: Rec Level [dB]

These parameters are the same as in PROGRAM > Home–Sampling– Audio Input. For more information, please see “Recording Level” on page 27.

Recording Level [-Inf, -72.0 ... +0.0 ... +18.0]

The **Recording Level** setting applies to all of COMBINATION mode, and is not saved with individual Combis.

0-8d: Metronome Setup

Here you can specify the output destination and volume of the metronome sound that is heard when you begin sampling. The metronome is valid only if **Trigger** is set to Sampling START button.

Output Bus [L/R, L, R, 1...4]

Level [000...127]

These parameters are the same as in PROGRAM > Home–Sampling page. For more information, please see “0-8d: Metronome Setup” on page 393.

0-8: Page Menu Commands

- Compare →p.112
- Write Combination →p.433
- Exclusive Solo →p.113
- Copy From Program →p.433
- Optimize RAM →p.114
- Select Sample No. →p.115
- Auto Sampling Setup →p.116
- Add To Set List →p.113
- PAGE →p.126
- MODE →p.126

0-9: Tone Adjust

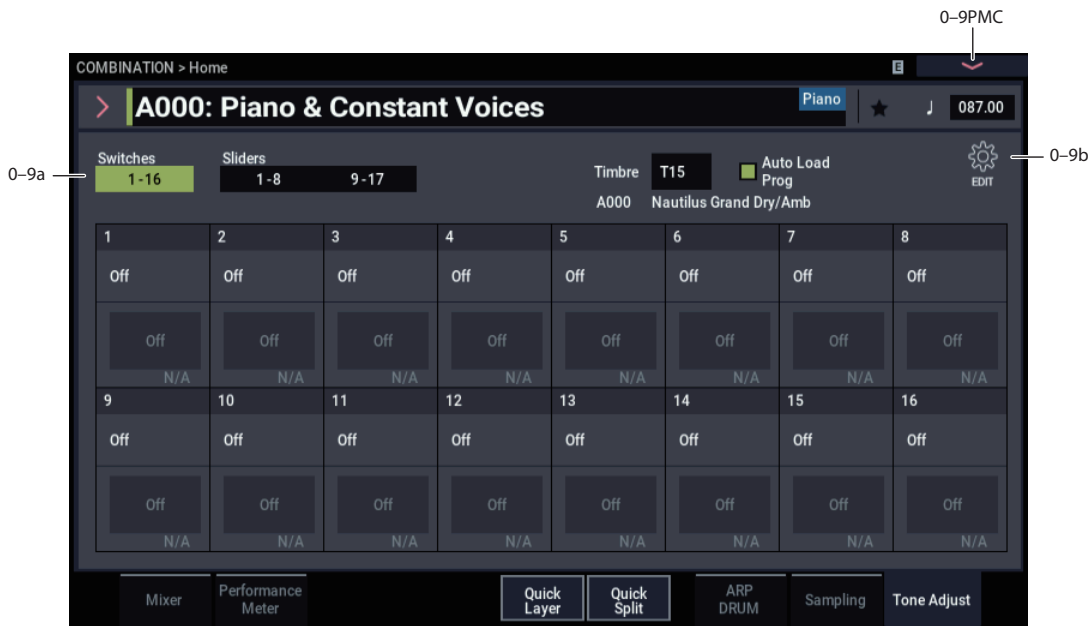

0-9a: Tone Adjust

Tone Adjust provides two important features simultaneously:

- It lets you use all of the sliders, and switches to control Program parameters - like the knobs on an analog synth, or the drawbars on an organ.
- It lets you modify Programs for use within a specific Combi, including everything from subtle tweaks (like changing LFO speeds) to dramatic changes (such as selecting a different Multisample). Any changes that you make are stored with the Combi, and do not alter the original Program.

Each of the sixteen Timbres has its own set of tone adjust parameters, but only one Timbre is shown at a time.

For more information, see:

- “Tone Adjust and MIDI SysEx” on page 30
- “Interaction between Tone Adjust and MIDI CCs” on page 30
- “Absolute, Relative, and Meta parameters” on page 30

Saving Tone Adjust Edits

In PROGRAM mode, when you make edits via Tone Adjust and then save the results, the Program data is changed—just as if you’d edited the internal parameters directly. For more information, see “Saving Tone Adjust Edits” on page 29.

In COMBINATION mode, however, all Tone Adjust edits are stored within the Combi; the Program itself is not changed. This lets you alter the way that a Program sounds in one specific Combi without affecting the way that it sounds in PROGRAM mode, or in any other Combis or Songs.

Switches 1-16 button

Switches to the Switch page of Tone Adjust.

Sliders 1-8, 9-17 buttons

Switches to the Slider page of Tone Adjust.

Timbre select

Timbre

[1...16]

This selects the Timbre whose Tone Adjust parameters appear on the screen. You can switch back and forth between the different Timbres as much as you like, without losing your edits.

Auto Load Prog

[Off, On]

When you first load a Program into a Timbre, this parameter determines whether or not the Program’s Tone Adjust settings will be loaded as well.

These settings include the parameters assigned to each slider, and switch, along with the on/off state of any Switches assigned to Absolute parameters.

Note that any edits you’ve made using Tone Adjust in PROGRAM mode will already have been stored into the Program’s parameters. This means that the Program will still sound the same, whether or not you load the Tone Adjust settings.

Once the Program has been loaded, you can change any or all of the Tone Adjust settings as desired, including both assignments and values. All such edits are stored in the Combi, without affecting the original Program.

If **Auto Load PRG** is **On**, Tone Adjust settings will be automatically loaded along with the Program.

If **Auto Load PRG** is **Off**, then the relationship between the types of the old and new Programs will determine what happens, as shown in the table below:

| If the old Program is... | And the new Program is... | Then Tone Adjust parameters and values are... |
|--------------------------|---|---|
| An HD-1 Program | An HD-1 Program | kept the same |
| A HD-1 Program | An EXi Program | loaded from the new Program |
| Any EXi Program | A HD-1 Program | loaded from the new Program |
| An EXi Program | An EXi Program with the same EXi assigned to the same slots as the previous Program | kept the same |
| An EXi Program | An EXi Program which does not use the same EXi as the previous Program | loaded from the new Program |

0-9b: Tone Adjust Edit

Press the  (EDIT) icon to edit the assignments and other settings for the Tone Adjust function.

Sliders 1-8, 9-17

Assign [List of Tone Adjust assignments]

This lets you assign a Tone Adjust parameter to the slider.

The first group of parameters are the Common set, which are supported by most Program types. For a full list, see “Common Tone Adjust Parameters” on page 31.

After the Common parameters, the items in the list will vary depending on the Program type. For more information, please see:

“HD-1 Tone Adjust Parameters,” on page 32.

“AL-1: Tone Adjust,” on page 180.

“CX-3: Tone Adjust,” on page 203.

“STR-1: Tone Adjust” on page 251.

“MS-20EX Tone Adjust parameters” on page 280

“PolysixEX Tone Adjust parameters” on page 295.

Other EXi instruments will have their own set of parameters, as described in their manuals.

Assignments are exclusive

Each controller can be assigned to only one parameter, and each parameter can be assigned to only one controller.

To swap a parameter from one control to another, you’ll need to first un-assign it from the old control, and then assign it to the new control.

Value [Depends on parameter]

This shows the current value of the parameter. The range of values will vary depending on the parameter assigned to the slider.

Switches 1-16

Tone Adjust switches act a little differently than sliders.

When a switch is assigned to a **Relative** parameter, or an **Absolute** parameter with more than two states:

Switch On = **On Value** (see below)

Switch Off = the Program’s stored value

When a switch is assigned to a two-state **Absolute** parameter, such as **Hold**, the switch status directly reflects the parameter value:

Switch On = **On**

Switch Off = **Off**

Assign [List of Tone Adjust assignments]

This lets you assign a Tone Adjust parameter to the switch. For more information, see “Assign,” above.

On Value [Depends on parameter]

The parameter is set to this value when the switch is On.

When the switch is assigned to a two-state **Absolute** parameter, such as **Hold**, this will always be the same as the **Switch Status** (see below).

Switch Status [Off, On]

This simply shows whether the switch is On or Off. The status is also shown by the LEDs in the physical buttons.

✓ 0-9: Page Menu Commands

- Compare →p.112
- Write Combination →p.433
- Exclusive Solo →p.113
- Copy From Program →p.433
- Add To Set List →p.113
- Copy Tone Adjust →p.436
- Reset Tone Adjust →p.436
- PAGE →p.126
- MODE →p.126

COMBINATION > EQ/X-Y/Controllers

1-1: Timbre EQ



Each Timbre has a dedicated three-band EQ, with sweepable mid band. This page lets you view and adjust the settings for all 16 Timbres at once.

1-1a: Combination Name

Bank [A...N]

Combination Name [000...127: Name]

Tempo [040.00...300.00, EXT]

These parameters set the displays of the Combination information that is being edited and the Combination bank/number/name, as well as the tempo used to control the arpeggiator and other features.

1-1b: 3 Band Parametric EQ

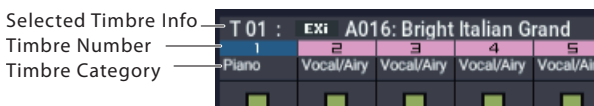

Selected Timbre Info

This area displays information about the timbre selected for editing – T: timbre number/program bank/number/name, Ch: MIDI channel number.

Timbre Number

This indicates the timbre number. The various parameters below each timbre number make settings for the corresponding timbre.

The background color changes according to the timbre’s category and status.

Timbre Category

This shows the abbreviated category name of the Program assigned to the Timbre.

Timbre 01 (Timbre Number)

Auto Load Prog EQ [Off, On]

When you first load a Program into a Timbre, this parameter determines whether or not the Program’s EQ settings will be loaded as well.

Once the Program has been loaded, you can change any or all of the EQ settings as desired. All such edits are stored in the Combination, without affecting the original Program.

Regardless of this setting, subsequent edits to the Program’s EQ in PROGRAM mode will not affect the Combination.

On: the Program’s EQ settings will be loaded automatically along with the Program. This is the default setting.

Off: the Program’s EQ settings won’t be loaded. Use this if you’ve set up the EQ in a specific way, and then want it to stay unchanged while you try out different Programs.

Bypass [On, Off]

If this is **On (checked)**, all of the EQ will be disabled, including “Input Trim.” Bypass can be convenient for comparing the results of the EQ with the original signal.

Input Trim [00...99]

This controls the volume level going into the EQ. Note that this parameter uses a linear scale; 50 is equivalent to –6dB, 25 is the same as –12dB, and so on.

High settings of the Low, Mid, and High Gain controls can cause substantial increases in the overall level. You can compensate for this by turning down the input trim.

The meter to the left of the parameter shows the post-EQ signal level in realtime.

High Gain [-18.0...+00.0...+18.0dB]

This controls the gain of the 10kHz High Shelf EQ, in increments of 0.5dB.

Mid Frequency [100Hz...10kHz]

This sets the center frequency for the Mid sweep EQ.

Mid Gain [-18.0...+00.0...+18.0dB]

This controls the gain of the Mid Sweep EQ, in increments of 0.5dB.

Low Gain [-18.0...+00.0...+18.0dB]

This controls the gain of the 80Hz Low Shelf EQ, in increments of 0.5dB.

Timbre 02... 16 (Timbre Number)

These parameters adjust the three-band EQ (with sweepable mid range) for timbres 2 through 16. They are the same as for timbre 1. See “Timbre 01”.

✓ **1-1: Page Menu Commands**

- Compare →p.112
- Write Combination →p.433
- Exclusive Solo →p.113
- Copy From Program →p.433
- Show EQ Graphic →p.436
- PAGE →p.126
- MODE →p.126

1-5: X-Y Volume

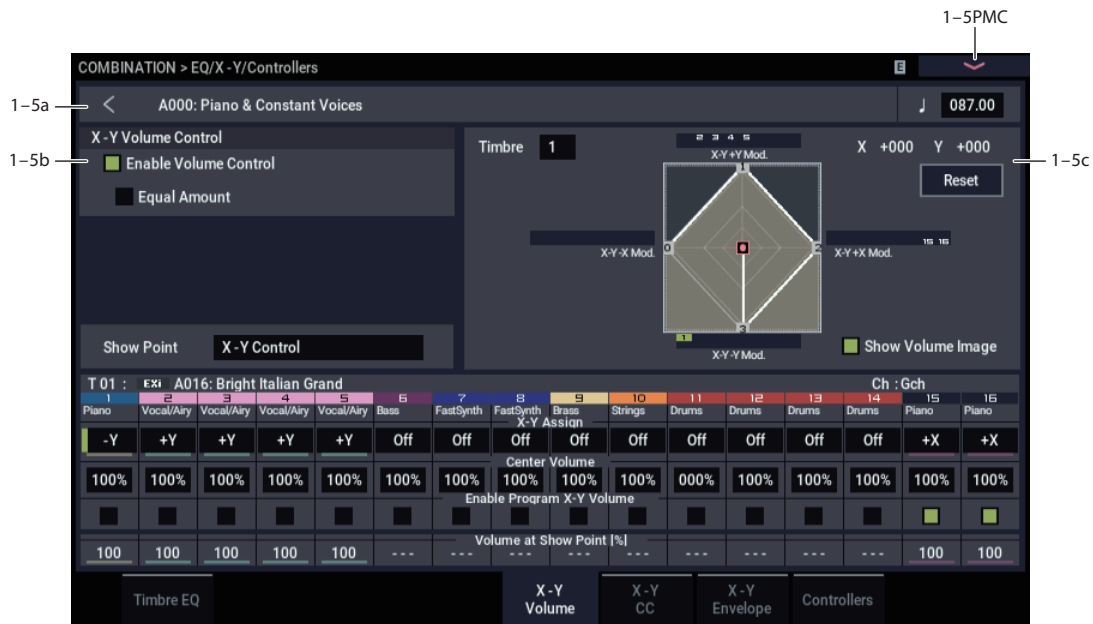

Vector Synthesis lets you control Timbre volumes and Program & Effects parameters by using the programmable X-Y Envelope, or by the combination of the two.

For more background information on Vector Synthesis, please see “What does Vector mean?” on page 41.

Program and Combi Vectors work together

In COMBINATION mode, each Timbre’s Program still has its own X-Y Envelope, which controls volume and CCs as it did in PROGRAM mode. You can disable the Program X-Y Volume and CC control separately for each Timbre, if desired.

There is also a separate Combi-wide X-Y Envelope, with its own X-Y Volume and CC control settings. As with the Program X-Y, you can disable the Combi Volume and CC control separately for each Timbre.

How Combi X-Y Volume works

In PROGRAM mode, X-Y Volume fades between the two Oscillators. Oscillator 1 is always at maximum volume when the X-Y position is all the way to the left (–X), and Oscillator 2 is always at maximum when the X-Y Position is all the way to the right (+X).

In COMBINATION mode, on the other hand, the Vector can fade between any or all of the 16 Timbres. You can assign each of the Timbres to be controlled by any of the four X-Y axes (+X, –X, +Y, –Y), or to not be controlled at all.

This lets you set up complex transitions between different Programs, including between HD-1 and different EXi instruments.

1–5a: Combination Name**Bank** [A...N]**Combination Select** [000...127: Name]**Tempo (.)** [040.00...300.00, EXT]

These parameters set the displays of the Combination information that is being edited and the Combination bank/number/name, as well as the tempo used to control the arpeggiator and other features.

1–5b: X-Y Volume Control

X-Y Volume Control lets you adjust the relative volumes of the 16 Timbres by moving the X-Y control (or the X-Y Envelope) from left to right on the X axis, and up and down on the Y axis.

The **Equal Amount** check-box makes the Vector create a smooth fade between the Timbres, while the individual Timbre **Center Volume** parameters allow you to create more complex fade shapes.

Enable Volume Control [Off, On]

When this box is checked, the X-Y position will control the volumes of all Timbres whose **X-Y Assign** parameter is not set to **Off**.

When this box is not checked, the X-Y position will not directly affect volume. However, it's still possible for the Vector to control volume via X-Y CCs and AMS, depending on the individual Program's parameter settings.

Equal Amount [Off, On]

This applies only when **Enable Volume Control** is **On**.

When **Equal Amount** is **On**, the Vector will fade between all four X-Y axes while maintaining a total amount of 100%. This provides a smooth fade between the different sounds, and is the type of volume control used by classic Vector synths.

Note that this will work best when the Programs assigned to each of the four axes have equivalent volumes. For instance, you might create a Combi with four Programs, each sounding at the same volume and assigned to a different axis. You could then add a fifth Program, assign it to one of the axes, and then use the Timbre volume sliders to reduce the levels of both Programs on that axis by 50%—so that their combined volume is the same as any one of the other Programs.

Also, when this is checked, the **Center Volume** parameters will be grayed out, since **Equal Amount** sets them automatically.

When **Equal Amount** is **Off**, the individual Timbre **Center Volume** parameters determine the way in which X-Y position affects volume.

Note: For an interesting variation on this effect, turn **Equal Amount Off**, and instead set all of the Timbre **Center Volumes** to **50%**. The Timbres will still fade together smoothly, but with a more gentle effect towards the extremes of the X-Y axes.

1–5c: X-Y Graphic**X-Y Graphic**

This shows a diagram of the X-Y space, including the five points of the X-Y Envelope (labeled 0–4).

The transitions between the EG's points are shown by black lines, and the loop transition is shown by a gray line.

Touch this area to control the vector by moving the X-Y point.

Show Volume Image [Off, On]

The X-Y graphic includes an image representing the X-Y Volume Control settings for the current Timbre (see **Timbre Select**, below). You can use the **Show Volume Image** check-box to toggle this part of the graphic on and off.

Timbre Select [01...16]

This selects the Timbre whose volume image will be shown.

Show Point [X-Y Control, X-Y Envelope Point 0...4]

You can view the volume and CC values for any of the EG's five points. This selects the point whose values will be shown.

Timbre Volume & CC Display

This read-only display shows the volume and CC values for the current X-Y point, as selected by the Show Point parameter, above.

Vector Synthesis system, Combi mode

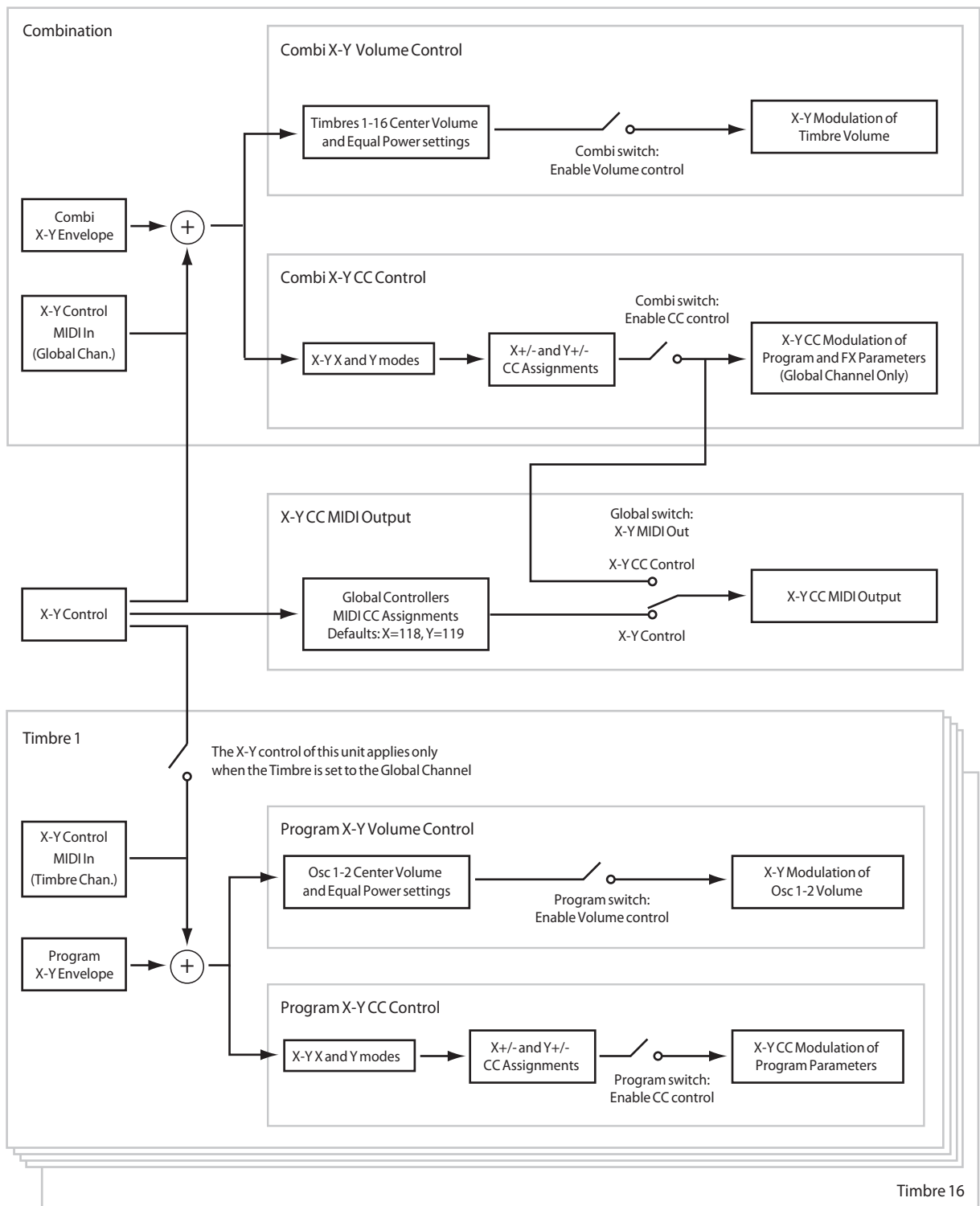

Timbre 01

X-Y Assign [Off, +X, -X, +Y, -Y]

This assigns an axis of the Vector to control the Timbre's volume. See the diagram "X-Y Assign and Program Volume," below, for more details.

Off means that the X-Y position will not affect the Timbre's volume.

X-Y Assign and Program Volume

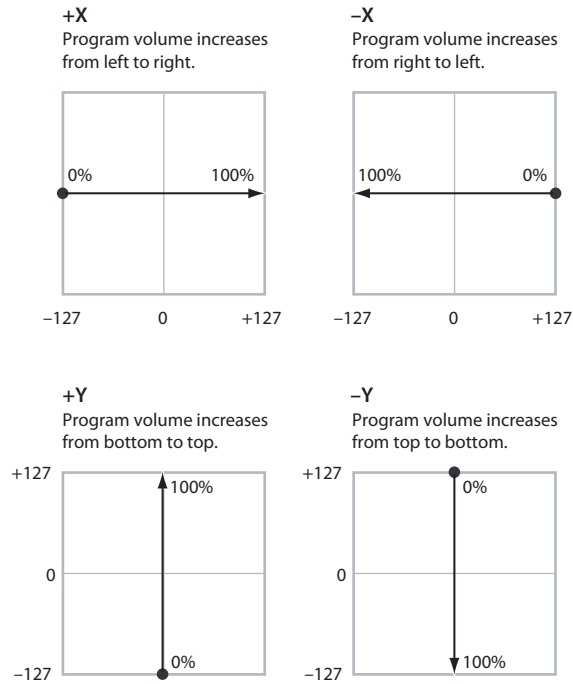

Center Volume [0, 25, 50, 75, 100%]

This sets the volume of Timbre 1 at the center point. It applies only when **Equal Amount**, above, is set to **Off**.

The volumes at the extreme ends of the axis are fixed, depending on the setting of the **X-Y Assign** parameter.

For instance, if **X-Y Assign** is set to **-X**, the Timbre will always be at 100% volume on the left side, and 0% (silent) on the right side.

This parameter applies only to the Combi X-Y Volume control, and does not change the Program's individual X-Y Volume settings.

Timbre Center Volume, X-Y Assign = -X

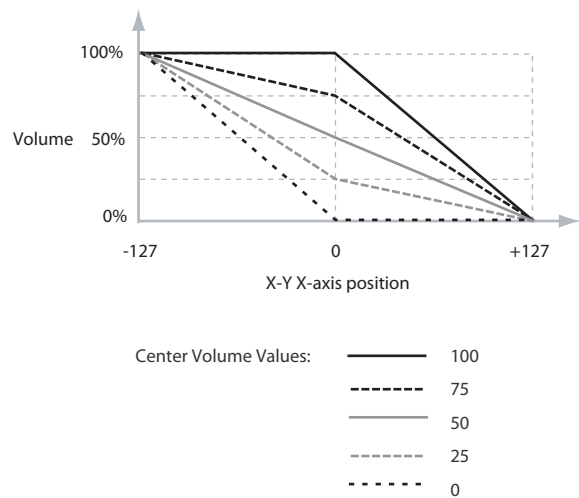

Enable Program X-Y Volume [Off, On]

When this is turned **On**, the Program's X-Y Volume control will function as it does in PROGRAM mode, crossfading between Oscillators 1 and 2. The crossfade will be controlled by the Program's X-Y Envelope and is not affected by the Combi's X-Y Envelope.

When this is turned **Off**, the Program's X-Y Volume control will be disabled.

Volume at Show Point [%]

Shows the volume at the current X-Y point selected in "Show Point".

Timbres 02-16

The parameters for Timbres 2-16 are identical to those for Timbre 01, as described above.

✓ 1-5: Page Menu Commands

- Compare →p.112
- Write Combination →p.433
- Exclusive Solo →p.113
- Copy From Program →p.433
- PAGE →p.126
- MODE →p.126

1-6: X-Y CC

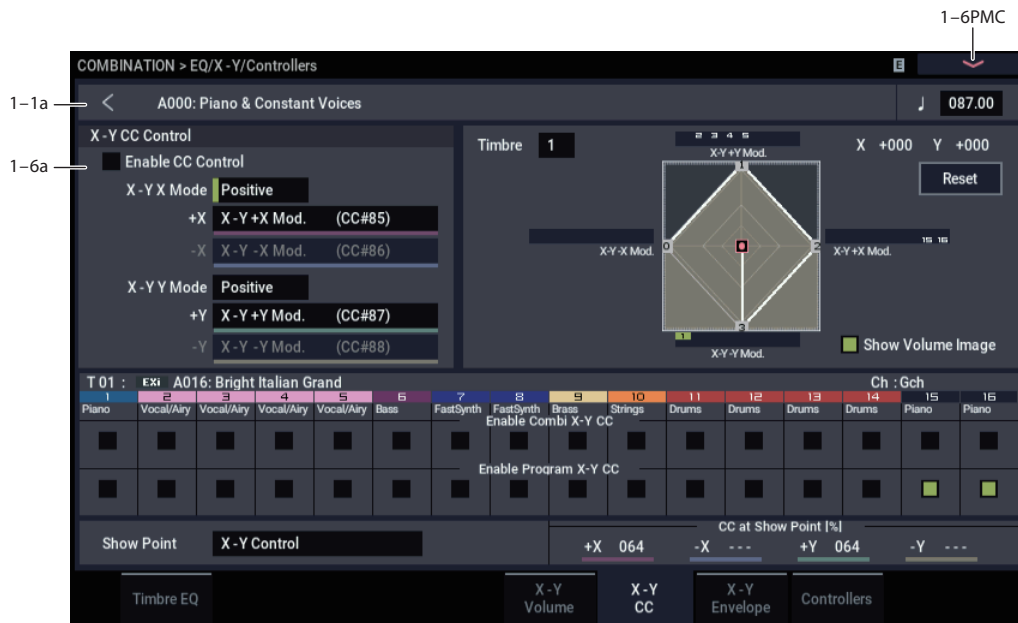

1-6a: X-Y CC Control

X-Y CC Control lets you use the X-Y Envelope to control the Combi's Effects.

Each of the four directions of the Vector can send a different MIDI CC, including left (-X), right (+X), up (+Y), and down (-Y). You can choose between several different patterns combining these four directions by using the X-Y X Mode and X-Y Y Mode parameters.

The X-Y CCs are also sent to all Global Channel Timbres. These may modulate Program parameters, like any other MIDI CCs, depending on the settings within each individual Program.

Finally, you can optionally send these CCs out to external MIDI instruments. A global parameter's X-Y MIDI Out allows you to enable or disable this MIDI output; by default, it is disabled.

Program and Combi Vectors work together

In COMBINATION mode, each Timbre's Program still has its own X-Y Envelope which controls volume and CCs as it did in PROGRAM mode. You can disable the Program's X-Y Volume and CC control separately for each Timbre, if desired.

Program X-Y CCs affect only their own Program, even if other Timbres are set to the same MIDI channel.

There is also a separate Combi-wide X-Y Envelope, with its own X-Y Volume and CC control settings. Combi X-Y CCs affect all Timbres set to the Global channel. As with the Program X-Y, you can disable the Combi Volume and CC control separately for each Timbre.

Vector and MIDI

The Vector features interact with MIDI through the X-Y CC Control.

The **X-Y CC Control** is *generated by* the X-Y position. Normally, this will only affect internal sounds and effects. If you like, however, you can also enable a Global parameter to send these generated CCs to external MIDI devices.

Note that, in COMBINATION mode, only the Combi's X-Y CCs can be sent to external MIDI instruments; the individual Program's X-Y CCs are only used internally.

Enable CC Control [Off, On]

When this box is checked, the X-Y position will control the CCs assigned to +X, -X, +Y, and -Y, as set below.

When this box is not checked, the X-Y position will not affect these CCs. However, the X-Y control will still send and receive its dedicated MIDI CCs, just like other physical controllers. See "Vector and MIDI," above, for more information.

This parameter affects only the Combi X-Y CCs. Even if this is turned **Off**, the individual Programs' X-Y CCs will still function normally.

X-Y X Mode [Positive, Negative, Xfade, Split]

You can set up the Vector to send out CCs in several different patterns, as shown in the graphic below. This controls the pattern for the X axis.

Note that this setting affects only CC Control; it has no effect on Volume Control. Also, it applies only to the Combi X-Y CCs, and has no effect on the individual Program X-Y CCs.

Positive sends out only +X, starting at 0 at the far left, and increasing to 127 at the far right. -X is disabled in this mode.

Negative sends out only -X, starting at 0 at the far right, and increasing to 127 at the far left. In this mode, +X is grayed out.

Xfade sends out both +X and -X, overlapping throughout the X axis. As one increases, the other decreases.

Split sends out both +X and -X, with a split in the center. +X is sent when the point moves to the right of the center, and -X is sent when the point moves to the left of center.

X-Y CC Modes

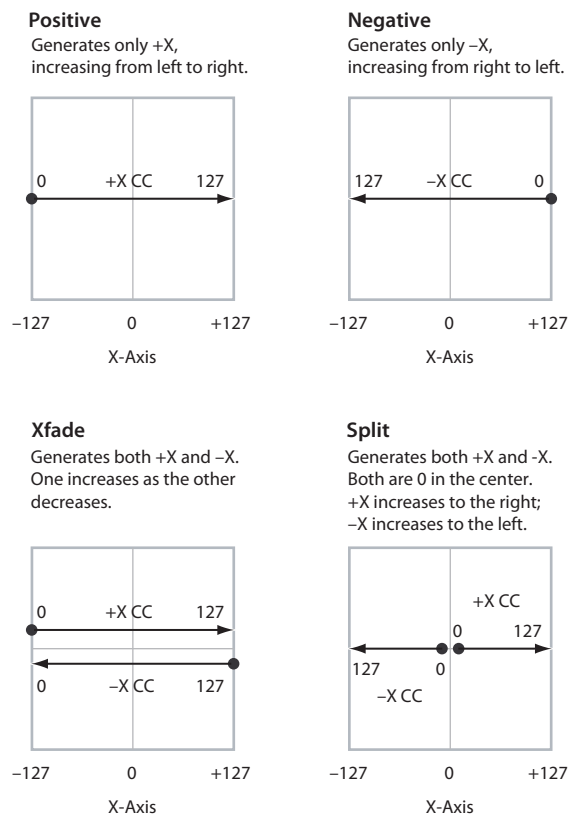

+X [Off...MIDI CC#119]

This assigns the controller sent by the +X X-Y. You can use this as an AMS source to control Program parameters, or as a Dmod source to control Effects parameters. It will be grayed out if the X-Y X Mode, above, is set to Negative.

In addition to the standard list of MIDI controllers, you can also assign the +X X-Y to duplicate the function of several front-panel controllers, including JS X, JS+X, JS-X, Knobs 1-6, and SW 1-2.

For instance, if you assign +X to Knob 6, the X-Y's +X will use the controller assigned to Knob 6 on the EQ/X-Y/Controllers- Controllers page.

Finally, you can also assign +X to control the Master Volume.

-X [Off...MIDI CC#119]

This assigns the controller sent by the -X X-Y. It will be grayed out if the X-Y X Mode, above, is set to Positive.

The selections are the same as for +X, above.

X-Y Y Mode [Positive, Negative, Xfade, Split]

This controls the X-Y CC pattern for the Y axis. For more information, see the description under X-Y X Mode, above.

+Y [Off...MIDI CC#119]

This assigns the controller sent by the +Y X-Y. It will be grayed out if the X-Y Y Mode, above, is set to Negative.

The selections are the same as for +X, above.

-Y [Off...MIDI CC#119]

This assigns the controller sent by the -Y X-Y. It will be grayed out if the X-Y Y Mode, above, is set to Positive.

The selections are the same as for +X, above.

Show Point [X-Y Control, X-Y Envelope Point 0...4]

You can view the volume and CC values for the current position of the X-Y Control, or for any of the EG's five points. This selects the point whose values will be shown.

CC at Show Point [%]

This read-only display shows the volume values for the current X-Y point, as selected by the Show Point parameter, above.

Timbre 01

Enable Combi X-Y CC [Off, On]

This controls whether or not the Timbre will receive the Combi X-Y CCs.

If this is **On**, the Timbre will receive the CCs, and the Timbre's Program will respond to them according to its own AMS settings.

If this is **Off**, the Timbre will not receive the CCs. This can be useful if the Combi's X-Y CCs are causing unwanted modulation, or conflicting with the Program's own X-Y CCs.

Enable Program X-Y CC [Off, On]

This controls whether or not the Program's own X-Y CCs will be active.

If this is **On**, the Program's X-Y CCs and X-Y Envelope will work as AMS sources, just as they did in PROGRAM mode. The CCs will not affect any other Timbres, even if they are set to the same MIDI channel.

Note that, in some cases, the X-Y CCs may have been used for modulating the Program's effects via Dmod. This functionality is not carried into the Combi; for modulating the Combi effects, use the Combi's X-Y CCs instead.

If Enable Program X-Y CC is **Off**, then the Program's X-Y CCs will have no effect. This can be useful if they are conflicting with the Combi's X-Y CCs.

Timbres 02-16

The settings for Timbres 2-16 are identical to those for Timbre 01, as described above.

✓ **1-6: Page Menu Commands**

- Compare →p.112
- Write Combination →p.433
- Exclusive Solo →p.113
- Copy From Program →p.433
- PAGE →p.126
- MODE →p.126

1-7: X-Y Envelope

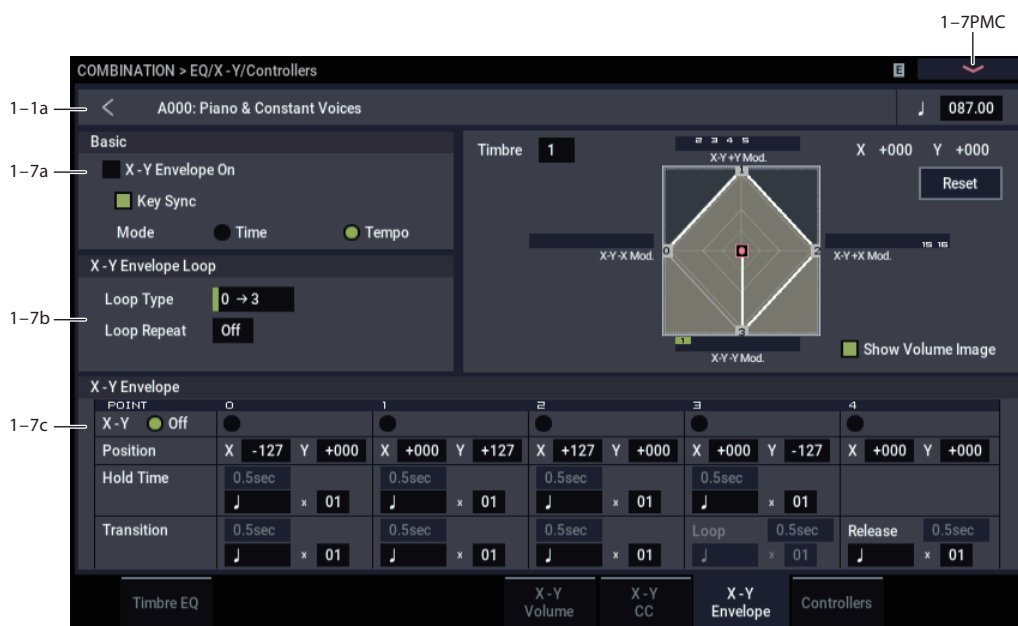

The X-Y Envelope works to control the X-Y position. It's particularly convenient for modulating effects, since it's the only Combi-wide programmable modulation source.

The X-Y Envelope is different from the other envelopes in several ways:

- Each point has two “levels” - one for the X axis, and one for the Y axis.
- The envelope times can be based on seconds and milliseconds, or synced to tempo.
- Each point has a hold time, as well as a transition time to the next point.
- The envelope can loop between two points, for either a specified number of repeats, or as long as you hold the note.

X-Y Volume and CC control use separate X-Y Envelopes

There are actually two different X-Y Envelopes, which share the same parameters: one for Volume Control, and the other for CC Control.

All of the notes on the Combi's Global Channel share a single CC Control EG. This EG starts when you first play a note, and continues as long as any notes are held down on the keyboard. When you release all of the notes, the EG goes into its release phase.

Each note then has its own, additional Volume Control X-Y Envelope, which lets you crossfade between Programs to create complex, evolving timbres. The **Key Sync** parameter applies only to this per-note EG.

When the **Key Sync** parameter is **Off**, the CC Control and Volume Control EGs are completely synchronized.

When **Key Sync** is **On**, each note's Volume Control EG will start at note-on, and go into release at note-off. All the notes will still share a single CC Control EG.

1-7a: Basic

Refer to PROGRAM mode for the respective settings.

1-7b: X-Y Envelope Loop

The X-Y Envelope can loop between two points, and can continue to loop either for as long as you hold the note, or for a specified number of repeats. You can also turn the loop off completely, if you like.

Refer to PROGRAM mode for the respective settings.

1-7c: X-Y Envelope

The X-Y Envelope has a total of five points. Since the X-Y Envelope can loop, the points are labeled differently from standard envelopes; instead of names like attack and decay, they are simply numbered 0-4.

Refer to PROGRAM mode for the respective settings.

✓ 1-7: Page Menu Commands

- Compare →p.112
- Write Combination →p.433
- Exclusive Solo →p.113
- Copy From Program →p.433
- Copy X-Y Envelope →p.119
- PAGE →p.126
- MODE →p.126

1-8: Controllers

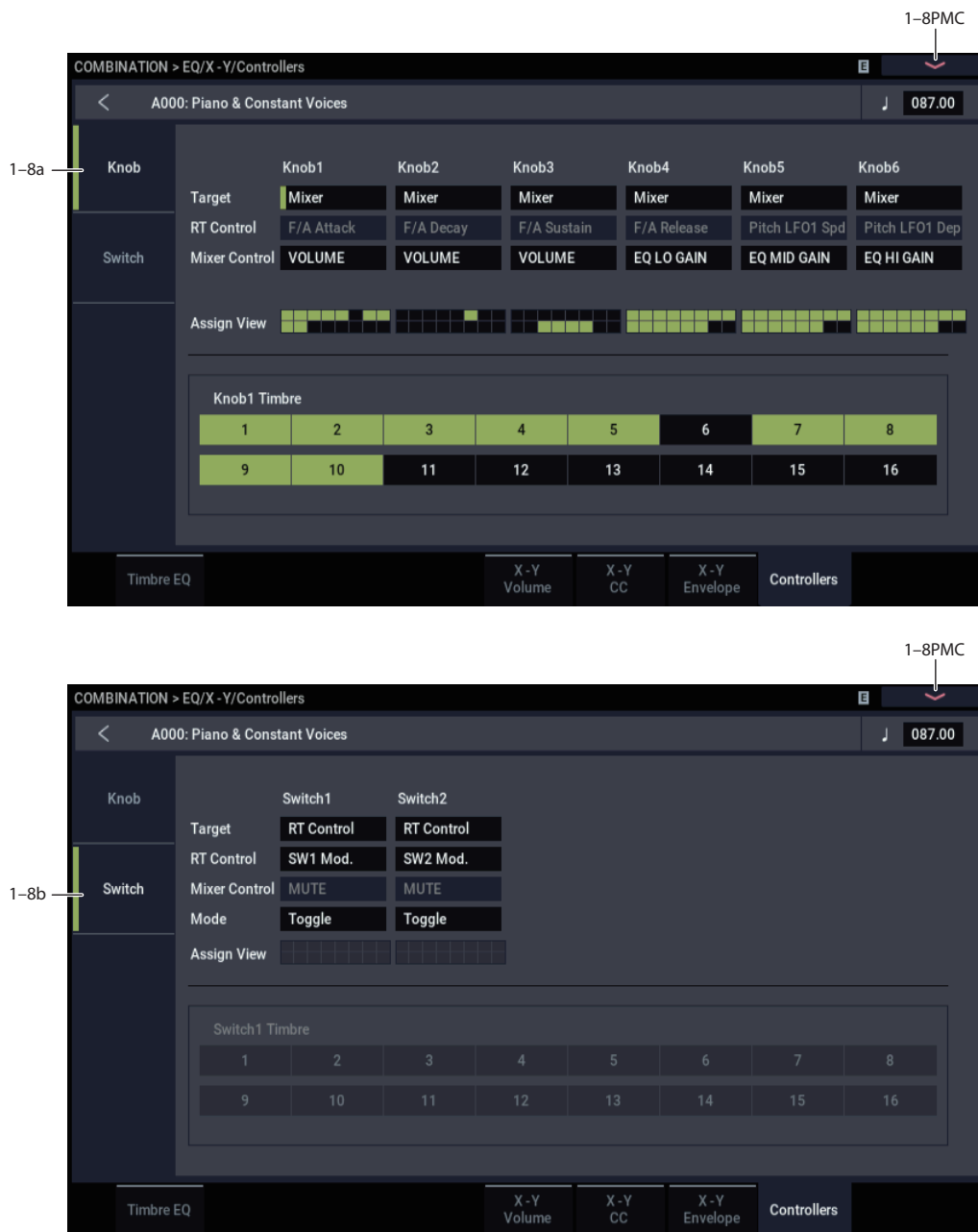

Here you can set the Combination functions of the SW1 switch, SW2 switch, and the RT control knobs 1-6. These settings are made independently for each combination.

Note: You can set the timbre in question if “Mixer Parameter” is set for the knobs or switches.

1-8a: RT Control Knob Assign

This configures the functions of the RT control knobs 1-6. Mainly, you can assign MIDI control change types here. For more information, please see “RT Control Knobs 1-6 Assignments” on page 916.

The functions that you set here are enabled when you select a USER with the SELECT button and then operate the RT control knobs 1-6. For more information, please see “1-8a: RT Control Knob Assign” on page 48.

1-8b: Panel Switch Assign

Here you can assign the function of the SW1 and SW2 buttons. For details on the functions that can be assigned, see “SW1/2 Assignments” on page 915, “1-8b: Panel Switch Assign” on page 48.

✓ 1-8: Page Menu Commands

- Compare →p.112
- Write Combination →p.433
- Exclusive Solo →p.113
- Copy From Program →p.433
- PAGE →p.126
- MODE →p.126

COMBINATION > Timbre Parameters

2-1: MIDI

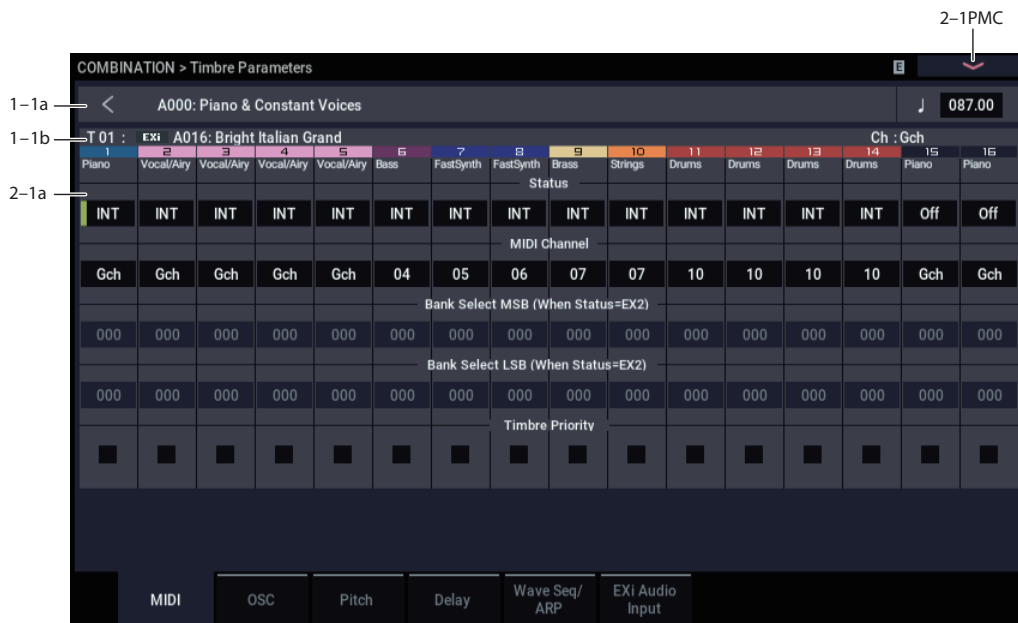

Here you can make MIDI settings for each Timbre.

2-1a: MIDI

Timbre 01

Status [Off, INT, EXT, EX2]

This specifies the MIDI and internal tone generator status.

You can also set **Status** from the Home– Mixer page. For more information, please see “Status” on page 379.

MIDI Channel [01...16, Gch]

Sets the MIDI transmit/receive channel for each timbre.

Gch: The timbre will use the channel that has been selected as the global **MIDI Channel** (GLOBAL 1-1a).

When **Status** is INT, MIDI messages will be received on the channel you specify here. If this setting is the same as the global MIDI channel, the internal tone generator will sound according to the internal settings. If this is set to EXT or EX2, playing the NAUTILUS will transmit MIDI messages on the MIDI channel specified here. (Messages will also be transmitted simultaneously on the global MIDI channel.)

Bank Select MSB (When Status = EX2) [000...127]

Bank Select LSB (When Status = EX2) [000...127]

Specifies the bank number that will be transmitted when **Status** is set to EX2. This setting has no effect if **Status** is other than EX2.

Timbre Priority [Off, On]

Sometimes, if a lot of voices are already sounding, there won't be enough free power to play a new voice. When this happens, the system stops older or lower-priority voices to free enough CPU power for the new voice. If **Timbre**

Priority is **On**, then the Timbre's voices can only be stolen by other priority voices; all voices with **Timbre Priority Off** will be stolen first.

Timbre Priority applies only to sequencing and ARP; all sounds played live from the built-in keyboard (those on the global MIDI Channel) automatically receive priority, regardless of this parameter setting.

In a Combi with many active Timbres, you can enable **Timbre Priority** for sounds with an important musical role, such as drums or bass. In general, you can enable it for any Timbre for which note stealing would adversely affect the overall sound.

Important: this setting will have little meaning if it is turned on for more than a few timbres. It's a good idea to start with **Timbre Priority** un-checked for all Timbres, and only turn it on as necessary.

On (checked): The Timbre's voices will be given priority in voice-stealing.

Off (un-checked): The Timbre's voices will not be given priority in voice-stealing.

Timbres 02...16

These are the MIDI-related settings for timbres 2 through 16. They are the same as for timbre 1. See “Timbre 01”.

✓ 2-1: Page Menu Commands

- Compare →p.112
- Write Combination →p.433
- Exclusive Solo →p.113
- Copy From Program →p.433
- PAGE →p.126
- MODE →p.126

2-2: OSC



These settings specify how each Timbre will be played.

2-2a: OSC

Timbre 01

Force OSC Mode [PRG, Poly, Mono, Legato]

This lets you override the Program’s stored Voice Assign Mode settings, if desired.

PRG: The Program’s stored **Voice Assign Mode** settings will be used. HD-1 programs will use the “1-1c: Voice Assign Mode” settings, and EXi programs will use the “EXi Common 4-1c” settings.

Poly: The timbre will play polyphonically, regardless of the Program’s settings.

Mono: The timbre will play monophonically, regardless of the Program’s settings.

Legato: The timbre program will sound monophonically, and will play legato according to the Program’s **Mode** setting (PROGRAM 1-1b).

With the Mono or Legato settings, the Program’s **Priority** setting (PROGRAM 1-1c) will determine the priority of the note that sounds when you play two or more notes.

EXi programs will ignore this setting if the program does not support the Voice Assign Mode specified by the selected Instrument Type.

AL-1: Poly, Mono, and Legato are supported.

CX-3: Poly and Mono are supported (Legato will operate as Mono)

If different Instrument Types are selected for EXi1 and 2, Mono and Legato settings will be valid only if the type is supported by both.

OSC Select [Both, OSC1, OSC2]

Specifies whether the timbre’s program will play OSC1 (EXi1), OSC2 (EXi2), or both.

For HD-1 programs whose **Oscillator Mode** (PROGRAM 1-1b) is Double, this setting lets you specify that only OSC1 or OSC2 will sound. For EXi programs in which EXi1 and EXi2 are not turned off in the Instrument Type (EXi Common 4-1), this setting lets you specify that only EXi1 or EXi2 will sound.

Both: OSC1 and 2 (or EXi1, 2) will sound as specified by the settings of the program.

OSC1: Only OSC1 (EXi1) will sound.

OSC2: Only OSC2 (EXi2) will sound. HD-1 programs will not sound if **Oscillator Mode** is set to Single or Drums. EXi programs will not sound if EXi2 is turned Off in the Instrument Type.

Portamento [PRG, Off, 001...127]

This controls the Timbre’s portamento.

PRG: Portamento will be applied as specified by the Program settings.

Off: Portamento will be off, even if the original Program settings specified for it to be on.

001...127: Portamento will be applied with the portamento time you specify here, even if it is turned off by the program settings.

Note: not all EXi support portamento, as detailed below; if they do not, then this parameter will be ignored.

AL-1, STR-1, MS-20EX, and MOD-7: portamento is supported

CX-3, PolysixEX, SGX-2, EP-1: portamento is *not* supported

This parameter can be controlled via MIDI CCs #05 and #65 (portamento time and on/off switch, respectively), subject to two conditions:

First, the Timbre’s **Status** must be set to **INT**. For more information, see “Status” on page 379.

Second, if **Portamento** is set to **PRG**, only CC#65 (on/off switch) will apply. CC#05 will be ignored.

Max # of Notes [Dynamic, 1...16]

Dynamic is the default. With this setting, you can play as many notes as the system allows.

1-16 lets you limit the maximum number of notes played by the Timbre. Voices will still be allocated dynamically, up to this maximum number. You can use this to:

- Model the voice-leading of vintage synthesizers, such as the Polysix
- Control the resources required by the Timbre, so that more voices can play on other Timbres

Max # of Notes applies only when the Program's **Voice Assign Mode** is set to **Poly**, or when **Force Osc Mode** has been set to **Poly**. With **Mono**, it has no effect.

This setting does not limit the **Unison Number of Voices**. For instance, if **Max # of Notes** is set to **6**, and **Unison Number of Voices** is set to **3**, you can play up to 6 notes, each with 3 Unison voices.

In double Programs, the **Max # of Notes** applies equally to both OSC or EXi. For instance, if **Max # of Notes** is set to **4**, you can play up to 4 notes on each OSC/EXi.

Timbres 02... 16

Here you can make voice assignment settings for timbres 2 through 16. The settings are the same as for timbre 1. See "Timbre 01".

✓ 2-2: Page Menu Commands

- Compare →p.112
- Write Combination →p.433
- Exclusive Solo →p.113
- Copy From Program →p.433
- PAGE →p.126
- MODE →p.126

2-3: Pitch

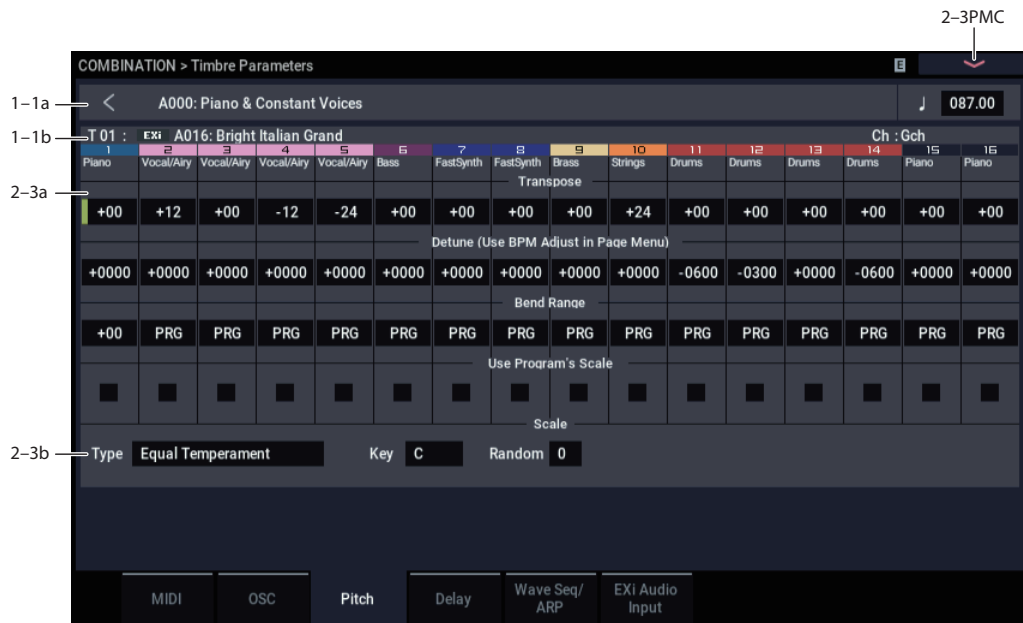

Here you can make pitch-related settings for each timbre.

2-3a: Pitch

Timbre 01

Transpose [-60...+00...+60]

Adjusts the pitch of each timbre in semitone steps.
12 units equal one octave.

MIDI When **Status** (0-1b, 2-1a) is INT, this parameter will affect the pitches sounded by the NAUTILUS. When **Status** is EXT, this parameter will affect the note numbers of the MIDI note messages that are transmitted.

For example if you make settings of +04 and +07 respectively for two timbres that are set to EXT, playing the C key will transmit a C note number on the global MIDI channel, and at the same time will also transmit E and G note numbers on the MIDI channels of those timbres.

Detune (Use BPM Adj. in Page Menu) [-1200...+0000...+1200]

Adjusts the pitch of each timbre in one-cent units.
+0000: Normal pitch.

Note: You can also use the **Detune BPM Adjust** menu command to alter a loop's tempo via detuning. Since this will alter the pitch of the loop along with the tempo, it's generally suited only to un-pitched percussive loops. For more information, see "Detune BPM Adjust" on page 437.

MIDI **Transpose** and **Detune** can be controlled via MIDI RPN messages. The way that this works depends on whether or not the Timbre uses an HD-1 Drum Program.

If the Timbre does not use an HD-1 Drum Program—for example, if it uses a Single or Double HD-1 Program, or an EXi Program—then MIDI RPN Coarse Tune will control **Transpose**, and RPN Fine Tune will control **Detune**.

If the Timbre uses an HD-1 Drum Program, MIDI RPN Coarse Tune and Fine Tune will be combined to control **Detune**. The overall range is ±1 octave for coarse tune and fine tune together.

Bend Range [PRG, -24...+00...+24]

Specifies the amount of pitch change that will occur when the pitch bender is operated, in semitones.

PRG: The pitch range specified by the program will be used.
-24...+24: This setting will be used regardless of the setting in the program.

MIDI The MIDI RPN Pitch Bend Change message can be received to control this and change the setting. (However it will not be received if this parameter is set to PRG.) This message is received on the MIDI channel for each timbre set by **MIDI Channel** (2-1a).

Use Program's Scale [Off, On]

Timbre can use the scale that is specified by *Scale* (PROGRAM 1-1c).

On (checked): The scale specified by the program will be used.

Off (unchecked): The scale specified by *Scale* (2-3b) will be used.

Timbres 02... 16

These are the pitch-related settings for timbres 2 through 16. The settings are the same as for timbre 1. For more information, see "Timbre 01".

2-3b: Combination's Scale

This specifies the scale that the combination will use. For more information, please see "1-1e: Scale" on page 38.

Type (Combi's Scale) [Equal Temperament...User Octave Scale15]

Selects the scale.

Key [C...B]

Selects the tonic key of the selected scale.

Random [0...7]

As this value is increased, an increasingly random deviation will be added to the pitch at each note-on.

2-3: Page Menu Commands

- Compare →p.112
- Write Combination →p.433
- Exclusive Solo →p.113
- Copy From Program →p.433
- Detune BPM Adjust →p.437
- PAGE →p.126
- MODE →p.126

2-4: Delay

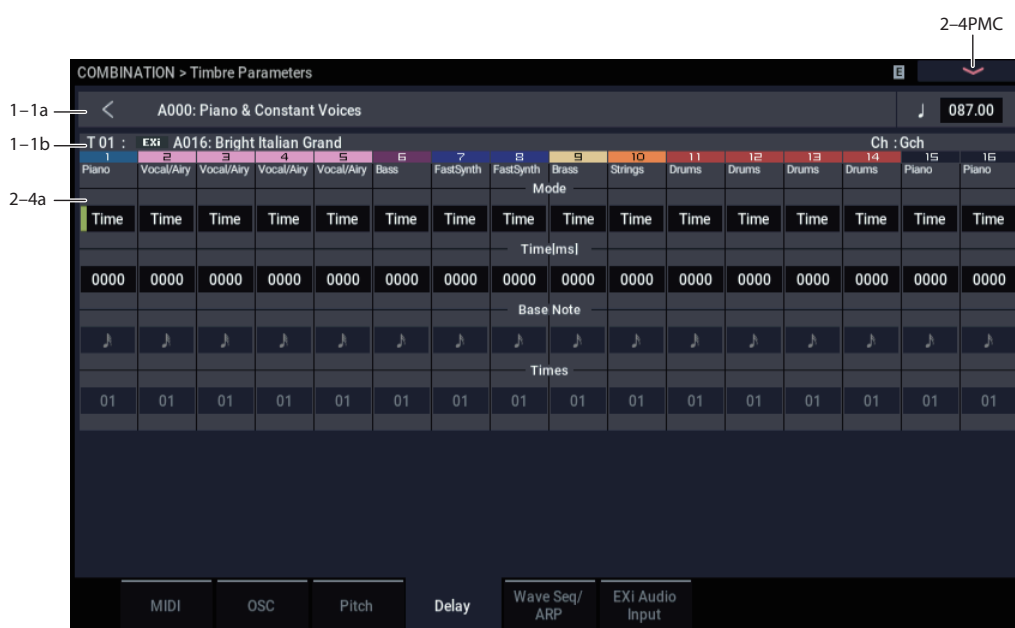

This specifies the time (delay) from when the timbre receives a note-on until the sound begins.

2-4a: Delay

Timbre 01

Mode [Time, Tempo]

Chooses the unit in which you will specify delay time.

Time: Specify the delay time in units of milliseconds (ms = 1/1000th of a second).

Tempo: Specify the delay time in terms of a **Base Note** and **Times** relative to the **Tempo**. For example if **Base Note** = ♩, **Times** = 01, and **Tempo** = 60 BPM, the delay time will be equivalent to 1000 ms.

Time [ms] [0000...6000ms, KeyOff]

Specifies the delay time from note-on until the Timbre begins to produce sound, in units of ms (1/1000th of a second). This setting is available if **Mode** is set to Time. The default is 0000.

KeyOff: The note will begin sounding at note-off. In this case, the sound will not die away if the sustain level of the program's amp EG is other than 0. This setting is used when creating harpsichord sounds.

Base Note [♪...♩]

Times [01...32]

This setting is available when **Mode** is set to **Tempo**. It specifies the delay time from note-on until the timbre begins to produce sound, in terms of a note value relative to the **Tempo** (♪) (0-1a).

Use **Base Note** to specify the desired note value, and use **Times** to extend that note value by the specified multiple.

For example, if you set **Base Note** to a quarter note (♪) and **Times** to 02, the timbre will sound with a delay of a half note (♩)—even if you change **Tempo** (♪). In this case, a **Tempo** of 60.00 BPM will produce a 2000 ms delay, and a **Tempo** of 120.00 BPM will produce a 1000 ms delay.

Timbres 02...16

These are the delay time settings for Timbres 2 through 16. They are the same as for Timbre 1, as described above.

✓ 2-4: Page Menu Commands

- Compare →p.112
- Write Combination →p.433
- Exclusive Solo →p.113
- Copy From Program →p.433
- PAGE →p.126
- MODE →p.126

2-5: Wave Seq/ARP

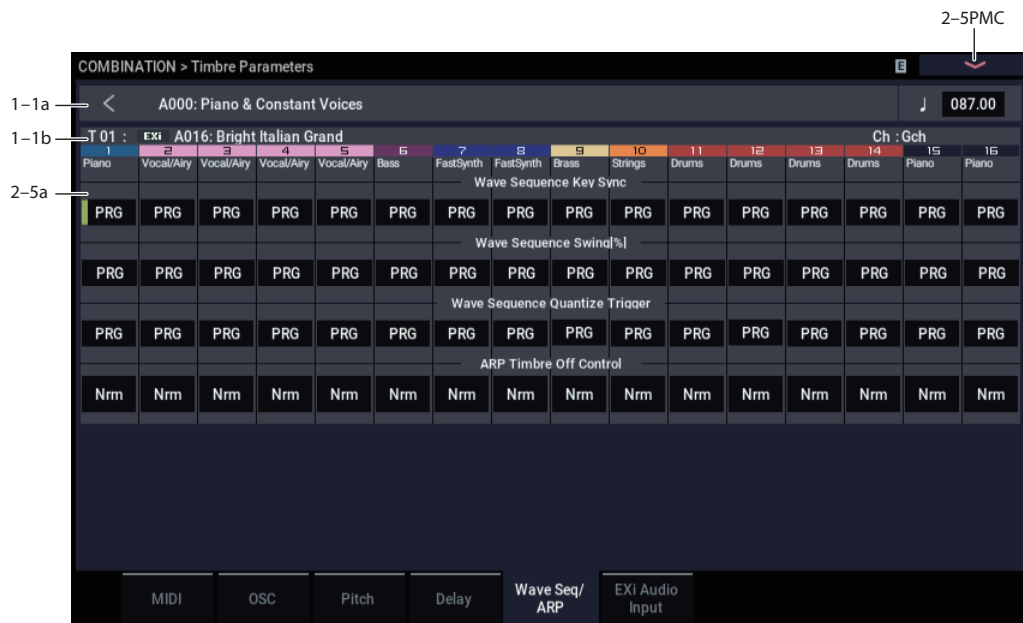

Here you can make settings related to wave sequence and Arpeggiator functionality for each timbre.

2-5a: Wave Sequence/ARP

Timbre 01

Wave Sequence Key Sync [PRG, Off, On]

Specifies the wave sequence **Key Sync** setting (PROGRAM 1-1e) of the program selected for the timbre. This setting is valid if the program uses a wave sequence.

PRG: The setting of the program is used.

Off: **Key Sync** is forced off. The wave sequence of each note will synchronize to the same step.

On: **Key Sync** is forced on. The wave sequence will start each time you press a key. If the wave sequences have differing steps or rates, they will proceed independently.

Wave Sequence Swing[%] [PRG, -300...+300]

Specifies the wave sequence “Swing%” setting (PROGRAM 1-1e) of the program selected for the timbre. This setting is valid if the program uses a wave sequence.

PRG: The setting of the program is used.

-300...+300: The Swing% specified here is used regardless of the program’s “Swing” setting.

For more information, please see “Swing” on page 39.

Wave Sequence Quantize Trigger [PRG, Off, On]

This allows you to override the Program’s Wave Sequence “Quantize Trigger” setting (PROGRAM 1-1d). If you’re using multiple Programs with rhythmic Wave Sequences, you can use this to synchronize all of the Wave Sequences at note-on.

Note that Quantize Trigger applies only when the Wave Sequence’s **Mode** is set to Tempo. For more information, see “Mode” on page 657.

PRG: The setting of the program is used.

Off: “Quantize Trigger” is forced off. The wave sequence will trigger immediately after note-on.

On: “Quantize Trigger” is forced on. The wave sequence pattern will synchronize to eighth-note timing of the currently-sounding wave sequence; i.e., the trigger will be quantized.

For more information, please see “Quantize Trigger” on page 39.

ARP Timbre Off Control

[Normal, Timbre Off by ARP Off, Timbre Off by ARP On]

Nrm (Normal): The ARP button will not control whether a timbre will sound. Normally you will select Normal.

by Off (Timbre Off by ARP Off): The timbre will sound as usual when the ARP button is on.

The timbre will not sound when the ARP button is off.

Use this when you want a specific timbre of multiple timbres set to the same MIDI channel to be silent only when Arpeggiator is off.

by On (Timbre Off by ARP On): The timbre will not sound when the ARP button is on. The timbre will sound as usual when the ARP button is off.

Use this when you are using an arpeggiator to control multiple timbres that are set to the same MIDI channel, and want a specific timbre to be silent only when Arpeggiator is on.

For example you can use this to play a two-timbre layer from the keyboard when Arpeggiator is off, and use one timbre to sound the phrase when Arpeggiator is on.

If the **Status** (0-1b) of each timbre is INT, you can use the **Timbre Off Control** setting to stop the oscillator of each timbre from sounding.

Timbres 02...16

These are the wave sequence and Arpeggiator-related settings for timbres 2 through 16. They are the same as for timbre 1. See "Timbre 01".

✓ 2-5: Page Menu Commands

- Compare →p.112
- Write Combination →p.433
- Exclusive Solo →p.113
- Copy From Program →p.433
- PAGE →p.126
- MODE →p.126

2-6: EXi Audio Input

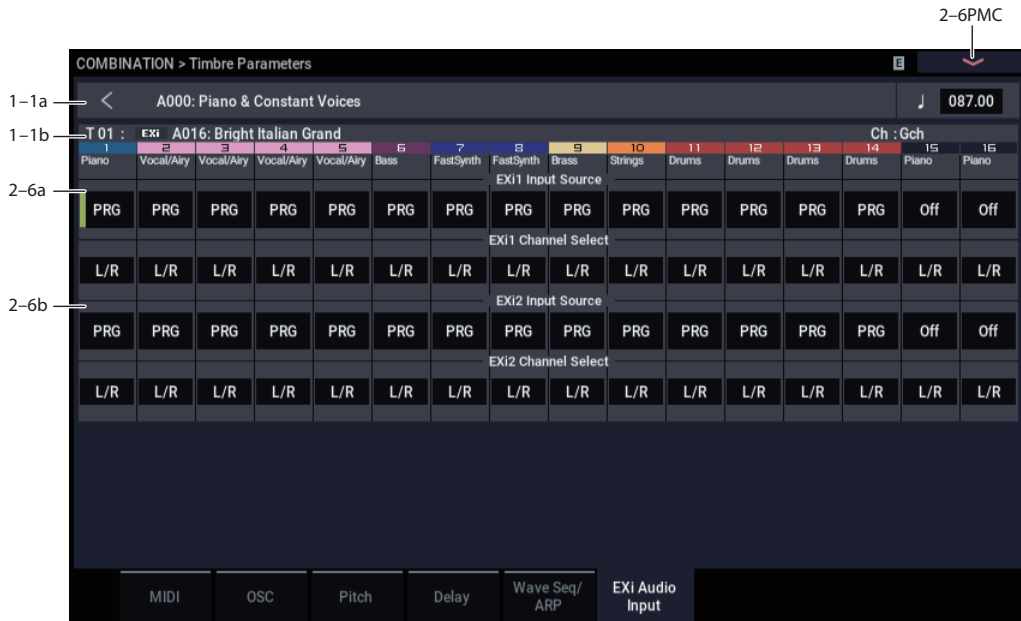

These parameters let you route audio into EXi instruments which support audio input, including the STR-1, MS-20EX, and MOD-7. You can use this to create feedback loops, or to process live or recorded audio through the EXi’s synthesis engine.

EXi which do not support audio input will ignore these settings. The AL-1 supports audio input, but uses its own dedicated routing which is not affected by these parameters.

For more information on using audio inputs with EXi, see:

- AL-1: “4-3c: Sub OSC/Audio Input” on page 149
- STR-1: “4-8c: Feedback” on page 231
- MS-20EX: “6-1k: EXTERNAL SIGNAL PROCESSOR (ESP)” on page 273
- MOD-7: “5-1f: EXi Audio Input” on page 319

2-6a: EXi 1

Input Source [PRG, Off, Audio Input 1/2, USB 1/2, L/R Output, Indiv. Output 1/2...3/4, REC 1/2...3/4, FX Control 1, 2, IFX 1...12, MFX 1, 2, TFX 1, 2]

This selects the input source for EXi1. You can use this to create a feedback loop, if desired.

PRG uses the setting stored in the Program. For more information, see “4-2: EXi Audio Input” on page 134.

Off disables the input.

Audio Input 1/2, and **USB 1/2** use the live audio from the selected input.

L/R Output and **Indiv. Output 1/2...3/4** use the audio as it is heard from the selected output (like connecting a cable from the output back to the input).

REC 1/2...3/4 and **FX Control 1, 2** use the audio from the selected bus.

IFX 1...12, **MFX 1, 2**, and **TFX 1, 2** use the output of the selected effect.

Channel Select [Stereo/L+R, Left, Right]

Stereo/L+R: This selection routes a stereo signal to EXi with stereo inputs, and an L+R summation to EXi with mono inputs.

Left, Right: This uses only a mono signal from the selected channel.

2-6b: EXi 2

EXi2 has the same controls as EXi1, above.

✓ 2-6: Page Menu Commands

- Compare →p.112
- Write Combination →p.433
- Exclusive Solo →p.113
- Copy From Program →p.433
- PAGE →p.126
- MODE →p.126

COMBINATION > MIDI Filter/Zones

3-1: MIDI Filter1



These settings allow you to apply filters to the MIDI data that will be transmitted and received by each timbre 1–16. For example even if two timbres are being played by the same MIDI channel, you can make settings so that the damper pedal will apply to one but not the other.

On (checked): Transmission and reception of MIDI data is enabled.

When **Status** (0–1b, 2–1a) is INT, operation of the built-in controllers or incoming MIDI data will apply the effect of the checked item to the program of the corresponding timbre. (The effect dynamic modulation function is not affected by this setting.)

In the case of EXT or EX2, operating a controller on the NAUTILUS will transmit MIDI data on the channel of that timbre. MIDI transmission/reception settings for the entire NAUTILUS can be made in “MIDI Filter” (GLOBAL 1–1b).

The MIDI Filter pages 2 and 3 contain MIDI filters for assignable controllers (whose function can be set by the user), and if these are assigned to MIDI control changes, the filter settings will affect those control changes. In this case, if the same control change as Knob 1, 2, 3, or 4 has been assigned in MIDI Filter pages 1 and 2, the settings in MIDI Filter pages 1 and 2 will take priority. Also, if the same control change is assigned to two or more controllers in the MIDI Filter pages 2 and 3, checking any one of them will enable that control change.

Off (unchecked): Transmission and reception of MIDI data is disabled.

Note: MIDI CC# = MIDI control change message numbers.

3-1a: MIDI Filter1

*Timbre 01***Enable Program Change** [Off, On]

Specifies whether or not MIDI program change messages will be transmitted and received.

Enable After Touch [Off, On]

Specifies whether or not MIDI after touch messages will be received.

Enable Damper [Off, On]

Specifies whether or not MIDI CC#64 hold (damper pedal) messages will be transmitted and received.

Enable Portamento SW [Off, On]

Specifies whether or not MIDI CC#65 portamento on/off messages will be transmitted and received.

Enable JS X as AMS [Off, On]

Specifies whether or not MIDI pitch bend messages (the X axis of the NAUTILUS’s joystick) will be received to control the AMS effect assigned to JS X. (This is not a filter for MIDI pitch bend message reception.) For more information, please see “Alternate Modulation Sources (AMS)” on page 901.

Enable JS+Y [Off, On]

Specifies whether MIDI CC#01 (the +Y axis of the NAUTILUS’s joystick setting) will be transmitted and received.

Enable JS-Y [Off, On]

Specifies whether MIDI CC#02 (the -Y axis of the NAUTILUS's joystick setting) will be transmitted and received.

Enable Ribbon [Off, On]

Specifies whether or not MIDI CC#16 will be transmitted or received.

Note: MIDI CC#16 can also be transmitted and received by assigning each MIDI CC# to the RT control knobs or foot pedal. For more information, please see "Controller Assignments" on page 915.

Timbres 02...16

These are the MIDI Filter1 settings for timbres 2 through 16. They are the same as for timbre 1. See "Timbre 01".

✓ 3-1: Page Menu Commands

- Compare →p.112
- Write Combination →p.433
- Exclusive Solo →p.113
- Copy From Program →p.433
- PAGE →p.126
- MODE →p.126

3-2: MIDI Filter2



3-2a: MIDI Filter2

Timbre 01

Enable Realtime Control Knob 1 [Off, On]

Sets whether to receive MIDI CC#74 (the filter cutoff frequency of the NAUTILUS) from RT control knob 1 when you use the SELECT button to select "SOUND".

Enable Realtime Control Knob 2 [Off, On]

Sets whether to receive MIDI CC#71 (the filter resonance level of the NAUTILUS) from RT control knob 2 when you select "SOUND" with the SELECT button.

Enable Realtime Control Knob 3 [Off, On]

Sets whether to receive MIDI CC#79 (the filter EG intensity of the NAUTILUS) from RT control knob 3 when you select "SOUND" with the SELECT button.

Enable Realtime Control Knob 4 [Off, On]

Sets whether to receive MIDI CC#72 (the filter/amp EG release times of the NAUTILUS) from RT control knob 4 when you select "SOUND" with the SELECT button.

Enable Realtime Control Knob 5 [Off, On]

Sets whether to receive MIDI CC#20 (EFFECT) from RT control knob 5 when you select "SOUND" with the SELECT button.

Enable Realtime Control Knob 6 [Off, On]

Sets whether to receive MIDI CC#21 (REVERB) from RT control knob 6 when you select "SOUND" with the SELECT button.

Timbres 02...16

These are the MIDI Filter2 settings for timbres 2 through 16. They are the same as for timbre 1. See "Timbre 01".

✓ 3-2: Page Menu Commands

- Compare →p.112
- Write Combination →p.433
- Exclusive Solo →p.113
- Copy From Program →p.433
- PAGE →p.126
- MODE →p.126

3-3: MIDI Filter3



3-3a: MIDI Filter3

Timbre 01

Enable SW1 [Off, On]

Enable SW2 [Off, On]

Specifies whether or not the effect of the SW1 and SW2 switches will be received.

The function of these switches is specified in the EQ/X-Y/Controllers- Controllers page.

These settings are valid if these keys are assigned to SW1 Mod. (CC#80), SW2 Mod. (CC#81), or Portamento SW (CC#65).

Enable Foot Switch [Off, On]

Specifies whether or not the effect of the ASSIGNABLE SWITCH will be received. The function is assigned in GLOBAL > Controllers/Scales page.

This filter setting is valid when a MIDI control change is assigned.

Enable Foot Pedal [Off, On]

Specifies whether or not the effect of the ASSIGNABLE PEDAL will be received. The function is assigned in GLOBAL > Controllers/Scales page.

This filter setting is valid when a MIDI control change is assigned.

Enable Other Control Change Messages [Off, On]

Specifies whether or not MIDI control messages not covered in the preceding items MIDI Filter will be received.

Timbres 02... 16

These are the MIDI Filter3 settings for timbres 2 through 16. They are the same as for timbre 1. See “Timbre 01”.

3-3: Page Menu Commands

- Compare →p.112
- Write Combination →p.433
- Exclusive Solo →p.113
- Copy From Program →p.433
- PAGE →p.126
- MODE →p.126

3-5: Keyboard Zones

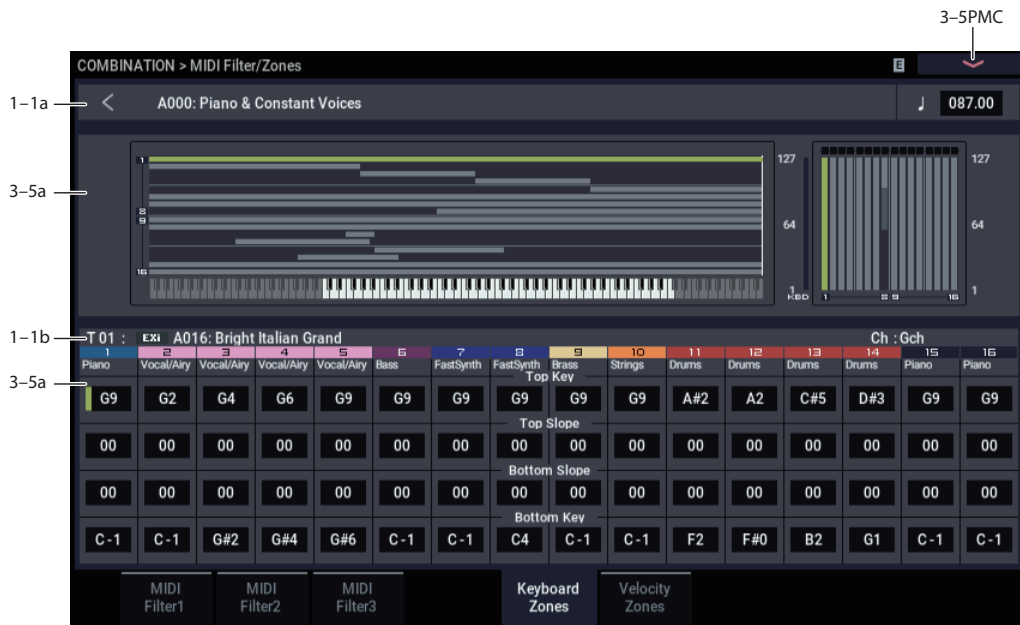

These settings specify the keyboard range in which each timbre will sound.

The top/bottom key parameters specify the range of notes in which timbres 1-16 will sound, and the top/bottom slope parameters specify the range over which the original volume will be reached.

Key Split: By setting timbres of different sounds to ranges that do not overlap, you can play different sounds in different ranges of the keyboard.

Layer: By setting the ranges to overlap, you can play two or more sounds with a single note.

Positional Cross-fade: If you set the slopes (the grayed portion) to overlap, the sounds will overlap, and the proportion of the overlap will change according to the keyboard location.

3-5a: Zone Map

This area provides a graphic display of the note and velocity ranges in which each MIDI Track will sound. The slope portions of the zones are displayed in a different color.

Under the Key Zone graphic, a keyboard graphic shows the most recently-played note in green, aligned with the keyboard zones.

To the left of the Velocity Zone graphic, a meter shows the velocity of the most recently-played note; red dots above the graphic show the Zone(s) triggered by that velocity.

Zone Map

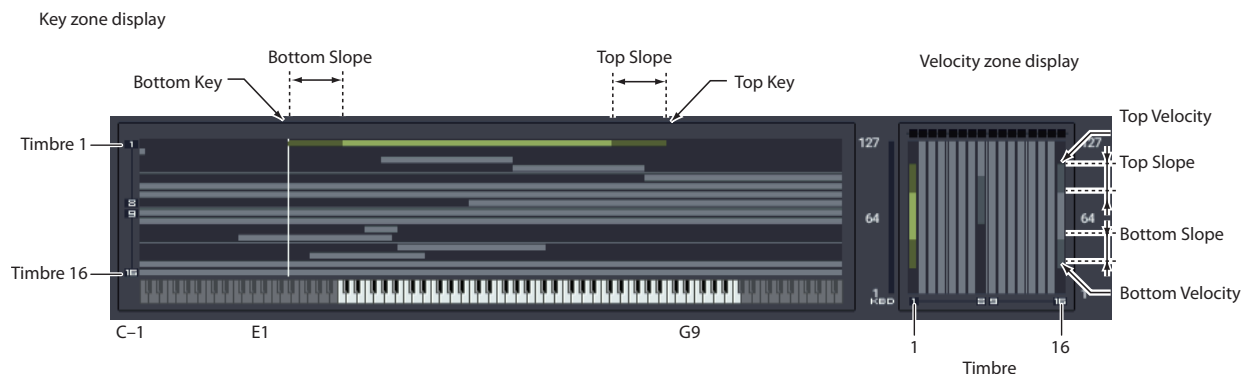

3-5b: Keyboard Zones

Timbre 01

Top Key [C-1...G9]

Specifies the top key (upper limit) of the notes that will sound each timbre.

Top Slope [00, 01, 02, 03, 04, 06, 08, 10, 12, 18, 24, 30, 36, 48, 60, 72]

Specifies the range of keys (12 is one octave) over which the volume will be reached starting from the top key.

0: The volume will be at the original level from the top key.

12: The volume will increase gradually as you play downward, and will reach the original volume one octave below the top key.

72: The volume will increase gradually as you play downward, and will reach the original volume six octaves below the top key.

Bottom Slope [00, 01, 02, 03, 04, 06, 08, 10, 12, 18, 24, 30, 36, 48, 60, 72]

Specifies the range of keys (12 is one octave) over which the volume will be reached starting from the bottom key.

0: The volume will be at the original level from the bottom key.

12: The volume will increase gradually as you play upward, and will reach the original volume one octave above the bottom key.

72: The volume will increase gradually as you play upward, and will reach the original volume six octaves above the bottom key.

Bottom Key [C-1...G9]

Specifies the bottom key (lower limit) of the notes that will sound each timbre.

How volume will change according to keyboard location

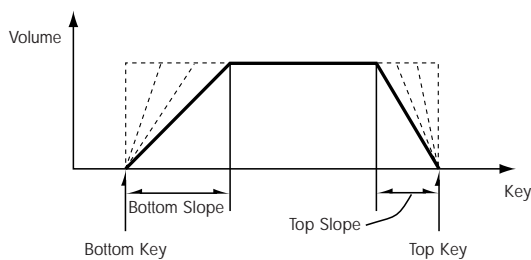

Top Key and **Bottom Key** settings can also be input by holding down the ENTER button and playing a note on the keyboard.

 It is not possible to set the bottom key above the top key of the same timbre. Nor is it possible for the top and bottom slopes to overlap.

Timbres 02...16

These are the key zone settings for timbres 2 through 16. They are the same as for timbre 1. See “Timbre 01”.

✓ 3-5: Page Menu Commands

- Compare →p.112
- Write Combination →p.433
- Exclusive Solo →p.113
- Copy From Program →p.433
- PAGE →p.126
- MODE →p.126

3–6: Velocity Zones

COMBINATION > MIDI Filter/Zones

3-6PMC

1-1a

3-6a

1-1b

3-6a

| T 01 | EXI | A016: Bright Italian Grand | | | | | | | | | | | | | |
|-----------------|------------|----------------------------|------------|------------|------|-----------|-----------|----------|---------|-------|-------|-------|-------|-------|-------|
| 1 | 2 | 3 | 4 | 5 | 6 | 7 | 8 | 9 | 10 | 11 | 12 | 13 | 14 | 15 | 16 |
| Piano | Vocal/Airy | Vocal/Airy | Vocal/Airy | Vocal/Airy | Bass | FastSynth | FastSynth | Brass | Strings | Drums | Drums | Drums | Drums | Piano | Piano |
| 108 | 127 | 127 | 127 | 127 | 127 | 127 | 127 | 127 | 127 | 127 | 127 | 127 | 127 | 127 | 108 |
| Top Velocity | | | | | | | | Ch : Gch | | | | | | | |
| Top Slope | | | | | | | | | | | | | | | |
| 024 | 000 | 000 | 000 | 000 | 000 | 000 | 000 | 000 | 000 | 000 | 000 | 000 | 000 | 000 | 024 |
| Bottom Slope | | | | | | | | | | | | | | | |
| 024 | 000 | 000 | 000 | 000 | 000 | 000 | 000 | 040 | 000 | 000 | 000 | 000 | 000 | 000 | 024 |
| Bottom Velocity | | | | | | | | | | | | | | | |
| 022 | 001 | 001 | 001 | 001 | 001 | 001 | 001 | 059 | 001 | 001 | 001 | 001 | 001 | 001 | 022 |

Sets the Top/Bottom Velocity parameters to specify the range of velocities that will sound for each timbre 1–16, and set the Top/Bottom Slope parameters to specify the range over which the volume will change.

Velocity Switch: By setting two or more timbres to velocity zones that do not overlap, you can use variations in playing dynamics to play different sounds.

Layer: If you set two or more timbres to velocity zones that overlap, the sounds will be heard together.

Velocity Cross-fade: If the slope ranges (gray line) overlap, different sounds will be sounded together, and your playing dynamics will determine the proportion of each sound.

⚠ It is not possible to set the bottom velocity greater than the top velocity for the same timbre. Nor can the top slope and the bottom slope overlap.

3–6a: Zone Map

This area provides a graphic display of the note and velocity ranges in which each MIDI Track will sound. The slope portions of the zones are displayed in a different color.

Under the Key Zone graphic, a keyboard graphic shows the most recently-played note in green, aligned with the keyboard zones.

To the left of the Velocity Zone graphic, a meter shows the velocity of the most recently-played note; red dots above the graphic show the Zone(s) triggered by that velocity.

For more information, please see “3–5a: Zone Map” on page 417.

3–6b: Velocity Zones

Timbre 01

Top Velocity [1...127]

Specifies the maximum velocity value that will sound each timbre.

Top Slope [0...120]

Specifies the number of velocity steps over which the original volume will be reached, starting from the Top Velocity.

0: The volume will be at the original value from the top velocity.

120: The volume will decrease as the velocity approaches the top velocity.

Bottom Slope [0...120]

Specifies the number of velocity steps over which the original volume will be reached, starting from the Bottom Velocity.

0: The volume will be at the original value from the bottom velocity.

120: The volume will decrease as the velocity approaches the bottom velocity.

Bottom Velocity [1...127]

Specifies the minimum velocity value that will sound each timbre.

How volume will change according to keyboard location

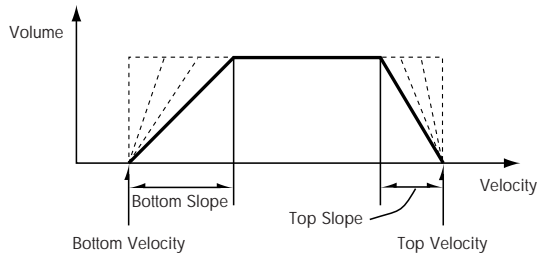

“Top Velocity” and “Bottom Velocity” settings can also be input by holding down the ENTER button and playing a note on the keyboard.

Timbres 02...16

These are the velocity zone settings for timbres 2 through 16. They are the same as for timbre 1. See “Timbre 01”.

✓ 3-6: Page Menu Commands

- Compare →p.112
- Write Combination →p.433
- Exclusive Solo →p.113
- Copy From Program →p.433

- PAGE →p.126
- MODE →p.126

COMBINATION > IFX

You can also specify the bus routing for the program used by each timbre 1–16. For instance, you can:

- Send the output of a timbre to an insert effect
- Route a sound to an insert effect

- Make detailed settings for insert effects
- Make common LFO settings for effects

For more details on the Insert Effects, see the “Effect Guide” on page 731.

8-1: Routing1

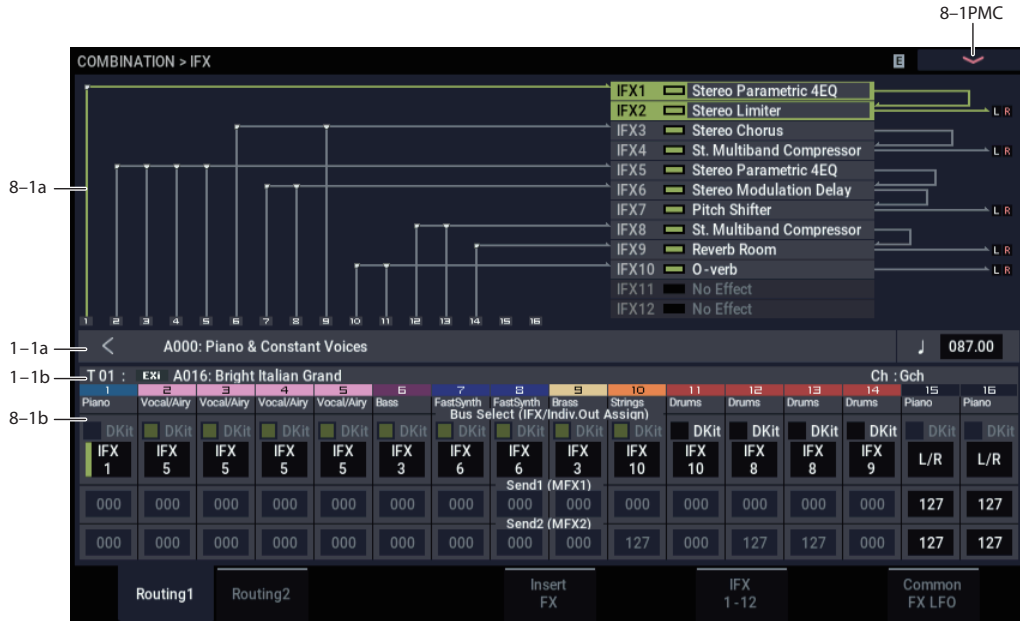

Specifies the bus to which the program oscillator(s) used by each timbre 1–16 will be sent. You can also set the send levels to the master effects from this page.

8-1a: Routing Map

This shows the status of the insert effects.

This area shows the insert effect routing (Bus Select), the name of the assigned effect, the on/off status, chaining, and the output bus that follows the insert effect. The type of insert effect, the on/off status, and the chain settings can be edited in the IFX– Insert FX page.

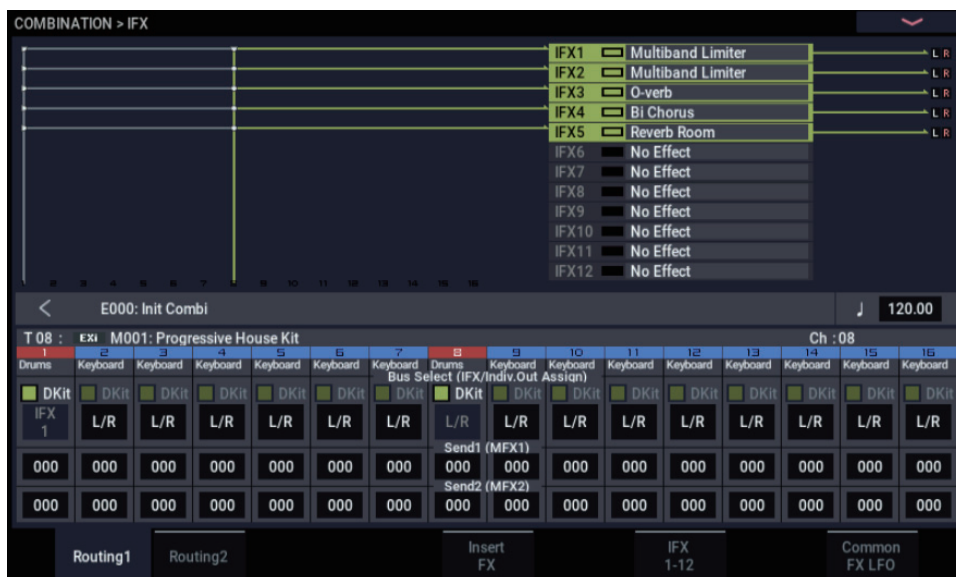

8-1b: Routing1

Timbre 01 (Timbre Number)

Bus Select (IFX/Indiv. Out Assign) Dkit [Off, On]

You can select this only if the Timbre's Program is a drum program (**Oscillator Mode Drums**). This parameter can also be edited from the IFX-Routing 2 page.

On (checked): The **Bus Select (IFX/Indiv.Out Assign)**, **FX Control Bus**, **Send1 (to MFX1)**, and **Send2 (to MFX2)** settings for each key of the selected drum kit will be used. Check this setting if you want to apply an individual insert effect to each drum instrument, or to send individual drum instruments to AUDIO OUTPUT (INDIVIDUAL).

Tip: In most preloaded drumkits, the drum instruments have the same **Bus Select** settings according to their type, as follows.

- Snares → IFX1
- Kicks → IFX2
- Toms → IFX3
- Cymbals → IFX4
- Percussion, etc. → IFX5

If you want to edit these routings, use the **Drum Kit IFX Patch** page menu command.

Off (unchecked): The **Bus Select (IFX/Indiv.Out Assign)**, **FX Control Bus**, **Send1 (to MFX1)**, and **Send2 (to MFX2)** settings will be used. All drum instruments will be sent to the specified bus.



Bus Select (IFX/Indiv.Out Assign)

[L/R, IFX1...12, 1...4, 1/2...3/4, Off]

This specifies the output bus for the timbre's program oscillator. This parameter can also be edited from the IFX-Routing 2 page.

L/R: Output to the L/R bus.

IFX1...12: Output to the IFX1-12 buses.

1...4: The timbre will be sent in mono to the corresponding Individual output.

1/2, 3/4: The timbre will be output in stereo according to its pan setting from the corresponding AUDIO OUTPUT (INDIVIDUAL) pairs 1/2, 3/4.

Off: The timbre will not be output from the L/R bus, IFX1-12 buses, or Individual 1-4 buses. Choose the Off setting if you want the program oscillator output of the timbre to be connected in series to a master effect. Use **Send1 (to MFX1)** and **Send2 (to MFX2)** to specify the send levels.

Tip: You can create a wide variety of routings by using each timbre's **Bus Select** and the **Chain to** and **Chain** settings (5-5a) that follow the insert effect.



Example: Inserting a single IFX into multiple timbre

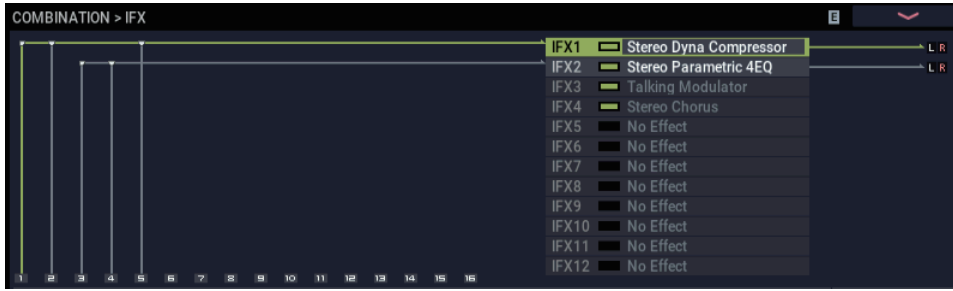

Example: Inserting a separate IFX into each timbre, and then inserting an IFX at the final stage

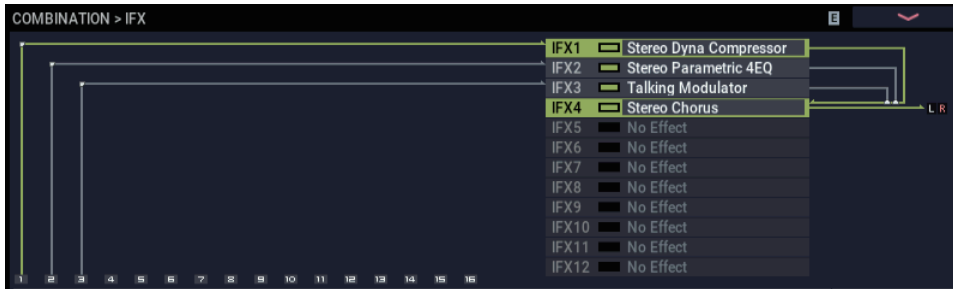

Example: Sharing a portion of a timbre's IFX chain with another timbre

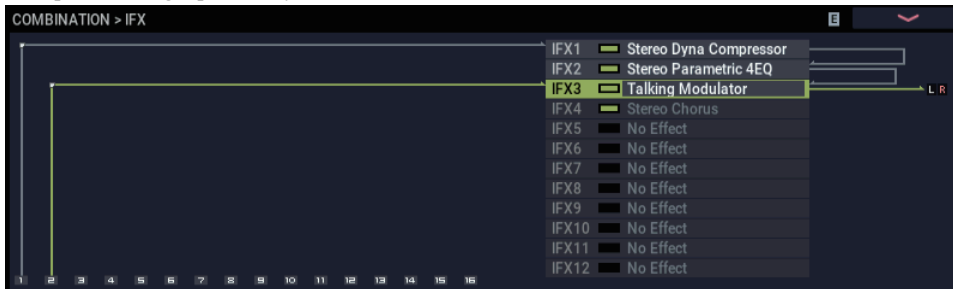

Send1 (MF1) [000...127]

Send2 (MF2) [000...127]

For each timbre, these parameters set the send level to master effects 1 and 2. These settings are valid when **Bus Select** is set to L/R or Off. When IFX 1–12 are selected, the send levels to master effects 1 and 2 are set by the **Send1** and **Send2** parameters of the Insert FX page, after the sound has passed through IFX1–12.

If **Bus Select** is set to 1...4 or 1/2...3/4, these settings are ignored.

MIDI Control change CC#93 can be used to control the Send 1 level, and CC#91 to control the Send 2, and modify their respective settings. These messages will be received on the MIDI channel specified for each timbre in the Timbre Parameters– MIDI channel page.

The actual send levels are determined by multiplying this value with the send level **Send1** and **Send2** (PROGRAM 8-1f, 8-5b) for each oscillator of the program selected for the timbre.

Timbre 02... 16 (Timbre Number)

These settings specify the program oscillator output bus and master effect send levels for timbres 2 through 16. They are the same as for timbre 1. See “Timbre 01”.

✓ 8-1: Page Menu Commands

- Compare →p.112
- Write Combination →p.433
- Exclusive Solo →p.113
- Copy Insert Effect →p.122
- Swap Insert Effect →p.123
- Drum Kit IFX Patch →p.438
- PAGE →p.126
- MODE →p.126

8-2: Routing2



Here you can specify the program oscillator output bus, effect control bus, and REC bus for each timbre 1 through 16.

8-2a: Routing2

Timbre 01 (Timbre Number)

Bus Select (IFX/Indiv. Out Assign) Dkit [Off, On]

You can select this only if the specified program is a drum program (**Oscillator Mode Drums**). These settings can also be made in the Insert Effect-Routing1. For more information, please see “Bus Select (IFX/Indiv. Out Assign) Dkit” on page 422.

Bus Select (IFX/Indiv.Out Assign)

[L/R, IFX1...12, 1...4, 1/2...3/4, Off]

For each timbre, these parameters specify the bus to which the program oscillator(s) will be sent. The current settings can also be viewed in the Routing Map. This parameter can also be edited from the IFX– Routing1 page. For more information, please see “Bus Select (IFX/Indiv.Out Assign)” on page 422.

FX Control Bus [Off, 1, 2]

Sends the output of the timbre to an FX Control bus (two-channel stereo FX Ctrl 1 or 2).

Use the FX Control buses when you want a separate sound to control the audio input of an effect. You can use two FX Control buses (each is a two-channel stereo bus) to control effects in various ways.

For more information, please see “FX Control Buses” on page 735.

REC Bus (All OSCs to) [Off, 1...4, 1/2, 3/4]

These settings send the output of the timbre to the REC buses (four mono channels: 1, 2, 3, 4).

The REC buses are dedicated internal buses for recording, used for sampling in the various modes or for recording audio tracks in SEQUENCER mode.

In COMBINATION mode, you can resample your keyboard or Arpeggiator performance, or sample an external audio signal from the Audio Inputs.

Normally you will set **Source Bus** (0–8c) to L/R, so that you can sample the signal of the L/R bus line, such as your keyboard or Arpeggiator performance. However, you can use a REC bus if you want to sample only an audio input while performing on the keyboard or Arpeggiator function which are being output via L and R. If desired, multiple audio inputs can be mixed to a REC bus, or the direct signal from an audio input can be mixed to a REC bus along with the sound from an insert effect and sampled. Alternatively, you can resample the keyboard performance of only specific timbres. For more information, see the diagram “Source Bus = REC Bus 1/2” on page 23.

Off: The signal will not be sent to a REC bus. Normally you will leave this off.

1...4: The output of the timbre will be sent to the corresponding REC bus. The **Pan** setting (0–1b) of each timbre will be ignored, and the signal will be sent in monaural.

1/2, 3/4: The output of the timbre will be sent in stereo to the corresponding pair of REC buses. The signal is sent in stereo to REC buses 1/2 or 3/4 according to the **Pan** setting (0–1b) of each timbre.

Timbre 02...16 (Timbre Number)

These settings specify the program oscillator output bus, effect control bus, and REC bus used by timbres 2 through 16. These are the same as for timbre 1. See “Timbre 01”.

✓ 8-2: Page Menu Commands

- Compare →p.112
- Write Combination →p.433
- Exclusive Solo →p.113
- Copy Insert Effect →p.122
- Swap Insert Effect →p.123
- Drum Kit IFX Patch →p.438
- PAGE →p.126
- MODE →p.126

8-5: Insert FX



8-5a: IFX

Here you can choose the type of each insert effect 1 through 12, its on/off status, chaining, and adjust the post-IFX mixer settings. Meters below the IFX labels display the effect output levels in realtime, showing the combined peak signals of the left and right channels.

For insert effects, the direct sound (Dry) is always stereo-in and out. The input/output configuration of the effect sound (Wet) depends on the effect type.

For detailed explanations of the individual effects, please see the “Effect Guide” on page 731.

The following parameters are the same as in PROGRAM mode. For more information, please see “8-5a: IFX” on page 101.

However, unlike in PROGRAM mode, you can use a different MIDI channel to modulate each effect, if desired. This includes the post-IFX **Pan (CC#8)**, **Send1**, and **Send2** settings, as well as the effect’s dynamic modulation (Dmod). To set the MIDI channel, use the **Ch** parameter on the IFX 1-12 page (8-7a).

IFX1

For detailed information on these parameters, see “8-5a: IFX” on page 101.

- IFX1** [000...197]
- IFX1 On/Off** [Off, On]
- Chain to** [IFX2...IFX12]
- Chain** [Off, On]
- Pan(CC#8) (Post IFX Pan)** [L000...C064...R127]
- Bus Sel. (Bus Select)** [L/R, 1...4, 1/2...3/4, Off]
- Ctrl Bus (FX Control Bus)** [Off, 1, 2]
- REC Bus** [Off, 1...4, 1/2, 3/4]
- Send1** [000...127]
- Send2** [000...127]

IFX2...12

These parameters specify the type of each insert effect, its on/off status, chaining, and post-IFX mixer settings. With the exception of **Chain to** and **Chain**, the parameters are the same as for IFX1. For more information, please see “IFX1” on page 101.

| | |
|------------------------|------------------------|
| IFX2: Chain to | [IFX3...IFX12] |
| IFX3: Chain to | [IFX4...IFX12] |
| IFX4: Chain to | [IFX5...IFX12] |
| IFX5: Chain to | [IFX6...IFX12] |
| IFX6: Chain to | [IFX7...IFX12] |
| IFX7: Chain to | [IFX8...IFX12] |
| IFX8: Chain to | [IFX9...IFX12] |
| IFX9: Chain to | [IFX10...IFX12] |
| IFX10: Chain to | [IFX11...IFX12] |
| IFX11: Chain to | [IFX12] |

✓ 8-5: Page Menu Commands

- Compare →p.112
- Write Combination →p.433
- Exclusive Solo →p.113
- Copy Insert Effect →p.122
- Swap Insert Effect →p.123
- Insert IFX Slot →p.123
- Cut IFX Slot →p.124
- Clean Up IFX Routings →p.124

- PAGE →p.126
- MODE →p.126

8-7: IFX 1-12



This page lets you edit the parameters of the insert effect 1. Use the tabs at left to select IFX1 through IFX12.

Effects Modulation: Dmod

Most effects have one or more parameters which can be modulated in realtime. In the NAUTILUS, this is called Dynamic Modulation, or Dmod for short.

For a complete list of Dmod sources, see “Dynamic Modulation Source List” on page 912.

MIDI You can use different MIDI channels to control Dmod for each effect, if desired, as selected by the **Ch (Control Channel)** parameter.

8-7a: IFX1

IFX Type

This selects the effect type for insert effect 1.

IFX1 On/Off

[Off, On]

Turns the insert effect on/off. This is linked with the on/off setting in the IFX– Insert FX page.

Ch (Control Channel) [Ch01...16, G ch, All Routed]

This parameter specifies the MIDI channel that will be used to control effect dynamic modulation (Dmod), pan following the insert effect (CC#8), Send 1, and Send 2.

The channel number of the timbre routed through this IFX will be followed by a “*” displayed at the right of Ch01–16. If two or timbres with different MIDI channel settings are routed through the same IFX, this parameter specifies which of these channels will be used to control the effect.

G ch: The global **MIDI Channel** (GLOBAL 1–1a) will be used to control the effect. Normally you will set this to G ch.

All Routed: The channel of any timbre routed through this effect can be used to control the effect. (Channels of each routed timbre will be indicated by “*.”)

Drum Kits and the MIDI Control Channel

If a Timbre is using a Drum Kit, and the Timbre’s **Bus Select (IFX/Indiv. Out Assign) DKit** (8–1b) is enabled, this effects the MIDI Control Channel as well. In this case, the Timbre’s MIDI channel will be used to control any effect whose **Ch** is set to All Routed, regardless of the **Bus Select (IFX/Indiv.Out Assign)** (GLOBAL 4–3b) settings or the settings of the **DrumKit IFX Patch** page menu command.

P (Effect Preset) [P00, P01...15, U00...15, -----]

This selects the effect preset.

For more information, please see “Effect preset function” on page 103.

IFX1 Parameters

Set the parameters for the effect type selected for insert effect 1.

For more information, please see “Insert Effects (IFX1...IFX12)” on page 739.

8-7b: IFX2...12

This configures the parameters of insert effects 2–12.

The parameters for IFX2 through IFX12 are the same as for IFX1. For more information, please see “8–7a: IFX1” on page 427.

✓ 8-7: Page Menu commands

- Compare →p.112
- Write Combination →p.433
- Exclusive Solo →p.113
- Copy Insert Effect →p.122
- Swap Insert Effect →p.123
- Write FX Preset →p.126
- PAGE →p.126
- MODE →p.126

8–9: Common FX LFO

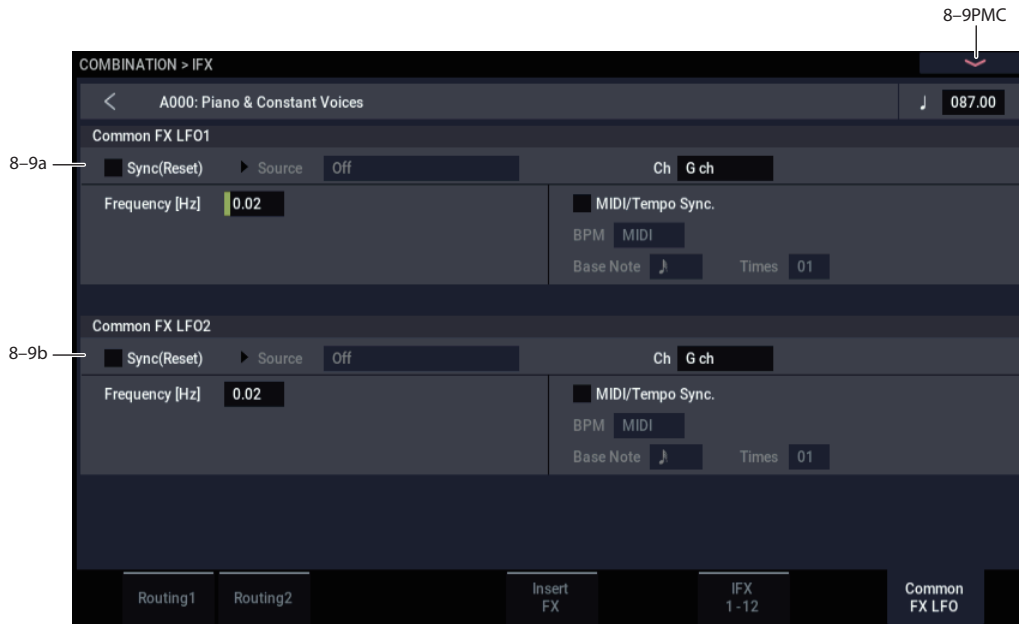

The two Common FX LFOs allow you to synchronize LFO-based modulation for multiple effects, such as phasers, flangers, filters, and so on.

The Common LFOs control only the frequency, MIDI synchronization, and reset options; each individual effect still has its own settings for the LFO waveform and phase.

Within the individual effects, you can choose whether to use one of the Common LFOs, or to use the individual effect's frequency, sync, and/or reset settings instead. This is done via the effect's **LFO Type** parameter; select **Individual** to use the effect's settings, or **Common 1** or **2** to use the Common LFOs.

8–9a: Common FX LFO1

Ch (Control Channel) [Ch01...Ch16, G ch]

Specifies the MIDI channel that will control dynamic modulation (Dmod) for Common LFO 1 and 2.

G ch: The global **MIDI channel** will be used for control. This is the default.

Sync (Reset) [Off, On]

Source (Dmod Source) [List of Dmod Sources]

Frequency [0.02...20.00 Hz]

MIDI/Tempo Sync [Off, On]

BPM [MIDI, 040.00...300.00]

Base Note [♪... ♭]

Times [01...32]

These parameters are the same as in PROGRAM mode. For details, see “8–9a: Common FX LFO1” on page 105.

8–9b: Common FX LFO2

These parameters are the same as for Common FX LFO1. For more information, please see “8–9a: Common FX LFO1” on page 105.

✓ 8–9: Page Menu Commands

- Compare →p.112
- Write Combination →p.433
- Exclusive Solo →p.113
- Copy Insert Effect →p.122
- Swap Insert Effect →p.123
- PAGE →p.126
- MODE →p.126

COMBINATION > MFX/TFX

Here you can make settings for the master effects and total effects. For instance, you can:

- Route a sound to an master effects and total effects

- Make detailed settings for master effects and total effects
- For more information, please see “Effect Guide” on page 731.

9-1: Routing

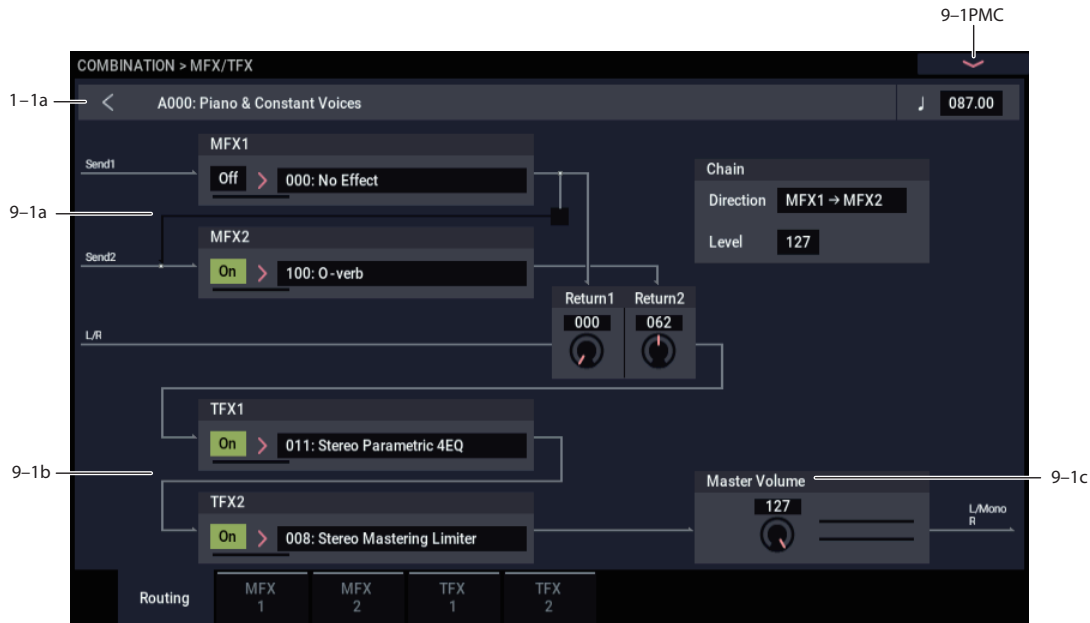

Here you can specify the type of master effects and total effects, and turn them on/off. The meters below the effects names display the effect output levels in realtime, showing the combined peak signals of the left and right channels.

The master effects are sent to the L/R bus. The total effects are inserted into the L/R bus.

9-1a: MFX1, 2

MFX1

MFX1 [000...197]

MFX1 On/Off [Off, On]

Return 1 [000...127]

MFX2

MFX2 [000...197]

MFX2 On/Off [Off, On]

Return 2 [000...127]

Chain

Chain On/Off [Off, On]

Chain Direction [MFX1->MFX2, MFX2->MFX1]

Chain Level [000...127]

These parameters are the same as in PROGRAM mode. For more information, please see “9-1a: MFX1, 2” on page 107.

9-1b: TFX1, 2

TFX1

TFX1 [000...197]

TFX1 On/Off [Off, On]

TFX2

TFX2 [000...197]

TFX2 On/Off [Off, On]

These parameters are the same as in PROGRAM mode. For more information, please see “9-1b: TFX1, 2” on page 108.

9-1c: Master Volume

Master Volume [000...127]

✓ 9-1: Page Menu Commands

- Compare →p.112
- Write Combination →p.433
- Exclusive Solo →p.113
- Copy MFX/TFX →p.125
- Swap MFX/TFX →p.125
- PAGE →p.126
- MODE →p.126

9-2: MFX1



Here you can edit the parameters of the master effect 1.

Effects Modulation: Dmod

Most effects have one or more parameters which can be modulated in realtime. In the NAUTILUS, this is called Dynamic Modulation, or Dmod for short.

For a complete list of Dmod sources, see “Dynamic Modulation Source List” on page 912.

MIDI You can use different MIDI channels to control Dmod for each effect, if desired, as selected by the **Ch (Control Channel)** parameter.

9-2a: MFX1

MFX1 On/Off [Off, On]

This turns master effect 1 on/off. This is linked with the on/off setting in the MFX/TFX– Routing page.

Ch (Control Channel) [Ch01...16, G ch]

Specifies the MIDI channel that will control dynamic modulation (Dmod) for the master effect.

Ch01...Ch16: The specified MIDI channel will be used for control.

G ch: The global **MIDI Channel** (GLOBAL 1–1a) will be used for control. Normally you will use the G ch setting.

P (Effect Preset) [P00, P01...15, U00...15, -----]

This selects the effect preset.

For more information, please see “Effect preset function” on page 103.

MFX1 Parameters

Here you can set the effect type parameters selected in the master effect 1.

For details on the master effects, please see the “Effect Guide” on page 731.

✓ **9-2: Page Menu Commands**

- Compare →p.112
- Write Combination →p.433
- Exclusive Solo →p.113
- Copy MFX/TFX →p.125
- Swap MFX/TFX →p.125
- Write FX Preset →p.126
- PAGE →p.126
- MODE →p.126

9-3: MFX2

9-4: TFX1

9-5: TFX2

These pages let you edit the parameters of Master Effect 2 and Total Effects 1 and 2.

The parameters of MFX2, TFX1, and TFX2 are the same as for MFX1. For more information, please see “9-2: MFX1” on page 431.

COMBINATION: Page Menu Commands

| | |
|--|--------|
| Compare | →p.112 |
| Write Combination | →p.433 |
| Exclusive Solo | →p.113 |
| Copy From Program | →p.433 |
| Add To Set List | →p.113 |
| Load required samples | →p.114 |
| Edit Program | →p.434 |
| Initialize Combination | →p.435 |
| Optimize RAM | →p.114 |
| Select Sample No. | →p.115 |
| Select Directory/File for Sample To Disk | →p.115 |
| Auto Sampling Setup | →p.116 |
| Copy Tone Adjust | →p.436 |
| Reset Tone Adjust | →p.436 |
| Show EQ Graphic | →p.436 |
| Copy X-Y Envelope | →p.119 |
| Detune BPM Adjust | →p.437 |
| Copy External Scene | →p.122 |
| Copy Scene | →p.122 |
| Swap Scene | →p.122 |
| Initialize Scene | →p.122 |
| Copy Insert Effect | →p.122 |
| Swap Insert Effect | →p.123 |
| Insert IFX Slot | →p.123 |
| Clean Up IFX Routings | →p.124 |
| Drum Kit IFX Patch | →p.438 |
| Copy MFX/TFX | →p.125 |
| Swap MFX/TFX | →p.125 |
| Write FX Preset | →p.126 |
| PAGE | →p.126 |
| MODE | →p.126 |

Write Combination

This command writes an edited Combination into the NAUTILUS internal memory. It is available on every page in COMBINATION mode.

This lets you:

- Save your edits
- Rename the Combination
- Assign the Combination to a Category
- Mark the Combination as a Favorite
- Copy the Combination to a different Bank and number

Be sure to **Write** any Combination that you wish to save. An edited Combination cannot be recovered if you do not write it before turning off the power or selecting another Combination.

- ⚠ Do not turn off the power for at least 10 seconds after using the **Write Combination** command. This allows the system time to complete the process, which includes saving a backup of the data to the internal drive.

For more information, please see “Write Program” on page 112.

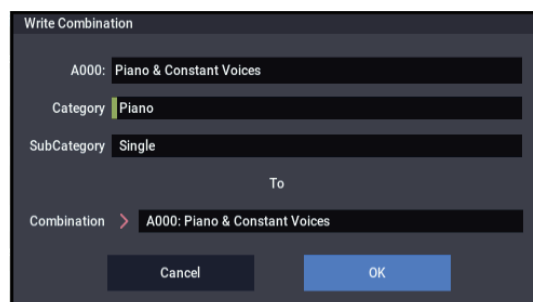

If you use “Category” or “Sub Category” to specify a category for the combination you are writing, you will be able to select that combination by its category or sub category in COMBINATION > Home.

The names of the combination categories can be edited in “Combi Category” (GLOBAL 3–2).

Exclusive Solo

This command is available on every page in COMBINATION mode. When **Exclusive Solo** is **On**, only one Timbre is soloed at a time; when it is **Off**, multiple Timbres can be soloed together.

For more information, please see “Exclusive Solo” on page 113.

Copy From Program

This command is available on every page in COMBINATION mode. It copies Effects and/or ARP settings from a selected Program to the current Combination. This lets the Program sound the same as it did in PROGRAM mode.

1. Select “Copy From Program” to open the dialog box.

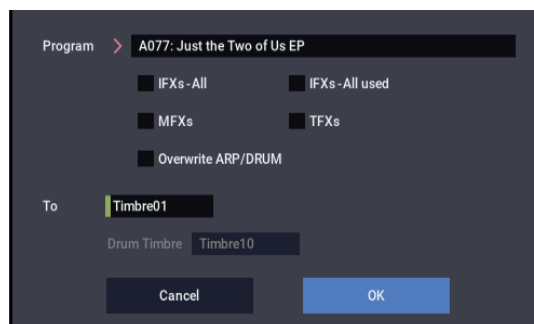

2. Use “Program” to select the copy-source program.
3. Select the IFX-All, IFX-All used, MFXs, and TFXs options to specify which, if any, of the Program’s effects settings to copy.

IFX-All: The settings of all insert effect settings (the contents of the Insert FX page and the IFX1–12 effect parameters) of the copy-source program will be copied.

IFX-All used: Only the insert effects used by the copy-source program will be copied. The copied settings will be packed into vacant slots (i.e., slots with 000: No Effect, unless such slots are located inside the chain).

Note: Copy-source insert effects set to 000: No Effect will not be copied. However, if 000: No Effect is located inside the chain, it will be copied.

MFxs: All master effect settings of the copy-source program will be copied.

TFxs: All total effect settings of the copy-source program will be copied.

About the Bus Select (8–1b, 8–2a, 8–5a) setting

- Regardless of the **IFX-All**, **IFX-All used**, **MFxs**, and **TFxs** settings, will be set to DKit if the copy-source program’s “Use DKit Setting” is checked. In conjunction with this, the “Drum Kit IFX Patch” setting will be reset to the default setting.
 - If **IFX-All** is checked, the **Bus Select** setting of the copy-source program will be copied. If the copy-destination timbre **Bus Select** was set to IFX1–IFX12, it will automatically be set to L/R. If you check **IFX-All used**, the routing will be automatically set to match the copy-source program.
 - If **IFX-All** and **IFX-All used** is unchecked, then the copy-source **Bus Select** setting will be ignored. or if the **Bus Select** of the copy-source program and copy-destination timbre is set to IFX1–IFX12, it will automatically be set to L/R.
- 4. When “Overwrite ARP/DRUM” is selected, the ARP/DRUM settings for the copy source will also be copied.**

When on (selected), the ARP/DRUM settings of the copy source program will be overwritten with the current ARP/DRUM settings.

In COMBINATION mode, the “Output Ch” for each arpeggiator will be set to the MIDI channel of the timbre configured in step 5, and “Thru By ARP Switch Off” will be set to “On” (selected).

Also, the drum program settings for the copy source program will be copied to the “Drum Timbre” set in step 6.

The MIDI channel that is set in the timbre of the drum program’s copy destination will be used.

- 5. Use “To” to set the timbre for the copy destination. The parameters for each timbre will be initialized. The copy source program will be set for “Program” (0–1b “Timbre Program Select”).**
- The “MIDI Channel” (2–1a) settings will not change even though “Overwrite ARP/DRUM” is selected. If “Overwrite ARP/DRUM” is cleared, the MIDI channel will be set to “Gch”.
 - The “Status” (2-1a) setting is automatically set to “INT”.
 - The “P1– Set Up Controllers” setting for the copy source program will be copied.
- 6. Use “Drum Timbre” to set the timbre of the copy destination of the drum program.**
- 7. Press the OK button to copy, or press the Cancel button if you decide not to copy.**

Edit Program

This command, available on the Home– Mixer page in COMBINATION mode and the Home– Mixer page in SEQUENCER mode, allows you to edit a Program from within a Combination or Song, while still hearing all of the other Timbres or Tracks.

To do so:

- 1. Go to the Home– Mixer page in COMBINATION mode, or the Home– Mixer page in SEQUENCER mode.**

To edit a Program in context, either:

- 2. Select any parameter in the column of the Timbre or Track which contains the Program you’d like to edit, and then select the Edit Program command from the menu.**

You can select any parameter in the Timbre/Track’s column, including Volume, Pan, Status (Combinations only), and Program Bank/Number.

or:

- 2a. Hold the ENTER button, and then touch the Program’s name in the Timbre or Track.**

The display will automatically switch to the Home page for the program at this time, and either “COMBINATION > PROGRAM > Home” or “SEQUENCER > PROGRAM > Home” will be displayed at the upper left. This means that the program is being edited in COMBINATION or SEQUENCER mode.

- 3. Edit as desired.**

Eventually, if you want to keep your changes, you’ll need to Write the Program. However, while you’re working, you can go back and forth between the edited Program and the Combination or Song.

You’ll notice that some Program pages and tabs will be grayed out; for more information, see “Parameters unavailable while editing in context,” below.

To return to the Combination or Song:

- 4. Press the EXIT button until the PROGRAM > Home– Overview Mix Balance page appears, and then press EXIT once again.**

To go back to editing the Program, just repeat steps 2 or 2a, above.

The normal rules of editing apply: if you select another Program, all edits to the previous Program will be lost. So, make sure to save your work:

- 5. While on the Program edit pages, use the Write menu command to save your edits.**

Note that you must be on the Program edit pages in order to Write the Program edits. Writing the Combination or Song will not affect the Program.

If you Write the Program to different bank/number, the Combination Timbre or Song Track selected in step 2 or 2a, above, will be updated to reference the new location. In this case, if other Timbres or Tracks use the Program, they will not be updated automatically (since you may want them to continue to play the original Program); you can change them manually if desired.

Parameters unavailable while editing in context

When editing a Program in context, you'll hear the Combination or Song's effects, EQ, ARP, and Drum Track. Because of this, related pages, tabs, parameters, and functions within the Program will be unavailable, including:

- Home page: 3 Band EQ, Mute(DrumT) button, Drum Track Volume slider
- Home page: ARP/DRUM tab
- Home page: Sampling tab
- Basic/X-Y/Controllers page: Controllers tab
- <EXi> Program Basic page: EXi1 Instrument Type, EXi2 Instrument Type
- EQ page, IFX page, MFX/TFX page
- Tempo

Playing the Program during editing, from the keyboard and MIDI

While editing a Program in context, input from the keyboard and MIDI continues to play the Combination or Song exactly as it did before. For instance, MIDI Channels, Key and Velocity Zones, Solo and Mute, etc. continue to apply. This is important, since it lets you hear the Program exactly as it will play in the finished Combination or Song.

Note that this means that if the local keyboard does not play the selected PROGRAM in COMBINATION or SEQUENCER modes (for instance, if you're in a Combi and the Timbre is not on the Global MIDI Channel), then the keyboard will still not play the Program during editing. If the sound is being played by other means—for example, from the NAUTILUS sequencer, ARP, or an external DAW or MIDI controller—then this may not matter. If necessary, you can use various means to route the keyboard to the Program, such as:

- Use MIDI Thru on an external DAW
- In SEQUENCER mode, set the Keyboard Track to play the desired Track
- In COMBINATION mode, temporarily change the Timbre/Track's MIDI channel, and/or adjust Key or Velocity zones

Of course, if you want to edit the Program by itself, unaffected by the context of the Combination or Song, simply go to PROGRAM mode and edit the sound there!

Initialize Combination

Initialize Combination is available on the Home page. This command restores all Combination settings to their defaults, so that you can start with a clean slate. Note that any edits you've made to the Combination will be lost.

You can either initialize the current Combination only, or all Combinations in the current bank.

To initialize only the current Combination:

1. Select the “Initialize Combination” menu command.

The Initialize Combination dialog box will appear.

By default, the **All Combinations in the current bank** check-box will be disabled (un-checked). Leave it that way.

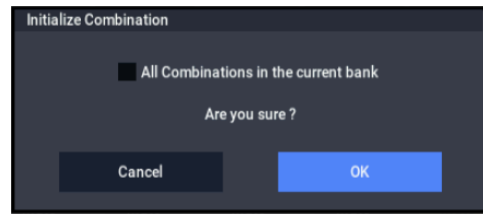

2. Press OK.

The Combination's edit buffer will be initialized, restored to default values. Note that in this case the stored data is not affected. If you want to keep the initialized Combination, you'll need to use the **Write** command.

To initialize all Combinations in the current bank:

1. Select the “Initialize Combination” menu command.

The Initialize Combination dialog box will appear.

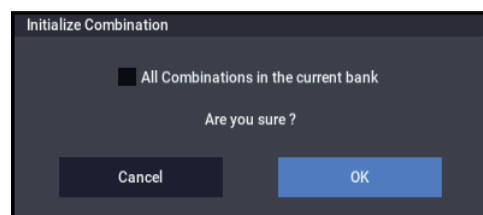

2. Enable the check-box for “All Combinations in the current bank.”

With this option enabled, all Combinations in the bank will be initialized, including the stored version of the current Combination.

Optimize RAM

Optimize RAM is available on the Audio In/Sampling tab of the Play page. This command reorganizes unused space in RAM, allowing the full amount of remaining memory to be used.

For more information, please see “Optimize RAM” on page 114.

Select Sample No.

Select Sample No. is available on the Audio In/Sampling tab of the Play page.

This specifies the sample number into which the sampled data will be written. You can also specify whether the sample will automatically be converted to a program after sampling. **Select Sample No.** can be selected if you have selected RAM as the “Save to” destination.

For more information, please see “Select Sample No.” on page 115.

Select Directory/File for Sample to Disk

This command is available on the Audio In/Sampling tab of the Play page, when the sampling **Save To** parameter is set to DISK.

When sampling to drive, this lets you set the drive, directory, and file name for the resulting WAVE file.

For more information, please see “Select Directory/File for Sample To Disk” on page 115.

Auto Sampling Setup

Auto Sampling Setup is available on the Audio In/Sampling tab of the Play page.

This command automatically sets sampling-related parameters in COMBINATION mode. This is a helpful convenience when you're resampling your performance on a combination, or when you're using a combination as a guide while sampling an external source. You can also use this command to initialize the settings.

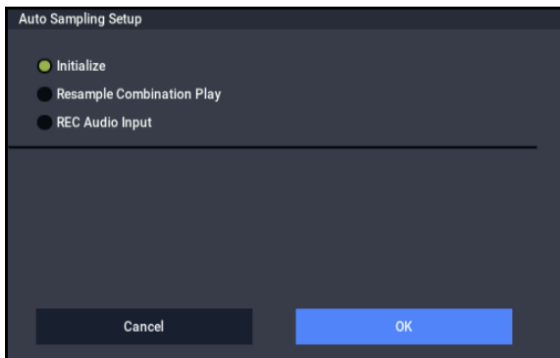

- **Initialize:** Sets sampling-related parameters to their default state.
- **Resample Combination Play:** Makes settings so you can play a combination and resample your performance.
- **REC Audio Input:** Makes settings so you can sample an external audio source while listening to yourself play a combination.

For more information, please see “Auto Sampling Setup” on page 116.

Copy Tone Adjust

Copy Tone Adjust is available when CONTROL ASSIGN is set to **Tone Adjust**.

This command replaces the Tone Adjust settings of the selected Timbre (COMBINATION mode) or Track (SEQUENCER mode) with those of any other Program, Timbre, or Track.

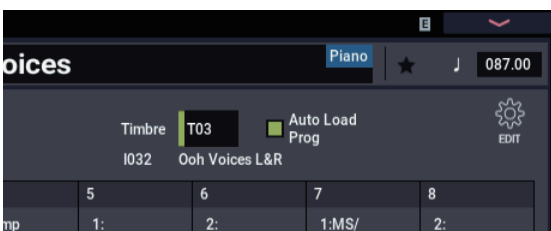

1. Select “Copy Tone Adjust” to open the dialog box.

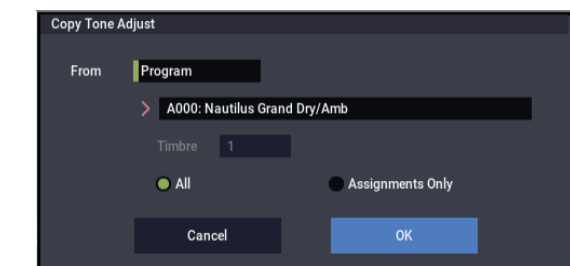

2. Use From to select the Program, Combination, or Song from which to copy.

3. If you've selected a Combination or Song, select a specific Timbre or Track as well.
4. Choose either **All** or **Assignments Only** to select the **Tone Adjust** parameters that you want to copy.
 - All:** Copies all of the Tone Adjust parameters and their values assigned to the switches and sliders.
 - Assignments Only:** Copies only the parameters assigned to the switches and sliders. Values will not be copied.
5. To execute the **Copy Tone Adjust** command, press the **OK** button. To exit without copying the controls, press the **Cancel** button.

Reset Tone Adjust

Reset Tone Adjust is available when CONTROL ASSIGN is set to **Tone Adjust**.

This command affects only the selected Timbre or Track, as opposed to the entire Combination or Song. It resets the Tone Adjust settings to their default values.

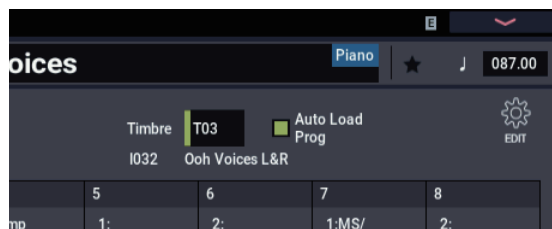

1. Select “Reset Tone Adjust” to open the dialog box.

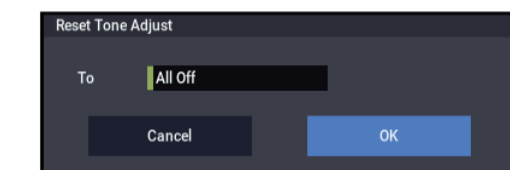

2. Use the “To” field to specify how the Tone Adjust parameters will be reset.
 - All Off:** All parameters will be reset to Off.
 - Default Setting:** The parameters will be reset to the default settings for the corresponding program type (HD-1, AL-1, CX-3).
3. To execute the **Reset Tone Adjust** command, press the **OK** button. To exit without resetting the controls, press the **Cancel** button.

Show EQ Graphic

Show EQ Graphic is available on the Timbre EQ tab of the EQ/X-Y/Controllers page.

This command calls up a floating window, showing a graphic representation of the selected Timbre's EQ settings. You can leave the window open as you work; as you change EQ settings, or select different Timbres, the graphic will update accordingly.

The window will cover the parameters for some of the Timbres on either the right or left sides of the display. If you select one of these Timbres, the window will automatically move to the other side of the display.

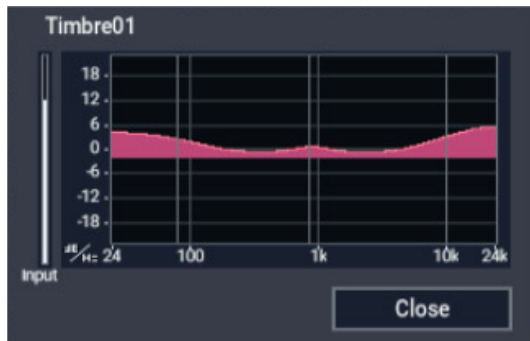

Copy X-Y Envelope

Copy X-Y Envelope is available on the X-Y Envelope tab of the EQ/X-Y/Controllers page.

This command copies the X-Y envelope from a specified program, combination/timbre, or song. For more information, see “Copy X-Y Envelope” on page 119.

Detune BPM Adjust

Detune BPM Adjust is available on the Pitch tab of the Timbre Parameters page.

This command changes a loop’s tempo by changing the Timbre’s **Detune** parameter. The sample data itself is not altered. Since this alters the pitch of the loop along with the tempo, it’s generally suited only to un-pitched percussive loops.

Note: Using **Detune BPM Adjust** will over-write any previous **Detune** settings.

1. Go to the Pitch tab of the Timbre Parameters page.
2. Select the Detune parameter for the desired Timbre.

Detune BPM Adjust is available only when the **Detune** parameter has been selected. Otherwise, the menu selection will be grayed out.

3. Select “Detune BPM Adjust” to open the dialog box.

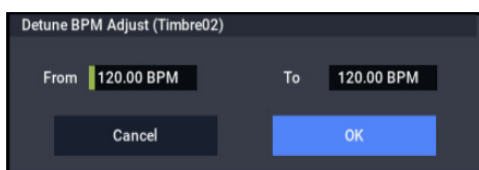

4. In **From**, specify the loop’s original BPM value.

Ignore any previous changes from using Detune BPM adjust.

5. In **To**, specify the desired BPM value.

The appropriate **Detune** value will be calculated automatically from these two values.

For example, if you set “From” to 60 bpm and “To” to 120 bpm, **Detune** will be set to +1200 (one octave up).

6. To execute the **Detune BPM Adjust** command, press the **OK** button. To exit without changing the **Detune** value, press the **Cancel** button.

Note: Since this command does not affect the sample data itself, and always over-writes the previous **Detune** amount, using it repeatedly has no cumulative effect.

Copy External Scene

Please see “Copy External Scene” on page 122.

Copy Scene

Please see “Copy Scene” on page 122.

Swap Scene

Please see “Swap Scene” on page 122.

Copy Insert Effect

This command copies effects settings from Program, Combination, Song, or SAMPLING modes. For more information, please see “Copy Insert Effect” on page 122.

Note: The slot’s MIDI control channel, as specified by the **Ch** parameter on the IFX1–12 pages, will not be copied.

Swap Insert Effect

This command swaps (exchanges) insert effect settings. For more information, please see “Swap Insert Effect” on page 123.

Note: The slot’s MIDI control channel, as specified by the **Ch** parameter on the IFX– IFX1-12 pages, will not be swapped.

Insert IFX Slot

For more information, please see “Insert IFX Slot” on page 123.

Cut IFX Slot

For more information, please see “Cut IFX Slot” on page 124.

Clean Up IFX Routings

For more information, please see “Clean Up IFX Routings” on page 124.

Drum Kit IFX Patch

This patches the **Bus Select** settings for each key of a drum kit, temporarily changing the insert effect connection destinations. You can execute this only if the timbre's program is a drum program, "DKit" is checked, and the **Bus Select (IFX/Indiv.Out Assign)** (GLOBAL 4–3b) setting of the keys in the drum kit is set to either IFX1–12.

1. In the **Routing1** page or **Routing2** page, select the timbre for which you want to make settings. (Select a timbre parameter or Timbre Number.)



2. Select **Drum Kit IFX Patch** to open the dialog box.

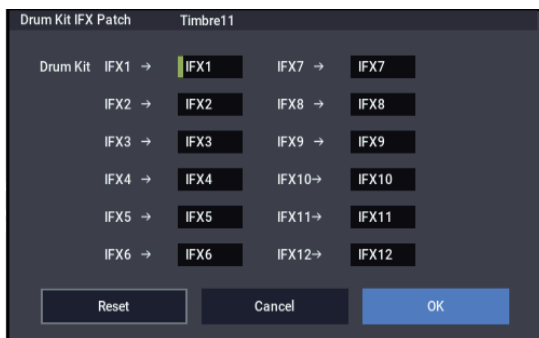

3. In the DrumKit "IFX" popup, select the output bus to which you want to patch the signal: an insert effect or L/R, 1–4, 1/2–3/4, or Off.
4. To execute the Drum Kit Insert Effect Patch command, press the OK button. To cancel, press the Cancel button.

Note: To restore the condition of the drum kit, execute IFX1→IFX1, IFX2→IFX2, IFX3→IFX3, IFX4→IFX4, IFX5→IFX5, IFX6→IFX6, IFX7→IFX7, IFX8→IFX8, IFX9→IFX9, IFX10→IFX10, IFX11→IFX11, and IFX12→IFX12.

Alternatively, you can press the **Reset** button to restore the same settings.

Copy MFX/TFX

This command copies effect settings from PROGRAM, COMBINATION, SEQUENCER, or SAMPLING modes. For more information, please see "Copy MFX/TFX" on page 125.

Note: The slot's MIDI control channel, as specified by the **Ch** parameter on the MFX/TFX– MFX 1-2 and TFX 1-2 pages, will not be copied.

Swap MFX/TFX

This command swaps (exchanges) insert effect settings. For more information, please see "Swap MFX/TFX" on page 125.

Note: The slot's MIDI control channel, as specified by the **Ch** parameter on the MFX/TFX– MFX 1-2 and TFX 1-2 pages, will not be copied.

Write FX Preset

For more information, please see "Write FX Preset" on page 126.

SEQUENCER mode

Sequencer Overview

The NAUTILUS contains a sophisticated sequencer that integrates a 16-track MIDI sequencer with a 16-track internal drive recorder.

The sixteen MIDI tracks and the master track (which contains tempo data, etc.) allow you to record and play back MIDI data for the internal tone generator or for external sound modules, and the sixteen audio tracks allow you to record and play back audio signals on the internal drive recorder in synchronization with the MIDI tracks. You can use the audio tracks to record external audio sources such as guitar or vocals as well as the sound produced by the internal tone generator. You can also automate parameters such as volume and pan.

The In-Track Sampling function, Time Stretch/Slice function, Arpeggiator function, the sophisticated effects, controllers, and the numerous other functions of the NAUTILUS can be used together to give you a wide range of possibilities for music production or live performance.

Template Songs

Template Songs store pretty much everything in the Song except for the MIDI and audio data itself. This includes Program selections, track parameters, effects and Arpeggiator settings, and the Song's name and tempo.

The factory preset Template Songs let you get up and running quickly with matched sets of sounds and effects for various styles of music. You can also create your own Template Songs with your favorite sounds and setups.

Note that Template Songs do not include the MIDI data for song tracks and patterns, audio data, or settings that govern how the musical data is played back, including **Meter**, **Metronome**, **PLAY/MUTE**, and **Track Play Loop** (including Start/End measure).

While loading a Template Song, you can also optionally load one or more Drum Track patterns.

For more information, please see "Template Songs" on page 78 of the OG.

Important notes about SEQUENCER mode

- 🔧 To save the program, track parameters, effects, arpeggiator function settings and so on that are selected in the song as a template song, use the "Save Template Song" page menu command.
- 🔧 When you create audio tracks, we recommend that you save them on the internal drive, since audio tracks can be recorded and played back only on the internal drive.
- 🔧 To record audio tracks, **MIDI Clock** must be set to **Internal**. For more information, see "MIDI Clock (MIDI Clock Source)" on page 653.

MIDI sequencer

- The sequencer lets you record a maximum of 400,000 MIDI events (or 300,000 audio events), up to 200 songs, and as many as 999 measures per song.
- Timing resolution is a maximum of $\frac{1}{480}$.
- There are sixteen tracks for MIDI performance data, and a master track that controls the time signature and tempo.
- Arpeggiator can be used during playback or recording.
- The RPPR (Realtime Pattern Play/Recording) function can be used during playback or recording.
- Eighteen different Template Songs are built-in, and contain program and effect settings suitable for various musical styles. You can create up to sixteen original templates, and save them as user Template Songs.
- A track play loop function lets you loop specified measures independently for each track.
- A large number of preset patterns ideal for drum tracks are built in. In addition, you can create up to 100 user patterns for each song. These patterns can be used as musical data within a song, or can be played by the RPPR function.

MIDI recording features

- Various methods of recording are supported, including realtime recording in which your performance on the keyboard and controllers (including MIDI control events) is recorded just as you play, and step recording in which the timing, length, and velocity of each note can be specified in the LCD as you input the pitches from the keyboard.
- The musical data and control events that you recorded can be edited in various ways (including event editing and many other edit commands).
- MIDI System Exclusive (SysEx) messages can be recorded and played back. SysEx messages received from an external MIDI device or parameter changes produced by editing track parameters or effect parameters can be recorded in real-time on any desired track.

Parameter-related features

- When the **Status** of a track is set to INT or Both, an external sequencer can be used to play NAUTILUS as a multi-timbral tone generator. When the **Status** of a track is set to Both, EXT, or EX2, the sequencer of NAUTILUS can play external tone generators.
- Tone Adjust parameters let you make temporary adjustments to the sound of the program used by a track, while leaving the original program unchanged. While creating a song, you can use this capability to make changes in realtime by (for example) softening the tone of the bass sound or sharpening the attack of the strings without having to return to PROGRAM mode and edit the program itself.
- NAUTILUS's AMS (Alternate Modulation) capability lets you use control changes for realtime control of the parameters of the programs used in a program. Its MIDI Sync abilities let you synchronize the LFO speed to changes in the tempo.
- Dmod (Dynamic Modulation) functionality lets you control effect parameters in realtime. You can also use MIDI Sync to synchronize the LFO speed or delay time to changes in the tempo.

Editing and operation features

- The Edit Program feature allows you to adjust Program parameters while a Song is playing, and while still hearing all of the other Tracks.
- Program and Combination settings can be copied to a song.
- Sequencer data such as a song that you create can be saved in NAUTILUS's native format, or transmitted as a MIDI data dump.
- A song you created can be converted into SMF (Standard MIDI File) data. SMF songs can also be loaded.
- The **Play/Rec/Mute** and **Solo** buttons let you instantly play/mute any desired track on the fly.
- You can rewind or fast-forward MIDI Tracks while listening to the sound.

Sampling features

- Multisamples you create can be played back together with internal programs in SEQUENCER mode. The Time Slice function of SAMPLING mode lets you divide a rhythm loop sample and create performance data that corresponds to the divided samples. In SEQUENCER mode you can play this performance data, and adjust the playback tempo without affecting the pitch of the rhythm loop sample. You can also exchange the note numbers of the data, or modify the timing to freely re-create new rhythm loops.
- The NAUTILUS provides an In-Track Sampling function which lets you sample an external audio source while the song plays back, and will automatically create note data to trigger that sample at the appropriate point during the playback of the track.

Drive recorder section

- You can use up to 300,000 audio events (or 400,000 MIDI events), up to 200 songs, and up to 999 measures per song.
- Sixteen audio tracks are provided. Each track provides linear 16-bit PCM recording, with a maximum length of 80 minutes for one recorded take.
- Automation data (volume, pan, EQ, send 1/2) can be recorded for each track.
- Sixteen tracks can be played back simultaneously, and four tracks can be recorded simultaneously.
- The Stereo Pair function lets you control two adjacent tracks by adjusting just the odd-numbered track. This lets you simultaneously make mixer settings for a pair of stereo-recorded tracks.
- A broad range of internal buses can be selected as the recording source: Audio Inputs 1–2, USB, L/R, REC Bus 1–4, or Individual 1–4. Flexible routing even lets you insert effects into external audio sources and record them.
- When you realtime-record, an audio event and region data are created. The region data is linked with the WAVE data (audio data) recorded on the drive. You are free to edit this data in a variety of ways, such as moving the location of the audio event, or editing/replacing the region data or WAVE file.
- You can use numerous editing commands (including event editing) to edit the recorded audio events. Event editing lets you edit the time stamp or region data of the audio events.
- Region editing lets you edit the WAVE file selection, and adjust the start/end addresses of the WAVE file in units of a single sample.
- You can freely select a region of a WAVE file (mono, 48 kHz sample rate) and use it in your song. You can use commercially available sample data etc. in your song by sample-rate converting it from 44.1 kHz into 48 kHz. WAVE files editing operations such as Volume Ramp and Normalize are also provided.
- The Time Stretch function lets you stretch or shrink the tempo of a phrase you recorded or a sample you assigned, making it match the tempo of your song.
- The convenient Anchor function makes it easy to place a phrase at the correct timing in your song.
- Auto and manual punch-in/out are provided.
- The Rehearsal function lets you practice punch-in/punch-out recording without actually recording anything.

Common section

- As the MIDI clock master, you can choose either Internal, External or Auto, letting you synchronize the NAUTILUS with other MIDI equipment.
- For each song, three-band EQ is provided on each MIDI track and each audio track.

- For each song, you can use twelve stereo insert effects, two stereo master effects, and two stereo total effects.
- When you've created songs, you can resample them to drive to create WAVE files.
- In addition to the song name, you can assign names to each pattern, track, and region.
- You can use the LOCATE button to move immediately to the desired location.

Setup parameters & Musical data

Each song consists of MIDI tracks 1–16, a master track, audio tracks 1–16, various song parameters such as the song name, settings for the vector function, settings for Arpeggiator, effect settings, RPPR parameters, and 100 user patterns.

Up to 200 such songs can be created in the NAUTILUS.

MIDI tracks 1–16 and audio tracks 1–16 each consist of “track parameters” that specify the starting state of the track, and “playback data.” The master track consists of tempo and time signature data.

- For details on Control Change messages and RPN, see “NAUTILUS and MIDI CCs” on page 923, and “Using RPN (Registered Parameter Numbers)” on page 935.
- For details on MIDI System Exclusive messages, see “System Exclusive events supported in Sequencer mode” on page 557.

MIDI tracks 1–16

Setup parameters

Bank/Program No.*, Play/Rec/Mute, Pan*, Volume*

Track Play Loop, Loop Start Measure, Loop End Measure, Play Intro, EQ (Bypass, Low Gain, Mid Frequency, Mid Gain, High Gain) Status, MIDI Channel, Bank Select (When Status=EX2), Track Priority, Force OSC Mode, OSC Select, Portamento*, Transpose**, Detune**, Bend Range**, Use Program's Scale, Delay (Mode, Time, Base Note, Times), Wave Sequence (Key Sync, Swing, Quantize Trigger), ARP Track On/Off Control, MIDI Filter, Key Zone, Velocity Zone, Track Name, IFX/Indiv.Out Bus, FX Control Bus, Rec Bus, Send1(MFX1)*, Send2(MFX2)*, DKit, Drum Kit IFX Patch

* and **: see “Automating MIDI setup parameters,” below.

Musical data

Note On/Off
 Program Change (including Bank Select)
 Pitch Bend
 After Touch (and Poly Aftertouch)
 Control Change
 Pattern No.
 Exclusive Messages (SysEx)

Automating MIDI setup parameters

Most of the setup parameters can be automated simply by changing them while recording into a MIDI track in real-time. Changing the parameter sends a MIDI message, and when that MIDI message is played back, the parameter changes accordingly.

Setup parameters marked with a single asterisk * transmit and receive specific MIDI messages, such as CCs.

Setup parameters marked with two asterisks ** respond to MIDI RPN messages, and also send and receive MIDI System Exclusive messages.

The other setup parameters transmit and respond to MIDI System Exclusive messages.

Master track

Setup parameters/Musical data

Time signature, Tempo

Both Time signature and Tempo can be automated, simply by changing them in real-time during recording. Any changes are recorded into the Master Track.

Audio tracks

Setup parameters

Rec Source, Play/Rec/Mute***, Pan***, Volume***
 EQ (Bypass***, Low Gain***, Mid Frequency***, Mid Gain***, High Gain***), Delay (Mode, Time, Base Note, Times), Track Name, IFX/Indiv.Out Bus, FX Control Bus, Rec Bus, Send1(MFX1)***, Send2(MFX2)***

Musical data

Audio events
 Automation events

Automating Audio setup parameters

All of the Audio setup parameters can be automated simply by changing them while recording in real-time. Some use audio automation data, while others use MIDI System Exclusive messages.

Setup parameters marked with three asterisks *** generate and respond to audio automation data. You can record changes to these parameters into audio tracks, in real-time.

The other setup parameters transmit and respond to MIDI System Exclusive messages. You can adjust these parameters during realtime recording, and record the resulting MIDI System Exclusive messages into a MIDI track.

WAVE files, regions, and audio events

The data recorded on an audio track consists of a WAVE file, a “region” containing information specifying the section of the WAVE file that will actually be played, and an “audio event” containing data that specifies the locations in the song at which that region will start and stop.

You should be aware that audio events and regions can be deleted by event editing or region editing commands, and can also be lost by turning off the power before saving them to the internal drive. If only the WAVE file is left, leaving the WAVE file on the internal drive will unnecessarily occupy space, so we recommend that you execute the MEDIA–Utility page menu command “Delete Unused WAV Files” to delete such files. For more information, see “Delete Unused WAV Files” on page 727.

If you power-off without deleting these WAVE files, a dialog box with the following message will appear the next time you power-on, asking you whether you want to delete these WAVE files or keep them:

/TEMP folder detected.

This folder may contain unsaved WAVE files from a previous audio track recording session.

Do you want to restore the /TEMP folder, or delete it from the drive?

[Restore] [Delete]

If you want to delete the files, press the Delete button. If you intend to use them in the future, for example in a new song, press the Restore button to keep them. We recommend that you delete unused WAVE files so that space on the internal drive is not occupied unnecessarily.

SEQUENCER > Home

0-1: Mixer

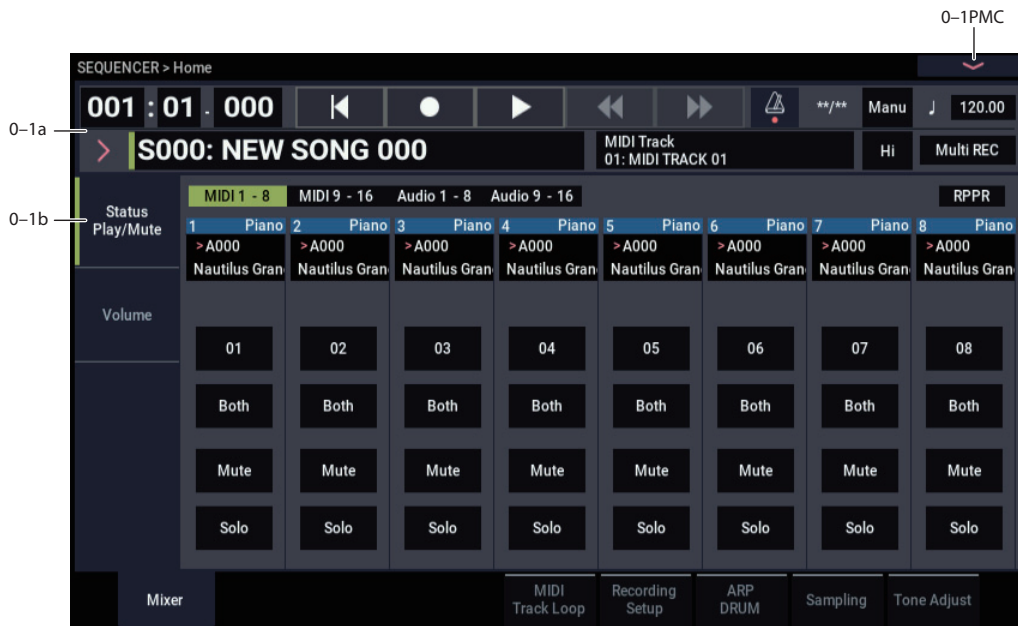

Here you can make basic settings for MIDI track recording and playing back in the song, and can select the program that will be used by each track.

0-1a: Location, Song/Track Select

Location [001:01.000...999:16.479]

This display shows the current position in the song.

From the left, the numbers are the measure (001-999), beat (01-16), and clock (000-479). When you modify these values, the current location will change.

MIDI When **MIDI Clock** (GLOBAL 1-1a) is set to **Internal** (or **Auto**, if no MIDI clocks are being received), the NAUTILUS will transmit Song Position Pointer messages when the **Location** is changed.

Also, if the **MIDI Clock** parameter is set to **External MIDI** (or **Auto**, if MIDI clocks are currently being received), and **Receive Ext. Realtime Commands** (GLOBAL 1-1a) is on, the **Location** will change in response to received Song Position Pointer messages.

 The range in which the beat and clock can be modified will depend on the currently specified time signature.

Transport

SEQUENCER LOCATE button

Press the LOCATE button to go to the location that you set. The factory default location is 001:01.000.

Use the “Set Location” page menu command to change the location.

For more information, see “Set Location (for Locate Key)” on page 523.

If you have reselected a song, the “LOCATE” setting will automatically go to “001:01.000”.

SEQUENCER START/STOP button

Press this button once to play back a song, and press it again to stop. Press the button once more to continue playing from the place where you previously stopped.

SEQUENCER REC button

Press this button to enter record-ready mode. Once you’re in record-ready mode, you can begin recording by pressing the SEQUENCER START/STOP button.

SEQUENCER REW button

SEQUENCER FF button

You can use the <<REW, FF>> buttons while a song is playing or paused. These buttons cannot be used while the sequencer is recording or while a song is stopped.

Use the “FF/REW Speed” settings in the page menu command to set the rewind or fast-forward speeds.

Metronome [Only REC, REC & Play, Off]

Only REC: The metronome will sound only during recording.

REC & Play: The metronome will sound during recording and playback.

Off: The metronome will not sound. However, the pre-count will sound before recording begins.

Meter [*/, 1/4...16/4, 1/8...16/8, 1/16...16/16]**

This is the time signature at the current location of the song. The time signature can be changed at each measure.

***/**:** This will be displayed when you press the SEQUENCER REC button. Specify this when you wish to use the time signature that is already recorded for that measure, and wish to record without changing the time signature.

1/4–16/4, 1/8–16/8, 1/16–16/16: This is the time signature at the current location of the song.

Set **Track Select** to a MIDI Track 01–16, or Audio Track 01–16 press the SEQUENCER REC button, and specify the time signature here.

When you press the SEQUENCER START/STOP button to begin recording, the time signature you specify will be recorded on the Master Track and on the already-recorded tracks.

Be aware that if you press the SEQUENCER START/STOP button during the pre-count to stop recording, the time signature will not be recorded.

Normally, you will specify the time signature when you record the first track, and select */** when recording subsequent tracks.

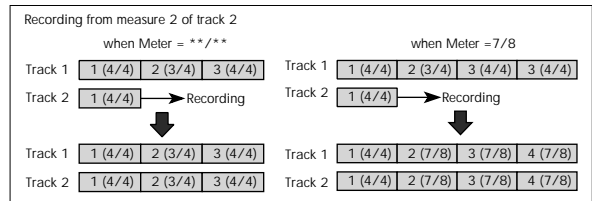

Changing the time signature in the middle of a song

If you know beforehand the location at which you wish to change time signatures in the middle of a song, use the “Insert Measure” menu command to specify and insert the time signature for each measure of the same time signature, and then record your musical data.

If you wish to change the time signature in the middle of a song which already contains musical data, use **Track Select** to specify the Master Track (or any Track01–16 which contains data), and use the “MIDI Event Edit” menu command to modify the time signature of the Bar event. You can also change this by specifying an audio track and using the “Automation Edit” menu command.

If the number of beats in a measure increases when you modify the time signature, rests will be inserted in the portion that was added. Conversely if the number of beats decreases, that portion will not be played. However if you return to the original time signature, the data that had been hidden will once again be played. (The data itself will not be erased.)

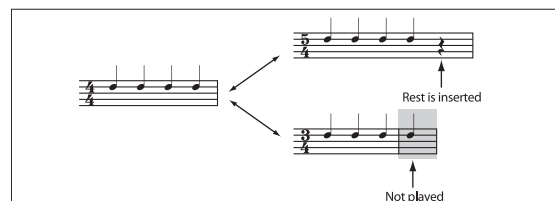

Tempo Mode [Auto, Manual, REC]

Auto: The tempo will follow the tempo of the Master Track. The tempo of the master track can be specified by using the **MIDI Event Edit** menu command, with the Master Track chosen in **Track Select**, or by the REC operation described below. When Auto is selected, it will not be possible to modify the “♪ (Tempo)” setting while a song is playing or recording (or during standby).

Manual: The “♪ (Tempo)” setting will be used.

REC: Tempo changes will be recorded on the Master Track.

♪ (Tempo) [040.00...300.00, EXT]

This specifies the tempo of the song. This tempo applies to song playback and Arpeggiator, etc.

040.00...300.00: When the “Tempo Mode” is Manual, this tempo will be used for recording and playback. When “Tempo Mode” is REC, this tempo will be recorded on the master track.

EXT: This will appear when **MIDI Clock (GLOBAL 1–1a)** is set to either External MIDI or Auto. The tempo of the internal sequencer will synchronize with MIDI Clock messages received from an external sequencer or other MIDI device, between 40 and 240 BPM.

If **MIDI Clock** (GLOBAL 1-1a) is set to “Internal,” the above tempo setting (040.00-240.00) is used. If you’ve selected Auto, operation will automatically switch from Internal to External if MIDI Clock data is received from an external MIDI device connected to the MIDI IN connector, and this indication will appear.

Note: You can set the tempo by pressing the TAP button at the desired interval.

Note: If Tempo is selected as an alternate modulation source, ♩ = 120.00 will be the base value.

To record tempo changes

First, set **Track Select** to a MIDI Track.

Press the SEQUENCER REC button to enter recording-standby mode, you will be able to select REC.

Set **Tempo Mode** to **REC**, start recording, and change the system tempo. You can also vary the tempo by pressing the TAP button at the desired timing.

This cannot be selected when the Preferences page item **Recording Setup** is set to Loop All Tracks.

When you change the “♩(Tempo)” value while recording, the tempo changes will be recorded, causing the tempo to change as the song progresses.

 You can’t record tempo changes during audio recording.

Tempo changes can also be created using the “MIDI Event Edit” or “Create Control Data” menu commands.

Note: If you wish to record only the tempo changes, set **Recording Setup** (0-5a) to Overdub, and the tempo will be recorded on the master track without being affected by the musical data of **Track Select**.

Song Select [000...199]

Select the song that you want to record or play back.

Either select the song name from the popup menu.

When the Song Select window is open, you can use the Find button to search for Songs by name. For more information, see “Find dialog” on page 7.

Selecting a new song

Choose a Song from the popup menu whose name starts with “New Song,” to specify the song number and press the ENTER button to open the dialog box. Then use the **Set Song Length** menu command (on SEQUENCER > Track Edit) to specify the number of measures in the song, and press the OK button.

Note: You can use **Set Song Length** to change the length of a song at any time. For instance, when creating a new song you might set the length to be somewhat longer than necessary, and then after you have finished recording and editing, use **Set Song Length** to specify the correct length.

 If **MIDI Clock** (GLOBAL 1-1a) is set to **Internal** (or **Auto**, if no MIDI clocks are being received), changing the song will cause Song Select and Song Position Pointer messages to be transmitted.

If **MIDI Clock** is set to **External MIDI** or **USB** (or **Auto MIDI** or **USB**, if MIDI clocks are currently being received), the NAUTILUS will change songs in response to received Song Select messages.

 When the song changes, tracks whose track **Status** is EXT, EX2 or Both will transmit Bank Select, Program Change, Volume, Pan, Portamento, Send1, 2, Post IFX Pan, and Post IFX send 1, 2 messages on their respective MIDI channels.

Track Select[MIDI Track01...MIDI Track16, Master Track, Audio Track01...Audio Track16]

MIDI Track 01–MIDI Track 16: Select the MIDI track that you want to record. This is also where you make your selection when editing a MIDI track in Track Edit page.

When **Multi Rec** is off, this also selects the record-enabled track.

When **Multi Rec** is on, the **Play/Rec/Mute** buttons (0-1b, 0-2a) select the record-enabled tracks, regardless of the **Track Select** setting.

Use Track Edit–MIDI Track Name page, Audio Track Name page to give the track a descriptive name.

 If other tracks are set to the same MIDI channel as the selected track, and their **Status** is set to INT or Both, they’ll be controlled by the keyboard as well.

Also, if other tracks are set to the same MIDI channel as the selected track, and their **Status** is set to EXT, EX2, or Both, they’ll transmit MIDI to external devices. For another look at this, see the table below.

| MIDI Channel | Status | Keyboard plays Internal Sounds | Keyboard Transmits MIDI Out |
|--|-------------|--------------------------------|-----------------------------|
| Same as the selected MIDI Track | OFF | No | No |
| | INT | Yes | No |
| | EXT | No | Yes |
| | EX2 | No | Yes |
| | Both | Yes | Yes |
| Different from the selected MIDI Track | Any setting | No | No |

If you’ve selected Master Track or Audio Track 01–16, the settings of the most recently selected MIDI track will be used.

Master Track: Select the master track if you want to use the Track Edit page menu commands to edit the master track. You cannot perform realtime recording or step recording on the master track by itself.

Audio Track 01...Audio Track 16: Select the audio track you want to record. You will also select one of these when you want to edit an audio track in Track Edit page, etc.

In the same way as for MIDI tracks, the data will be recorded on the selected track if you’re using single-track recording. If you want to perform multi-track recording, turn on **Multi REC** (0-1a), and use the **Play/Rec/Mute** buttons (0-1b, 0-2a) to select the tracks you want to record.

 You can record up to four audio tracks simultaneously.

REC Resolution (Realtime REC Quantize Resolution)



This lets you correct timing as you record. It applies to all MIDI data, including notes and continuous controllers, as well as audio track automation.

Note that this does not affect previously-recorded data, or audio event data.

Important: The **REC Resolution** affects *all* MIDI and audio automation data. This can cause “stair-steps” in recorded controller data, such as pitch bend.

If you don’t want this effect, set **REC Resolution** to **Hi** when recording, and then use the **Quantize** menu command afterward to correct only the desired type of data (such as notes).

Hi (High Resolution): Timing will not be corrected, and data will be recorded at the maximum resolution (1/480).

3/8 – 1/8: Timing will be corrected to the nearest interval of the specified rhythmic value. For example, if you select **3/8**, data will be corrected to the nearest 32nd-note triplet interval. If you select **1/8**, data will be corrected to the nearest quarter note interval.

Audio events are always recorded at the maximum, uncorrected resolution.

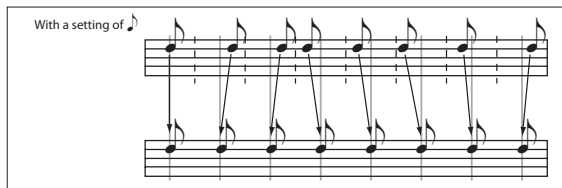

Multi REC [Off, On]

On (checked): Multi-track recording setup is enabled. Select this if you want to record two or more tracks simultaneously.

Use MIDI multi-track recording if you want to simultaneously record multiple MIDI tracks of different channels, such as when recording the output of the Arpeggiator or RPPR functions, or when recording from an external multi-track sequencer.

You can also record up to four audio tracks simultaneously.

When this is checked, you can select and record with multiple tracks. Press the **Mute/REC** button for the tracks you wish to record on, and switch to REC mode.

Regardless of the **Track Select** (0–1a) setting, data will be recorded on the MIDI tracks and audio tracks that are set to REC. MIDI data will be recorded on the tracks of the matching MIDI channel.

For details on how to record from Arpeggiator or an external multi-track sequencer onto multiple tracks of different MIDI channels, see “Synchronizing the playback of arpeggiator or sequencer” on page 938, and “Recording the sound of a Combination or Program” on page 85 of the OG.

Note: If you’re recording data from an external multi-track sequencer, set **MIDI Clock** (GLOBAL 1–1a) to External MIDI so that the NAUTILUS will synchronize to your external sequencer. Tempo changes cannot be recorded.

Off (unchecked): Single track recording setup will be selected. Recording will occur on the track selected by **Track Select**.

Warning: This cannot be selected if **Recording Setup** is set to Loop All Tracks.

If Track Select is MIDI1–8 or MIDI9–16:

0–1b: Status Play/Mute

RPPR On/Off [Off, On]

This turns the RPPR (Realtime Pattern Play/ Recording) function on/off. RPPR lets you assign a pattern to each note of the keyboard, so that the pattern will playback (or be recorded) when you press the appropriate key.

On (checked): The RPPR function will be on. If a pattern has been assigned to each key in the P5: RPPR Setup page, pressing that key will perform the assigned pattern. For details, see “5–3: RPPR Setup” on page 504.

<|> indicator and “Samples Not Loaded” message

Warning: If the multisamples, samples or drum samples of the EXs and user sample banks for the program assigned to a track have not been loaded, the track will not make a sound. When this happens, the <|> icon will show up in the program name for that track, and the message “Samples Not Loaded” will appear at the top of the display. Once you load the necessary sample data for the EXs and user sample banks, the icon and message will disappear.

Track 01 (Track Number)

This shows the MIDI track number. The parameters below this let you make settings for the track.

Track Category

Displays the category (abbreviated) for the Program.

Program Select [0...127 (A...T Banks), 1...128 (GM Banks)]

Selects the program that will be used by each MIDI track.

The lower line displays part of the program name.

The program you select here will be used when the song is played or recorded from the beginning. If the program is changed while recording, the program change will be recorded as musical data, and the program will change during playback. You can also change the program manually during playback. However if musical data (program change data) is already recorded, the program will change at that point.

MIDI If the **Status** (2–1a) is either INT or Both, programs can be selected by receiving MIDI program change messages. Also, when the song is changed or when the song returns to the beginning, tracks whose **Status** is EXT, EX2 or Both will transmit the bank and program numbers via MIDI. Tracks whose **Status** is EX2 will show Bank as “–” and will transmit the bank number that was selected in the “Bank Select” (2–1b) parameter.

Various ways to change the program for a track

- Choose “Program Select,” and turn the VALUE dial or use the +/- buttons.
- Use the Bank/Track Program Select menu to view and select programs by bank.
- Use the Category/Track Program Select menu to view and select programs by category.

- Use the Favorite function; in the Bank/Track Program Select menu or the Category/Track Program Select, you can view and select programs whose “Favorite” setting is turned on.
- Use the Find feature. In either of the Select menus, you can use the Find button to search for Programs by name. For more information, see “Find dialog” on page 7.
- Transmit MIDI program change messages from a connected external MIDI device (if the track **Status** is INT or Both).
- You can also use the above methods to **switch programs while a song is playing**. If you switch programs while recording, the program change data will be recorded, and the program will switch at that point in the song during playback. You can also use the page menu command “MIDI Event Edit” to add program change data to a track.

CX-3: Limitations on EXi fixed resources

Under certain circumstances, there may be limitations on the number of particular EXi Programs that you can load simultaneously. For more information, please see “CX-3 & other EXi: Limitations on EXi fixed resources” on page 380.

Mute/REC [Mute Off, Mute On, REC]

Use this to mute a MIDI track, or to select the recording tracks for multi-track recording. During playback, or for single-track recording (normal recording), it is possible only to select Mute Off or Mute On for tracks (playback tracks) other than the recording track. For multi-track recording, tracks can be set to Mute Off, REC, or Mute On. The setting will alternate each time you press the Mute/REC button.

Mute Off: The track will play.

REC: This will be displayed during single-track recording (normal recording). It cannot be selected.

When you use multi-track recording (when the Preferences page “Multi REC” is on), select REC for the tracks that you wish to record.

Mute On: The track will be muted (silent).

Solo On/Off [On, Off]

This turns the Solo function on/off.

Only tracks with SOLO On will sound. Other tracks will be muted.

The setting will alternate on/off each time you press the Solo button.

The operation will depend on the **Exclusive Solo** setting.

Exclusive Solo off: Multiple tracks can be soloed. The solo setting of each track will change each time you press its Solo On/Off button.

Exclusive Solo on: When you press a Solo On/Off button, only that track will be soloed.

Note: The Solo function applies to MIDI tracks 1–16, audio tracks 1–16, and audio inputs 1–2.

MIDI If MIDI tracks whose **Status** (2–1a) is Both, EXT, or EX2 are muted by Mute or by the Solo function, note on/off messages will not be transmitted on the MIDI channel selected for those tracks.

Solo settings are not saved with the song.

0-1c: Volume

Recording MIDI Track Pan and Volume

The pan and volume that you specify here will be used when you playback or record from the beginning of the song. If you change the settings during recording, the changes will be recorded as musical data, and pan and volume will change during playback. You can also change the settings during playback. However when the song reaches a location where pan or volume data was recorded, the settings will change accordingly.

Pan [RND, L001...C064...R127]

This specifies the pan of MIDI track.

L001...C064...R127: A setting of L001 is far left and R127 is far right. A setting of C064 will reproduce the oscillator pan setting of the PROGRAM mode.

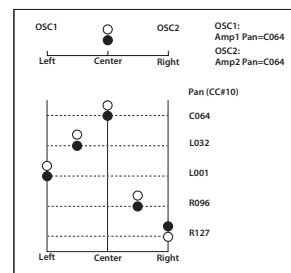
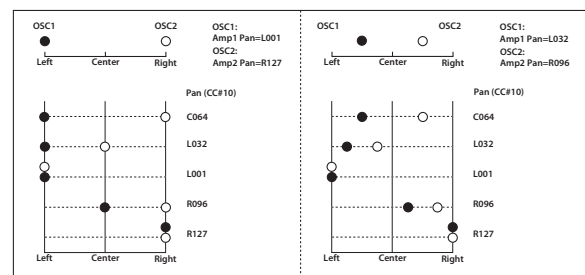

If a mono insert effect is in use, the settings you make here will be ignored. In this case, the “Pan (CC#8)” parameter in IFX– Insert FX page will adjust the panning of the sound after the Insert Effect. For details, see “Mixer” on page 748.

RND: The pan will change randomly at each note-on.

MIDI If **Status** (2–1a) is INT or Both, CC#10 Pan can be received to control the panning. When receiving CC#10, a value of 0 or 1 is far left, 64 is center, and 127 is far right. When you change the song or return to the beginning of the song, tracks whose **Status** is EXT, EX2 or Both will transmit the pan you specify here as a MIDI message (except for RND).

Volume [000...127]

This fader adjusts the volume of the MIDI Track. The meter to the left of the fader displays its audio level in realtime, showing the combined peak signals of the left and right channels.

MIDI When **Status** (2–1a) is INT or Both, CC#7 Volume can be received to control the volume. The volume of a track is determined by multiplying the MIDI Volume (CC#7) and Expression (CC#11) values. When you change the song or return to the beginning of the song, tracks whose **Status** is EXT, EX2 or Both will transmit the volume you specify here as a MIDI Volume message.

Track 02...16 (Track Number)

For more information, please see “Track 01 (Track Number)” on page 446.

If Track Select is AUDIO1-8 or AUDIO9-16:

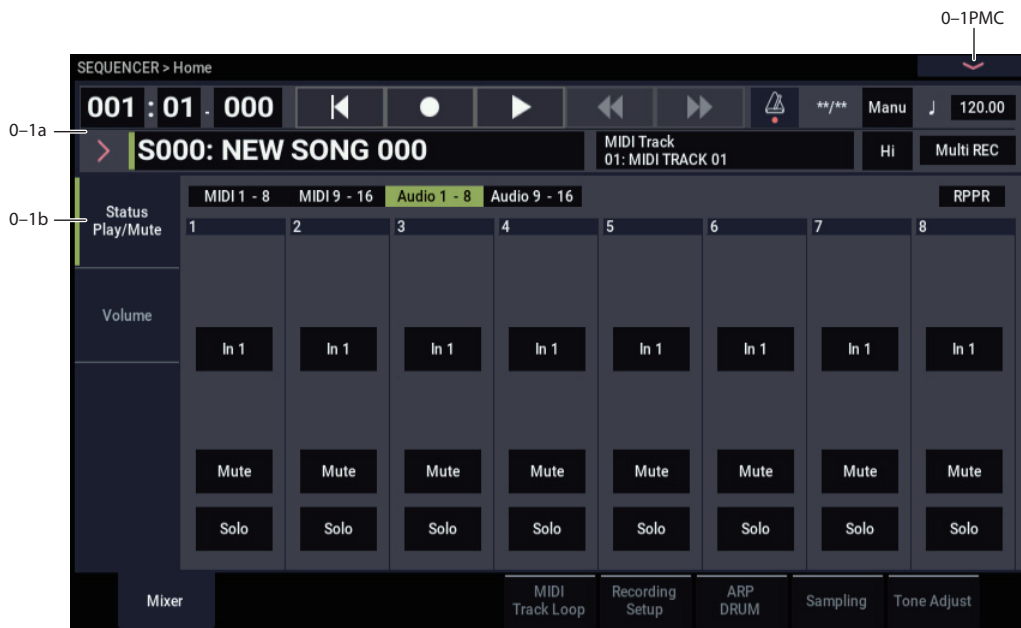

Here you can make settings for recording and playback of audio tracks in the song. You can specify the audio source for recording, and change the Mute status, Solo status, pan, and volume for playback.

0-1b: Status Play/Mute

Selected Track Info

This displays information about the currently selected MIDI or audio track. For more information, see “0-1b: Status Play/Mute” on page 446.

Track 01 (Track Number)

This indicates the audio track number. The parameters below this track number are the settings for that track.

REC Source [(Stereo Pair Off): Audio Input1...2, USB1...2, L, R, REC1...4, Indiv.1...4]

[(Stereo Pair On): Audio Input1/2, USB 1/2, REC1/2...3/4, Indiv.1/2...3/4]

This selects the source that will be recorded on the track. The signal of the bus line you specify here will be recorded.

The available settings depend on whether or not Stereo Pair is enabled for the track.

Audio Input 1...2 (mono) or 1/2 (stereo): Choose these to record directly from analog inputs 1-2.

The input signal will be recorded directly, without passing through any buses or effects, and without being affected by the audio input mixer settings.

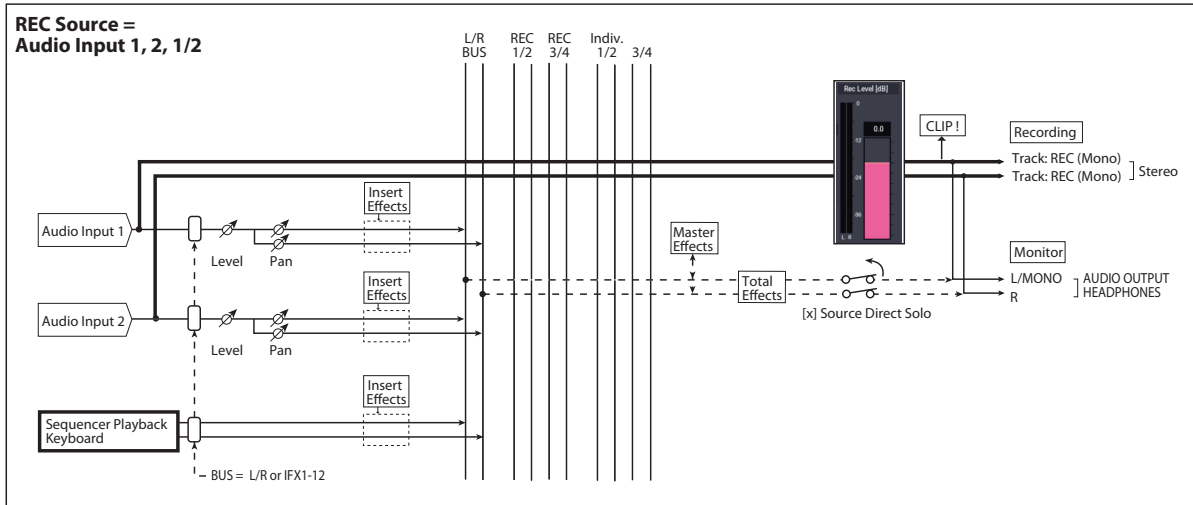

If **Stereo Pair** is on, input 1 is sent to odd-numbered tracks, and input 2 is sent to even-numbered tracks.

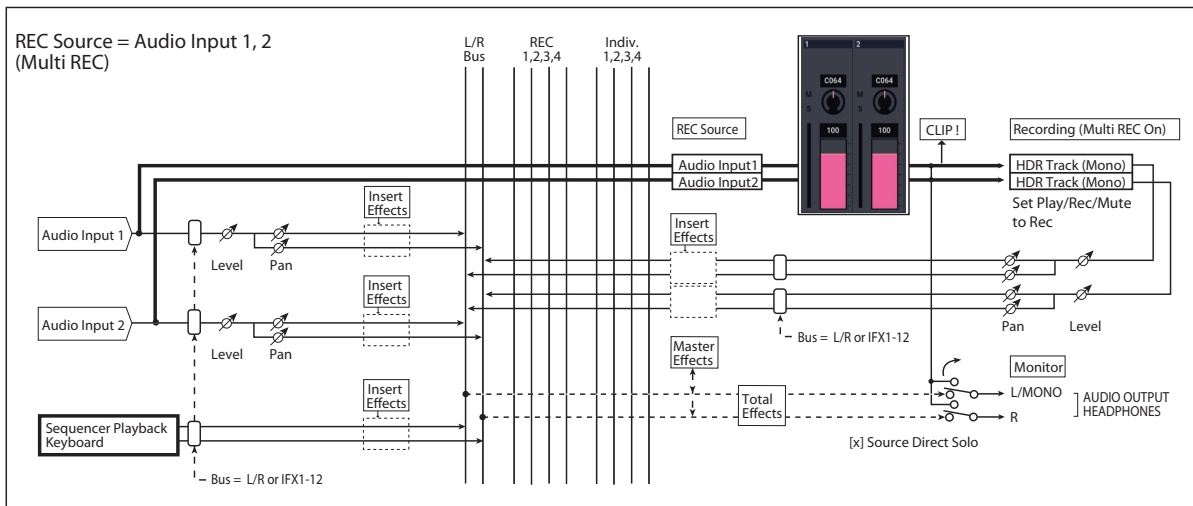

USB 1, 2, USB 1/2: Set this when you want to record the audio input from the USB jack. This directly records the USB input signal from the USB jack without going through the L/R bus, REC bus, the individual buses and other internal buses. The USB 1 and 2 inputs will be linked

directly, regardless of the “Pan”, “Level”, “Solo” and “Mute” settings of Audio Input (0–8a). (See the “REC = USB 1, 2” diagram.)

If **Stereo Pair** is on, USB L is sent to odd-numbered tracks, and USB R is sent to even-numbered tracks.

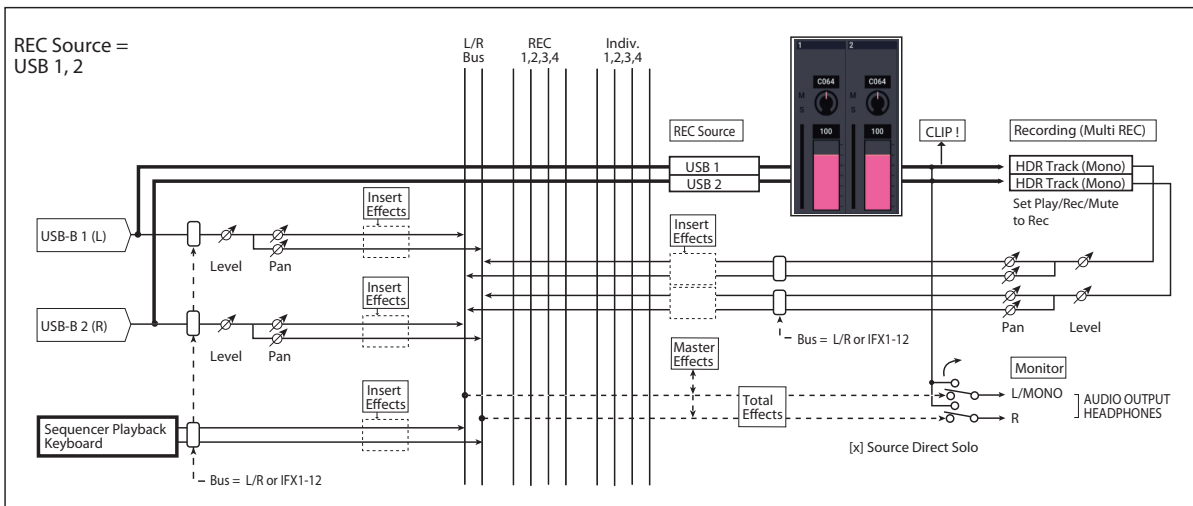

L, R, L/R: This is the L/R bus, after passing through both TFX 1 and 2. Choose this if you want to record an external audio signal being sent to the L/R bus (specified by 0-8a), or the sound being produced by the NAUTILUS (and sent to

the L/R bus) in response to sequencer playback, keyboard playing, or MIDI input. See the diagram “REC Source = L, R,” below.

If **Stereo Pair** is on, L is sent to odd-numbered tracks, and R is sent to even-numbered tracks.

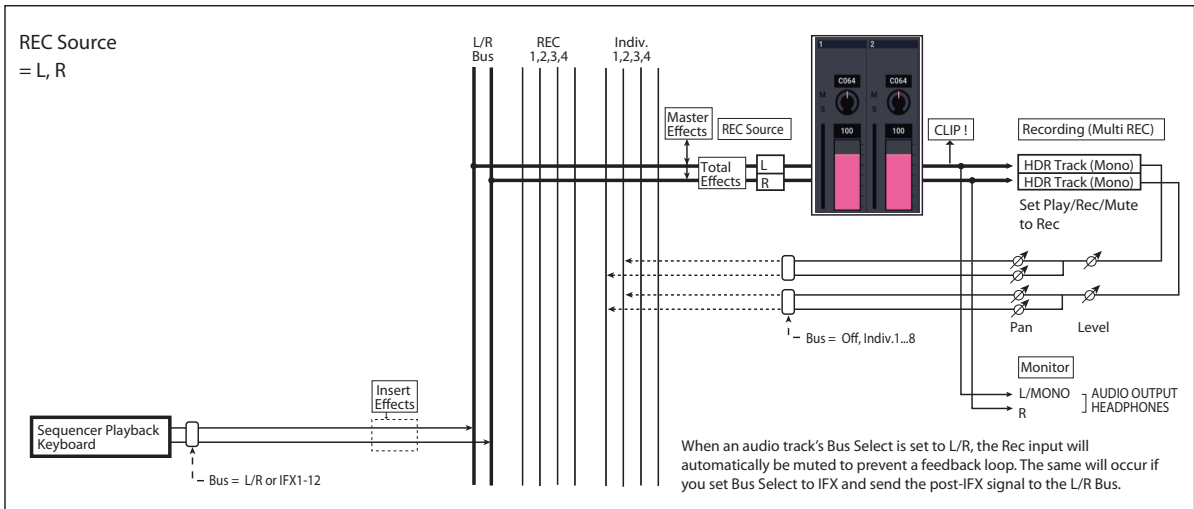

REC 1, 2, 1/2, REC 3, 4, 3/4: The REC 1/2 or REC 3/4 buses will be recorded. Choose this if you want to record only the audio input while hearing the sequencer playback and your keyboard playing from the L/R outputs. You can also mix several audio inputs to the REC buses, or use the REC buses to mix the direct sound from the audio inputs

with the sound processed by insert effects, and record the result. For more information, see the diagram “REC Source = REC Bus 1, 2.”

If **Stereo Pair** is on, REC Bus 1 (3) is sent to odd-numbered tracks, and REC Bus 2 (4) is sent to even-numbered tracks.

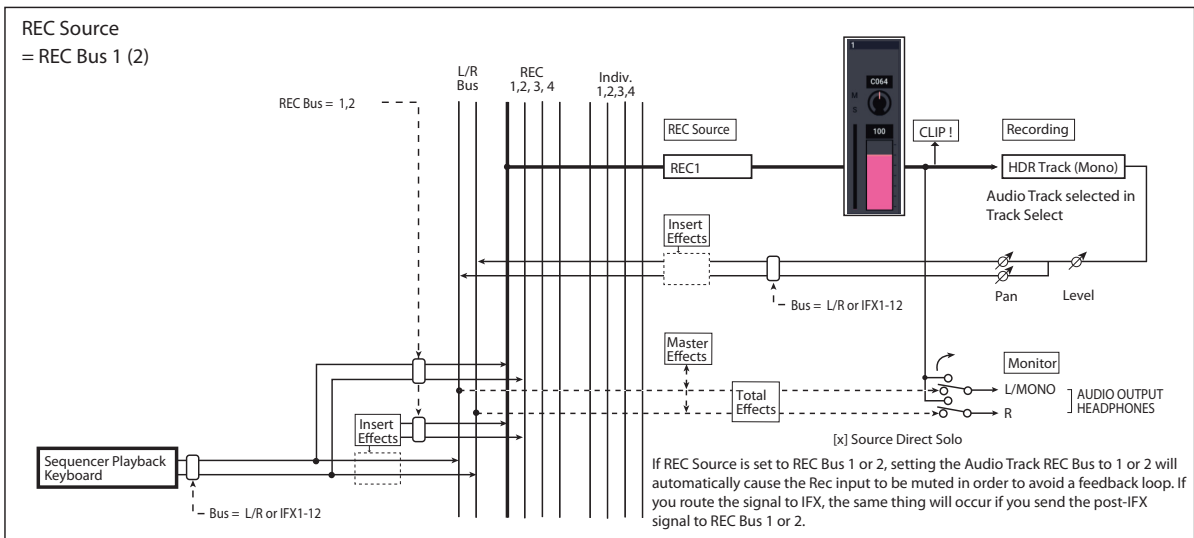

Indiv.1...4 (mono), Indiv.1/2...3/4 (stereo): The Indiv.1/2–Indiv.3/4 output buses will be recorded. Similarly to when using the REC buses, you can choose this when you want to monitor the L/R output while recording only the audio input. For more information, see the diagram “REC Source = Indiv. 1, 2 (3, 4).”

If **Stereo Pair** is on and you’ve selected Indiv.1/2, the Indiv. bus 1 will be sent to odd-numbered tracks, and Indiv. bus 2 will be sent to even-numbered tracks.

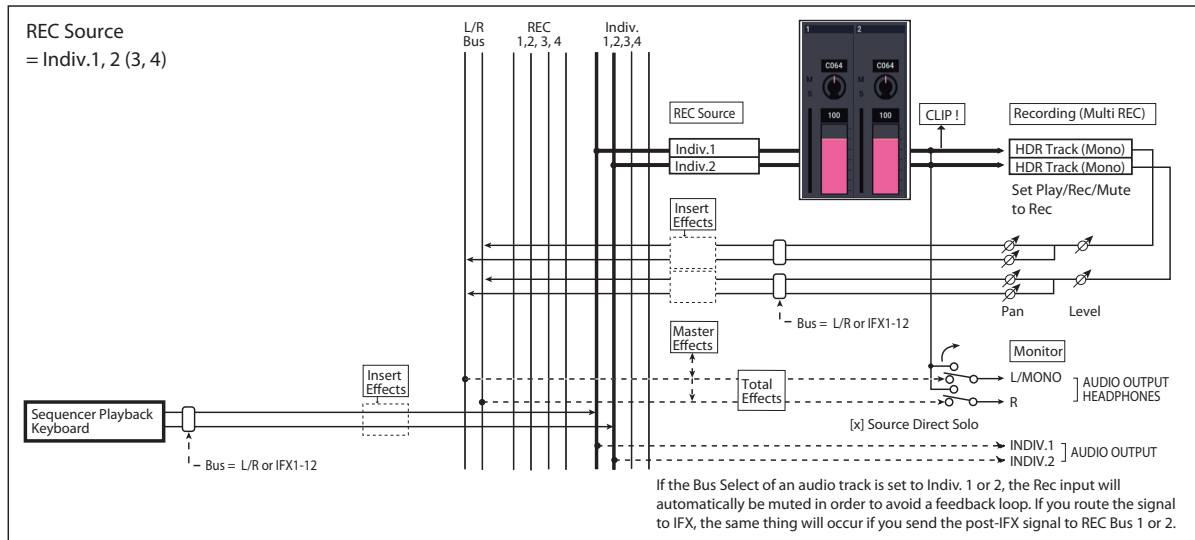

STEREO

This is shown if **Stereo Pair** is on.

Mute/REC [Mute Off, Mute On, REC]

Use this to mute an audio track, or to select the recording tracks for multi-track recording. During playback, or for single-track recording (normal recording), it is possible only to select Mute Off or Mute On for tracks (playback tracks) other than the recording track. For multi-track recording, tracks can be set to Mute Off, REC, or Mute On. The setting will alternate each time you press the **Mute/REC** button.

Mute Off: The track will play.

REC: This will be displayed during single-track recording (normal recording). It cannot be selected. When you use multi-track recording (the Preferences page “Multi REC” is on), select REC for the tracks that you wish to record. You can specify REC for up to four tracks.

Mute On: The track will be muted (silent).

Solo On/Off [On, Off]

This turns the Solo function on/off.

Only tracks that are set to Solo On will sound. Other tracks will be muted.

The setting will alternate on/off each time you press the Solo button.

The operation will depend on the setting of the **Exclusive Solo** menu command, as described below:

Exclusive Solo off: Multiple tracks can be soloed. The solo setting of each track will change each time you press its Solo On/Off button.

Exclusive Solo on: When you press a Solo On/Off button, only that track will be soloed.

Note: The Solo function applies to MIDI tracks 1–16, audio tracks 1–16, and audio inputs 1–2.

Solo settings are not saved with the song.

0–1c: Volume

Recording Audio Track Pan and Volume

The pan and volume that you specify here will be used when you playback or record from the beginning of the song. If you modify these settings while recording, your changes will be recorded as automation event data on the automation track for each audio track, and the pan and volume data will change accordingly during playback. You can also change the settings during playback. However when the song reaches a location where pan or volume data was recorded, the settings will change accordingly.

Pan [L000...C064...R127]

This specifies the pan of audio track.

L000...C064...R127: L000 is hard left, and R127 is hard right.

If a mono insert effect is in use, the settings you make here will be ignored. In this case, the “Pan (CC#8)” parameter in IFX– Insert FX page will adjust the panning of the sound after the Insert Effect. For details, see “Mixer” on page 748.

For paired audio tracks, the above parameters are controlled by the odd-numbered audio track.

These parameters will not be controlled if you edit the even-numbered audio track.

If, however, in the **Stereo Pair** page menu command you set “Pan Mode” to **Index**, the **Pan** of the even-numbered audio track will be valid.

Volume [000...127]

This fader adjusts the volume of the Audio Track. The meter to the left of the fader displays its audio level in realtime.

For paired audio tracks, the above parameters are controlled by the odd-numbered audio track.

These parameters will not be controlled if you edit the even-numbered audio track.

Track 02... 16 (Track Number)

For details, see “Track 01 (Track Number)” on page 449.

✓ 0-1: Page Menu Commands

- Compare →p.112

- Memory Status →p.521
- Exclusive Solo →p.113
- Rename Song →p.521
- Initialize Song →p.522
- Copy From Song →p.522
- Load Template Song →p.522
- Save Template Song →p.523
- FF/REW Speed →p.523
- Set Location (for Locate Key) →p.523
- GM Initialize →p.523
- Copy from Combi →p.525
- Copy From Program →p.525
- Stereo Pair →p.525
- Auto HDR/Sampling Setup →p.527
- Add To Set List →p.113
- Edit Program →p.434
- Load required samples →p.114

- PAGE →p.126
- MODE →p.126

0-5: MIDI Track Loop

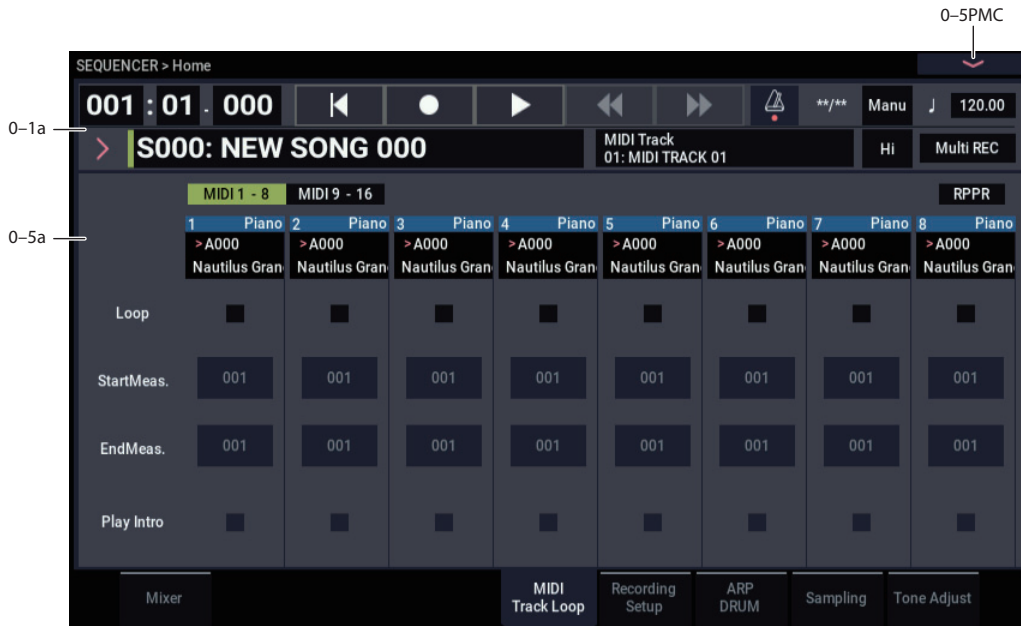

When playing or recording a song, you can independently loop the MIDI tracks.

0-5a: Track Select

Selected Track Info

This displays information about the currently selected MIDI or audio track. For more information, see “0-1b: Status Play/Mute” on page 446.

Track 01 (Track Number)

Category [(00...17)]
Indicates the category.

Track Play Loop [Off, On]
Specifies looping for a MIDI track.

On (checked): That track will loop between “Loop Start Measure” and “Loop End Measure.”

Loop Start Measure [001...999]
Specifies the first measure of the loop.

Loop End Measure [001...999]
Specifies the last measure of the loop.

Play Intro [Off, On]
On (checked): After the measures before the specified “Loop Start Measure” are played once, the region of “Loop Start Measure” – “Loop End Measure” will be played repeatedly.

For example, you can use this on a drum track to make it play a fill-in and then begin looping.

Off (unchecked): Playback will begin from the “Loop Start Measure,” and will begin looping immediately.

⚠ This will be valid if “Track Play Loop” is checked and “Loop Start Measure” is set to other than 001.

Example) When “Play Intro” is checked

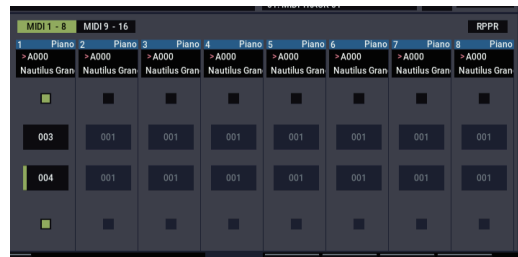

Track 1 will loop as follows.

M001 – M002 – M003 – M004 – M003 – M004 – M003 – M004...

When “Play Intro” is not checked



Track 1 will loop as follows.

M003 – M004 – M003 – M004 – M003 – M004 – M003 – M004...

In this way, you can use “Track Play Loop” to make the realtime recording process more efficient.

Track 02... 16 (Track Number)

For details, see “Track 01 (Track Number)” on page 449.

✓ 0-5: Page Menu Commands

- Compare →p.112
- Memory Status →p.521
- Exclusive Solo →p.113
- Rename Song →p.521
- Initialize Song →p.522
- Copy From Song →p.522
- Load Template Song →p.522
- Save Template Song →p.523
- FF/REW Speed →p.523
- Set Location (for Locate Key) →p.523
- GM Initialize →p.523
- Copy from Combi →p.525
- Copy From Program →p.525
- Stereo Pair →p.525
- Auto HDR/Sampling Setup →p.527
- Add To Set List →p.113
- Load required samples →p.114
- PAGE →p.126
- MODE →p.126

0-6: Recording Setup

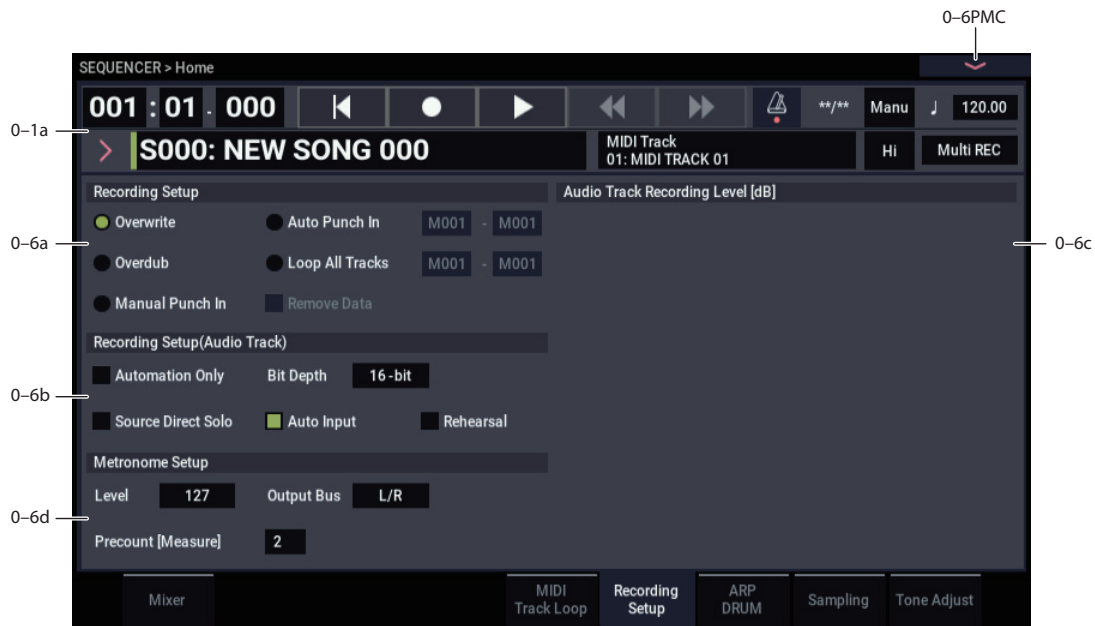

Here you can specify the realtime recording method, adjust levels and make other settings for audio recording, and adjust the metronome settings.

Selected Track Info

This displays information about the currently selected MIDI or audio track. For more information, see “0-1b: Status Play/Mute” on page 446.

0-6a: Recording Setup

Selects the method of realtime recording.

For detailed, step-by-step instructions, please see “MIDI recording” on page 76 of the OG.

Overwrite

When recording for the first time, you will normally select this method.

To begin recording, press the SEQUENCER REC button and then the SEQUENCER START/STOP button. To stop recording, press the SEQUENCER START/STOP button once again.

If you use this method to record on a track that has already been recorded, the result will differ depending on the track or type of event, as follows.

MIDI Tracks, Audio Track Automation Events: All data following the measure at which you begin recording will be erased.

Audio Track Audio Events: As with Overwrite, only the measures you recorded will be overwritten; the data in subsequent measures will remain unchanged.

Overdub

Select this method when you wish to add data to a previously-recorded track. (except for audio events)

To begin recording, press the SEQUENCER REC button and then the SEQUENCER START/STOP button. To stop recording, press the SEQUENCER START/STOP button once again.

If you use this method to record on a track that has already been recorded, the result will differ depending on the track or type of event, as follows.

MIDI Tracks, Audio Track Automation Events: The previously-recorded data will remain, and the newly-recorded data will be added to it.

Audio Track Audio Events: As with Overwrite, only the measures you recorded will be overwritten; the data in subsequent measures will remain unchanged.

Manual Punch In

Select this method when you wish to use the SEQUENCER REC button or a foot switch to re-record selected portions of a previously-recorded track.

Press the SEQUENCER START/STOP button to playback the song. When you reach the measure at which you wish to begin re-writing the data, press the SEQUENCER REC button or the foot switch, and recording will begin. When you are finished recording, press the SEQUENCER REC button or the foot switch once again, and recording will end.

Auto Punch In

Select this method when you wish to automatically re-record selected portions of a previously-recorded track.

If you select Auto Punch In, the display will indicate “M***-M*** (Auto Punch In Start Measure–Auto Punch In End Measure)” at the right, allowing you to specify the range of measures that will be rewritten.

Press the SEQUENCER REC button and then the START/STOP button, and playback will occur until the specified measure is reached. Then, recording will occur only over the specified area (**Start Measure–End Measure**), rewriting it with the newly recorded data.

Auto Punch In Start Measure [M001...M999]

Auto Punch In End Measure [M001...M999]

When **Recording Setup** is set to Auto Punch In, specify the measures at which recording will start and end.

Loop All Tracks

Select this method when you wish to repeatedly record a specified area of a track, and continue adding data. This is suitable for creating drum patterns, etc.

If you select Loop All Tracks, the display will indicate “M***–M*** (Loop Start Measure–Loop End Measure)” at the right, allowing you to specify the range of measures that will be recorded repeatedly.

Press the SEQUENCER REC button and then the SEQUENCER START/STOP button, and playback will occur until the specified measure is reached. Then, recording will occur repeatedly over the specified area (“Loop Start Measure”–“Loop End Measure”). Previously-recorded data will remain, and the new data will be added. This applies only to MIDI data.

While recording, you can check “Remove Data” to delete unwanted data.

 You can't record audio events to audio tracks while using Loop All Tracks. If you set **Track Select** to an audio track, and leave “Automation Only” (0–5b) unchecked, you won't be able to start recording. Checking “Automation Only” will allow you to start recording so that you can record automation events. You can use “Remove Data” to delete audio track automation events.

 If **Multi REC** is checked, this parameter will not be available.

Loop Start Measure [M001...M999]

Loop End Measure [M001...M999]

Specifies the range of measures over which recording will repeat when **Recording Setup** is set to Loop All Tracks.

Remove Data [Off, On]

Use this to delete unwanted MIDI data or audio track automation events that you recorded while using Loop All Tracks. This is available when **Recording Setup** is set to Loop All Tracks.

On (checked): You can delete unwanted MIDI data while recording with Loop All Tracks. During recording, press the key (note number) that corresponds to the MIDI data you wish to delete. All occurrences of that note number will be deleted for the interval that you continue holding down the key. Controller data can also be erased in a similar way. For example while you move and hold the joystick in the X (horizontal) direction, bender data will be erased. This applies to Joystick+Y (CC#01)/–Y (CC#02), Joystick X (Pitch Bend).

Also, you can press and hold down the SEQUENCER REC button to delete all MIDI data for as long as the key is held.

If you want to delete audio track automation events, check “Automation Only” (0–6b), choose Loop All Tracks, and begin recording. Then check “Remove Data” (0–5a) and hold down the SEQUENCER REC button to delete the automation events that occur while you're holding down that switch.

0–6b: Recording Setup (Audio Track)

Automation Only [Off, On]

On (checked): Only audio track automation events will be recorded. Audio events will not be changed.

Off (unchecked): Both audio track automation events and audio events will be recorded.

Auto Input [Off, On]

This switches the monitor channel (**REC Source**/ track playback) for the audio track selected in **Track Select**. See the table that follows.

If “Multi REC” is on, this applies to all tracks whose **Mute/REC** button is set to REC.

On (checked): When performing auto/manual punch-in recording, the audio track selected in **Track Select** will be monitored via its **REC Source** during the measures being recorded, and the track playback will be monitored during measures that are not being recorded.

For the audio tracks not selected in **Track Select**, you will always be monitoring the track playback.

When performing auto/manual punch-in recording with “Multi REC” on, audio tracks whose **Mute/REC** button is set to REC will be monitored via **REC Source** during the measures being recorded, and will automatically switch to monitoring the track playback during measures that are not being recorded.

For the audio tracks that are not set to REC, you will always be monitoring the track playback.

Off (unchecked): The audio track selected in **Track Select** will always be monitored via its “REC Source.”

For the audio tracks not selected in **Track Select**, you will always be monitoring the track playback.

If “Multi REC” is on, you will always be monitoring the **REC Source** of audio tracks whose **Mute/REC** button is set to REC.

For the audio tracks that are not set to REC, you will always be monitoring the track playback.

Audio track monitor channels

(Line: REC Source, Track: track playback)

| | Auto Input | During Stop | During Play | During Rec | During Punch Rec | | |
|----------------------------------|------------|-------------|-------------|------------|------------------|----------|---------|
| | | | | | ...In | In...Out | Out... |
| Track Select track | On | Line | Track | Line | Track | Line | Track * |
| | Off | Line | Line | Line | Line | Line | Line |
| Tracks other than “Track Select” | On | Track | Track | Track | Track | Track | Track |
| | Off | Track | Track | Track | Track | Track | Track |

Source Direct Solo [Off, On]

On (checked): Only the signal of the bus line specified by **REC Source** will be output to the L/R jacks and the headphone jack. Check this if you want to monitor only the sound that's being recorded. When using Multi REC, you'll hear the sound from the **REC Source** buses whose **Mute/REC** button setting is set to REC.

Audio Input/Output

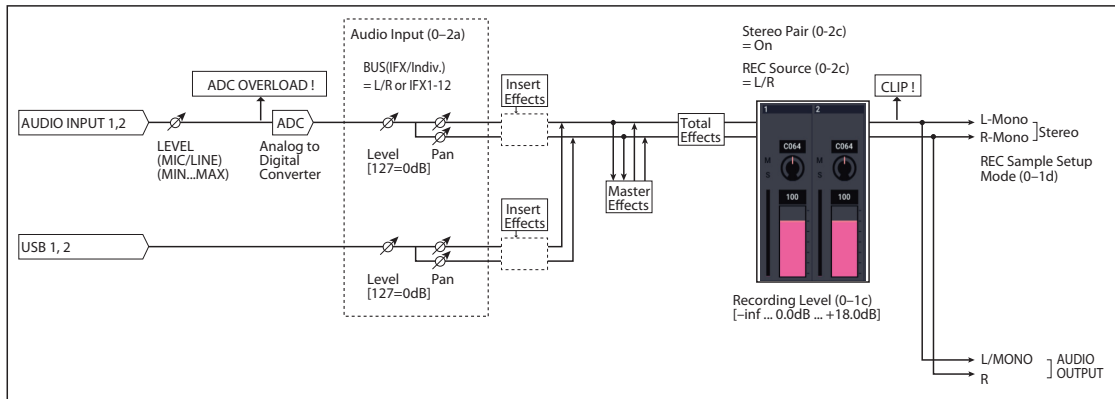

Off (unchecked): The L/R (post-TFX) and bus line signal(s) specified by **Source Bus** will be sent from the L/R jacks and the headphone jack as specified by the Audio Input “Bus Select (IFX/Indiv. Out Bus Select)” (8–3a) and post-IFX **Bus Sel.** (8–5a) settings. This is the normal state.

Note: If the **Source Bus** is L/R, this setting is ignored; the L/R (post-TFX) signal is output from the L/R jacks and the headphone jack.

Rehearsal [Off, On]

On (checked): Recording to the audio track(s) will be simulated (recording will not actually occur).

The monitoring during rehearsal will depend on the “Auto Input” setting. If “Auto Input” is checked, you will monitor the external input between punch-in and punch-out, and monitor the already-recorded sound at other times.

For example if you set punch-in at 005 (measure 5) and punch-out at 008 (measure 8), you will monitor the already-recorded sound during measures 1 to 4 and measures 9 to the end, and monitor the external input during measures 5 to 8.

Bit Depth [16-bit, 24-bit]

Sets the bit length of the WAVE file created on the internal drive when doing real-time recording of an audio track in SEQUENCER mode.

This is linked with “Audio Track Rec” on page 635 in GLOBAL mode. The settings are written in “Write Global Setting” in GLOBAL mode.

The bit length for WAVE files is shown as [16] or [24] when using the Region Edit command, in MEDIA mode and other locations.

0–6c: Audio Track Recording Level [dB]

Recording Level, Name, Take, and Take No. settings for the sixteen audio tracks are not maintained separately for each song; instead, they apply globally to the entire SEQUENCER mode.

This area displays the settings of the track selected in **Track Select** (for single track recording) or the settings of the tracks whose **Mute/REC** button is set to REC (for multi-track recording).

Audio Tracks 1...4

Recording Level 1...4 [-Inf, -72.0...+18.0]

Level Meter 1...4

This adjusts the final level of the signal being recorded from the **REC Source** to the audio track. Adjust the level optimally without allowing the level meter to reach the “CLIP !” indication.

The upper part of the level meter/slider shows the corresponding audio track number.

If you’re using single track recording, **Recording Level 1** and **Level Meter 1** are valid.

If you’re using multi-track recording, the settings for tracks whose **Mute/REC** button is REC will be valid.

When recording a single audio track, the signal level will appear in the level meters as soon as you set **Track Select** to an audio track. When recording multiple audio tracks via Multi REC, the signal levels will appear in the level meters when you press the SEQUENCER REC button to enter record-standby mode.

Use the sliders to adjust the signal levels.

For more information, see “Setting levels” on page 27, “Tips for eliminating distortion when using the analog inputs” on page 27, and “Avoiding extraneous noise” on page 27.

CLIP! message

If 0 dB is exceeded, the display will indicate “CLIP !” This means that the level of the sampling signal is too high, so adjust the level as described under “Setting levels” on page 27.

Note: When signals are input to the AUDIO INPUT 1/2 jacks, adjust the level in “Analog Input Setup” so that they are at their maximum without “ADC OVERLOAD!” being displayed. This will let you record at the widest dynamic range possible. Further, set the “Level” (0–8a) to “127”, and adjust the “Recording Level” so that the “CLIP!” message does not display.

Note that if the “Recording Level” is still distorted even after you lower the signal, analog inputs might still be distorted depending on the settings of the AUDIO INPUT stage or the internal effects. See the Home– Sampling page to check whether the signal levels of the AUDIO INPUT stage are overloading. Distortion is occurring in the AUDIO INPUT stage when “ADC OVERLOAD!” appears above the “Recording Level” bar. Adjust the levels in “Analog Input Setup” so that the message does not appear.

If the signal distorts even after you turn down the analog input gain, the settings of the internal effects may be causing the distortion. Try turning down “(Input 1, 2) Level” (0-8a) or adjusting the effect settings.

Name 1...4

Here you can specify the names of the regions and WAVE files that will be created when you record audio tracks.

You can use up to eight characters.

If you check **Take** at the right, the take number will automatically be input as the last two characters of the name. For more information, see **Take** (below).

Take **[Off, On]**

On (checked): The take number specified by **Take No.** will automatically be assigned as the last two characters in the name of the region and WAVE files that are saved. The number will automatically increment after recording. If you are recording repeatedly, you can use the take numbers to manage the separate recordings.

If **Take** is unchecked, you can input up to eight characters as the file name. If it is checked, you can input up to six characters.

Off (unchecked): The take number will not be included in the name of the subsequently-recorded region and WAVE files.

Take No. **[00...99]**

This specifies the take number that will be used if **Take** is checked. After each recording, this number will automatically increase by one from the previous take.

0-6d: Metronome Setup

Here you can make metronome settings.

Level **[000...127]**

Sets the volume of the metronome.

Output Bus **[L/R, L, R, 1...4, 1/2...3/4]**

Selects the output destination of the metronome sound.

L/R, L, R: Output from OUTPUT (MAIN) L/Mono and/or R.

1...4, 1/2...3/4: Output from OUTPUT (INDIVIDUAL) 1-4 respectively.

Precount [Measure] **[0...2]**

Specifies the pre-count that will occur before recording begins.

With a setting of 0, recording will begin the instant you press the SEQUENCER START/STOP button (after first pressing the SEQUENCER REC button).

✓ **0-6: Page Menu Commands**

- Compare →p.112
- Memory Status →p.521
- Exclusive Solo →p.113
- Rename Song →p.521
- Initialize Song →p.522
- Copy From Song →p.522
- Load Template Song →p.522
- Save Template Song →p.523
- FF/REW Speed →p.523
- Set Location (for Locate Key) →p.523
- GM Initialize →p.523
- Copy from Combi →p.525
- Copy From Program →p.525
- Stereo Pair →p.525
- Auto HDR/Sampling Setup →p.527
- Add To Set List →p.113
- Load required samples →p.114
- PAGE →p.126
- MODE →p.126

0-7: ARP DRUM



These settings are for the arpeggiator function in SEQUENCER mode.

You can use two arpeggiators (A and B) and a drum track or step sequencer in SEQUENCER mode.

Here we will configure the arpeggiator and drum track/step sequencer for each of the four scenes.

You can select a scene and then change the settings of the arpeggiator and drum track/step sequencer together. Refer to PROGRAM mode for the respective settings. For more information, see “0-6: ARP DRUM” on page 15.

While a song or pattern is playing, you can play in real time with the keyboard, the arpeggiator and the RPPR functionality.

- ⚠ The data recorded in a track cannot be input into the arpeggiator. Also, the note data recorded in a track cannot be used as a trigger to generate phrases and other notes with the arpeggiator.
- ⚠ The tempos of the song and arpeggiator function cannot be set individually.

Scene Common Setup

Drum MIDI Ch. [01...16, Tch]

This sets the MIDI channel used to transmit MIDI data from the drum track or step sequencer.

The drum track or step sequencer will play using the Program of the timbre that is set to the same MIDI channel.

Tch: The MIDI channel will automatically be set to the “MIDI Channel” (GLOBAL 1-1a) of the track selected in “Track Select” for output.

The “Status” setting of the timbre for the MIDI channel that matches the “Output” determines whether the pattern data is transmitted to an external device.

Scene Cue Mode

Select either “Immediately” or “Measure” for the timing to be used when you change scenes while they are playing.

Immediately: The scene will be changed right away once a new scene is selected.

Measure: After the new scene is selected, the scene will be changed upon moving to the next measure in the scene, or when the scene returns to the beginning.

Note: The length of a scene or its measures is determined by the arpeggiator or drum track/step sequencer settings in that scene. When the drum function is off, the scene length will be the length of the selected drum track or step sequencer. When the drum function is off, the length of the scene is used for the length of the arpeggiator.

Note: When the drum function is off and the arpeggiator pattern is set to the preset pattern, the “Immediately” setting will be used, since it does not have a length parameter.

More

Open the Scene Common Setup detailed settings dialog box.

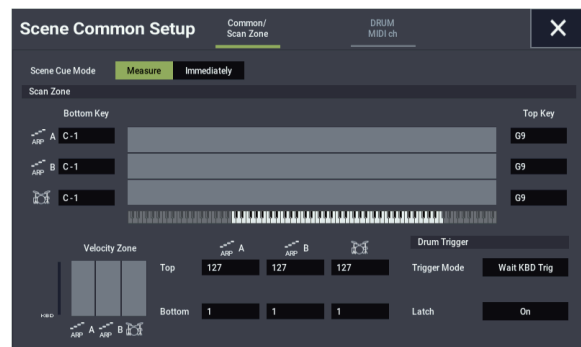

Common/Scan Zone:

Configures the respective settings for arpeggiators A and B. For more on the various parameters, refer to PROGRAM mode. For more information, see “Common/Scan Zone :” on page 16.

Input Ch [01...16, Tch]

Specifies the MIDI channel used to trigger the drum playing.

Tch: The MIDI channel will automatically be set to the “MIDI Channel” of the track selected in “Track Select” for triggering.

When “Trigger Mode” is set to “Wait KBD Trig” and the MIDI channel set here is selected in “Track Select” for the set track, the keyboard will trigger the arpeggiator. Also, the drum track will trigger the input from the MIDI IN of the matching MIDI channel.

DRUM MIDI ch:

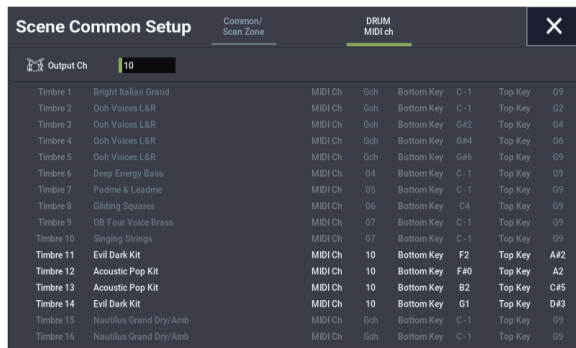

Output Ch [01...16, Tch]

This sets the MIDI channel used to transmit MIDI data from the drum track or step sequencer.

The drum track or step sequencer will play using the Program of the track that is set to the same MIDI channel.

Tch: The MIDI channel will automatically be set to the “MIDI Channel” of the track selected in “Track Select” for output.

The “Status” setting of the track for the MIDI channel that matches the “Output” determines whether the pattern data is transmitted to an external device.

Scene 1-4 Setup

Here we configure each of the arpeggiator and drum settings for each scene.

There are two arpeggiators (A and B) in SEQUENCER mode, and two arpeggio patterns can be used simultaneously.

Arpeggio Pattern [P0...P4, A0000...A2047, B000...B127]

Loop/1Shot

Latch

Drum Track/StepSeq select

Drum Track Pattern

More

Refer to PROGRAM mode for the respective settings. For more information, see “Scene 1-4 Setup” on page 18.

Input Ch [[01...16, Tch]

Sets the MIDI input channel for each arpeggiator.

Out of all MIDI data that is generated using the keyboard or transmitted from the MIDI IN connector, the MIDI data that matches the MIDI channel set here will be input to each arpeggiator.

Tch: The MIDI channel will automatically be set to the MIDI channel of the track selected in “Track Select”.

Output Ch [01...16, Tch]

Sets the MIDI output channel for each arpeggiator.

Out of the MIDI data transmitted from each arpeggiator, the tracks that match the MIDI channels you set here will sound. Also, the tracks in real-time recording that match the MIDI channel will record.

Tch: The MIDI channel will automatically be set to the MIDI channel of the track selected in “Track Select”.

Thru By ARP Switch Off [On, Off]

This sets whether the MIDI data received by each arpeggiator will be transmitted (sent through) to the timbre via the MIDI channel specified in “Output Ch”, when the arpeggiator function is off.

On (checked): When the arpeggiator function is off, the MIDI data received by each arpeggiator will be transmitted (sent through) to the timbre via the MIDI channel specified in “Output Ch”.

Off (unchecked): When the arpeggiator function is off, the MIDI data received by each arpeggiator will not be transmitted to the timbre.

Timbre Zone Bypass [Off, On]

For more information, see “Timbre Zone Bypass” on page 391.

Edit STEP SEQUENCE

For more information, see “Edit STEP SEQUENCE” on page 20.

0-7: Page Menu Commands

- Compare →p.112
- Memory Status →p.521
- Exclusive Solo →p.113
- Rename Song →p.521
- Initialize Song →p.522

- Copy From Song →p.522
- Load Template Song →p.522
- Save Template Song →p.523
- FF/REW Speed →p.523
- Set Location (for Locate Key) →p.523
- GM Initialize →p.523
- Copy from Combi →p.525
- Copy From Program →p.525
- Copy Scene →p.122
- Swap Scene →p.122
- Add To Set List →p.113
- Initialize Scene →p.122
- PAGE →p.126
- MODE →p.126

0-8: Sampling

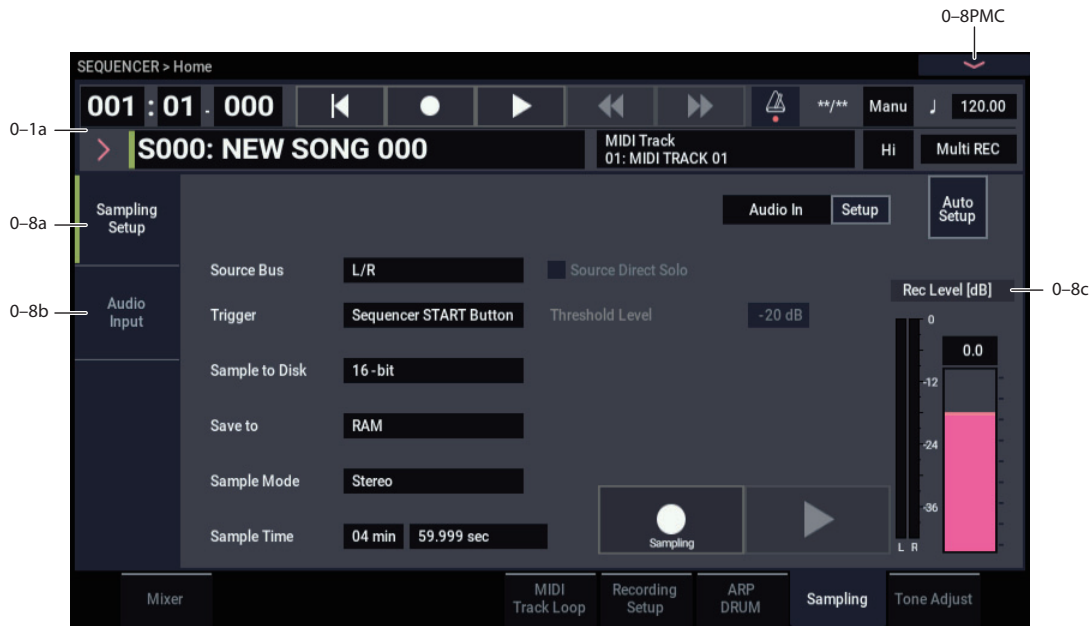

Here you can adjust the settings for the analog/digital audio signal input (AUDIO INPUT, USB), and the sampling-related settings for SEQUENCER mode.

In SEQUENCER mode, the external audio sources you specify here can be recorded to audio tracks or sampled. (You can also record or sample a song that’s played back by the NAUTILUS or your own playing on the keyboard.) You can also use the NAUTILUS as a 4-in/6-out effect processor.

! You can’t record a Song or pattern while sampling. Nor can you sample while recording a Song or pattern.

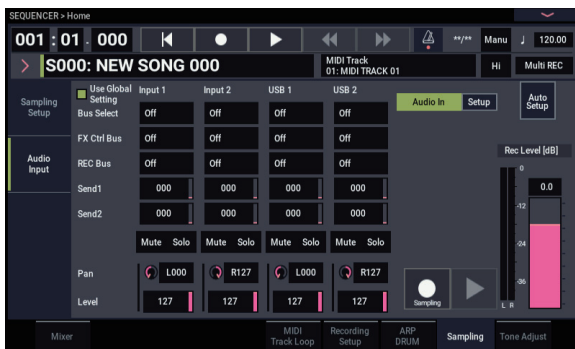

0-8a: Sampling Setup

Here you can select the source to be sampled, and the method by which to initiate sampling.

Except for **Trigger**, the following parameters are the same as in the PROGRAM > Home– Sampling - Sampling Setup page. For more information, see “0-8a: Sampling Setup” on page 22.

Sampling Setup settings are maintained not separately for each song, but as a single set in SEQUENCER mode.

Source Bus [Audio Input1/2, USB 1/2, L/R, REC1/2, REC3/4, Indiv.1/2, Indiv.3/4]

Source Direct Solo [Off, On]

Sample to Disk [16-bit, 24-bit]

Save to [RAM, Disk]

Sample Mode [L-Mono, R-Mono, Stereo]

Sample Time [min] [sec]

Trigger [Sampling START button, Note On, Threshold, Sequencer START button]

Specifies how sampling will be initiated.

Sampling START button: Pressing the SAMPLING REC button will cause the NAUTILUS to enter sampling-standby mode, and sampling will begin when you press the SAMPLING START/STOP button.

Note On: Press the SAMPLING REC button, and then press the SAMPLING START/STOP button to enter sampling-standby mode. Sampling will begin when you play the keyboard.

MIDI You can also initiate sampling by receiving a MIDI note-on message instead of playing the keyboard.

Threshold: Sampling will begin automatically when the input level exceeds the specified **Level** value. For more information, see “0-8a: Sampling Setup” on page 581.

Sequencer START button: Press the SAMPLING REC button and then the SAMPLING START/STOP button to enter sampling-standby mode. Then press the SEQUENCER START/STOP button to begin sampling. Use this when you want to resample the song playback.

To stop sampling, press the SAMPLING START/STOP button once again. Sampling will also end if you keep sampling until the time specified by “Sample Time.” For the procedure, see “Trigger” on page 582.

Threshold Level **[-63dB...00dB]**

When sampling with **Trigger** set to Threshold, this specifies the level at which sampling will begin. This can be set only when **Trigger** is set to Threshold. See step 3 of the **Trigger Threshold** procedure.

Sample to Disk **[16-bit, 24-bit]**

This sets the bit depth for sampling to drive. For more information, please see “Sample to Disk” on page 24.

0-8b: Audio Input

These parameters control the level, pan, play/mute and solo status, send levels, and bus assignments for each of the analog and digital inputs. For more information, see “0-8b: Audio Input” on page 26.

Use Global Setting **[Off, On]**

Each Song can either use the single, Global audio input mixer setup, or have its own custom settings. For more information, see “Use Global setting” on page 26.

Input 1 & 2

USB 1 & 2

Bus Select (IFX/Indiv. Out Assign)
[L/R, IFX1...12, 1...4, 1/2...3/4, Off]

FX Ctrl Bus (FX Control Bus) **[Off, 1, 2]**

REC Bus **[Off, 1...4, 1/2, 3/4]**

Send1 (to MFX1) **[000...127]**

Send2 (to MFX2) **[000...127]**

Play/Mute **[Play, Mute]**

Solo On/Off **[Off, On]**

Pan **[L000...C064...R127]**

Level **[000...127]**

These parameters configure the input source for analog/digital audio devices as well as the input level, pan, the various buses and the send level to the master effect. The “Input” settings here are enabled when “User Global Setting” is off.

These parameters are the same as those in the Audio Input page of the Home– Sampling page in PROGRAM mode. For more information, please see “0-8b: Audio Input” on page 26.

0-8c: Rec Level [dB]

These parameters are the same as in PROGRAM mode P0– Sampling. For more information, please see “Recording Level” on page 27.

 The final signal level when recording an audio track is set by the Home– Recording Setup page **Recording Level** setting.

ADC OVERLOAD !

Recording Level **[-Inf, -72.0 ... +0.0 ... +18.0]**

Level Meter

CLIP !

These parameters are the same as those in the Sampling Setup page of the Home– Sampling page in PROGRAM mode. For more information, please see “0-8c: Rec Level [dB]” on page 27.

The **Recording Level** setting applies to all of SEQUENCER mode, and is not saved with individual Songs.

✓ 0-8: Page Menu Commands

- Compare →p.112
- Memory Status →p.521
- Exclusive Solo →p.113
- Rename Song →p.521
- Initialize Song →p.522
- Copy From Song →p.522
- Load Template Song →p.522
- Save Template Song →p.523
- FF/REW Speed →p.523
- Set Location (for Locate Key) →p.523
- GM Initialize →p.523
- Copy from Combi →p.525
- Copy From Program →p.525
- Optimize RAM →p.114
- Select Sample No. →p.115
- Auto HDR/Sampling Setup →p.527
- Add To Set List →p.113
- PAGE →p.126
- MODE →p.126

0-9: Tone Adjust

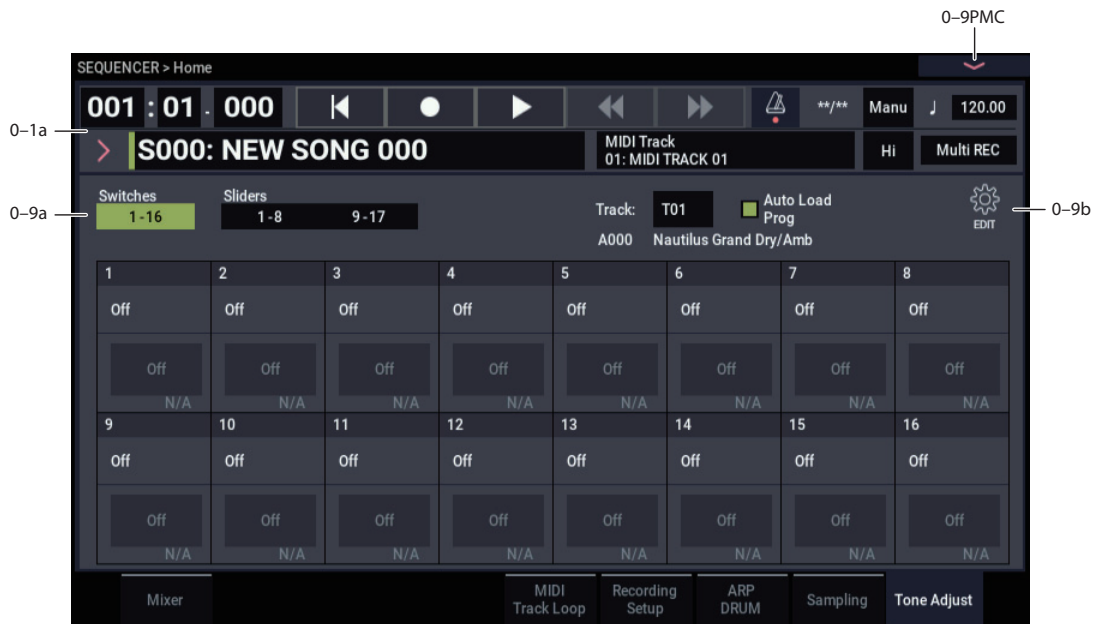

0-9a: Tone Adjust

Tone Adjust provides two important features simultaneously:

- It lets you use all of the sliders, and switches to control Program parameters - like the knobs on an analog synth, or the drawbars on an organ.
- It lets you modify Programs for use within a specific Song, including everything from subtle tweaks (like changing LFO speeds) to dramatic changes (such as selecting a different Multisample). Any changes that you make are stored with the Song, and do not alter the original Program.

Each of the sixteen Tracks has its own set of tone adjust parameters, but only one Track is shown at a time.

For more information, see:

- “Tone Adjust and MIDI SysEx” on page 30
- “Interaction between Tone Adjust and MIDI CCs” on page 30
- “Absolute, Relative, and Meta parameters” on page 30

Saving Tone Adjust Edits

In PROGRAM mode, when you make edits via Tone Adjust and then save the results, the Program data is changed—just as if you’d edited the internal parameters directly. For more information, see “Saving Tone Adjust Edits” on page 29.

In SEQUENCER mode, however, all Tone Adjust edits are stored within the Song; the Program itself is not changed. This lets you alter the way that a Program sounds in one specific Song without affecting the way that it sounds in PROGRAM mode, or in any other Combis or Songs.

Switches 1-16 button

Switches to the Switch page of Tone Adjust.

Sliders 1-8, 9-17 buttons

Switches to the Slider page of Tone Adjust.

Track select

Track [1...16]

This selects the Track whose Tone Adjust parameters appear on the screen. You can switch back and forth between the different Timbres as much as you like, without losing your edits.

Auto Load Prog [Off, On]

When you first load a Program into a Track, this parameter determines whether or not the Program’s Tone Adjust settings will be loaded as well.

These settings include the parameters assigned to each slider, and switch, along with the on/off state of any Switches assigned to Absolute parameters.

Note that any edits you’ve made using Tone Adjust in PROGRAM mode will already have been stored into the Program’s parameters. This means that the Program will still sound the same, whether or not you load the Tone Adjust settings.

Once the Program has been loaded, you can change any or all of the Tone Adjust settings as desired, including both assignments and values. All such edits are stored in the Song, without affecting the original Program.

If **Auto Load Prog** is **On**, Tone Adjust settings will be automatically loaded along with the Program.

If **Auto Load Prog** is **Off**, then the relationship between the types of the old and new Programs will determine what happens, as shown in the table below:

| If the old Program is... | And the new Program is... | Then Tone Adjust parameters and values are... |
|--------------------------|---|---|
| An HD-1 Program | An HD-1 Program | kept the same |
| An HD-1 Program | An EXi Program | loaded from the new Program |
| Any EXi Program | An HD-1 Program | loaded from the new Program |
| An EXi Program | An EXi Program with the same EXi assigned to the same slots as the previous Program | kept the same |
| An EXi Program | An EXi Program which does not use the same EXi as the previous Program | loaded from the new Program |

0-9b: Tone Adjust Edit

Press the  (EDIT) icon to edit the assignments and other settings for the Tone Adjust function.

Sliders 1-8, 9-17

Assign [List of Tone Adjust assignments]

This lets you assign a Tone Adjust parameter to the sliders.

The first group of parameters are the Common set, which are supported by most Program types. For a full list, see “Common Tone Adjust Parameters” on page 31.

After the Common parameters, the items in the list will vary depending on the Program type. For more information, please see:

“HD-1 Tone Adjust Parameters,” on page 32.

“AL-1: Tone Adjust,” on page 180.

“CX-3: Tone Adjust,” on page 203.

“STR-1: Tone Adjust” on page 251.

“MS-20EX Tone Adjust parameters” on page 280

“PolysixEX Tone Adjust parameters” on page 295.

Other EXi instruments will have their own set of parameters, as described in their manuals.

Assignments are exclusive

Each controller can be assigned to only one parameter, and each parameter can be assigned to only one controller.

To swap a parameter from one control to another, you’ll need to first un-assign it from the old control, and then assign it to the new control.

Value [Depends on parameter]

This shows the current value of the parameter. The range of values will vary depending on the parameter assigned to the control.

Switches 1-16

Tone Adjust switches act a little differently than sliders.

When a switch is assigned to a **Relative** parameter, or an **Absolute** parameter with more than two states:

Switch On = **On Value** (see below)

Switch Off = the Program’s stored value

When a switch is assigned to a two-state **Absolute** parameter, such as **Hold**, the switch status directly reflects the parameter value:

Switch On = **On**

Switch Off = **Off**

Assign [List of Tone Adjust assignments]

This lets you assign a Tone Adjust parameter to the switch. For more information, see “Assign,” above.

On Value [Depends on parameter]

The parameter is set to this value when the switch is On.

When the switch is assigned to a two-state **Absolute** parameter, such as **Hold**, this will always be the same as the **Switch Status** (see below).

Switch Status [Off, On]

This simply shows whether the switch is On or Off.

✓ 0-9: Page Menu Commands

- Compare →p.112
- Memory Status →p.521
- Exclusive Solo →p.113
- Rename Song →p.521
- Initialize Song →p.522
- Copy From Song →p.522
- Load Template Song →p.522
- Save Template Song →p.523
- FF/REW Speed →p.523
- Set Location (for Locate Key) →p.523
- GM Initialize →p.523
- Copy from Combi →p.525
- Copy From Program →p.525
- Add To Set List →p.113
- Copy Tone Adjust →p.436
- Reset Tone Adjust →p.436
- PAGE →p.126
- MODE →p.126

SEQUENCER > EQ/X-Y/Controllers

1-1: MIDI Track EQ



Each Track has a dedicated three-band EQ, with sweepable mid band. This page lets you view and adjust the settings for all 16 MIDI Tracks at once.

1-1a: Location, Song/Track Select

Location [001:01.000...999:16.479]

Song Select [000...199]

Track Select [MIDI Track01...MIDI Track16, Master Track, Audio Track01...Audio Track16]

RPPR [Off, On]

♩ (Tempo) [040.00...300.00, EXT]

For more information, please see “0-1a: Location, Song/Track Select” on page 443.

1-1b: Selected Track Info



This page displays information about the track that’s selected for editing. If you’ve selected a MIDI track, this shows the bank type, T: MIDI track number/program bank/number/name, Ch: MIDI channel number, RPPR (Assign): the key number that starts the RPPR assigned to the track, and KBD: the bank/number/name of the program that will sound when you play the keyboard.

If you’ve selected an audio track, this shows the AT: audio track number/region number and name of the first audio event, [STEREO]: Stereo Pair on/off status, and KBD: the bank/number/name of the program that will sound when you play the keyboard.

RPPR (Assign) will not show all of the RPPR assignments if there are many of them. You can use the Pattern Edit page to see all of the RPPR assignments.

Track Number

This indicates the MIDI track number. The various parameters below each track number make settings for the corresponding track.

Track Category

This shows the abbreviated category name of the Program assigned to the Track.

Track 01 (Track Number)

Auto Load Prog EQ [Off, On]

When you first load a Program into a Track, this parameter determines whether or not the Program’s EQ settings will be loaded as well.

Once the Program has been loaded, you can change any or all of the EQ settings as desired. All such edits are stored in the Combination, without affecting the original Program.

Regardless of this setting, subsequent edits to the Program’s EQ in PROGRAM mode will not affect the Combination.

On: the Program’s EQ settings will be loaded automatically along with the Program. This is the default setting.

Off: the Program’s EQ settings won’t be loaded. Use this if you’ve set up the EQ in a specific way, and then want it to stay unchanged while you try out different Programs.

Bypass [Off, On]

If this is **On (checked)**, all of the EQ will be disabled, including “Input Trim.” Bypass can be convenient for comparing the results of the EQ with the original signal.

Input Trim [00...99]

This controls the volume level going into the EQ. Note that this parameter uses a linear scale; 50 is equivalent to -6dB, 25 is the same as -12dB, and so on.

High settings of the Low, Mid, and High Gain controls can cause substantial increases in the overall level. You can compensate for this by turning down the input trim.

The meter to the left of the parameter shows the post-EQ signal level in realtime.

High Gain [-18.0...+18.0dB]

This controls the gain of the 10kHz High Shelf EQ, in increments of 0.5dB.

Mid Frequency [100Hz...10.00kHz]

This sets the center frequency for the Mid sweep EQ.

Mid Gain [-18.0...+18.0dB]

This controls the gain of the Mid Sweep EQ, in increments of 0.5dB.

Low Gain [-18.0...+18.0dB]

This controls the gain of the 80Hz Low Shelf EQ, in increments of 0.5dB.

Track 02...16 (Track Number)

These parameters adjust the three-band EQ (with sweepable mid range) for MIDI tracks 2 through 16. They are the same as for track 1. See "Track 01".

✓ 1-1: Page Menu Commands

- Compare →p.112
- Memory Status →p.521
- Exclusive Solo →p.113
- Rename Song →p.521
- Initialize Song →p.522
- Copy From Song →p.522
- Load Template Song →p.522
- Save Template Song →p.523
- FF/REW Speed →p.523
- Set Location (for Locate Key) →p.523
- GM Initialize →p.523
- Copy from Combi →p.525
- Copy From Program →p.525
- Show EQ Graphic →p.436
- Stereo Pair →p.525
- PAGE →p.126
- MODE →p.126

1-2: Audio Track EQ

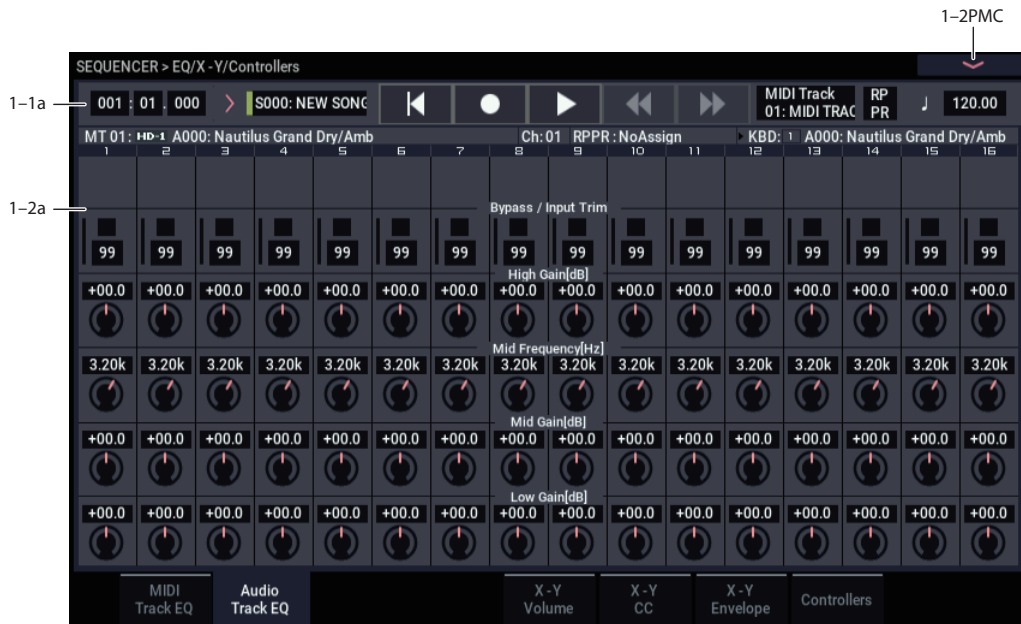

Here you can adjust the three-band EQ (with sweepable mid range) for audio track.

1-2a: 3 Band Parametric EQ

Track 01...16 (Track Number)

STEREO

This is shown if **Stereo Pair** is on.

Bypass [Off, On]

Input Trim [00...99]

High Gain [-18.0...+18.0dB]

Mid Frequency [100Hz...10.00kHz]

Mid Gain [-18.0...+18.0dB]

Low Gain [-18.0...+18.0dB]

Here you can adjust the mid-sweepable three-band EQ for audio tracks 1-16. For more information, please see “1-1b: Selected Track Info” on page 466.

Recording the Audio Track EQ

The “Bypass,” “Input Trim,” “High Gain,” “Mid Frequency,” “Mid Gain,” and “Low Gain” settings you make here are used when you play back or record from the beginning of the song. If settings other than “Bypass” are modified during recording, the changes are recorded to each audio track as automation event data, and these changes will be reproduced during playback.

You can also modify the settings during playback. However if you’ve recorded EQ data, the settings will change according to the recorded data.

✓ 1-2: Page Menu Commands

- Compare →p.112
- Memory Status →p.521
- Exclusive Solo →p.113
- Rename Song →p.521
- Initialize Song →p.522
- Copy From Song →p.522
- Load Template Song →p.522
- Save Template Song →p.523
- FF/REW Speed →p.523
- Set Location (for Locate Key) →p.523
- GM Initialize →p.523
- Copy from Combi →p.525
- Copy From Program →p.525
- Show EQ Graphic →p.436
- Stereo Pair →p.525
- PAGE →p.126
- MODE →p.126

1-5: X-Y Volume



Vector Synthesis lets you control Track volumes and Program & Effects parameters by using the programmable X-Y Envelope, or by the combination of the two.

For more background information on Vector Synthesis, please see “What does Vector mean?” on page 41, and “X-Y Volume and CC control use separate X-Y Envelopes” on page 474.

Program and Song Vectors work together

In SEQUENCER mode, each Track’s Program still has its own X-Y Envelope, which controls volume and CCs as it did in PROGRAM mode. You can disable the Program X-Y Volume and CC control separately for each Track, if desired.

There is also a separate Song-wide X-Y Envelope, with its own X-Y Volume and CC control settings. As with the Program X-Y, you can disable the Song Volume and CC control separately for each Track. Note that the Song X-Y CCs affect only Tracks and Effects on the Global MIDI Channel.

How SEQUENCER mode X-Y Volume works

In PROGRAM mode, X-Y Volume fades between the two Oscillators. Oscillator 1 is always at maximum volume when the X-Y position is all the way to the left (–X), and Oscillator 2 is always at maximum when the X-Y Position is all the way to the right (+X).

In SEQUENCER mode, on the other hand, the Vector can fade between any or all of the 16 Tracks. You can assign each of the Tracks to be controlled by any of the four X-Y axes (+X, –X, +Y, –Y), or to not be controlled at all.

This lets you set up complex transitions between different Programs, including between HD-1 and different EXi instruments.

1-5a: X-Y Volume Control

X-Y Volume Control lets you adjust the relative volumes of the 16 Tracks by moving the X-Y Envelope from left to right on the X axis, and up and down on the Y axis.

The **Equal Amount** check-box makes the Vector create a smooth fade between the Tracks, while the individual Track **Center Volume** parameters allow you to create more complex fade shapes.

Enable Volume Control [Off, On]

When this box is checked, the X-Y position will control the volumes of all Tracks whose **X-Y Assign** parameter is not set to **Off**.

When this box is not checked, the X-Y position will not directly affect volume. However, it’s still possible for the Vector to control volume via X-Y CCs and AMS, depending on the individual Program’s parameter settings.

Equal Amount [Off, On]

This applies only when **Enable Volume Control** is **On**.

When **Equal Amount** is **On**, the Vector will fade between all four X-Y axes while maintaining a total amount of 100%. This provides a smooth fade between the different sounds, and is the type of volume control used by classic vector synths.

Note that this will work best when the Programs assigned to each of the four axes have equivalent volumes. For instance, you might create a Song with four Programs, each sounding at the same volume and assigned to a different axis. You could then add a fifth Program, assign it to one of the axes, and then reduce the volumes of both Programs on that axis by 50%—so that their combined volume is the same as any one of the other Programs.

Also, when this is checked, the **Center Volume** parameters will be grayed out, since **Equal Amount** sets them automatically.

SEQUENCER mode

When **Equal Amount** is **Off**, the individual Track **Center Volume** parameters determine the way in which X-Y position affects volume.

Note: For an interesting variation on this effect, turn **Equal Amount Off**, and instead set all of the Track **Center Volumes** to **50%**. The Tracks will still fade together smoothly, but with a more gentle effect towards the extremes of the Vector axes.

Vector Synthesis system, SEQUENCER mode

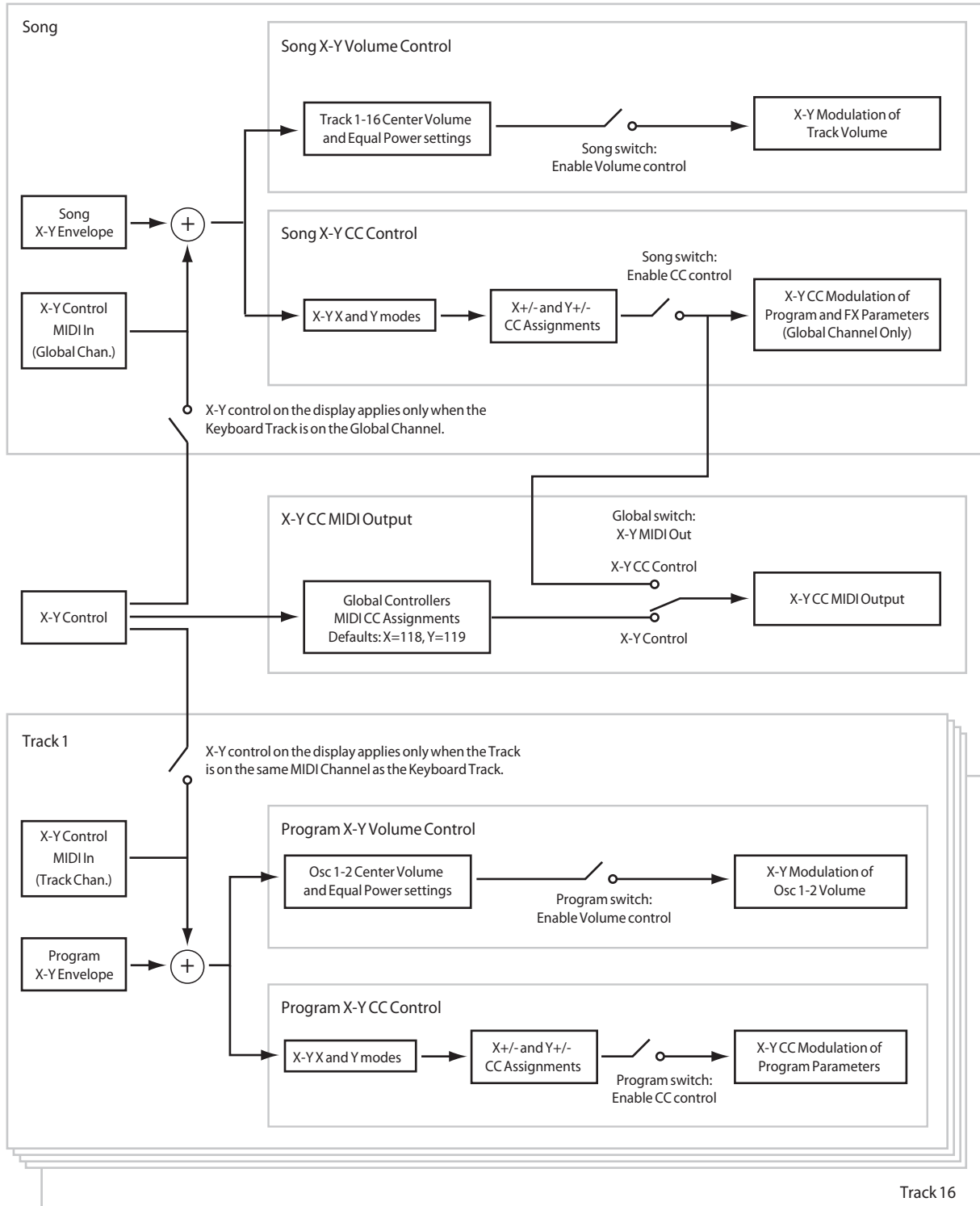

1-5b: X-Y Graphic

X-Y Graphic

This shows a diagram of the vector space, including the five points of the X-Y Envelope (labeled 0-4).

The transitions between the X-Y Envelope's points are shown by black lines, and the loop transition is shown by a gray line.

Show Volume Image [Off, On]

The X-Y graphic includes an image representing the X-Y Volume Control settings for the current Track (see **Track Select**, below). You can use the **Show Volume Image** checkbox to toggle this part of the graphic on and off.

Track Select [01...16]

This selects the Track whose volume image will be shown.

Show Point [X-Y Control, X-Y Envelope Point 0...4]

You can view the volume and CC values for any of the EG's five points. This selects the point whose values will be shown.

Track Volume & CC Display

This read-only display shows the volume and CC values for the current X-Y point, as selected by the Show Point parameter, above.

Track 01

X-Y Assign [Off, +X, -X, +Y, -Y]

This assigns an axis of the Vector to control the Track's volume. See the diagram "X-Y Assign and Program Volume," below, for more details.

Off means that the X-Y position will not affect the Track's volume.

X-Y Assign and Program Volume

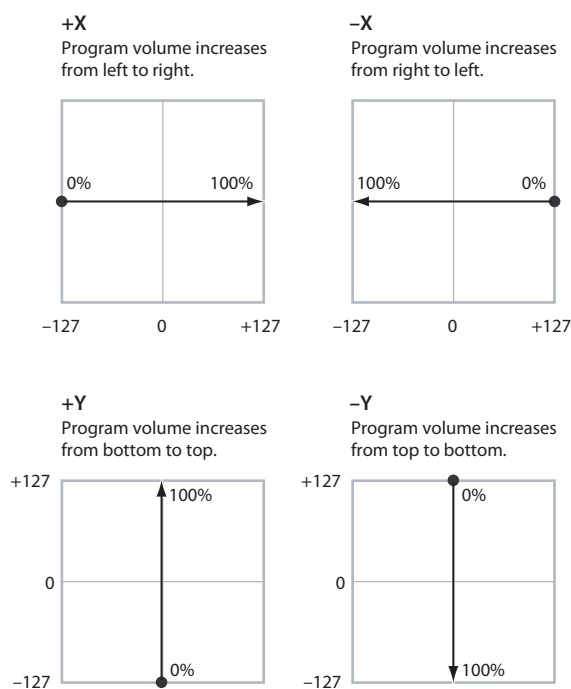

Center Volume [0, 25, 50, 75, 100%]

This sets the volume of Track 1 at the center point. It applies only when **Equal Amount**, above, is set to **Off**.

The volumes at the extreme ends of the axis are fixed, depending on the setting of the **X-Y Assign** parameter.

For instance, if **X-Y Assign** is set to **-X**, the Track will always be at 100% volume on the left side, and 0% (silent) on the right side.

This parameter applies only to the Song X-Y Volume control, and does not change the Program's individual X-Y Volume settings.

Track Center Volume, X-Y Assign = -X

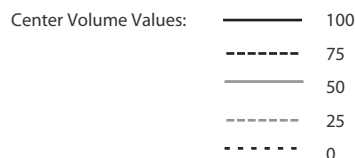
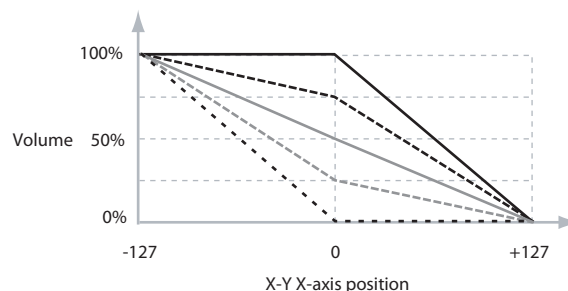

Enable Program X-Y Volume [Off, On]

When this is turned **On**, the Program's X-Y Volume control will function as it does in PROGRAM mode, crossfading between Oscillators 1 and 2. The crossfade will be controlled by the Program's X-Y Envelope and is not affected by the Song's X-Y Envelope.

When this is turned **Off**, the Program's X-Y Volume control will be disabled.

Tracks 02-16

The parameters for Tracks 2-16 are identical to those for Track 01, as described above.

✓ 1-5: Page Menu Commands

- Compare →p.112
- Memory Status →p.521
- Exclusive Solo →p.113
- Rename Song →p.521
- Initialize Song →p.522
- Copy From Song →p.522
- Load Template Song →p.522
- Save Template Song →p.523
- FF/REW Speed →p.523
- Set Location (for Locate Key) →p.523
- GM Initialize →p.523
- Copy from Combi →p.525
- Copy From Program →p.525
- PAGE →p.126
- MODE →p.126

1-6: X-Y CC



1-6a: X-Y CC Control

X-Y CC Control lets you use the X-Y Envelope to control the Song’s Effects.

Each of the four directions of the Vector can send a different MIDI CC, including left (–X), right (+X), up (+Y), and down (–Y). You can choose between several different patterns combining these four directions by using the X-Y X Mode and X-Y Y Mode parameters.

The X-Y CCs are also sent to all Global Channel Tracks. These may modulate Program parameters, like any other MIDI CCs, depending on the settings within each individual Program.

Finally, you can optionally send these CCs out to external MIDI instruments. A global parameter allows you to enable or disable this MIDI output; by default, it is disabled.

Program and Song Vectors work together

In SEQUENCER mode, each Track’s Program still has its own X-Y Envelope which controls volume and CCs as it did in PROGRAM mode. You can disable the Program’s X-Y Volume and CC control separately for each Track, if desired.

Program X-Y CCs affect only their own Program, even if other Tracks are set to the same MIDI channel.

There is also a single, separate X-Y Envelope for the entire Song, with its own X-Y Volume and CC control settings. Song X-Y CCs affect all Tracks set to the Global channel. As with the Program X-Y, you can disable the Song Volume and CC control separately for each Track.

Vector and MIDI

The Vector features interact with MIDI through the X-Y CC Control.

The **X-Y CC Control** is generated by the X-Y position. Normally, this will only affect internal sounds and effects. If you like, however, you can also enable a Global parameter to send these generated CCs to external MIDI devices.

Note that, in SEQUENCER mode, only the Song’s X-Y CCs can be sent to external MIDI instruments; the individual Program’s X-Y CCs are only used internally.

Enable CC Control [Off, On]

When this box is checked, the X-Y position will send the CCs assigned to +X, –X, +Y, and –Y, as set below. Note that the Song X-Y CCs affect only Tracks and Effects on the Global MIDI Channel.

When this box is not checked, the X-Y position will not affect these CCs. However, the joystick will still send and receive its dedicated MIDI CCs, just like other physical controllers. See “Vector and MIDI,” above, for more information.

This parameter affects only the Song X-Y CCs. Even if this is turned **Off**, the individual Programs’ X-Y CCs will still function normally.

X-Y X Mode [Positive, Negative, Xfade, Split]

You can set up the Vector to send out CCs in several different patterns, as shown in the graphic below. This controls the pattern for the X axis.

Note that this setting affects only CC Control; it has no effect on Volume Control. Also, it applies only to the Song’s X-Y CCs, and has no effect on the individual Program X-Y CCs.

Positive sends out only +X, starting at 0 at the far left, and increasing to 127 at the far right. –X is disabled in this mode.

Negative sends out only –X, starting at 0 at the far right, and increasing to 127 at the far left. In this mode, +X is grayed out.

Xfade sends out both +X and –X, overlapping throughout the X axis. As one increases, the other decreases.

Split sends out both +X and –X, with a split in the center. +X is sent when the point moves to the right of the center, and –X is sent when the point moves to the left of center.

+X [Off...MIDI CC#119]

This assigns the controller sent by the +X X-Y. You can use this as an AMS source to control Program parameters, or as a Dmod source to control Effects parameters. It will be grayed out if the X-Y X Mode, above, is set to Negative.

In addition to the standard list of MIDI controllers, you can also assign the +X X-Y to duplicate the function of several front-panel controllers, including JS X, JS+X, JS-X, Knobs 1–6, and SW 1–2.

For instance, if you assign +X to Knob 6, the X-Y's +X will use the controller assigned to Knob 6 on the EQ/X-Y/Controllers– Controllers page.

Finally, you can also assign +X to control the Master Volume.

–X [Off...MIDI CC#119]

This assigns the controller sent by the –X X-Y. It will be grayed out if the X-Y X Mode, above, is set to Positive.

The selections are the same as for +X, above.

X-Y Y Mode [Positive, Negative, Xfade, Split]

This controls the X-Y CC pattern for the Y axis. For more information, see the description under X-Y X Mode, above.

+Y [Off...MIDI CC#119]

This assigns the controller sent by the +Y X-Y. It will be grayed out if the X-Y Y Mode, above, is set to Negative.

The selections are the same as for +X, above.

–Y [Off...MIDI CC#119]

This assigns the controller sent by the –Y X-Y. It will be grayed out if the X-Y Y Mode, above, is set to Positive.

The selections are the same as for +X, above.

X-Y CC Modes

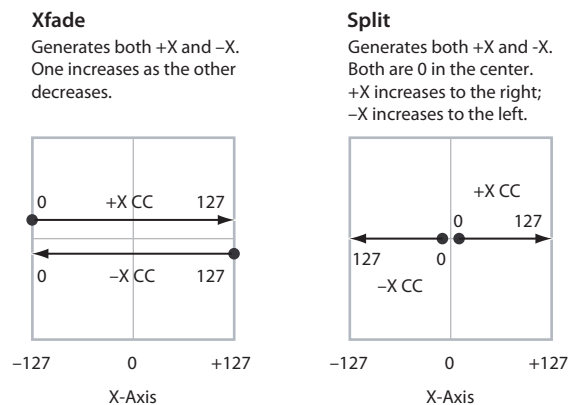
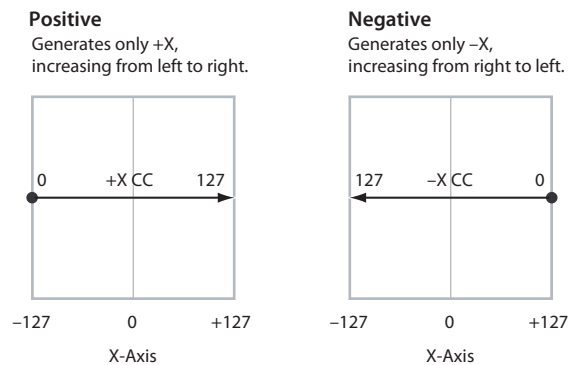

Show Point [X-Y Control, X-Y Envelope Point 0...4]

You can view the volume and CC values for any of the EG's five points. This selects the point whose values will be shown.

CC at Show Point [%]

This read-only display shows the volume values for the current X-Y point, as selected by the Show Point parameter, above.

Track 01

Enable Song X-Y CC [Off, On]

This controls whether or not the Track will receive the Song's X-Y CCs.

If this is **On**, the Track will receive the CCs, and the Track's Program will respond to them according to its own AMS settings.

If this is **Off**, the Track will not receive the CCs. This can be useful if the Song's X-Y CCs are causing unwanted modulation, or conflicting with the Program's own X-Y CCs.

Enable Program X-Y CC [Off, On]

This controls whether or not the Program's own X-Y CCs will be active.

If this is **On**, the Program's X-Y CCs and X-Y Envelope will work as AMS sources, just as they did in PROGRAM mode. The CCs will not affect any other Tracks, even if they are set to the same MIDI channel.

Note that, in some cases, the X-Y CCs may have been used for modulating the Program's effects via Dmod. This functionality is not carried into the Song; for modulating the Song's effects, use the Song's X-Y CCs instead.

If this is **Off**, then the Program's X-Y CCs will have no effect. This can be useful if they are conflicting with the Song's X-Y CCs.

Tracks 02–16

The settings for Tracks 2–16 are identical to those for Track 01, as described above.

✓ 1–6: Page Menu Commands

- Compare →p.112
- Memory Status →p.521
- Exclusive Solo →p.113
- Rename Song →p.521
- Initialize Song →p.522
- Copy From Song →p.522
- Load Template Song →p.522
- Save Template Song →p.523
- FF/REW Speed →p.523
- Set Location (for Locate Key) →p.523
- GM Initialize →p.523
- Copy from Combi →p.525
- Copy From Program →p.525
- PAGE →p.126
- MODE →p.126

1-7: X-Y Envelope



The X-Y Envelope works to control the X-Y position. It's particularly convenient for modulating effects, since it's the only programmable modulation source stored with the Song, outside of ARP.

The X-Y Envelope is different from the other envelopes in several ways:

- Each point has two “levels” - one for the X axis, and one for the Y axis.
- The envelope times can be based on seconds and milliseconds, or synced to tempo.
- Each point has a hold time, as well as a transition time to the next point.
- The envelope can loop between two points, for either a specified number of repeats, or as long as you hold the note.

X-Y Volume and CC control use separate X-Y Envelopes

There are actually two different X-Y Envelopes, which share the same parameters: one for Volume Control, and the other for CC Control.

All of the notes on the Song's Global Channel share a single CC Control X-Y Envelope. This EG starts when you first play a note, and continues as long as any notes are held down on the keyboard. When you release all of the notes, the EG goes into its release phase.

Each note then has its own, additional Volume Control X-Y Envelope, which lets you crossfade between Programs to create complex, evolving timbres. The **Key Sync** parameter applies only to this per-note EG.

When the **Key Sync** parameter is **Off**, the CC Control and Volume Control EGs are completely synchronized.

When **Key Sync** is **On**, each note's Volume Control EG will start at note-on, and go into release at note-off. All the notes will still share a single CC Control EG.

1-7a: Basic

Refer to PROGRAM mode for the respective settings.

1-7b: X-Y Envelope Loop

The X-Y Envelope can loop between two points, and can continue to loop either for as long as you hold the note, or for a specified number of repeats. You can also turn the loop off completely, if you like.

Refer to PROGRAM mode for the respective settings.

1-7c: X-Y Envelope

The X-Y Envelope has a total of five points. Since the X-Y Envelope can loop, the points are labeled differently from standard envelopes; instead of names like attack and decay, they are simply numbered 0-4.

Refer to PROGRAM mode for the respective settings.

✓ 1-7: Page Menu Commands

- Compare →p.112
- Memory Status →p.521
- Exclusive Solo →p.113
- Rename Song →p.521
- Initialize Song →p.522
- Copy From Song →p.522
- Load Template Song →p.522
- Save Template Song →p.523
- FF/REW Speed →p.523
- Set Location (for Locate Key) →p.523
- GM Initialize →p.523
- Copy from Combi →p.525
- Copy From Program →p.525
- Copy X-Y Envelope →p.119

- PAGE →p.126
- MODE →p.126

1-8: Controllers

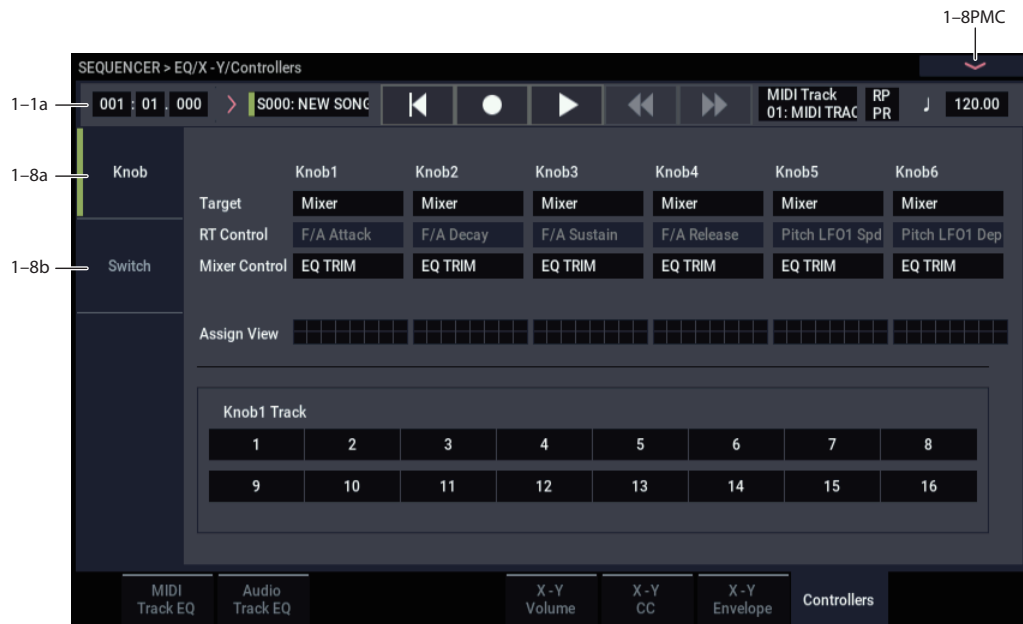

Here you can set the Sequencer functions of the SW1 button, SW2 button, and the RT control knobs 1–6. These settings are made independently for each song.

When you operate these buttons and knobs during recording, the MIDI messages assigned to them will be recorded.

1-8a: Knob

Here you can assign the function of the RT control knobs 1 through 6. Most of the functions that can be assigned are control changes. For more information, please see “RT Control Knobs 1–6 Assignments” on page 916.

The functions you assign here are performed when you select USER by using SELECT button and operate RT control knobs 1 through 6. For more information, please see “1-8a: RT Control Knob Assign” on page 48.

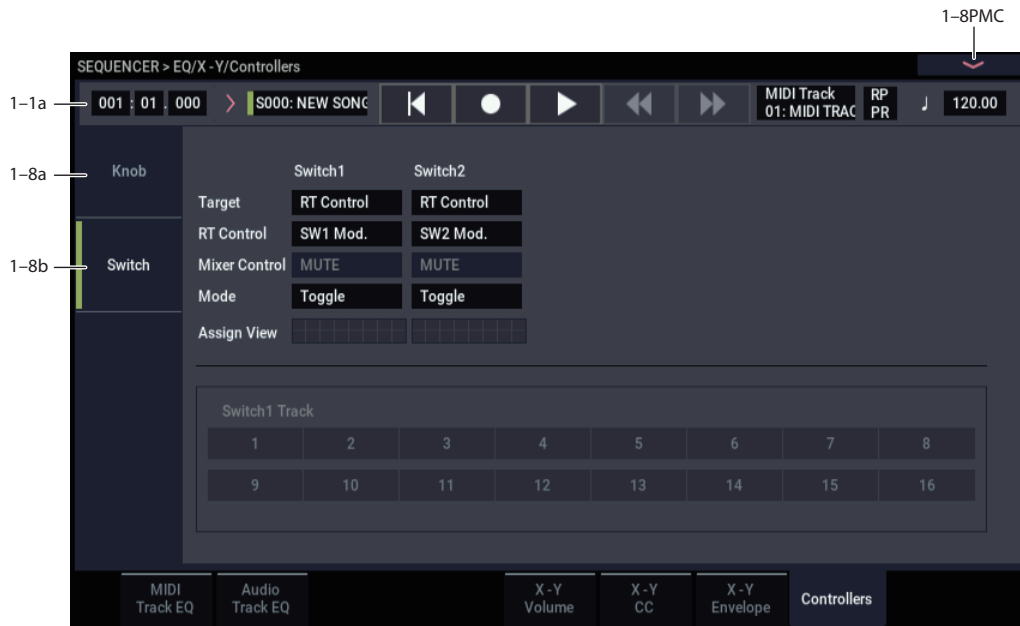

1-8b: Sw

Here you can assign the function of the SW1 and SW2 buttons. For details on the functions that can be assigned, see “SW1/2 Assignments” on page 915.

Since the assignable panel switch functions of the program assigned to each track are ignored, you can make new settings here.

SW1

Target [RT Control, Mixer]

RealTime Control [Off, ..., Soft (CC#67)]

Assigns a function to the SW1 button. The on/off status can also be saved. When you change the assigned function, the status will be reset to off.

Mixer Control [PLAY/MUTE, SOLO]

Mode [Toggle, Momentary]

Specifies the on/off action that occurs when you press the SW1 button.

Toggle: The function will alternate between on and off each time you press the SW1 button.

Momentary: The function will be on only while you continue holding down the SW1 button.

Assign View

When the Target is “Mixer”, this selects the mixer channel to control. You can select multiple channels.

SW2

Assigns a function to the SW2 button. The functions you can assign to the SW2 button are the same as for the SW1 button with the exception than SW1 Mod.:CC#80 is replaced by SW2 Mod.:CC#81.

✓ 1-8: Page Menu Commands

- Compare →p.112
- Memory Status →p.521
- Exclusive Solo →p.113
- Rename Song →p.521
- Initialize Song →p.522
- Copy From Song →p.522
- Load Template Song →p.522
- Save Template Song →p.523
- FF/REW Speed →p.523
- Set Location (for Locate Key) →p.523
- GM Initialize →p.523
- Copy from Combi →p.525
- Copy From Program →p.525
- PAGE →p.126
- MODE →p.126

SEQUENCER > Track Parameters

2-1: MIDI

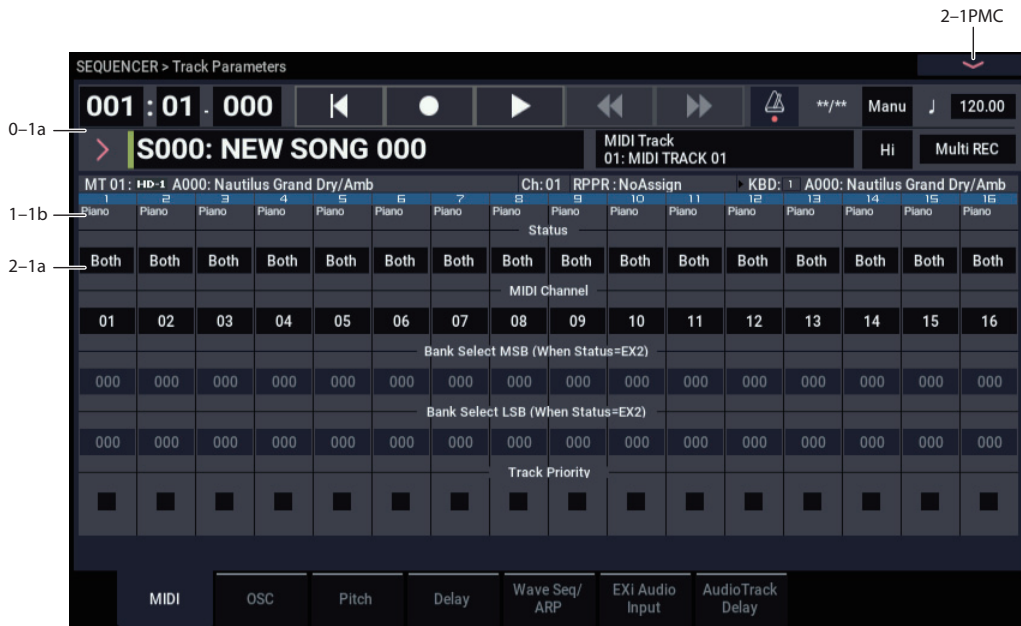

Here you can make MIDI-related settings for each MIDI track.

2-1a: MIDI

Track 01 (Track Number)

Status [Off, INT, Both, EXT, EX2]

This sets whether the Track controls the internal sounds, external MIDI devices, or both.

When controlling external MIDI devices, it also allows you to choose between using the internal Bank Select numbers (as set by the front-panel buttons), or using custom Bank Select settings to match the external device.

Off: Use this to disable the Track. With this setting, the Track's Program will not sound, and MIDI data will not be transmitted. Also, any EXi fixed resources used by the Program will be freed.

INT: When the musical data recorded in the MIDI track is played back, or when you use **Track Select** (0-1a) to select a MIDI track that is set to INT and play the keyboard and operate the controllers, the internal tone generator of the NAUTILUS will sound, and MIDI data will not be transmitted to an external device.

Both: The operation of both INT and EXT will be performed. When the musical data recorded in the MIDI track is played back, or when you select a MIDI track that is set to Both and play the keyboard and operate the controllers, the internal tone generator of the NAUTILUS will sound, and at the same time MIDI data will also be transmitted to an external device.

EXT: When the musical data recorded in the MIDI track is played back, or when you select a MIDI track that is set to EXT and play the keyboard and operate the controllers, MIDI data will be transmitted to an external device, but the internal tone generator of the NAUTILUS will not sound.

When you select another song or return to the beginning of the song, the program change, volume, panpot, portamento, sends 1 and 2, post IFX pan, and post IFX sends 1 and 2 of each MIDI track set to EXT will be transmitted via MIDI.

EX2: This enables you to specify a particular MIDI Bank Select message for the Track, instead of automatically using the Bank of the selected NAUTILUS Program. Use the parameters below, labeled **Bank Select MSB and LSB (When Status =EXT2)**, to set the Bank Select message as desired. In other respects this is the same as EXT, described above.

MIDI MIDI data is transmitted and received on the MIDI channel that is specified separately for MIDI track by "MIDI Channel."

| Status | Keyboard, Sequencer, & MIDI In play Internal Sounds | Keyboard & Sequencer Transmit MIDI Out |
|--------|---|---|
| OFF | No | No |
| INT | Yes | No |
| EXT | No | Yes (using the Bank Select message of the track's Program) |
| EX2 | No | Yes (using the Bank Select message specified on the MIDI tab of the Track Param page) |
| Both | Yes | Yes |

MIDI Channel [01...16]

Specifies the MIDI channel that the MIDI track will use to transmit and receive musical data. The MIDI channel you specify here will be the receive channel when **Status** is INT, the transmit channel when it is EXT or EX2, and the receive/transmit channel when it is Both. Tracks set to INT which have the same MIDI channel will sound and be controlled identically when they receive MIDI data or data from the sequencer tracks.

Bank Select MSB (When Status=EX2) [000...127]

Bank Select LSB (When Status=EX2) [000...127]

When **Status** is set to EX2, this sets the bank number that will be transmitted. When **Status** is other than EX2, this setting has no effect.

Track Priority [Off, On]

This lets you protect a Track's voices from being stolen by other, non-priority Tracks.

If a new note-on would exceed the available number of voices, one or more currently-sounding voice will be stopped ("stolen") to make room for the new voice. If **Track Priority** is **On**, then the Track's voices can only be stolen by other priority voices; all voices with **Track Priority Off** will be stolen first.

In a Song with many active Tracks, you can enable **Track Priority** for sounds with an important musical role, such as drums or bass. In general, you can enable it for any Track for which note stealing would adversely affect the overall sound.

Important: this setting will have little meaning if it is turned on for more than a few Tracks. It's a good idea to start with **Track Priority** un-checked for all Tracks, and only turn it on as necessary.

On (checked): The Track's voices will be given priority in voice-stealing.

Off (un-checked): The Track's voices will not be given priority in voice-stealing.

Track 02... 16 (Track Number)

These are the MIDI-related settings for MIDI tracks 2 through 16. They are the same as for track 1. See "Track 01"..

✓ **2-1: Page Menu Commands**

- Compare →p.112
- Memory Status →p.521
- Exclusive Solo →p.113
- Rename Song →p.521
- Initialize Song →p.522
- Copy From Song →p.522
- Load Template Song →p.522
- Save Template Song →p.523
- FF/REW Speed →p.523
- Set Location (for Locate Key) →p.523
- GM Initialize →p.523
- Copy from Combi →p.525
- Copy From Program →p.525
- PAGE →p.126
- MODE →p.126

2-2: OSC

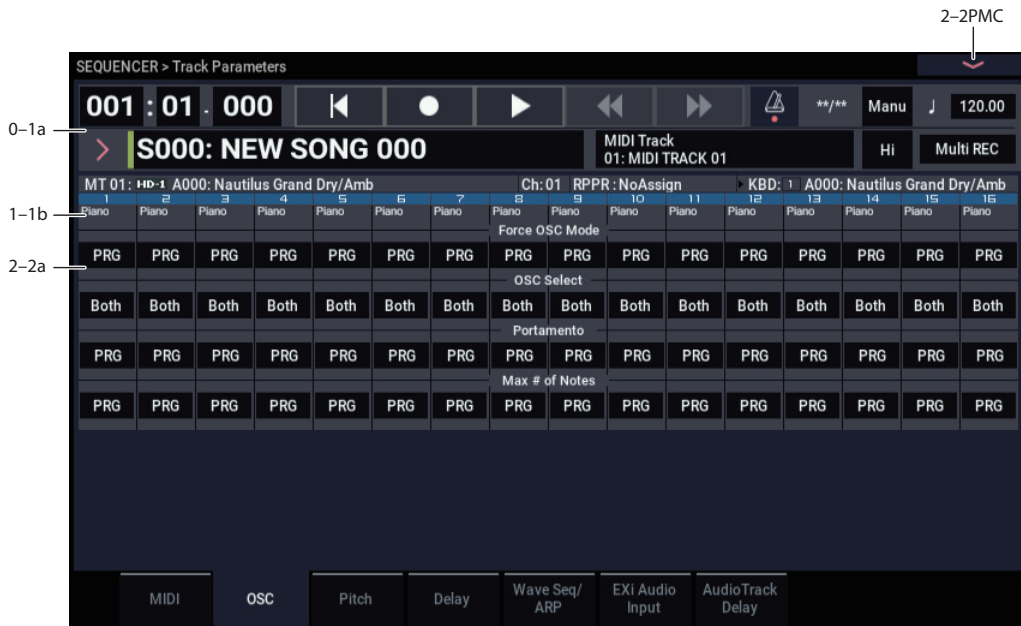

These parameters specify how each MIDI track will be sounded.

2-2a: OSC

Track 01 (Track Number)

Force OSC Mode [PRG, Poly, Mono, Legato]

This lets you override the Program's stored Voice Assign Mode settings, if desired.

For more information, please see "Force OSC Mode" on page 406.

OSC Select [Both, OSC1, OSC2]

Specifies whether the MIDI track's program will play OSC1/EXi1, OSC2/EXi2, or both.

For HD-1 programs whose **Oscillator Mode** (PROGRAM 1-1b) is Double, this setting lets you specify that only OSC1 or OSC2 will sound. For EXi programs which use two EXi instruments, this setting lets you specify that only EXi1 or EXi2 will sound. For more information, please see "OSC Select" on page 406.

Portamento [PRG, Off, 001...127]

Make portamento settings for each MIDI track. For more information, please see "Portamento" on page 406.

The portamento setting you make here will be used when the song is played or recorded from the beginning. If you change the setting while recording, it will be recorded as part of the musical data. (However if you set this to PRG, it will not be recorded.) You can change this setting during playback. However if you come to any Portamento On/Off data or Portamento Time data that was recorded, the settings will change accordingly.

When the track whose **Status** (2-1a) is INT or Both, MIDI control change CC#5 (Portamento Time) and CC#65 (Portamento Switch) can be received to control this and change the setting. (If the setting is PRG, CC#05 Portamento Time will not be received.)

When you switch songs or return to the beginning of the song, tracks whose **Status** is Both, EXT, or EX2 will transmit this setting via MIDI. If this is Off, CC#65 with a value of 0 will be transmitted. If this is 001-127, a CC#65 of 127 and CC#05 of 1-127 will be transmitted.

If this is set to PRG, nothing will be transmitted.

This data is transmitted and received on the MIDI channel specified for each track by **MIDI Channel** (2-1a).

Max # of Notes [Dynamic, 1...16]

Dynamic is the default. With this setting, you can play as many notes as the system allows.

1-16 lets you limit the maximum number of notes played by the Track. Voices will still be allocated dynamically, up to this maximum number. You can use this to:

- Model the voice-leading of vintage synthesizers, such as the Polysix
- Control the resources required by the Track, so that more voices can play on other Tracks

Max # of Notes applies only when the Program's **Voice Assign Mode** is set to **Poly**, or when **Force Osc Mode** has been set to **Poly**. With **Mono**, it has no effect.

This setting does not limit the **Unison Number of Voices**. For instance, if **Max # of Notes** is set to **6**, and **Unison Number of Voices** is set to **3**, you can play up to 6 notes, each with 3 Unison voices.

In double Programs, the **Max # of Notes** applies equally to both OSC or EXi. For instance, if **Max # of Notes** is set to **4**, you can play up to 4 notes on each OSC/EXi.

Track 02...16 (Track Number)

Here you can make OSC settings for MIDI tracks 2 through 16. These are the same as for track 1. See “Track 01:”.

✓ 2-2: Page Menu Commands

- Compare →p.112
- Memory Status →p.521
- Exclusive Solo →p.113
- Rename Song →p.521
- Initialize Song →p.522
- Copy From Song →p.522
- Load Template Song →p.522
- Save Template Song →p.523
- FF/REW Speed →p.523
- Set Location (for Locate Key) →p.523
- GM Initialize →p.523
- Copy from Combi →p.525
- Copy From Program →p.525

- PAGE →p.126
- MODE →p.126

2-3: Pitch

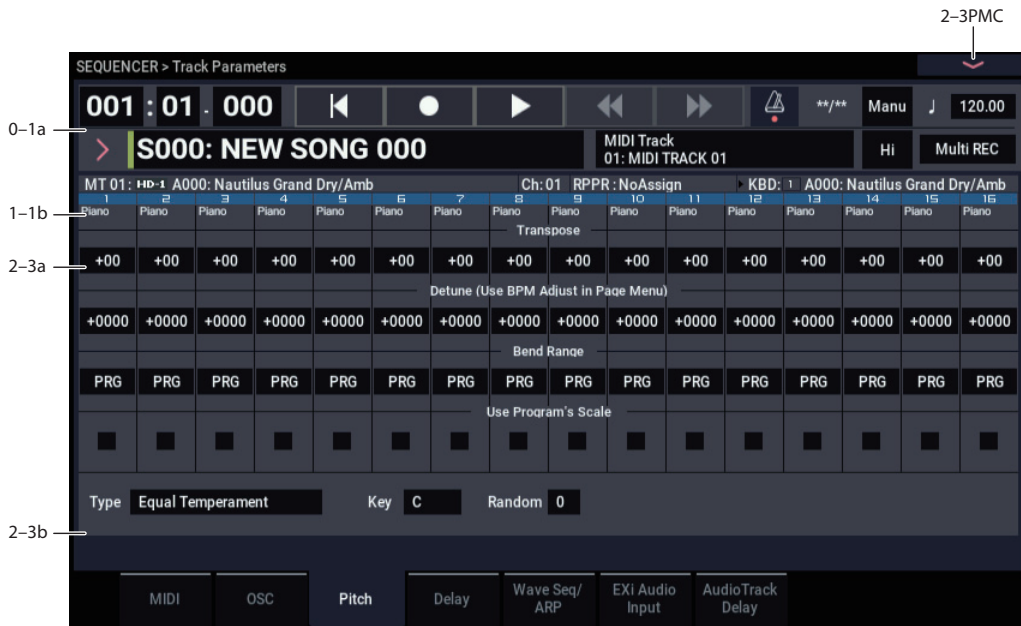

Here you can make pitch-related settings for each MIDI track.

2-3a: Pitch

Track 01 (Track Number)

Transpose [-60...+00...+60]

Adjusts the pitch of each MIDI track in semitone steps.
12 units equal one octave.

Detune (BPM Adj. in Page Menu) [-1200...+0000... +1200]

Adjusts the pitch of each MIDI track in one-cent units.
+0000: Normal pitch.

Note: You can also use the “Detune BPM Adjust” page menu command to automatically make a detune setting from a calculation in BPM units.

MIDI **Transpose** and **Detune** do not affect the notes transmitted via MIDI Out.

MIDI **Transpose** and **Detune** can be controlled via MIDI RPN messages received on the Track’s MIDI channel. The way that this works depends on whether or not the Track uses an HD-1 Drum Program.

If the Track does not use an HD-1 Drum Program—for example, if it uses a Single or Double HD-1 Program, or an EXi Program—then MIDI RPN Coarse Tune will control **Transpose**, and RPN Fine Tune will control **Detune**.

If the Track uses an HD-1 Drum Program, MIDI RPN Coarse Tune and Fine Tune will be combined to control **Detune**. The overall range is ±1 octave for coarse tune and fine tune together.

Bend Range [PRG, -24...+00...+24]

Specifies the amount of pitch change that will occur when the pitch bender is operated, in semitone units.

PRG: The pitch range specified by the program will be used.
-24...+24: This setting will be used regardless of the setting in the program.

MIDI As long as this set to something other than PRG, you can control the **Bend Range** using MIDI RPN Pitch Bend Change messages. For more information, please see “Bend Range” on page 408.

Use Program’s Scale [Off, On]

MIDI track can use the scale that is specified by Scale (PROGRAM 1-1f).

On (checked): The scale specified by the program will be used.

Off (unchecked): The scale specified by Scale (2-3b) will be used.

Track 2...16 (Track Number)

Here you can make pitch-related settings for MIDI tracks 2 through 16. The settings are the same as for track 1, as described above.

2-3b: Scale

Scale

Specifies the scale that the song will use. For more information, please see “1-1e: Scale” on page 38.

Type (Song’s Scale) [Equal Temperament...User Octave Scale15]

Selects the scale.

Key [C...B]

Selects the tonic key of the selected scale.

Random**[0...7]**

As this value is increased, an increasingly random deviation will be added to the pitch at each note-on.

MIDI If **Status** (2-1a) is INT, this setting will affect the pitch produced by the NAUTILUS. If **Status** is EXT, this setting will affect the note number of the note messages transmitted via MIDI.

✓ 2-3: Page Menu Commands

- Compare →p.112
- Memory Status →p.521
- Exclusive Solo →p.113
- Rename Song →p.521
- Initialize Song →p.522
- Copy From Song →p.522
- Load Template Song →p.522
- Save Template Song →p.523
- FF/REW Speed →p.523
- Set Location (for Locate Key) →p.523
- GM Initialize →p.523
- Copy from Combi →p.525
- Copy From Program →p.525
- Detune BPM Adjust →p.532

- PAGE →p.126
- MODE →p.126

2-4: Delay

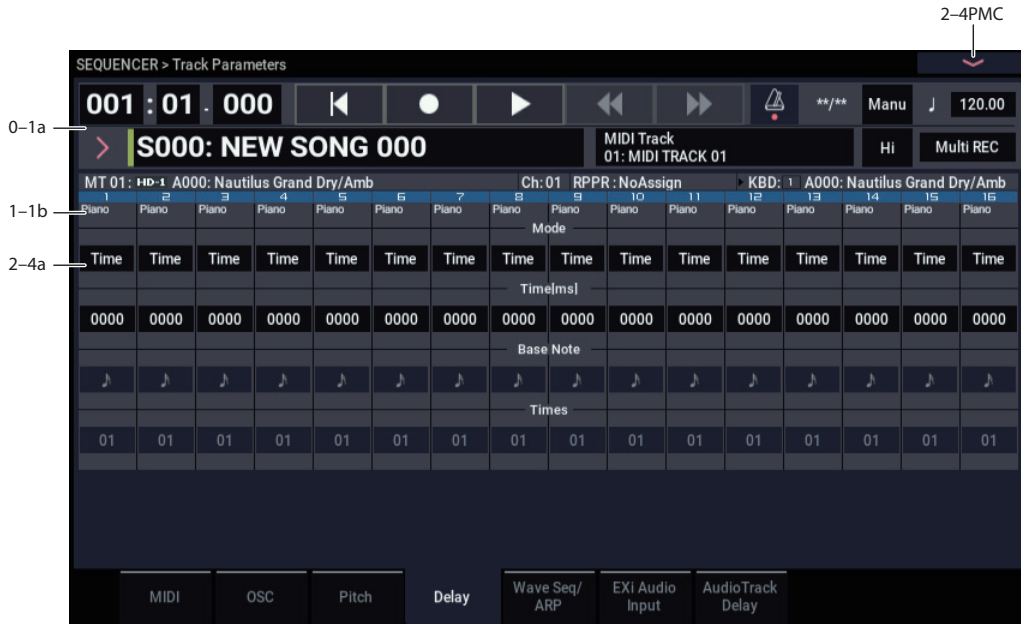

This specifies the time (delay) from when the MIDI track receives a note-on until the sound begins.

2-4a: Delay

Track 01 (Track Number)

Mode [Time, Tempo]

This selects whether the Track delay will be set in milliseconds, or in rhythmic units.

Time: Specify the delay time in units of milliseconds (ms = 1/1000th of a second).

Tempo: Specify the delay time in terms of a **Base Note** and **Times** relative to the system tempo. For example if **Base Note** = ♩, **Times** = 01, and **Tempo** = 60 BPM, the delay time will be equivalent to 1000 ms.

Time [ms] [0000...6000, KeyOff]

Specifies the time (delay time) from note-on until the MIDI track begins to produce sound, in units of ms (1/1000th of a second). This setting is available if “Mode” is set to Time.

KeyOff: The note will begin sounding at note-off. In this case, the sound will not die away if the sustain level of the program’s amp EG is other than 0. This setting is used when creating harpsichord sounds.

Normally you will set this to 0000.

Base Note [♪...♩]

Times [01...32]

This setting is available is “Mode” is set to Tempo. It specifies the time (delay time) from note-on until the MIDI track begins to produce sound, in terms of a note value relative to the “Tempo (♪)” (0-1a).

Use **Base Note** to specify the desired note value, and use **Times** to extend that note value by the specified multiple.

For example if you set **Base Note** to a quarter note (♪) and **Times** to 02, that MIDI track will sound with a delay of a half note (♩). Even if you change “Tempo (♪)” (0-1a), the delay time will always be a half note (♩). If you use these parameters to specify a delay of a half note (♩). In this case, a **Tempo** of 60.00 BPM will produce a 2000 ms delay, and a **Tempo** of 120.00 BPM will produce a 1000 ms delay.

Track 02... 16 (Track Number)

These are the delay time settings for MIDI tracks 2 through 16. They are the same as for track 1. See “Track 01”.

✓ 2-4: Page Menu Commands

- Compare →p.112
- Memory Status →p.521
- Exclusive Solo →p.113
- Rename Song →p.521
- Initialize Song →p.522
- Copy From Song →p.522
- Load Template Song →p.522
- Save Template Song →p.523
- FF/REW Speed →p.523
- Set Location (for Locate Key) →p.523
- GM Initialize →p.523
- Copy from Combi →p.525
- Copy From Program →p.525
- PAGE →p.126
- MODE →p.126

2-5: Wave Seq/ARP

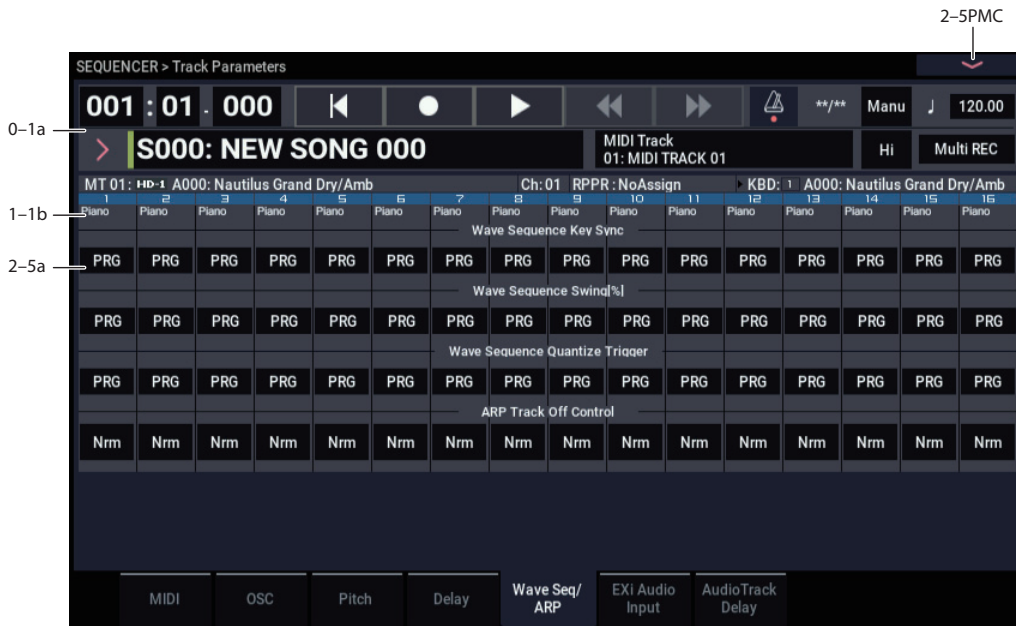

Here you can make settings related to wave sequence and Arpeggiator functionality for each MIDI track.

2-5a: Wave Sequence/ARP

Track 01 (Track Number)

Wave Sequence Key Sync [PRG, Off, On]

Specifies the wave sequence **Key Sync** setting (PROGRAM 1-1e) of the program selected for the MIDI track. This setting is valid if the program uses a wave sequence.

PRG: The setting of the program is used.

Off: **Key Sync** is forced off. The wave sequence of each note will synchronize to the same step.

On: **Key Sync** is forced on. The wave sequence will start each time you press a key. If the wave sequences have differing steps or rates, they will proceed independently.

For more information, please see “Key Sync” on page 39.

Wave Sequence Swing% [PRG, -300....+300]

Specifies the wave sequence “Swing” setting (PROGRAM 1-1e) of the program selected for the MIDI track. This setting is valid if the program uses a wave sequence.

PRG: The setting of the program is used.

-300...+300: The Swing% specified here is used regardless of the program’s “Swing%” setting.

For more information, please see “Swing” on page 39.

Wave Sequence Quantize Trigger [PRG, Off, On]

This allows you to override the Program’s Wave Sequence “Quantize Trigger” setting (PROGRAM 1-1e). If you’re using multiple Programs with rhythmic Wave Sequences, you can use this to synchronize all of the Wave Sequences at note-on.

Note that Quantize Trigger applies only when the Wave Sequence’s **Mode** is set to Tempo. For more information, see “Mode” on page 657.

PRG: The setting of the program is used.

Off: “Quantize Trigger” is forced off. The wave sequence will trigger immediately after note-on.

On: “Quantize Trigger” is forced on. The wave sequence pattern will synchronize to eighth-note timing of the currently-sounding wave sequence; i.e., the trigger will be quantized.

For more information, please see “Quantize Trigger” on page 39.

ARP Track Off Control [Normal, Track Off by ARP Off, Track Off by ARP On]

Nrm (Normal): The ARP ON/OFF button will not control whether the track will sound. Usually you will use the Normal setting.

by Off (Track Off by ARP Off): The track will sound as usual when the ARP ON/OFF button is on. The track will not sound when the ARP ON/OFF button is off.

Use this when you want a specific track of multiple tracks set to the same MIDI channel to be silent only when Arpeggiator is off.

by On (OSC Off by ARP On): The track will not sound when the ARP ON/OFF button is on. The track will sound as usual when the ARP ON/OFF button is off.

Use this when you are using an arpeggiator to control multiple tracks that are set to the same MIDI channel, and want a specific track to be silent only when Arpeggiator is on.

For example you can use this to play a two-track layer from the keyboard when Arpeggiator is off, and use one track to sound the phrase when Arpeggiator is on.

If the **Status** (0–1b) of each track is INT, you can use the “Track On/Off Ctrl” setting to stop the oscillator of each track from sounding.

- 🔊 If you set “OSC On/Off Ctrl” to by Off or by On settings and operate the ARP ON/OFF button while real-time-recording a song, you must be aware of the following points.
 - In order to control this parameter during playback, operations of the ARP ON/OFF button must be recorded in real-time.
 - Set “ARP ON/OFF” (GLOBAL 5–1b) to MIDI CC#14. If this is assigned to MIDI CC#14, operations of the ARP ON/OFF button can be recorded in real-time. (See “5–1b: MIDI CC# Assign - Controllers” on page 675)
 - Operations will also be recorded if you assign this key to MIDI CC#00–95, but in order to avoid confusion when receiving another CC#, you should use CC#14.
 - “ARP ON/OFF” (GLOBAL 5–1b) will also be set to MIDI CC#14 if you execute the page menu command “Reset Controller MIDI Assign” with “To:” set to Default Setting. After executing, turn the assignment Off for other MIDI CC# Assign –ARP Controllers that you do not need to record.

Track 02... 16 (Track Number)

These are the wave sequence and Arpeggiator-related settings for MIDI tracks 2 through 16. They are the same as for track 1. See “Track 01”:

✓ 2–5: Page Menu Commands

- Compare →p.112

- Memory Status →p.521
- Exclusive Solo →p.113
- Rename Song →p.521
- Initialize Song →p.522
- Copy From Song →p.522
- Load Template Song →p.522
- Save Template Song →p.523
- FF/REW Speed →p.523
- Set Location (for Locate Key) →p.523
- GM Initialize →p.523
- Copy from Combi →p.525
- Copy From Program →p.525

- PAGE →p.126
- MODE →p.126

2-6: EXi Audio Input

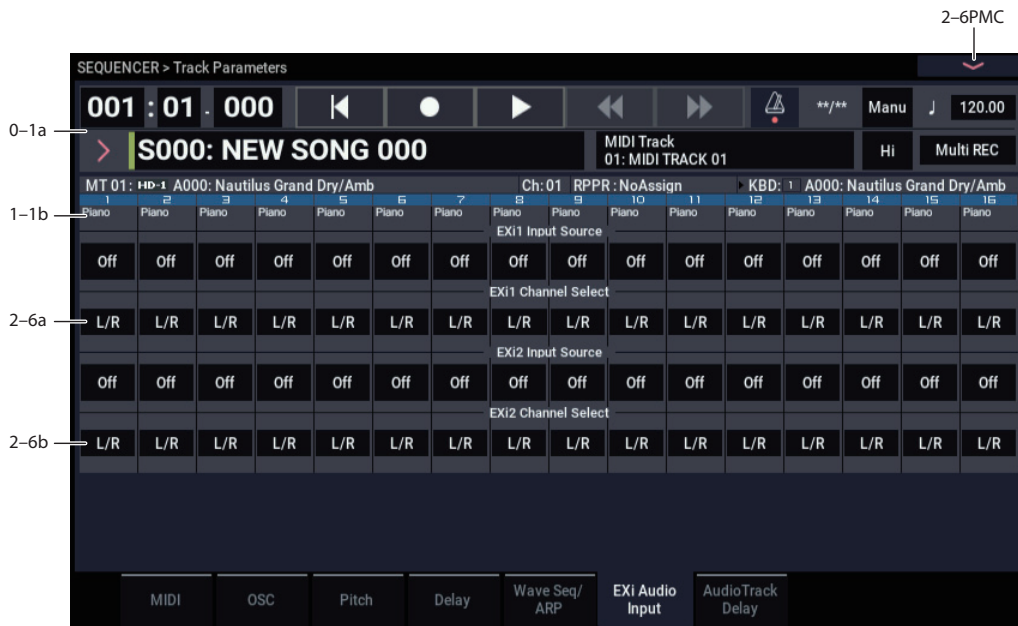

These parameters let you route audio into EXi instruments which support audio input, including the STR-1, MS-20EX, and MOD-7. You can use this to create feedback loops, or to process live or recorded audio through the EXi's synthesis engine.

EXi which do not support audio input will ignore these settings. The AL-1 supports audio input, but uses its own dedicated routing which is not affected by these parameters.

For more information on using audio inputs with EXi, see:

AL-1: "4-3c: Sub OSC/Audio Input" on page 149

STR-1: "4-8c: Feedback" on page 231

MS-20EX: "6-1k: EXTERNAL SIGNAL PROCESSOR (ESP)" on page 273

MOD-7: "5-1f: EXi Audio Input" on page 319

2-6a: EXi 1

Input Source [PRG, Off, Audio Input 1/2, USB 1/2, L/R Output, Indiv. Output 1/2...3/4, REC 1/2...3/4, FX Control 1, 2, IFX 1...12, MFX 1, 2, TFX 1, 2]

This selects the input source for EXi1. You can use this to create a feedback loop, if desired.

PRG uses the setting stored in the Program. You may find this convenient if you use Program Change messages to switch between two EXi Programs, and wish to have the input enabled for one, but disabled for the other. For more information, see "4-2: EXi Audio Input" on page 134.

Off disables the input.

Audio Input 1/2, and **USB 1/2**, use the live audio from the selected input.

L/R Output and **Indiv. Output 1/2...3/4** use the audio as it is heard from the selected output (like connecting a cable from the output back to the input).

REC 1/2...3/4 and **FX Control 1, 2** use the audio from the selected bus.

IFX 1...12, **MFX 1, 2**, and **TFX 1, 2** use the output of the selected effect.

Channel Select [Stereo/L+R, Left, Right]

Stereo/L+R: This selection routes a stereo signal to EXi with stereo inputs, and an L+R summation to EXi with mono inputs.

Left, Right: This uses only a mono signal from the selected channel.

2-6b: EXi 2

EXi 2 has the same controls as EXi 1, above.

2-6: Page Menu Commands

- Compare →p.112
- Memory Status →p.521
- Exclusive Solo →p.113
- Rename Song →p.521
- Initialize Song →p.522
- Copy From Song →p.522
- Load Template Song →p.522
- Save Template Song →p.523
- FF/REW Speed →p.523
- Set Location (for Locate Key) →p.523
- GM Initialize →p.523
- Copy from Combi →p.525
- Copy From Program →p.525
- PAGE →p.126
- MODE →p.126

2-7: Audio Track Delay

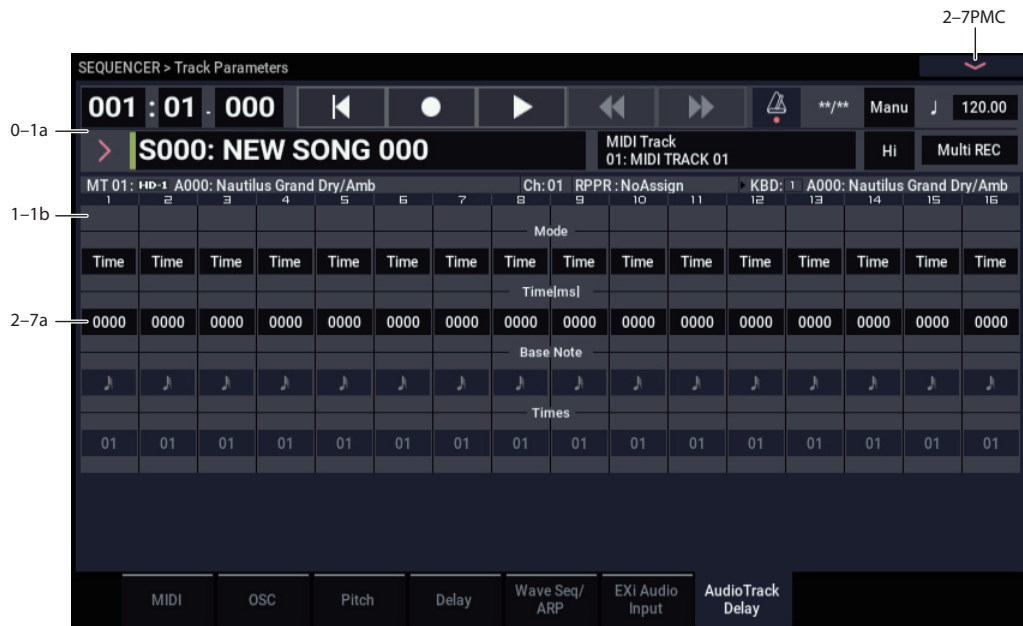

Here you can specify a delay time by which the audio events of each audio track will be delayed relative to their “Location.”

2-7a: Delay

Track 01...16 (Track Number)

STEREO

This is shown if **Stereo Pair** is on.

Mode [Time, Tempo]

Time [ms] [0000...6000]

Base Note [♪, ♪, ♪, ♪, ♪, ♪, ♪, ♪, ♪, ♪, ♪, ♪, ♪, ♪, ♪, ♪]

Times [01...32]

For more information, please see “2-4a: Delay” on page 484.

✓ 2-7: Page Menu Commands

- Compare →p.112
- Memory Status →p.521
- Exclusive Solo →p.113
- Rename Song →p.521
- Initialize Song →p.522
- Copy From Song →p.522
- Load Template Song →p.522
- Save Template Song →p.523
- FF/REW Speed →p.523
- Set Location (for Locate Key) →p.523
- GM Initialize →p.523
- Copy from Combi →p.525
- Copy From Program →p.525
- PAGE →p.126
- MODE →p.126

SEQUENCER > MIDI Filter/Zones

3-1: MIDI Filter1



Here you can select whether or not to apply filtering to the MIDI data received by MIDI tracks 1–16. For example even if two tracks are receiving the same MIDI channel, one can be set to respond to damper pedal activity while the other does not.

MIDI These MIDI filter settings have no effect on the MIDI messages that have already been recorded.

MIDI These settings affect the MIDI messages that are transmitted when you adjust program, pan, volume, portamento and send 1/2 parameters of a track whose **Status** (2–1a) is set to Both, EXT, or EX2.

On (checked): Reception of MIDI data is enabled. Tracks whose **Status** (2–1a) is INT or Both will receive these types of MIDI messages on their respective channels. The type of effects that are checked will be applied to the program of each track when the NAUTILUS’s controllers are operated or when MIDI data is received. (The effect dynamic modulation function is not affected by these settings.)

Settings that regulate MIDI transmission/reception of the NAUTILUS itself are made in MIDI Filter (GLOBAL 1–1c).

If the user-assignable controllers that can be filtered in the MIDI Filter 2 and 3 pages are set to MIDI control changes, filtering will be performed for these control changes. In this case, any control change filtering that is being performed in the MIDI Filter 1 and 2 pages will be given priority. Furthermore, if the same control change is assigned to multiple controllers for which there are filter settings in the MIDI Filter 2 and 3 pages, checking any one of these will enable that control change.

Off (unchecked): Reception of MIDI data is disabled.

Note: MIDI CC# = MIDI control change message numbers.

3-1a: MIDI Filter 1

Track 01 (Track Number)

Enable Program Change [Off, On]

Specifies whether or not MIDI program change messages will be received.

Enable After Touch [Off, On]

Specifies whether or not MIDI after touch messages will be received.

Enable Damper [Off, On]

Specifies whether or not MIDI CC#64 hold (damper pedal) messages will be received.

Enable Portamento SW [Off, On]

Specifies whether or not MIDI CC#65 portamento on/off messages will be received.

Enable JS X as AMS [Off, On]

Specifies whether or not MIDI pitch bend messages (the X axis of the NAUTILUS’s joystick) will be received to control the AMS effect assigned to JS X. (This is not a filter for MIDI pitch bend message reception.) For more information, please see “Alternate Modulation Sources (AMS)” on page 901.

Enable JS+Y [Off, On]

Specifies whether or not MIDI CC#01 (the +Y axis of the NAUTILUS’s joystick) will be received.

Enable JS–Y [Off, On]

Specifies whether or not MIDI CC#02 (the –Y axis of the NAUTILUS’s joystick) will be received.

Track 02...16 (Track Number)

These are the MIDI Filter 1 settings for MIDI tracks 2 through 16. They are the same as for track 1. See “Track 01:”.

▼ 3-1: Page Menu Commands

- Compare →p.112
- Memory Status →p.521
- Exclusive Solo →p.113
- Rename Song →p.521
- Initialize Song →p.522
- Copy From Song →p.522
- Load Template Song →p.522
- Save Template Song →p.523
- FF/REW Speed →p.523
- Set Location (for Locate Key) →p.523
- GM Initialize →p.523
- Copy from Combi →p.525
- Copy From Program →p.525

- PAGE →p.126
- MODE →p.126

3-2: MIDI Filter2



Here you can enable transmission for the RT Control Knobs 1-6.

3-2a: MIDI Filter 2

Track 01 (Track Number)

Enable Realtime Control Knob 1 [Off, On]

Sets whether to receive MIDI CC#74 (the filter cutoff frequency of the NAUTILUS) from RT control knob 1 when you use the SELECT button to select "SOUND".

Enable Realtime Control Knob 2 [Off, On]

Sets whether to receive MIDI CC#71 (the filter resonance level of the NAUTILUS) from RT control knob 2 when you select "SOUND" with the SELECT button.

Enable Realtime Control Knob 3 [Off, On]

Sets whether to receive MIDI CC#79 (the filter EG intensity of the NAUTILUS) from RT control knob 3 when you select "SOUND" with the SELECT button.

Enable Realtime Control Knob 4 [Off, On]

Sets whether to receive MIDI CC#72 (the filter/amp EG release times of the NAUTILUS) from RT control knob 4 when you select "SOUND" with the SELECT button.

Enable Realtime Control Knob 5 [Off, On]

Sets whether to receive MIDI CC#20 (EFFECT) from RT control knob 5 when you select "SOUND" with the SELECT button.

Enable Realtime Control Knob 6 [Off, On]

Sets whether to receive MIDI CC#21 (REVERB) from RT control knob 6 when you select "SOUND" with the SELECT button.

Track 02... 16 (Track Number)

These are the MIDI Filter 2 settings for MIDI tracks 2 through 16. They are the same as for track 1. See "Track 01:".

3-2: Page Menu Commands

- Compare →p.112
- Memory Status →p.521
- Exclusive Solo →p.113
- Rename Song →p.521
- Initialize Song →p.522
- Copy From Song →p.522
- Load Template Song →p.522
- Save Template Song →p.523
- FF/REW Speed →p.523
- Set Location (for Locate Key) →p.523
- GM Initialize →p.523
- Copy from Combi →p.525
- Copy From Program →p.525
- PAGE →p.126
- MODE →p.126

3-3: MIDI Filter3



3-3a: MIDI Filter 3

Track 01 (Track Number)

Enable SW1 [Off, On]

Enable SW2 [Off, On]

Specifies whether or not the effect of the SW1 and SW2 buttons will be received.

The function of these buttons is specified in the EQ/X-Y/Controllers- Controllers page.

These settings are valid if these keys are assigned to SW1 Mod. (CC#80), SW2 Mod. (CC#81), or Portamento SW (CC#65).

Enable Foot Switch [Off, On]

Specifies whether or not the effect of the ASSIGNABLE SWITCH will be received. The function is assigned in GLOBAL > Controllers/Scales- Controllers page. This filter setting is valid when a MIDI control change is assigned.

Enable Foot Pedal [Off, On]

Specifies whether or not the effect of the ASSIGNABLE PEDAL will be received. The function is assigned in GLOBAL > Controllers/Scales- Controllers page. This filter setting is valid when a MIDI control change is assigned.

Enable Other Control Change Messages [Off, On]

Specifies whether or not MIDI control messages not covered in the preceding items MIDI Filter will be received.

Track 02... 16 (Track Number)

These are the MIDI Filter 3 settings for MIDI tracks 2 through 16. They are the same as for track 1, as described above.

3-3: Page Menu Commands

- Compare →p.112
- Memory Status →p.521
- Exclusive Solo →p.113
- Rename Song →p.521
- Initialize Song →p.522
- Copy From Song →p.522
- Load Template Song →p.522
- Save Template Song →p.523
- FF/REW Speed →p.523
- Set Location (for Locate Key) →p.523
- GM Initialize →p.523
- Copy from Combi →p.525
- Copy From Program →p.525
- PAGE →p.126
- MODE →p.126

3-5: Keyboard Zones



Here you can specify the key zones in which MIDI tracks 1–16 will sound.

The top/bottom key settings specify the zone in which MIDI tracks 1–16 will sound, and the top/bottom slope settings specify the key range over which the volume will change starting from the top/bottom key.

MIDI These settings do not affect MIDI transmission/reception. All note data that is received will be recorded into the internal sequencer, and all note data from the internal sequencer or from the keyboard will be transmitted.

3-5a: Zone Map

This area provides a graphic display of the note and velocity ranges in which each MIDI Track will sound. The slope portions of the zones are displayed in a different color.

Under the Key Zone graphic, a keyboard graphic shows the most recently-played note in green, aligned with the keyboard zones.

To the left of the Velocity Zone graphic, a meter shows the velocity of the most recently-played note; red dots above the graphic show the Zone(s) triggered by that velocity.

Zone Map

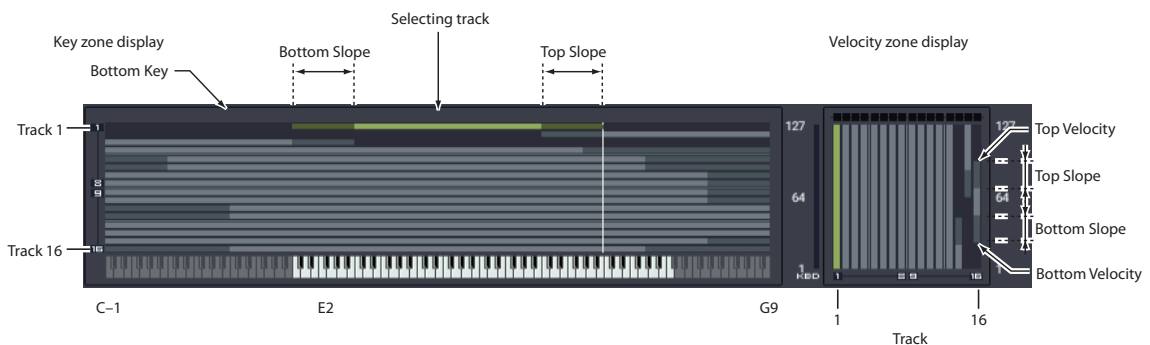

3-5b: Keyboard Zones

Track 01 (Track Number)

Top Key [C-1...G9]

Specifies the top key (upper limit) of the notes that will sound each MIDI track.

Top Slope [00, 01, 02, 03, 04, 06, 08, 10, 12, 18, 24, 30, 36, 48, 60, 72]

Specifies the range of keys (12 is one octave) over which the volume will be reached starting from the top key.

0: The volume will be at the original level from the top key.

12: The volume will increase gradually as you play downward, and will reach the original volume one octave below the top key.

72: The volume will increase gradually as you play downward, and will reach the original volume six octaves below the top key.

Bottom Slope [00, 01, 02, 03, 04, 06, 08, 10, 12, 18, 24, 30, 36, 48, 60, 72]

Specifies the range of keys (12 is one octave) over which the volume will be reached starting from the bottom key.

0: The volume will be at the original level from the bottom key.

12: The volume will increase gradually as you play upward, and will reach the original volume one octave above the bottom key.

72: The volume will increase gradually as you play upward, and will reach the original volume six octaves above the bottom key.

Bottom Key [C-1...G9]

Specifies the bottom key (lower limit) of the notes that will sound each MIDI track.

How volume will change according to keyboard location

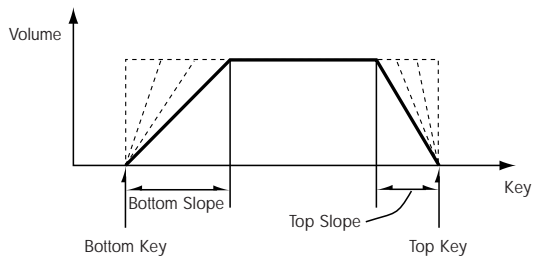

Top Key and **Bottom Key** settings can also be input by holding down the ENTER button and playing a note on the keyboard.

- ⚠ It is not possible to set the bottom key above the top key of the same track. Nor is it possible for the top and bottom slopes to overlap.

Track 02... 16 (Track Number)

These are the key zone settings for MIDI tracks 2 through 16. They are the same as for track 1. See "Track 01":.

✓ 3-5: Page Menu Commands

- Compare →p.112
- Memory Status →p.521
- Exclusive Solo →p.113
- Rename Song →p.521
- Initialize Song →p.522
- Copy From Song →p.522
- Load Template Song →p.522
- Save Template Song →p.523
- FF/REW Speed →p.523
- Set Location (for Locate Key) →p.523
- GM Initialize →p.523
- Copy from Combi →p.525
- Copy From Program →p.525

- PAGE →p.126
- MODE →p.126

3-6: Velocity Zones



Here you can set the Top/Bottom Velocity parameters to specify the range of velocities that will be sounded by MIDI tracks 1-16, and Top/Bottom Slope specify the range over which the volume will be adjusted.

MIDI These settings do not affect MIDI transmission/reception. All note data that is received will be recorded into the internal sequencer, and all note data from the internal sequencer or from the keyboard will be transmitted.

! It is not possible to set the bottom velocity greater than the top velocity for the same track. Nor can the top slope and the bottom slope overlap.

3-6a: Zone Map

This area provides a graphic display of the note and velocity ranges in which each MIDI Track will sound. The slope portions of the zones are displayed in a different color.

Under the Key Zone graphic, a keyboard graphic shows the most recently-played note in green, aligned with the keyboard zones.

To the left of the Velocity Zone graphic, a meter shows the velocity of the most recently-played note; red dots above the graphic show the Zone(s) triggered by that velocity.

For more information, please see “3-5a: Zone Map” on page 493.

3-6b: Velocity Zones

Track 01 (Track Number)

Top Velocity [1...127]

Specifies the maximum velocity value that will sound each track.

Top Slope [0...120]

Specifies the number of velocity steps over which the original volume will be reached, starting from the Top Velocity.

0: The volume will be at the original value from the top velocity.

120: The volume will decrease as the velocity approaches the top velocity.

Bottom Slope [0...120]

Specifies the number of velocity steps over which the original volume will be reached, starting from the Bottom Velocity.

0: The volume will be at the original value from the bottom velocity.

120: The volume will decrease as the velocity approaches the bottom velocity.

Bottom Velocity [1...127]

Specifies the minimum velocity that will be sounded by each MIDI track 1-16.

How volume will change according to keyboard location

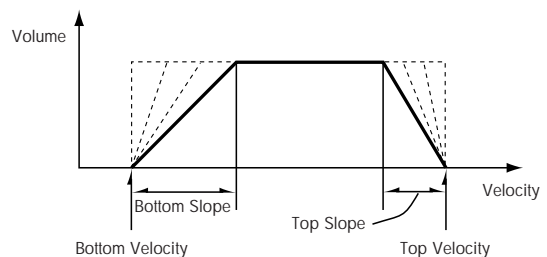

“Top Velocity” and “Bottom Velocity” settings can also be input by holding down the ENTER button and playing a note on the keyboard.

Track 02...16 (Track Number)

These are the velocity zone settings for MIDI tracks 2 through 16. They are the same as for track 1. See “Track 01”:

▼ 3-6: Page Menu Commands

- Compare →p.112
- Memory Status →p.521
- Exclusive Solo →p.113
- Rename Song →p.521
- Initialize Song →p.522
- Copy From Song →p.522
- Load Template Song →p.522
- Save Template Song →p.523
- FF/REW Speed →p.523
- Set Location (for Locate Key) →p.523
- GM Initialize →p.523
- Copy from Combi →p.525
- Copy From Program →p.525
- PAGE →p.126
- MODE →p.126

SEQUENCER > Track Edit

4-1: Track Edit

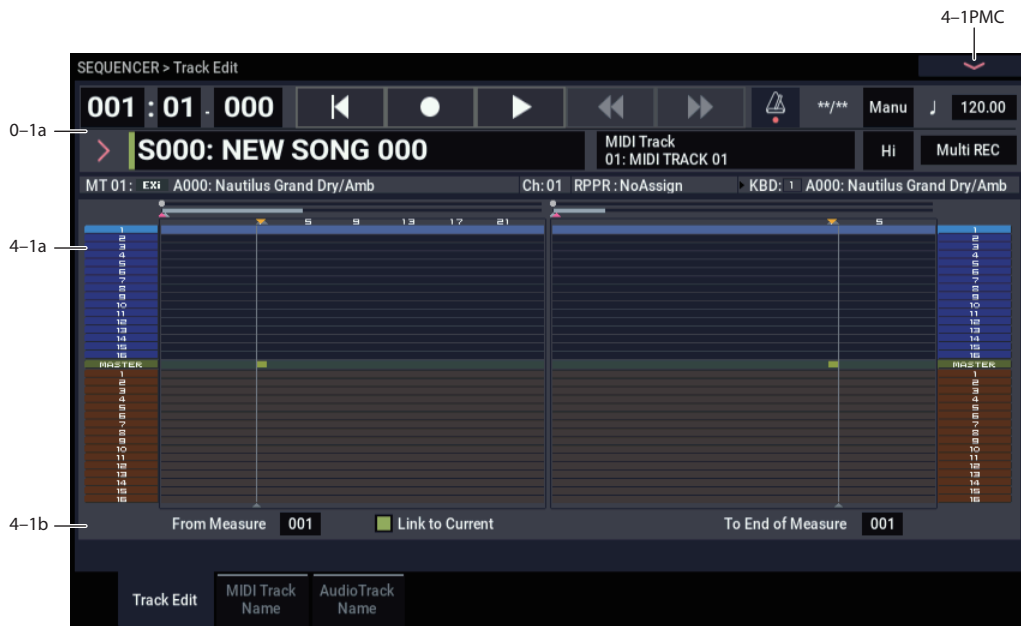

Here you can edit MIDI tracks, the master track, and audio tracks.

When editing a MIDI track, you can move, insert, and delete individual events of note or control change data, or copy, move, insert, and delete measures or tracks. You can also perform Step Recording in this page.

When editing the master track, you can edit the tempo and time signature data.

You can edit audio tracks by moving/inserting/ deleting individual data events, or by copying/moving/inserting/deleting specified measures or tracks.

Note: To perform track editing (or step editing), use **Track Select** to select the track you want to edit, and use **From Measure** and **To End of Measure** parameters to specify the

region that you want to edit. Then choose a command from the page menu, and execute the edit. For details on the specific commands, see “SEQUENCER: Page Menu Commands” on page 521.

4-1a: Track data Map

This area shows the presence or absence of performance data, and indicates the edit range, etc. The currently selected Track will be highlighted.

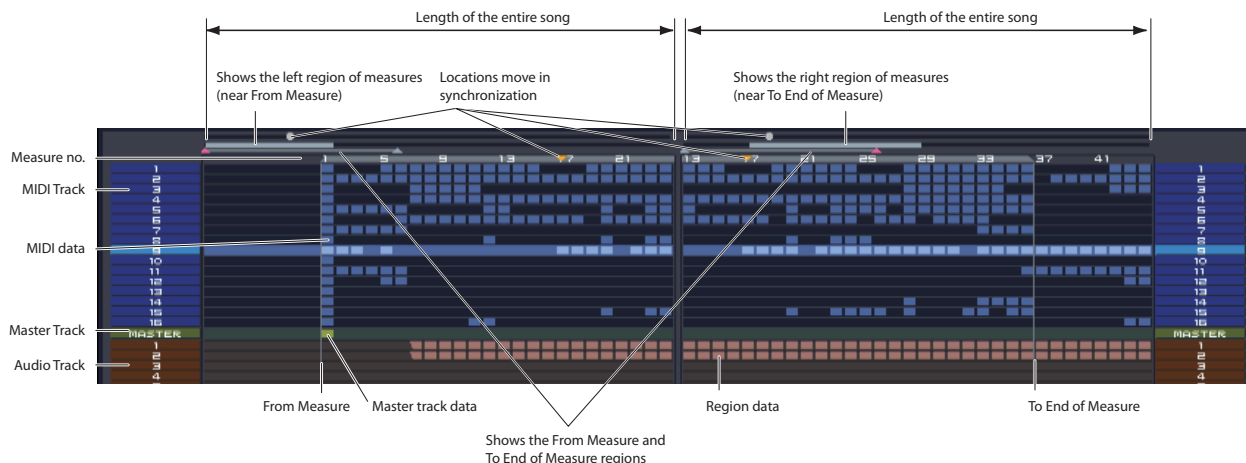

4-1b: Track Select, From Measure, To End of Measure

Track Select[MIDI Track01...MIDI Track16, Master Track, Audio Track01...Audio Track16]

Here you can select the track you want to edit (or use as the copy-source) or record.

If you want to perform an operation on all tracks, you don't need to specify a track here. Simply turn on **All Tracks** in the page menu command dialog box.

MIDI Track 01...16: Choose this if you want to edit a MIDI track.

Master Track: Choose this if you want to edit the master track.

Audio Track 01...16: Choose this if you want to edit an audio track.

If you select an audio track for which stereo pairing is enabled, and execute an edit, the same edit will also be applied to the other audio track of the pair. However, automation edits will affect only one audio track.

Note: The available page menu commands will differ depending on whether you select a MIDI Track 01–MIDI Track 16 or Master Track, or an Audio Track 01–Audio Track 16.

From Measure [001...999]

To End of Measure [001...999]

Specifies the range of measures that you wish to edit (or copy from) or step-record.

Use **From Measure** to specify the starting measure, and **To End of Measure** to specify the ending measure.

Link To Current [Off, On]

When this check-box is enabled, the **From Measure** setting will continuously update to match the current location, including during playback and recording. The display will also scroll to follow the current location.

✓ 4-1: Page Menu Commands

MIDI Track Edit commands

- Compare →p.112
- Memory Status →p.521
- Exclusive Solo →p.113
- MIDI Step Recording →p.532
- MIDI Event Edit →p.533
- Set Song Length →p.538
- Erase Track →p.539
- Copy Track →p.539
- Bounce Track →p.539
- Erase Measure →p.540
- Delete Measure →p.541
- Insert Measure →p.541
- Repeat Measure →p.542
- Copy Measure →p.543
- Move Measure →p.544

- Create Control Data →p.544
- Erase Control Data →p.545
- Quantize →p.545
- Shift/Erase Note →p.546
- Modify Velocity →p.547
- FF/REW Speed →p.523
- Set Location (for Locate Key) →p.523

- PAGE →p.126
- MODE →p.126

Audio Track Edit commands

- Compare →p.112
- Memory Status →p.521
- Exclusive Solo →p.113
- Audio Event Edit →p.535
- Audio Automation Edit →p.538
- Set Song Length →p.538
- Erase Track →p.539
- Copy Track →p.539
- -----
- Erase Measure →p.540
- Delete Measure →p.541
- Insert Measure →p.541
- Repeat Measure →p.542
- Copy Measure →p.543
- Move Measure →p.544
- Region Edit →p.547
- Volume Ramp →p.549
- Copy Song's Tempo to Region →p.550
- Adjust Song's Tempo to Region →p.550
- Adjust Region to Song's Tempo →p.550
- FF/REW Speed →p.523
- Set Location (for Locate Key) →p.523

- PAGE →p.126
- MODE →p.126

4-2: MIDI Track Name

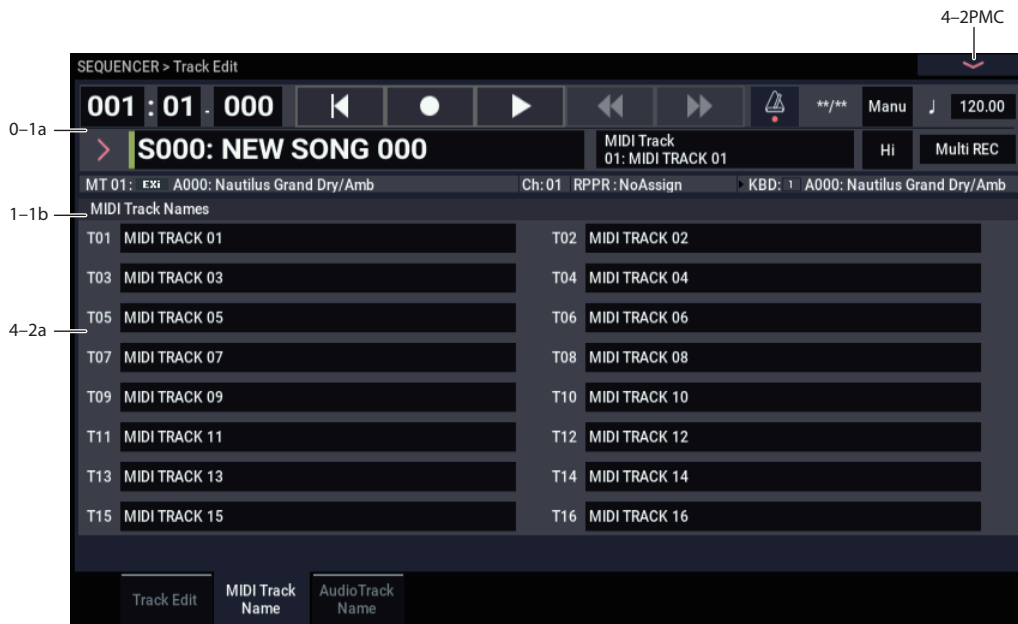

Here you can assign a name to each track.

4-2a: MIDI Track Names

T01...T16 [MIDI Track Name]

Here you can rename the MIDI tracks.

Press the text edit button to open the dialog box, and set the name as desired (up to 24 characters). If a USB QWERTY keyboard (commercially available) is connected, you can use this to enter text instead of the on-screen keyboard. For more information, see “Editing names and entering text” on page 206 of the OG.

✓ 4-2: Page Menu Commands

The available commands will be different depending on whether the currently selected Track is MIDI or Audio.

The commands are exactly the same as for the main Track Edit page; for more information, see “MIDI Track Edit commands” on page 498, and “Audio Track Edit commands” on page 498.

4-3: Audio Track Name

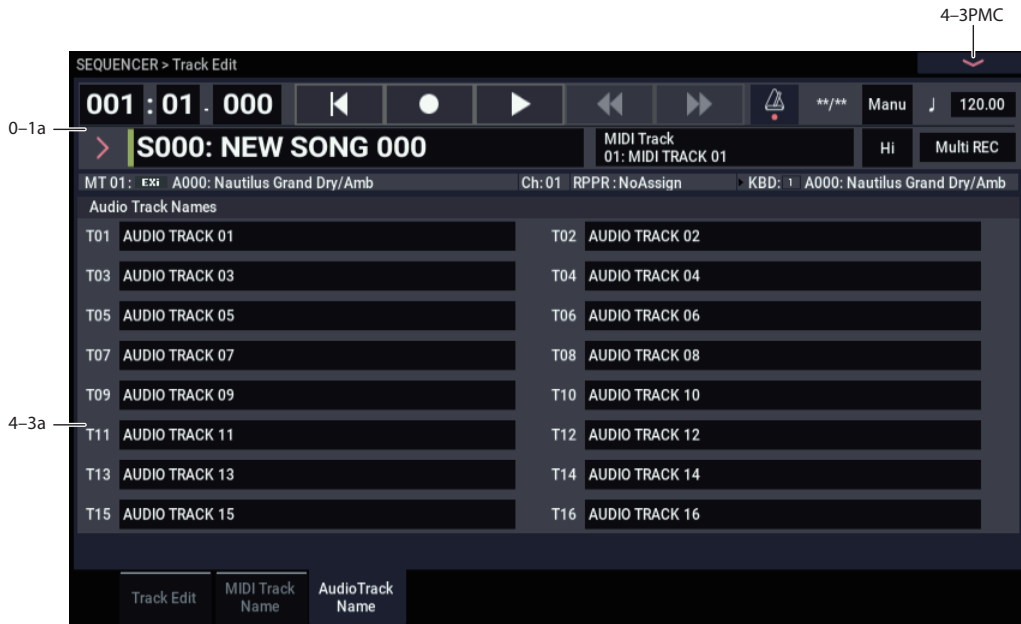

Here you can assign a name to each audio track.

4-3a: Audio Track Names

T01...T16 **[Audio Track Name]**

Here you can rename the audio tracks.

Press the text edit button to open the dialog box, and set the name as desired (up to 24 characters). If a USB QWERTY keyboard (commercially available) is connected, you can use this to enter text instead of the on-screen keyboard. For more information, see “Editing names and entering text” on page 206 of the OG.

4-3: Page Menu Commands

The available commands will be different depending on whether the currently selected Track is MIDI or Audio.

SEQUENCER > Pattern/RPPR

On the NAUTILUS you can use preset patterns, and user patterns.

Preset patterns provide patterns that are suitable for drum tracks, and can be selected from any song.

One hundred (U00-99) user patterns are provided for each song; you can create and store your own patterns in these.

Normally, you will create a track of performance data by using the “Put To MIDI Track” or “Copy To MIDI Track” page menu commands to place patterns consisting of several measures into a track. You can also use the RPPR function,

which lets you trigger patterns assigned to each key simply by pressing the desired key, and realtime-record the patterns that play back. (See the RPPR Setup page.)

The user patterns that you make can be converted into user drum track patterns. This can be used by the drum track function in PROGRAM, COMBINATION and SEQUENCER mode.

For more information, see “Convert to Drum Track Pattern” on page 553.

5-1: Pattern Edit



Here you can record and edit patterns, and assign them to tracks of a song. The following types of pattern operations are available.

User patterns can be recorded in real-time, step-recorded, or created using the Get From MIDI Track command or Copy Pattern command. You can also copy a preset pattern to a user pattern and edit it. (You can't directly edit a preset pattern.)

Preset patterns and user patterns can be placed in or copied into a track.

User patterns can also be converted into Drum Track Patterns, which can then be used in the Drum Track in Programs and Combinations, as well as Songs. For more information, see “Convert to Drum Track Pattern” on page 553.

5-1a: Location, Song/Track Select, Metronome, Resolution, Tempo

Location [01...99]

Displays the current measure location of the selected pattern.

Length/Meter

Displays the pattern length and meter. When “User Pattern” is selected, the User Pattern settings can be changed (→PMC > Pattern Parameter).

Song Name [000...199: name]

Selects a song.

The user pattern will be created in the song you select.







Track Select [MIDI Track01...MIDI Track16, Master Track, Audio Track01...Audio Track16]

Selects the track that will be used to record/play the pattern data. The pattern data will be recorded/played using the settings of the track you select. The area at the right displays the program bank, number, and name for the selected track.

⚠ Settings of Master Track, Audio Track 01-16 will be ignored. The most recently selected MIDI Track 01-16 will be used.

Metronome [Only REC, REC & Play, Off]

Specifies whether the metronome will sound during recording or playback. For details, see “0-6d: Metronome Setup” on page 459.

Rec Resolution [Hi, , , , , , , , ]

Specifies how the timing of the data being recorded into the pattern will be corrected. For details, see “REC Resolution (Realtime REC Quantize Resolution)” on page 446.

Remove Data [Off, On]

On (checked): Unwanted performance data can be removed during pattern recording. The procedure is the same as explained in “Remove Data” of Loop All Tracks. For details, see “Remove Data” on page 457.

♩ (Tempo) [040.00...300.00, EXT]

Specifies the playback tempo of the pattern. For details, see “♩ (Tempo)” on page 444.

5–1b: Pattern, Pattern Select**How to record a user pattern**

1. Use “Song Select” to select the song in which you want to create a user pattern.
2. Use Track Select to select the sound that you will record.
The pattern you record will sound according to your choice in Track Select.
3. Use Pattern Bank and Pattern Select to select User pattern and the desired pattern number.
4. Select the page menu command “Pattern Parameter,” and in the dialog box, specify the number of measures and time signature of the pattern.
5. Check the tempo in “♩”.
6. If you want to record in realtime, set “Resolution” to specify the resolution, and press the SEQUENCER REC button and then the START/STOP button to begin recording.

When you finish recording to the end of the measures specified by “Pattern Parameter,” you will return to the first measure, and can continue recording while adding more material. For details, see “Loop All Tracks” on page 457.

If you want to perform step recording, select the page menu command “Step Recording (Loop Type)” to open the dialog box, and record. For the procedure of step recording, see “MIDI Step Recording” on page 532 and “Step Recording (Loop Type)” on page 551.

7. After recording, use the page menu commands as desired to edit the pattern or the events in the pattern.

Pattern (Pattern Bank) [Preset, User]

Selects the type of pattern.

If Preset is selected, it will not be possible to record. You will be able to select and execute the “Copy Pattern,” “Bounce Pattern,” “Put To MIDI Track,” and “Copy To MIDI Track” page menu commands.

Pattern Select [P000..., U00...U99]

Selects a pattern.

Refer to the “Voice Name List” for a list of preset patterns.

User patterns can be renamed in the Pattern/RPPR– Pattern Name page.

5–1c: USED IN SONG TRACK, USED IN RPPR**USED IN SONG TRACK**

This area indicates the pattern usage status for the patterns selected for the track.

USED IN RPPR

This area indicates the RPPR in which the selected pattern is used. The assigned key and the specified track are shown.

✓ 5–1: Page Menu Commands

- Compare →p.112
- Memory Status →p.521
- Exclusive Solo →p.113
- Step Recording (Loop Type) →p.551
- Event Edit →p.551
- Pattern Parameter →p.551
- Erase Pattern →p.551
- Copy Pattern →p.551
- Bounce Pattern →p.552
- Get From MIDI Track →p.552
- Put To MIDI Track →p.552
- Copy To MIDI Track →p.553
- FF/REW Speed →p.523
- PAGE →p.126
- MODE →p.126

5-2: Pattern Name

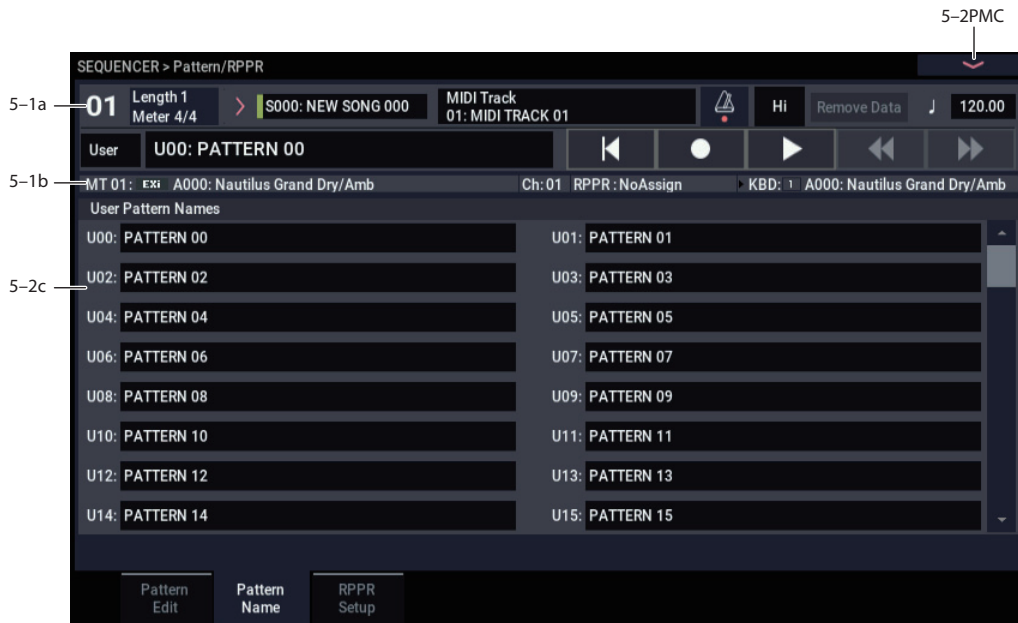

5-2a: User Pattern Names

Pattern name [U00...U99]

Here you can rename the pattern.

Press the text edit button to open the dialog box, and set the name as desired (up to 24 characters). If a USB QWERTY keyboard (commercially available) is connected, you can use this to enter text instead of the on-screen keyboard. For more information, see “Editing names and entering text” on page 206 of the OG.

✓ 5-2: Page Menu Commands

- Compare →p.112
- Memory Status →p.521
- Exclusive Solo →p.113
- Step Recording (Loop Type) →p.551
- Event Edit →p.551
- Pattern Parameter →p.551
- Erase Pattern →p.551
- Copy Pattern →p.551
- Bounce Pattern →p.552
- Get From MIDI Track →p.552
- Put To MIDI Track →p.552
- Copy To MIDI Track →p.553
- FF/REW Speed →p.523
- PAGE →p.126
- MODE →p.126

5-3: RPPR Setup



Here you can make settings for the RPPR (Realtime Pattern Play/Recording) function. RPPR lets you assign patterns to individual keys, and then playback patterns simply by pressing individual notes on the keyboard. This performance can be recorded in real-time.

For each song, you can assign either a preset pattern or a user pattern to each of the 72 keys in the range C#2–C8. For each key, you can specify the pattern, track number, and how the pattern will be played.

Keys used to play patterns via RPPR cannot be used for Arpeggiator. If RPPR is on, keys to which a pattern is not assigned will play the program of the track that's selected in **Track Select**. In this case, ARP will operate if Arpeggiator A or B is assigned to the track and turned on. Also, notes generated by ARP will not trigger the RPPR function.

When Local Control is OFF ("Local Control On" Global 1-1a), the keyboard will not trigger RPPR pattern playback. Notes received at MIDI IN on the channel of the track currently selected by **Track Select** will trigger patterns. If you have recorded only the trigger notes on an external sequencer and wish to use the playback from the external sequencer to trigger RPPR patterns on NAUTILUS, set Local Control OFF.

If you want the note data generated by RPPR to be recorded by the external sequencer, set Local Control ON, and turn off the echo back function of the external sequencer. See "Local Control On settings" on page 930.

In the RPPR Setup page, RPPR is turned on automatically. This will be the same result as when the RPPR check box (0-1a) in each page is checked.

5-3a: Song Select, Track Select, Tempo

Song Select [00...199: name]

Selects the desired song. The RPPR settings will be assigned to the song you select here.

Track Select [MIDI Track01...MIDI Track16, Master Track, Audio Track01...Audio Track16]

When you play a key that is not assigned to RPPR, it will sound using the settings of the track that's selected in **Track Select**. Use this to select the track that you want to play together with RPPR, or to audition a pattern before you assign it. The program bank, number, and name of the selected track is shown at the right.

Each RPPR pattern will begin playing when you press the assigned key, regardless of the **Track Select** setting. It will sound using the settings of the track selected in "Track Name."

The Master Track and Audio Track 01-16 settings are ignored. The last-selected MIDI Track 01-16 will be used.

Tempo [040.00...300.00, EXT]

Specifies the playback tempo of the patterns. (0-1a)

5-3b: KEY, Keyboard & Assigned Graphics

KEY (Key Select) [C#2...C8]

This specifies the key to which you want to assign the RPPR pattern. You can also set the **KEY** by holding down the ENTER button and playing a note on the keyboard, or by simply touching one of the parameters in the RPPR Setup table in the bottom half of the display.

Keyboard & Assigned Graphics

This shows the selected key, and the keys to which a pattern has been assigned by the RPPR function. See diagram below.

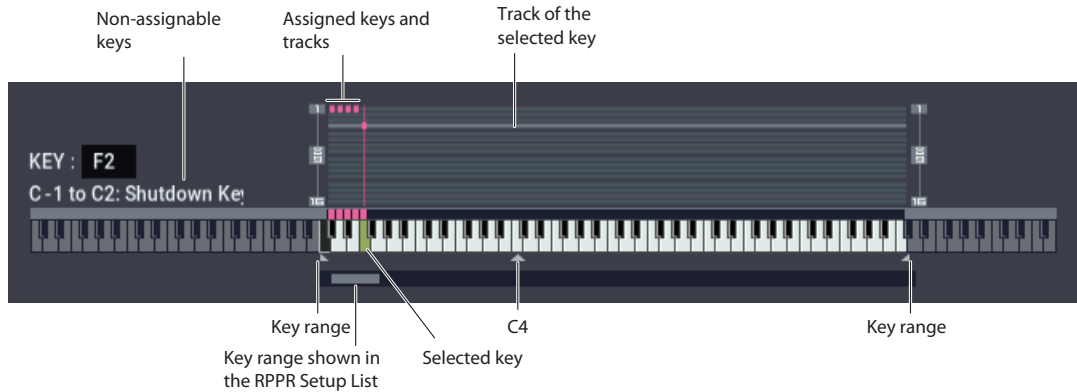

5-3c: RPPR Setup

(KEY) [C#2...C8]

The current KEY is shown by a small, red triangle to the left of the row.

Assign [Off, On]

On (checked): When you play the note specified by KEY, the pattern selected in Pattern will be triggered.

Off (unchecked): That key will sound the currently selected track at the corresponding pitch, just as in normal SEQUENCER mode.

Pattern Bank [Preset, User]

Pattern [P000...718, U00...99]

Selects the RPPR pattern for the key selected in KEY. If the selected user pattern contains no musical data, there will be no sound when you press that key.

Track [MIDI Track 01...MIDI Track16]

Selects the track that will be used for the RPPR pattern selected for the KEY. When you play the key, the pattern will be played according to the settings of the track you select here. You can make track settings in the Home- MIDI Filter/Zones pages.

When you record in realtime with the RPPN function turned on, the data will be recorded on the track you select here. For details, see "Recording an RPPR performance" on page 108 of the OG.

"Information" shows the bank, name, and number of the program that's selected for **Track**.

Mode [Once, Manual, Endless]

Specifies the way in which the pattern assigned to the specified KEY will be played.

Once: When you press the key, the complete pattern will playback once to the end and then stop.

Manual: The pattern will continue repeating as long as you continue holding the key, and will stop as soon as you release the key.

Endless: The pattern will continue repeating even after you release the key. To stop the pattern playback, press any note below C2, or press the same key once again.

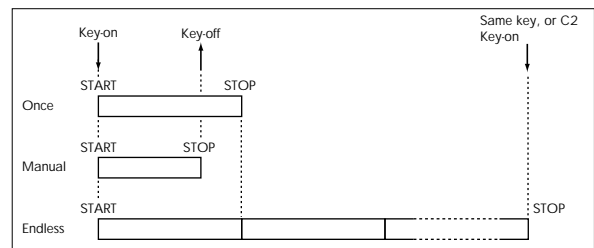

Shift [-12...+12]

Adjusts the playback pitch of the pattern for the specified KEY in semitone steps over a range of ±1 octave.

With a setting of 0, the pattern will be played at its original pitch.

Sync [Off, Beat, Measure, SEQ]

Specifies the way in which the pattern playback will be synchronized when you press the specified KEY.

Off: The pattern will begin playing at the moment you press the note.

Beat: The pattern will synchronize to the beats of the pattern that was started by the first key (i.e., the first note-on that occurs from a condition where no notes of the keyboard are pressed). This setting is suitable when you wish to play phrase patterns in unison.

Measure: The pattern will synchronize to the measures of the pattern that was started by the first key. This setting is suitable for rhythm, bass or drum patterns.

SEQ: The pattern will synchronize to the measures of the sequencer song.

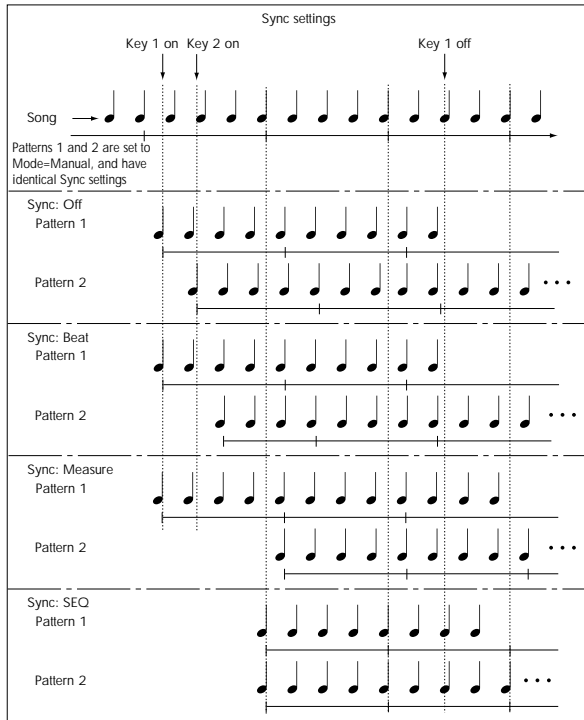

- When Beat or Measure are selected, pattern playback will begin when you press the first key. The second and subsequent patterns that are triggered from the keyboard will synchronize to the pattern that was started by the first key; with a setting of Beat they will synchronize in steps of a beat, and with a setting of Measure they will synchronize in steps of a measure.
- When SEQ is selected, the pattern will playback in synchronization with the measures of the sequencer song. The pattern will synchronize with the currently-playing song, so you must start the song before you play notes on the keyboard.
- Beat, Measure, and SEQ will cause the pattern to start immediately if you play the key within a thirty-second note of the timing of the respective beat or measure, but if you play the key later than this, the start of the pattern will be delayed by a beat.

Information

This area shows the bank, name, and number of the program that's selected for the track.

Stopping playback of a RPPR pattern

By pressing C2 (or any note lower than C2), all the patterns being played by RPPR will stop.

The patterns of keys whose Sync setting is Off will stop immediately, but the playback of other keys will stop at the beginning of the next beat or measure. Pattern playback of keys whose Sync setting is other than Off can be stopped immediately by rapidly pressing C2 or any lower note twice in succession.

Copy

This copies the Assign, Pattern Bank, Pattern, Track, Mode, Shift, and Sync settings of the selected KEY into a copy buffer.

Paste

This pastes the settings from the copy buffer (obtained by Copy) into the selected KEY.

Example: Assigning Patterns to Keys

Before you begin, assign a drum Program to MIDI track 1.

1. Touch the Assign box for C#2, so that it's enabled. Set the Pattern Bank to Preset, the Pattern to P001, and the Track to MIDI Track 01.

Since you've been working with C#2's parameters, the KEY will be set to C#2.

2. With KEY still set to C#2, press Copy.

| | Assign | Bank | Pattern Name | Track Name |
|-------|-------------------------------------|--------|-------------------------|------------|
| ► C#2 | <input checked="" type="checkbox"/> | Preset | P001: 16 Beat 01 BPM114 | T01: Kick |
| D2 | <input type="checkbox"/> | User | U00: PATTERN 00 | T01: Kick |
| D#2 | <input type="checkbox"/> | User | U00: PATTERN 00 | T01: Kick |
| E2 | <input type="checkbox"/> | User | U00: PATTERN 00 | T01: Kick |
| F2 | <input type="checkbox"/> | User | U00: PATTERN 00 | T01: Kick |
| F#2 | <input type="checkbox"/> | User | U00: PATTERN 00 | T01: Kick |

Copy Paste

3. Touch the Pattern Name for D2, and then press the Paste button.

The Assign, Pattern Bank, Pattern, Track, Mode, Shift, and Sync settings from step 1 will be copied into D2.

4. With D2's Pattern Name still selected, press the + button to change it to P002.

5. Touch D#2's Pattern Name, and then press the Paste button.

The settings from step 1 will be copied into D#2.

6. Similar to step 4, set D#2's Pattern to P003.

As you can see, if the patterns that you want to assign to the keys are numbered consecutively (or are nearby each other), and use the same track, Copy and Paste can really speed up the process of assigning patterns to keys.

✓ **5-3: Page Menu Commands**

- Compare →p.112
- Memory Status →p.521
- Exclusive Solo →p.113
- PAGE →p.126
- MODE →p.126

SEQUENCER > IFX

You can also specify the bus routing for the program used by each MIDI track 1–16 and audio track 1–16. For instance, you can:

- Send the output of a track to an insert effect
- Route a sound to an insert effect

- Make detailed settings for insert effects
- Make common LFO settings for effects

For details on Insert Effects, see “Effect Guide” on page 731.

8-1: MIDI Routing1



Specifies the bus to which the program oscillator(s) used by each MIDI track 1–16 will be sent. You can also set the send levels to the master effects from this page.

8-1a: Routing Map

This area shows the insert effect routing, the name of the assigned effect, the on/off status, chaining, and the output bus that follows the insert effect. The type of insert effect, the on/off status, and the chain settings can be edited in the IFX– Insert FX page.

8-1b: MIDI Routing1

Track 01 (Track Number)

Bus Select (IFX/Indiv. Out Assign) Dkit [Off, On]

You can select this only if the specified program is a drum program (Oscillator Mode Drums or Double Drums).

This parameter can also be edited from the IFX– MIDI Routing 2 page.

On (checked): The Bus Select (IFX/Indiv.Out Assign), FX Control Bus, Send1 (to MFX1), and Send2 (to MFX2) settings for each key of the selected drum kit will be used. Check this setting if you want to apply an individual insert effect to each drum instrument, or to send individual drum instruments to AUDIO OUTPUT (INDIVIDUAL).

Tip: In most preloaded drumkits, the drum instruments have the same **Bus Select** settings according to their type, as follows.

- Snares → IFX1
- Kicks → IFX2
- Toms → IFX3
- Cymbals → IFX4
- Percussion etc. → IFX5

If you want to edit these routings, use the “Drum Kit IFX Patch” page menu command. For details, see “Drum Kit IFX Patch” on page 438.

Off (unchecked): The Bus Select, FX Control Bus, and Send 1/2 settings will be used. All drum instruments will be sent to the specified bus.

Bus Select (IFX/Indiv.Out Assign)

[L/R, IFX1...12, 1...4, 1/2...3/4, Off]

This specifies the output bus for the track’s program oscillator. This parameter can also be edited from the IFX– MIDI Routing 2 page.

L/R: Output to the L/R bus.

IFX1...12: Output to the IFX1–12 buses.

1...4: The track will be output in mono from the corresponding AUDIO OUTPUT (INDIVIDUAL).

1/2...3/4: The track will be output in stereo according to its pan setting from the corresponding AUDIO OUTPUT (INDIVIDUAL) pairs.

Off: The track will not be output from the L/R bus, IFX1–12 buses, or Individual 1–4 buses. Choose the Off setting if you want the program oscillator output of the track to be connected in series to a master effect. Use **Send1 (to MFX1)** and **Send2 (to MFX2)** to specify the send levels.

Tip: You can create a wide variety of routings by using each track's **Bus Select** and the **Chain to** and **Chain** settings (8–5a) that follow the insert effect.

Send1 (MFX1) [000...127]

Send2 (MFX2) [000...127]

For each track, these parameters set the send level to master effects 1 and 2. These settings are valid when **Bus Select** is set to L/R or Off. When IFX 1–12 are selected, the send levels to master effects 1 and 2 are set by the **Send1** and **Send2** parameters of the Insert FX page, after the sound has passed through IFX1–12.

If **Bus Select** is set to 1...4 or 1/2...3/4, these settings are ignored.

The Send 1 and 2 setting you specify here are used when playing-back or recording from the beginning of the song. If you modify these settings during recording, your changes will be recorded as performance data; the send amounts will change accordingly during playback. You can also modify these settings during playback. However if Send 1 and 2 data has been recorded, the settings will change according to the recorded data.

MIDI If **Status** (2–1a) is either INT or Both, CC#93 and #91 can be received to control send 1 and 2 respectively and change their settings. When you switch songs or return to the beginning of a song, tracks whose **Status** is EXT, EX2 or Both will transmit these settings via MIDI. This data will be transmitted on the MIDI channel of each track as set by **MIDI Channel** (2–1a). The actual send level is determined by multiplying the value of these parameters with the send level settings of the oscillator(s) of the program used by the track (**Send1** and “Send2,” Program 8–1d).

Track 02...16 (Track Number)

These settings specify the program oscillator output bus and master effect send levels for MIDI tracks 2 through 16. They are the same as for track 1. See “Track 01”:

✓ 8–1: Page Menu Commands

- Compare →p.112
- Memory Status →p.521
- Exclusive Solo →p.113
- Copy Insert Effect →p.122
- Swap Insert Effect →p.123
- Drum Kit IFX Patch →p.438
- Put Effect Setting to Track →p.554
- FF/REW Speed →p.523
- Set Location (for Locate Key) →p.523

- PAGE →p.126
- MODE →p.126

8-2: MIDI Routing2

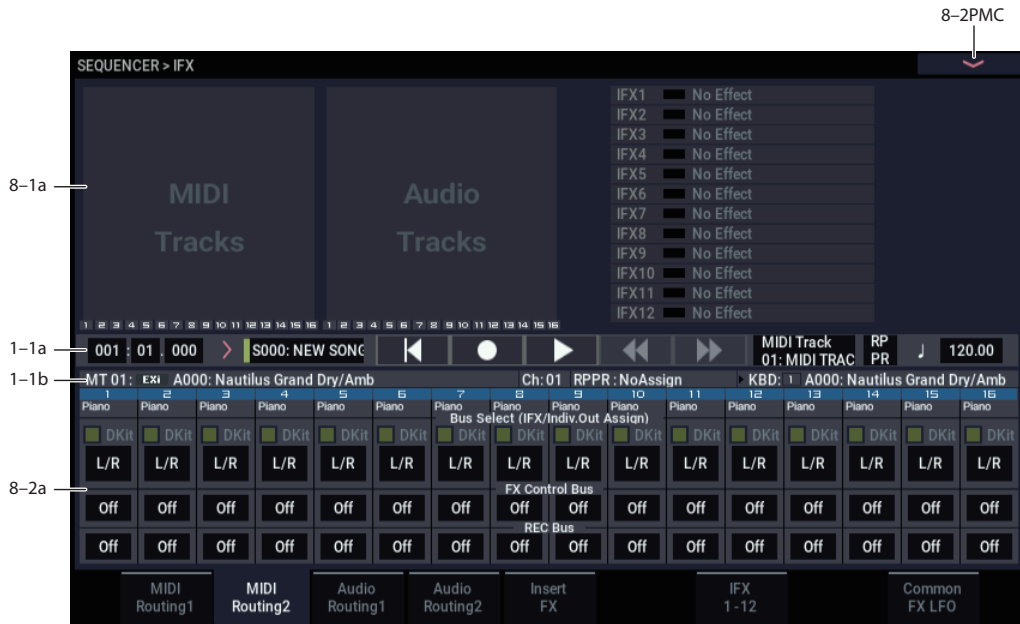

Here you can specify the program oscillator output bus, effect control bus, and REC bus for each MIDI track 1 through 16.

8-2a: MIDI Routing2

Track 01 (Track Number)

Bus Select (IFX/Indiv. Out Assign) Dkit [Off, On]

You can select this only if the specified program is a drum program (**Oscillator Mode Drums**). These settings can also be made in the Insert Effect-Routing1. For more information, please see “Bus Select (IFX/Indiv. Out Assign) Dkit” on page 507.

Bus Select (IFX/Indiv. Out Assign)

[L/R, IFX1...12, 1...4, 1/2...3/4, Off]

For each track, these parameters specify the bus to which the program oscillator(s) will be sent. The current settings can also be viewed in the Routing Map. This parameter can also be edited from the IFX– MIDI Routing1 page. For more information, please see “Bus Select (IFX/Indiv. Out Assign)” on page 507.

FX Control Bus [Off, 1, 2]

Sends the output of the track to an FX Control bus (two-channel stereo FX Ctrl 1 or 2).

Use the FX Control buses when you want a separate sound to control the audio input of an effect. You can use two FX Control buses (each is a two-channel stereo bus) to control effects in various ways.

For more information, please see “FX Control Buses” on page 735.

REC Bus (All OSCs to) [Off, 1, 2, 3, 4, 1/2, 3/4]

These settings send the output of the track to the REC buses (four mono channels: 1, 2, 3, 4).

The REC buses are dedicated internal buses for recording, used for sampling in the various modes or for recording audio tracks in SEQUENCER mode. In SEQUENCER mode, you can use these buses to record audio tracks onto the drive, or to sample.

You will normally use audio track recording to record external audio signals such as guitar or vocal that are input from the Audio Input jacks, but you can also record the playback of MIDI tracks or your performance using the keyboard or Arpeggiator function. Use **REC Bus** to send the desired tracks to the REC buses, and select REC1–4 (REC 1/2, 3/4) as the **REC Source** (0–2a) so that the signals sent to the REC buses can be recorded.

You can also resample (mix-down) the song playback onto the drive to create a stereo WAVE file, or sample external audio sources from the Audio Inputs into RAM (the In-Track Sampling function). Use the **REC Bus** setting to send the desired tracks or audio inputs to the REC buses for sampling or resampling, and set **Source Bus** (Home– Sampling - Sampling Setup) to REC1/2 or 3/4 so that these signals can be sampled.

Off: The signal will not be sent to a REC bus. Normally you will leave this off.

1, 2, 3, 4: The output of the track will be sent to the corresponding REC bus. The **Pan** setting (0–1b) of each track will be ignored, and the signal will be sent in monoaural.

1/2, 3/4: The output of the track will be sent in stereo to the corresponding pair of REC buses. The signal is sent in stereo to REC buses 1/2 or 3/4 according to the **Pan** setting (0–1b) of each track.

Track 02... 16 (Track Number)

These settings specify the program oscillator output bus, effect control bus, and REC bus used by MIDI tracks 2 through 16. These are the same as for track 1. See “Track 01”.

✓ 8-2: Page Menu Commands

- Compare →p.112
- Memory Status →p.521
- Exclusive Solo →p.113
- Copy Insert Effect →p.122
- Swap Insert Effect →p.123
- Drum Kit IFX Patch →p.438
- Put Effect Setting to Track →p.554
- FF/REW Speed →p.523
- Set Location (for Locate Key) →p.523

- PAGE →p.126
- MODE →p.126

8-3: Audio Routing1



Here you can specify the buses for the outputs of audio tracks 1–16. You can also adjust the send amounts to the master effects.

Audio tracks 1–16 can be processed by the insert effects, master effects, and total effects, and routed to the desired buses, in the same way as for MIDI tracks 1–16.

8-3a: Audio Routing1

Track 01 (Track Number)

STEREO

This is shown if **Stereo Pair** is on.

Bus Select (IFX/Indiv. Out Assign) [L/R, IFX1...12, 1...4, 1/2...3/4, Off]

This specifies the bus for the audio track. The current settings can also be viewed in the Routing Map. This parameter can also be edited from the IFX– Audio Routing 2 page.

For more information, please see “Bus Select (IFX/Indiv.Out Assign)” on page 507.

Send1 (MFX1) [000...127]

Send2 (MFX2) [000...127]

For each audio track, these parameters set the send level to master effects 1 and 2. These settings are valid when **Bus Select (IFX/Indiv. Out Assign)** is set to L/R or Off. When IFX 1–12 are selected, the send levels to master effects 1 and 2 are set by the **Send1** and **Send2** parameters of the Insert FX page, after the sound has passed through IFX1–12.

If **Bus Select** is set to 1...4 or 1/2...3/4, these settings are ignored.

The Send 1 and 2 setting you specify here are used when playing-back or recording from the beginning of the song. If you modify these settings during recording, your changes will be recorded as automation event; the send amounts will

change accordingly during playback. You can also modify these settings during playback. However if Send 1 and 2 data has been recorded, the settings will change according to the recorded data.

Track 02... 16 (Track Number)

Here you can specify the output bus and master effect send amount for each audio track 2 through 16. These are the same as for track 1. See “Track 01”.

✓ 8-3: Page Menu Commands

- Compare →p.112
- Memory Status →p.521
- Exclusive Solo →p.113
- Copy Insert Effect →p.122
- Swap Insert Effect →p.123
- Stereo Pair →p.525
- Put Effect Setting to Track →p.554
- FF/REW Speed →p.523
- Set Location (for Locate Key) →p.523
- PAGE →p.126
- MODE →p.126

8-4: Audio Routing2



Here you can specify the buses, effect control bus, and REC bus for the outputs of audio tracks 1-16.

8-4a: Audio Routing2

Track 01 (Track Number)

STEREO

This is shown if **Stereo Pair** is on.

Bus Select (IFX/Indiv.Out Assign)

[L/R, IFX1...12, 1...4, 1/2...3/4, Off]

This specifies the bus for the audio track. The current settings can also be viewed in the Routing Map. This parameter can also be edited from the IFX- Audio Routing 1 page. For more information, please see “Bus Select (IFX/Indiv.Out Assign)” on page 507.

FX Control Bus

[Off, 1, 2]

Sends the output of the audio track to an FX Control bus (two-channel stereo FX Ctrl 1 or 2).

For more information, please see “FX Control Bus” on page 509. For examples, see “FX Control Buses” on page 735.

REC Bus

[Off, 1, 2, 3, 4, 1/2, 3/4]

These settings send the output of the audio track to the REC buses (four mono channels: 1, 2, 3, 4). For more information, please see “REC Bus (All OSCs to)” on page 509.

Track 02...16 (Track Number)

Here you can specify the output bus, effect control bus, and REC bus for audio tracks 2 through 16. These are the same as for track 1, above.

✓ 8-4: Page Menu Commands

- Compare →p.112
- Memory Status →p.521
- Exclusive Solo →p.113
- Copy Insert Effect →p.122
- Swap Insert Effect →p.123
- Stereo Pair →p.525
- Put Effect Setting to Track →p.554
- FF/REW Speed →p.523
- Set Location (for Locate Key) →p.523
- PAGE →p.126
- MODE →p.126

8-5: Insert FX



8-5a: IFX

Here you can choose the type of each insert effect 1 through 12, its on/off status, chaining, and adjust the post-IFX mixer settings. Meters below the IFX labels display the effect output levels in realtime, showing the combined peak signals of the left and right channels.

For insert effects, the direct sound (Dry) is always stereo-in and out. The input/output configuration of the effect sound (Wet) depends on the effect type. For descriptions of the individual effects, please see “Effect Guide,” beginning on page 731.

The following parameters are the same as in PROGRAM mode. For details, see “8-5a: IFX” on page 101.

However, unlike in PROGRAM mode, insert effect dynamic modulation (Dmod) and the post-IFX **Pan (CC#8)**, **Send1**, and **Send2** are controlled on the MIDI channel specified by “Ch” (8-7a). The control changes used are the same as in PROGRAM mode.

The pan (CC#8), send 1 and 2 settings you make here will be used when the song is played or recorded from the beginning. If you change the settings while recording a MIDI track, the changes will be recorded as part of the musical data, and the settings will change when the data is played back. You can also change these settings during playback. However if pan (CC#8), send 1, or 2 data has been recorded, the settings will change accordingly.

MIDI If **Status** (2-1a) is either INT or Both, CC#8, CC#93, and CC#91 can be received to control the pan following the insert effect, send 1, or send 2 respectively, and change their settings. When you switch songs or return to the beginning of the song, tracks whose **Status** is Both, EXT, or EX2 will transmit these settings via MIDI. This data will be transmitted on the MIDI channels specified in the IFX 1-12 pages (8-7).

IFX1

| | |
|-------------------------------------|------------------------------|
| IFX1 | [000...197] |
| IFX1 On/Off | [Off, On] |
| Chain to | [IFX2...IFX12] |
| Chain | [Off, On] |
| Pan(CC#8) (Post IFX PanCC#8) | [L000...C064...R127] |
| Bus Sel. (Bus Select) | [L/R, 1...4, 1/2...3/4, Off] |
| Ctrl Bus (FX Control Bus) | [Off, 1, 2] |
| REC Bus | [Off, 1, 2, 3, 4, 1/2, 3/4] |
| Send1 | [000...127] |
| Send2 | [000...127] |

IFX2...12

These parameters specify the type of each insert effect, its on/off status, chaining, and post-IFX mixer settings. With the exception of **Chain to** and **Chain**, the parameters are the same as for IFX1. For more information, please see “IFX1” on page 101.

| | |
|------------------------|------------------------|
| IFX2: Chain to | [IFX3...IFX12] |
| IFX3: Chain to | [IFX4...IFX12] |
| IFX4: Chain to | [IFX5...IFX12] |
| IFX5: Chain to | [IFX6...IFX12] |
| IFX6: Chain to | [IFX7...IFX12] |
| IFX7: Chain to | [IFX8...IFX12] |
| IFX8: Chain to | [IFX9...IFX12] |
| IFX9: Chain to | [IFX10...IFX12] |
| IFX10: Chain to | [IFX11...IFX12] |
| IFX11: Chain to | [(IFX12)] |

✓ 8-5: Page Menu Commands

- Compare →p.112
- Memory Status →p.521
- Exclusive Solo →p.113
- Copy Insert Effect →p.122
- Swap Insert Effect →p.123
- Insert IFX Slot →p.123
- Cut IFX Slot →p.124
- Clean Up IFX Routings →p.124
- Put Effect Setting to Track →p.554
- FF/REW Speed →p.523
- Set Location (for Locate Key) →p.523
- PAGE →p.126
- MODE →p.126

8-7: IFX 1-12

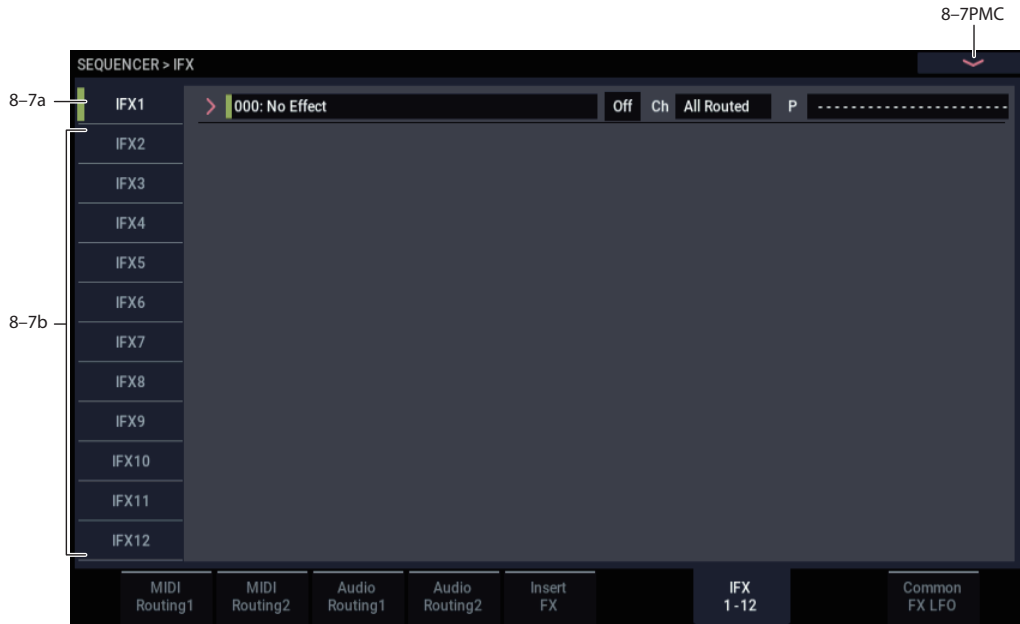

This page lets you edit the parameters of the insert effect 1. Use the tabs at left to select IFX1 through IFX12.

Effects Modulation: Dmod

Most effects have one or more parameters which can be modulated in realtime. In the NAUTILUS, this is called Dynamic Modulation, or Dmod for short.

For a complete list of Dmod sources, see “Dynamic Modulation Source List” on page 912.

MIDI You can use different MIDI channels to control Dmod for each effect, if desired, as selected by the **Ch (Control Channel)** parameter.

8-7a: IFX1

This configures the parameters of insert effect 1. Use the tabs at left to select IFX1 through IFX12.

IFX Type

This selects the effect type for insert effect 1.

IFX1 On/Off [Off, On]

Turns the insert effect on/off. This is linked with the on/off setting in the IFX- Insert FX page.

Ch (Control Channel) [Ch01...16, All Routed]

This parameter specifies the MIDI channel that will be used to control effect dynamic modulation (Dmod), pan following the insert effect (CC#8), Send 1, and Send 2.

The channel number of the MIDI track routed through this IFX will be followed by a “*” displayed at the right of Ch01-16. If two or tracks with different MIDI channel settings are routed through the same IFX, this parameter specifies which of these channels will be used to control the effect.

Note: If you want to control an IFX to which an audio track is routed, use a MIDI track whose channel matches the “Ch (Control Channel)” of the effect you want to control.

All Routed: The channel of any MIDI track routed through this effect can be used to control the effect. (Channels of each routed track will be indicated by “*”.)

Drum Kits and the MIDI Control Channel

If a Timbre is using a Drum Kit, and the Timbre’s **Bus Select (IFX/Indiv. Out Assign) DKit** (8-1b) is enabled, this affects the MIDI Control Channel as well. In this case, the Timbre’s MIDI channel will be used to control any effect whose **Ch** is set to All Routed, regardless of the **Bus Select (IFX/Indiv.Out Assign)** (GLOBAL 4-3b) settings or the settings of the **DrumKit IFX Patch** page menu command.

P (Effect Preset) [P00, P01...15, U00...15, -----]

This selects the effect preset.

For more information, please see “Effect preset function” on page 103.

IFX1 Parameters

Set the parameters for the effect type selected for insert effect 1.

For more information, please see “Insert Effects (IFX1...IFX12)” on page 739.

8-7b: IFX2...12

This configures the parameters of insert effects 2-12.

The parameters for IFX2 through IFX12 are the same as for IFX1. For more information, please see “8-7a: IFX1” on page 515.

✓ 8-7: Page Menu Commands

- Compare →p.112
- Memory Status →p.521
- Exclusive Solo →p.113
- Copy Insert Effect →p.122
- Swap Insert Effect →p.123
- Write FX Preset →p.126
- Put Effect Setting to Track →p.554
- FF/REW Speed →p.523
- Set Location (for Locate Key) →p.523

- PAGE →p.126
- MODE →p.126

8–9: Common FX LFO

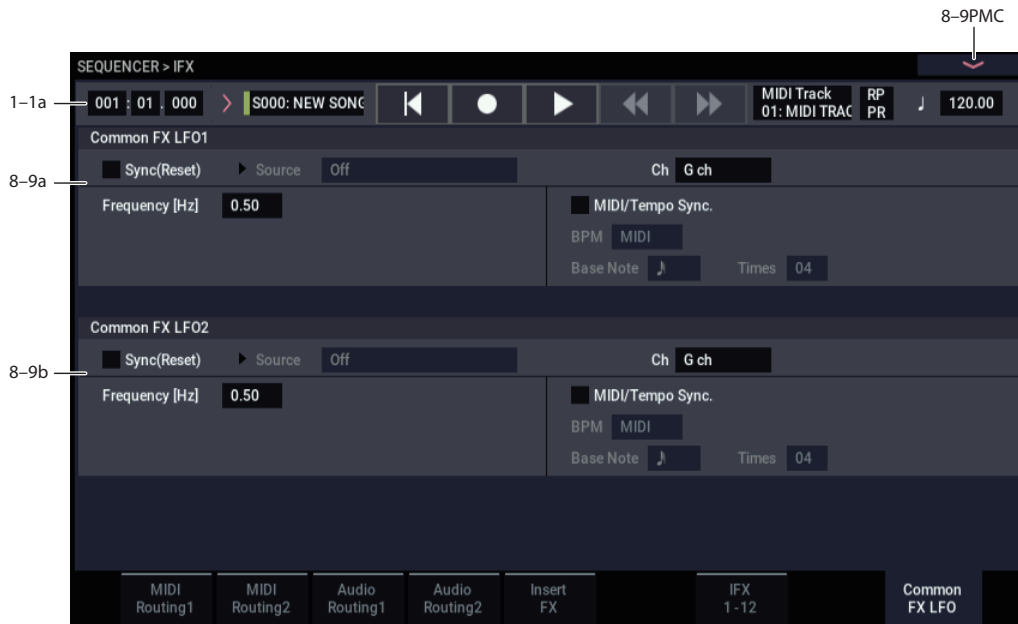

The two Common FX LFOs allow you to synchronize LFO-based modulation for multiple effects, such as phasers, flangers, filters, and so on.

The Common LFOs control only the frequency, MIDI synchronization, and reset options; each individual effect still has its own settings for the LFO waveform and phase.

Within the individual effects, you can choose whether to use one of the Common LFOs, or to use the individual effect’s frequency, sync, and/or reset settings instead. This is done via the effect’s **LFO Type** parameter; select **Individual** to use the effect’s settings, or **Common 1** or **2** to use the Common LFOs.

8–9a: Common FX LFO1

Ch (Control Channel) [Ch01...Ch16, Gch]

Specifies the MIDI channel that will control dynamic modulation (Dmod) for Common LFO 1 and 2.

G ch: The global **MIDI channel** (GLOBAL 1–1a) will be used for control. This is the default setting.

Sync (Reset) [Off, On]

Source (Dmod Source) [List of Dmod Sources]

Frequency [0.02...20.00 (Hz)]

MIDI/Tempo Sync [Off, On]

BPM [MIDI, 40.00...300.00]

Base Note [Musical notation]

Times [01...32]

These parameters are the same as in PROGRAM mode. For more information, please see “8–9a: Common FX LFO1” on page 105.

8–9b: Common FX LFO2

These parameters are the same as for Common FX LFO1. For more information, please see “8–9a: Common FX LFO1,” above.

✓ 8–9: Page Menu Commands

- Compare →p.112
- Memory Status →p.521
- Exclusive Solo →p.113
- Copy Insert Effect →p.122
- Swap Insert Effect →p.123
- Put Effect Setting to Track →p.554
- FF/REW Speed →p.523
- Set Location (for Locate Key) →p.523
- PAGE →p.126
- MODE →p.126

SEQUENCER > MFX/TFX

Here you can make settings for the master effects and total effects. For more information, please see “Effect Guide” on page 731.

9-1: Routing

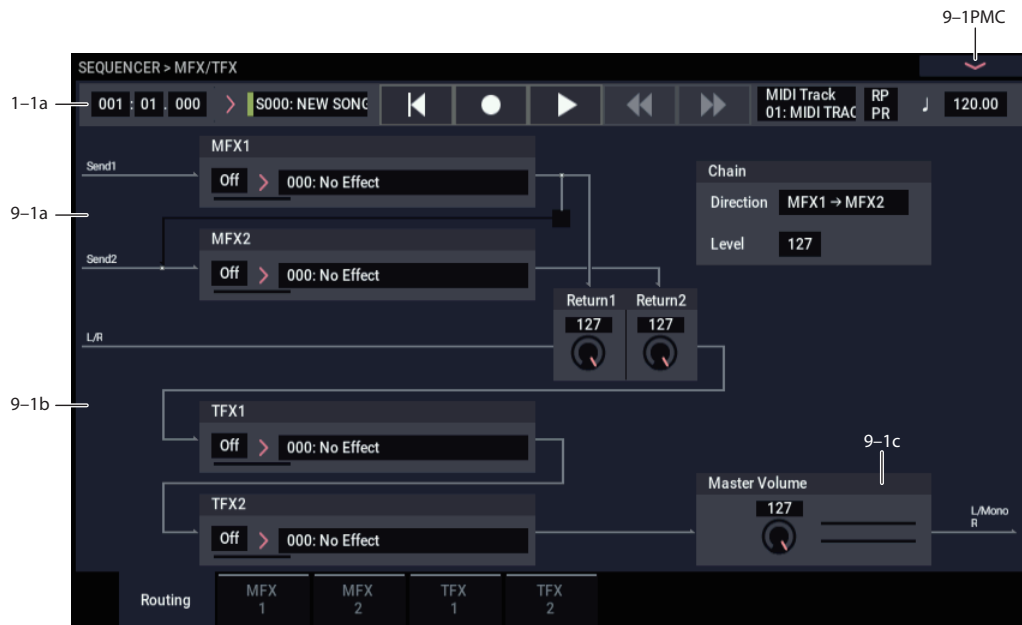

Here you can specify the type of master effects and total effects, and turn them on/off. The meters below the effects names display the effect output levels in realtime, showing the combined peak signals of the left and right channels.

The master effects are sent to the L/R bus. The total effects are inserted into the L/R bus.

These parameters are the same as in PROGRAM mode. For more information, please see “9-1: Routing” on page 107.

9-1a: MFX1, 2

MFX1:

| | |
|--------------------|-------------|
| MFX1 | [000...197] |
| MFX1 On/Off | [Off, On] |
| Return 1 | [000...127] |

MFX2:

| | |
|--------------------|-------------|
| MFX2 | [000...197] |
| MFX2 On/Off | [Off, On] |
| Return 2 | [000...127] |

Chain:

| | |
|------------------------|------------------------|
| Chain On/Off | [Off, On] |
| Chain Direction | [MFX1→MFX2, MFX2→MFX1] |
| Chain Level | [000...127] |

9-1b: TFX1, 2

TFX1:

| | |
|--------------------|-------------|
| TFX1 | [000...197] |
| TFX1 On/Off | [Off, On] |

TFX2:

| | |
|--------------------|-------------|
| TFX2 | [000...197] |
| TFX2 On/Off | [Off, On] |

9-1c: Master Volume

| | |
|----------------------|-------------|
| Master Volume | [000...127] |
|----------------------|-------------|

✓ 9-1: Page Menu Commands

- Compare →p.112
- Memory Status →p.521
- Exclusive Solo →p.113
- Copy MFX/TFX →p.125
- Swap MFX/TFX →p.125
- Put Effect Setting to Track →p.554
- FF/REW Speed →p.523
- Set Location (for Locate Key) →p.523

- PAGE →p.126
- MODE →p.126

9-2: MFX1

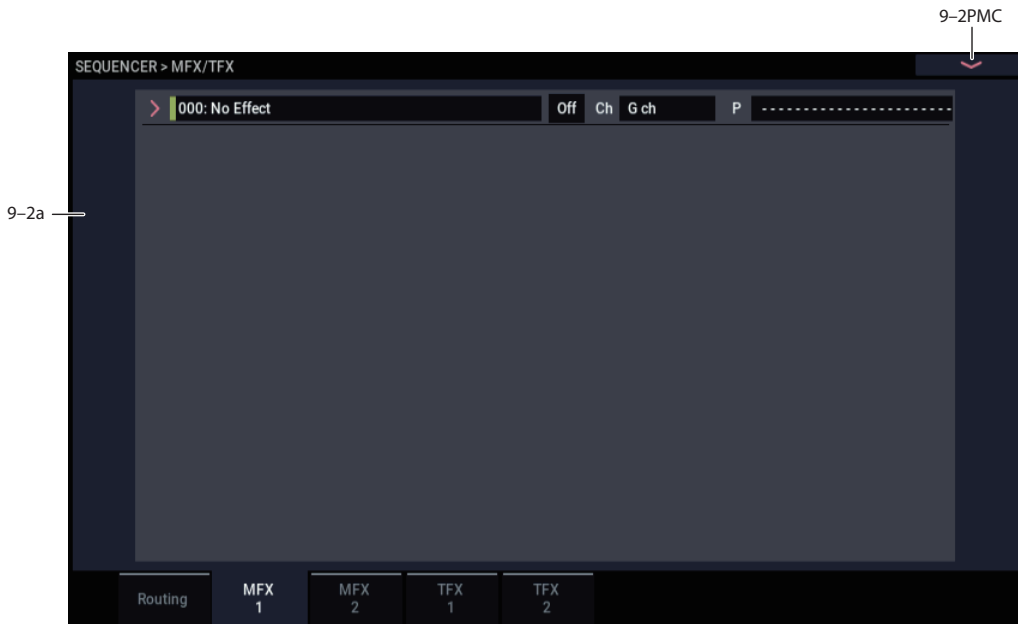

Here you can edit the parameters of the Master Effect 1.

Effects Modulation: Dmod

Most effects have one or more parameters which can be modulated in realtime. In the NAUTILUS, this is called Dynamic Modulation, or Dmod for short.

For a complete list of Dmod sources, see “Dynamic Modulation Source List” on page 912.

MIDI You can use different MIDI channels to control Dmod for each effect, if desired, as selected by the **Ch (Control Channel)** parameter.

9-2a: MFX1

MFX1 On/Off [Off, On]

This turns master effect 1 on/off. This is linked with the on/off setting in the MFX/TFX- Master/Total Effect - Routing page.

Ch (Control Channel) [Ch01...16, G ch]

Specifies the MIDI channel that will control dynamic modulation (Dmod) for the master effect.

Ch01...Ch16: The specified MIDI channel will be used for control.

G ch: The global **MIDI Channel** (GLOBAL 1-1a) will be used for control. Normally you will use the G ch setting.

P (Effect Preset) [P00, P01...15, U00...15, -----]

This selects the effect preset.

For more information, please see “Effect preset function” on page 103.

MFX1 Parameters

Here you can set the effect type parameters selected in the master effect 1.

For details on the individual effects, please see the “Effect Guide” on page 731.

✓ 9-2: Page Menu Commands

- Compare →p.112
- Memory Status →p.521
- Exclusive Solo →p.113
- Copy MFX/TFX →p.125
- Swap MFX/TFX →p.125
- Write FX Preset →p.126
- Put Effect Setting to Track →p.554
- FF/REW Speed →p.523
- Set Location (for Locate Key) →p.523
- PAGE →p.126
- MODE →p.126

9-3: MFX2

9-4: TFX1

9-5: TFX2

These pages let you edit the parameters of Master Effect 2 and Total Effects 1 and 2. To select different effects types, use the P9- Routing page.

The parameters of MFX2, TFX1, and TFX2 are the same as for MFX1. For more information, please see “9-2: MFX1” on page 519.

SEQUENCER: Page Menu Commands

| | | | |
|--|--------|-----------------------------|--------|
| Compare | →p.112 | Load Drum Track Pattern | →p.553 |
| Memory Status | →p.521 | Copy External Scene | →p.122 |
| Exclusive Solo | →p.113 | Copy Scene | →p.122 |
| Rename Song | →p.521 | Swap Scene | →p.122 |
| Initialize Song | →p.522 | Copy Insert Effect | →p.122 |
| Copy From Song | →p.522 | Swap Insert Effect | →p.123 |
| Load Template Song | →p.522 | Insert IFX Slot | →p.123 |
| Save Template Song | →p.523 | Cut IFX Slot | →p.124 |
| FF/REW Speed | →p.523 | Clean Up IFX Routings | →p.124 |
| Set Location (for Locate Key) | →p.523 | Drum Kit IFX Patch | →p.438 |
| GM Initialize | →p.523 | Copy MFX/TFX | →p.125 |
| Copy from Combi | →p.525 | Swap MFX/TFX | →p.125 |
| Copy From Program | →p.525 | Write FX Preset | →p.126 |
| Stereo Pair | →p.525 | Put Effect Setting to Track | →p.554 |
| Optimize RAM | →p.114 | PAGE | →p.126 |
| Select Sample No. | →p.526 | MODE | →p.126 |
| Select Directory/File for Sample To Disk | →p.115 | | |
| Auto HDR/Sampling Setup | →p.527 | | |
| Bounce All Tracks To Disk | →p.532 | | |
| Copy Tone Adjust | →p.118 | | |
| Reset Tone Adjust | →p.119 | | |
| Show EQ Graphic | →p.532 | | |
| Erase Drum Track Pattern | →p.553 | | |
| Copy X-Y Envelope | →p.119 | | |
| Detune BPM Adjust | →p.437 | | |
| MIDI Step Recording | →p.532 | | |
| MIDI Event Edit | →p.533 | | |
| Audio Event Edit | →p.535 | | |
| Audio Automation Edit | →p.538 | | |
| Set Song Length | →p.538 | | |
| Erase Track | →p.539 | | |
| Copy Track | →p.539 | | |
| Bounce Track | →p.539 | | |
| Erase Measure | →p.540 | | |
| Delete Measure | →p.541 | | |
| Insert Measure | →p.541 | | |
| Repeat Measure | →p.542 | | |
| Copy Measure | →p.543 | | |
| Move Measure | →p.544 | | |
| Create Control Data | →p.544 | | |
| Erase Control Data | →p.545 | | |
| Quantize | →p.545 | | |
| Shift/Erase Note | →p.546 | | |
| Modify Velocity | →p.547 | | |
| Region Edit | →p.547 | | |
| Volume Ramp | →p.549 | | |
| Copy Song's Tempo to Region | →p.550 | | |
| Adjust Song's Tempo to Region | →p.550 | | |
| Adjust Region to Song's Tempo | →p.550 | | |
| Step Recording (Loop Type) | →p.551 | | |
| Event Edit | →p.551 | | |
| Pattern Parameter | →p.551 | | |
| Erase Pattern | →p.551 | | |
| Copy Pattern | →p.551 | | |
| Bounce Pattern | →p.552 | | |
| Get From MIDI Track | →p.552 | | |
| Put To MIDI Track | →p.552 | | |
| Copy To MIDI Track | →p.553 | | |
| Convert to Drum Track Pattern | →p.553 | | |

Memory Status

If you select “Memory Status,” the remaining amount of sequencer memory will be displayed.

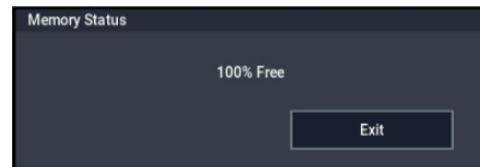

Exclusive Solo

This specifies how the Solo function will operate. Each time you select “Exclusive Solo,” the setting will alternate between multiple solo and exclusive solo. For details, see “Exclusive Solo” on page 113.

Rename Song

Here you can rename the selected song. You can enter a name of up to 24 characters. For more information, see “Editing names and entering text” on page 206 of the OG.

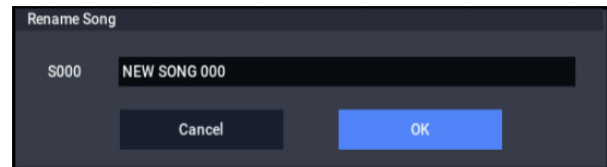

Initialize Song

This command erases all data in the current song, and restores all parameters to their default states. It's convenient for clearing Song locations if you receive the "Not enough song locations available" error message.

WAV files and their regions will not be deleted. If you want to delete this data, use the **Delete Unused WAV Files** command. For more information, see "Delete Unused WAV Files" on page 727.

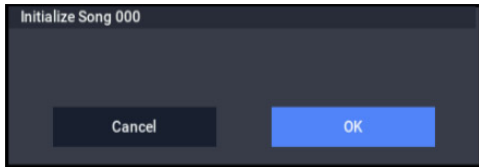

Copy From Song

This command copies all of the setting data and musical data from the specified song to the currently selected song.

1. Select "Copy From Song" to open the dialog box.

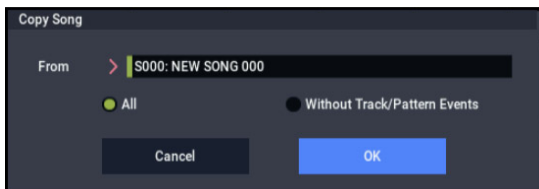

2. In "From," specify the copy source song number.
3. Select the data that you wish to copy.

All: will copy all setting data and musical data (track events and audio events, etc.).

Without Track/Pattern Events: will copy only the setting data of songs, except for Play Loop and RPPR data.

4. To execute the Copy Song operation, press the OK button. To cancel, press the Cancel button.

Be aware that if you execute "All," all setting data and musical data of the currently selected song will be erased and rewritten by the data from the copy source song.

If you execute "Without Track/Pattern Events," song setting data other than Play Loop and RPPR will be rewritten.

Load Template Song

Template Songs store pretty much everything in the Song except for the MIDI and audio data itself. This includes Program selections, track parameters, effects and Arpeggiator settings, and the Song's name and tempo.

The factory preset Template Songs let you get up and running quickly with matched sets of sounds and effects for various styles of music. You can also create your own Template Songs with your favorite sounds and setups.

Note that Template Songs do not include the MIDI data for song tracks and patterns, audio data, or settings that govern how the musical data is played back, including **Meter**, **Metronome**, **PLAY/MUTE**, and **Track Play Loop** (including Start/End measure).

While loading a Template Song, you can also optionally load one or more Drum Track patterns.

1. Select "Load Template Song" to open the dialog box.

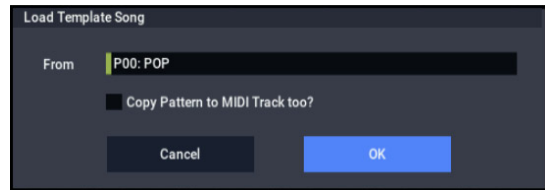

2. In "From," specify the Template Song that you wish to load.
3. If you check "Copy Pattern to MIDI Track too?," the "Copy Pattern To Track" dialog box will appear automatically after "Load Template Song" has been executed.

If you execute without checking this, only the template song you specified in step 2 will be loaded.

4. To load the Template Song, press the OK button. To cancel without loading, press the Cancel button.

When you execute, song settings other than Play Loop and RPPR will be copied.

If in step 3 you checked "Copy Pattern to MIDI Track too?" and pressed the OK button, the "Copy Pattern To MIDI Track" dialog box will appear.

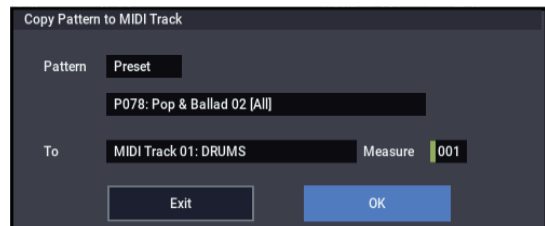

This dialog box is the same as in the page menu command "Copy To MIDI Track".

5. In Pattern, select the pattern that you wish to copy.

In **To Track**, select the copy destination track.

In **Measure**, specify the beginning measure of the copy destination.

Note: In each of the preset Template Songs, track 1 is always assigned to a Drum Program. (In some cases, other tracks may also have Drum Programs.)

Following the names for each of the preset patterns, the musical style and the name of the most suitable Drum Programs are partially displayed. (Refer to the VNL for a complete list of Drum Programs.)

By loading a drum track and the corresponding preset pattern, you can instantly set up a Drum Track to match the Template Song.

6. To execute, press the OK button.

When you execute, **Measure** will count up automatically. You may then copy patterns as well. To exit the command, press the **Exit** button.

For details on how to copy preset patterns to a song along with the preset template song, see "Template Songs" on page 78 of the OG.

Save Template Song

This command saves the program selections, track parameters, effect settings, Arpeggiator settings, and the name and tempo of the current song as a user template song U00–15.

Note that this does not include the MIDI data for song tracks and patterns, audio data, or settings that govern how the musical data is played back, including **Meter**, **Metronome**, **PLAY/MUTE**, **Track Play Loop** (including Start/End measure), and RPPR settings.

1. Select “Save Template Song” to open the dialog box.

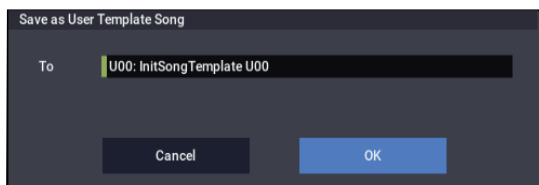

2. In “To,” specify the user template song (U00–15) in which the data will be saved.
3. To save the template song, press the OK button. To cancel, press the Cancel button.

Note that this will over-write the selected template; be careful not to erase data that you’d like to keep!

FF/REW Speed

This allows you to set the speed at which fast-forward or rewind will occur when you press the FF button or REW button.

-  Audio tracks will not produce sound during fast-forward or rewind.

1. Select “FF/REW Speed” to open the dialog box.

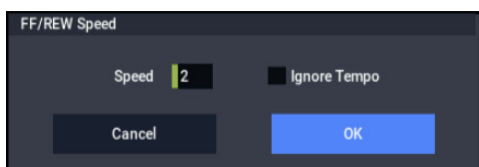

2. In “Speed,” specify the speed (relative to the playback tempo) at which fast-forward and rewind will occur.

This setting is in multiples of the playback tempo. A setting of 1 is the same speed as the playback tempo. Settings of 2–4 respectively correspond to double, triple, or quadruple speed of the playback tempo.

Note: Fast-forward and rewind speeds may be slower in areas where the performance data is dense.

3. If “Ignore Tempo” is checked, the playback tempo and note length will be ignored, and fast-forward and rewind will be performed as fast as possible.

The speed of fast-forward and rewind will differ between sections where the playback data is dense and sections where it is sparse.

If this item is unchecked, fast-forward and rewind will be performed at the speed you specify for “Speed.”

4. To execute the settings, press the OK button. To cancel, press the Cancel button.

Set Location (for Locate Key)

This sets the Sequencer’s locate point. When you press the LOCATE button, the Song will move to the measure, beat, and tick specified here.

1. Select Set Location to open the dialog box.

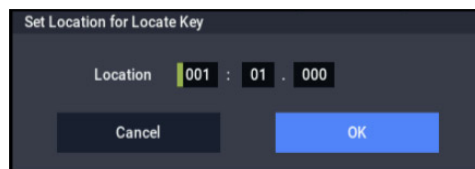

2. Specify the location to which the Song will move when you press the LOCATE button.

From the left, the values are Measure (001–999), Beat (01–16), and Tick (000–479).

If you set this to 001:01.000, pressing LOCATE brings you back to the beginning of the song.

3. To execute the settings, press the OK button. To cancel, press the Cancel button.

Note: When this dialog box is not open, you can hold down the ENTER button and press the LOCATE button to set the current location as the locate point.

GM Initialize

This command transmits a GM System On message to the SEQUENCER mode, resetting all MIDI tracks to the GM settings (See “GM Initialize menu command - Automatically-set parameters and their values” on page 524).

1. Select “GM Initialize” to open the dialog box.

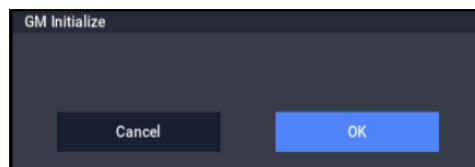

2. To execute the settings, press the OK button. To cancel, press the Cancel button.

-  In SEQUENCER mode, when a GM System On message is received from an external device, or if a GM System On message is recorded in the sequence data, the NAUTILUS will be reset to settings appropriate for GM just as if you had executed this command. However, in these cases, the various MFX/TFX– Master/Total Effect parameters will not be reset.

GM Initialize menu command - Automatically-set parameters and their values

| | Page | Parameter | MIDI Track 1-9, 11-16 | Track 10 | |
|------------------------|----------------------|--------------------------------|-----------------------|----------|--------------------|
| Home | Play/Rec - Mixer | Program Select | G001 | g(d)001 | |
| | | Play/Mute, Solo | - | - | |
| | | Pan | C064 | C064 | |
| | | Volume | 100 | 100 | |
| EQ/X-Y/ Controllers | MIDI Track EQ | Auto Load Prog EQ | On | On | |
| | | Bypass | On | On | |
| | | Input Trim | 99 | 99 | |
| | | High Gain | +00.0 | +00.0 | |
| | | Mid Frequency | 3.20k | 3.20k | |
| | | Mid Gain | +00.0 | +00.0 | |
| | | High Gain | +00.0 | +00.0 | |
| Track Parameters | MIDI | Status | - | - | |
| | | MIDI Channel | - | - | |
| | | Bank Select MSB/LSB | 000 | 000 | |
| | | Timbre Priority | Off | Off | |
| | OSC | Force OSC Mode | - | - | |
| | | OSC Select | - | - | |
| | | Portamento | Off | Off | |
| | Pitch | Transpose | +00 | +00 | |
| | | Detune | +0000 | +0000 | |
| | | Bend Range | PRG | PRG | |
| | | Use Program's Scale | - | - | |
| | Delay | Mode | Time | Time | |
| | | Time | 0000 | 0000 | |
| | Wave Seq/ARP | Wave Sequence Key Sync | PRG | PRG | |
| | | Wave Sequence Swing[%] | PRG | PRG | |
| | | Wave Sequence Quantize Trigger | PRG | PRG | |
| ARP Track On/Off | | Nrm | Nrm | | |
| MIDI Filter/Zones | MIDI Filter | On | On | | |
| | Keyboard Zones | C-1...G9 (Slope=000) | C-1...G9 | | |
| | Vel Zone | 001...127 (Slope=000) | 001...127 | | |
| IFX | MIDI Routing1 | IFX/Indiv.Out Assign | L/R | L/R | |
| | | Send1 | 0 | 0 | |
| | | Send2 | 40 | 40 | |
| | MIDI Routing2 | FX Control Bus | Off | Off | |
| | | REC Bus | Off | Off | |
| | Insert FX | IFX1...12 | | - | |
| | | Pan(CC#8) | | | - |
| | | REC Bus | | | - |
| | | FX Control Bus | | | - |
| | | Send1/2 | | | - |
| Other parameter | | | - | | |
| Common FX LFO | All parameters | | | - | |
| MFX/TFX | Routing | MFX1 | | | Stereo Chorus |
| | | MFX2 | | | Reverb Smooth Hall |
| | | Chain | | | Off |
| | | Chain Direction | | | 1->2 |
| | | Level | | | 127 |
| | | Return1 | | | 127 |
| | | Return2 | | | 50 |
| | Other MFX parameters | | | | - |
| TFX1/2 | | | | - | |
| Master Level | | | | - | |

Copy from Combi

This command copies the parameters of the specified combination to the setting data of the currently selected song.

Note: Only the timbres used by the combination will be copied. Timbres in the combination whose Status is Off will not be copied. If any timbres are set to Mute, the corresponding tracks of the song will be set to a **Status** of Off. However if none of the timbres used in the combination have a MIDI channel setting of Gch, a MIDI track whose MIDI channel is Gch will automatically be specified, and that track will be selected in Track Select. After the copy is executed, you will immediately be able to play in the same state as that combination.

1. Select “Copy from Combi” to open the dialog box.

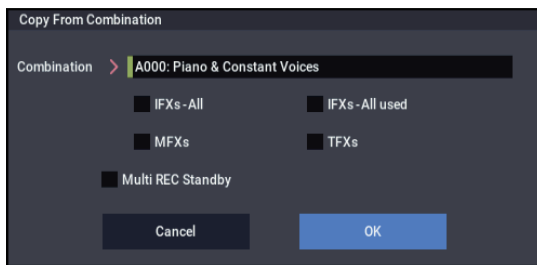

- 2. In “Combination,” select the copy source destination.**
3. Use the IFX-All, IFX-All used, MFXs and TFXs check boxes to specify whether you want the effect settings of the combination to be copied as well.

IFX-All: All insert effect settings of the copy-source combination (the contents of the Insert FX page and the IFX1–12 effect parameters) will be copied.

IFX-All used: Only the insert effects that are used by the copy-source combination will be copied. When copied, they will be packed into unused slots (000: No Effect, unless within a chain).

Note: Copy-source insert effects that are set to 000: No Effect will not be copied. However if 000: No Effect is included within a chain, it will be copied.

If an entire chain in the copy-destination consists of 000: No Effect, it will be used as a copy-destination.

MFXs: All master effect settings of the copy-source combination will be copied.

TFXs: All total effect settings of the copy-source combination will be copied.

4. Specify the desired Multi REC Standby setting.

On: The Status will automatically be set to REC for MIDI tracks corresponding to valid timbres in the copy-source combination. In addition, “Multi REC” (0–1a) will automatically be turned on, and **Recording Setup** (0–5a) will be set to Overwrite.

5. To execute the Copy operation, press the OK button. To cancel, press the Cancel button.

Copy From Program

This command copies settings from the program you specify to the currently selected song.

This is the same function as in COMBINATION mode; for details, see “Copy From Program” on page 433.

This command in SEQUENCER mode differs from its behavior in COMBINATION mode in that the channels assigned to the tracks of the song will be preserved regardless of the “Overwrite ARP/DRUM” setting of the copy-destination track’s “MIDI Channel.” (See step 4.)

Stereo Pair

This lets you assign adjacent audio tracks as a stereo pair. The following parameters of paired channels will be linked with the same values.

Volume, Send1, Send2, EQ (Bypass, Input Trim, Low Gain, Mid Cutoff, Mid Gain, High Gain), Play/Rec/Mute

In addition, you can use the Track Edit page menu commands to edit paired tracks simultaneously.

Paired channels are controlled by the odd-numbered knob or slider. Moving the even-numbered knob or slider will not control the channels.

1. Select Stereo Pair to open the dialog box.

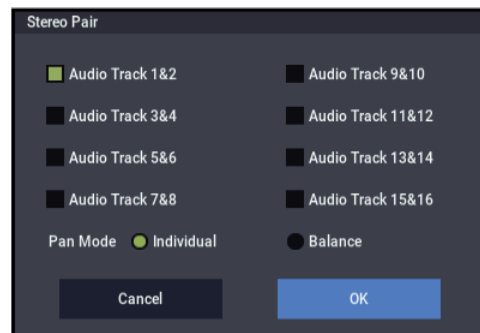

- 2. Use Audio Track 1&2, 3&4, 5&6, 7&8, 9&10, 11&12, 13&14, and 15&16 to specify the audio tracks that you want to pair.**

Uncheck audio tracks that you want to un-pair.

3. Specify the “Pan Mode.”

Individual: The pan of the two channels will operate independently.

Balance: The pan of the two channels will operate as a balance control.

4. To apply the changes you made, press the OK button. If you decide to cancel, press the Cancel button.

Optimize RAM

This command optimizes the RAM memory. When you execute this command, unused memory areas will be reorganized, allowing the full amount of remaining to be used. For more information, see “Optimize RAM” on page 114.

Select Sample No.

This command specifies the sample number into which samples will be written. You can also specify whether the sample will be automatically converted into a program after sampling, and enable **Auto +12dB**.

Note: **Select Sample No.** can be selected if you have chosen RAM for “Save to.”

1. Choose Select Sample No. to open the dialog box.

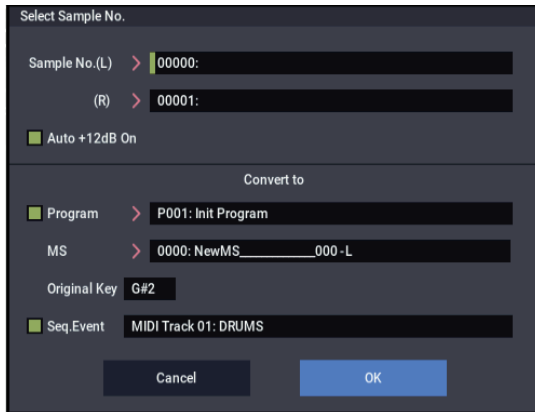

2. In “Sample No.,” choose a sample number where the sampling will be performed.

By default, this will be the lowest-numbered of the vacant sample numbers. If you select ----:---No Assign--- or a sample number that already contains data, the sample will automatically be sampled into the lowest-numbered vacant sample number. If you are sampling in stereo, “Sample No.(L)” and “Sample No.(R)” will be created.

3. Set “Auto +12dB On.”

On (checked): +12dB will automatically be enabled for newly recorded samples. This is the default setting, and if **Recording Level** is set to 0.00 (dB), it means that resampled sounds will play back at the same volume as when they were recorded.

Note that **+12dB** does not change the sample data itself; it only affects the way that the sample is played back.

In general, **+12dB** should be On for drums and loops, and Off for any sounds that you play polyphonically. For more information, see “+12dB” on page 590.

The **Auto +12dB On** setting is made independently for Program, Combination, Sequencer, and SAMPLING modes.

4. “Convert to” lets you specify whether the sample will automatically be converted to a program after sampling. You can also specify whether a note event will be created at the time of sampling.

If the “Program” check box is **checked**, the sample will automatically be converted to a program.

At the right, use “Program” and “MS” to specify the program number and multisample number of the program that will be created.

Original Key (SAMPLING 0–1b) specifies the location of the original key. The multisample will be created with an **Index** (SAMPLING 0–1d) having this key as its **Top Key** (SAMPLING 0–1d). **Original Key** will increment after sampling, so that the next sample will be assigned to the next higher key.

If you **check** the **Seq.Event** check box, a note event will automatically be created in the track specified by **Track**. Note-on will occur at the location at which sampling began, and note-off will occur at the location at which sampling ended. The note event will be created as in **Recording Setup** Overdub mode (i.e., it will be added without erasing existing events). If you are sampling repeatedly without stopping the song playback, the event(s) will be automatically created when you stop song playback. The “Program Select” (0–1b) of the **Track** you created will automatically will automatically change to the program you specified in “Program.”

Seq.Event is available only if “Program” has been checked.

If you sample with **Seq.Event** checked in “Convert to,” the multisample and samples will be the object of the Compare function. If you want re-do sampling, you can select page menu commands **Compare** to return the multisample and samples to the state prior to sampling, and unneeded samples will not remain. The program will not be affected by the Compare operation, and will not return to its prior state.

5. Press the OK button to apply the settings you made, or press the Cancel button to discard any settings you made after accessing the dialog box.

Select Directory/File for Sample to Disk

This command lets you specify the save-destination drive, directory, and filename for the WAVE file that will be created by recording or sampling. It is available when **Save to** is set to Disk.

You can also use the **Select Directory/File for Sample to Disk** dialog to audition WAV files directly from the drive.

For more information, see “Select Directory/File for Sample To Disk” on page 115.

Auto HDR/Sampling Setup

This command walks you through making the appropriate settings for various common operations, including drive recording, audio track bouncing, and sampling/resampling (in-track sampling, etc.). For more information, see “Auto HDR/Sampling Setup” on page 527 of the Parameter Guide.

When you execute this operation, the relevant parameters will be set automatically. You cannot use the page menu command “Compare” to revert to the prior settings.

The settings are automatically made for the most typical applications. After executing the auto setup operation, you can further adjust any of the parameters as described in the paragraphs for each item.

1. Select **Auto HDR/Sampling Setup** to open the dialog box.

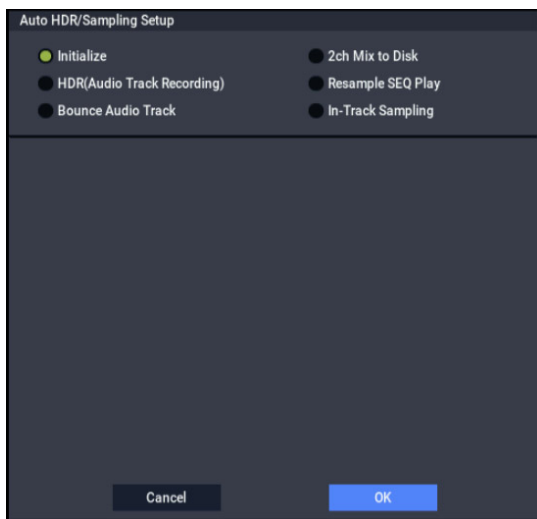

2. Use the radio buttons to select the type of settings you want to make.

Initialize: Set parameters related to drive recording and sampling to their default values.

HDR (Audio Track Recording): Makes the necessary settings for recording external audio signals such as guitar or vocal from the audio inputs to audio tracks.

Bounce Audio Track: Makes the necessary settings for bounce-recording audio tracks.

2ch Mix to Disk: Makes settings for resampling a completed song in order to create a two-channel stereo WAVE file on the drive.

Resample SEQ Play: Makes settings so that you can resample your keyboard playing in SEQUENCER mode.

In-Track Sampling: Makes settings to sample only an external audio signal using the In-Track Sampling function.

3. The settings for the rest of the procedure will depend on what you selected in step 2. (For details, refer to the explanations below.)

Initialize

1. Refer to **Auto HDR/Sampling Setup** steps 1 and 2, and select **Initialize**.
2. Press the **OK** button to execute the command. If you decide not to execute, press the **Cancel** button.

For more information, see “Auto HDR/Sampling Setup: Automatically-set parameters and their values” on page 531.

HDR (Audio Track Recording)

1. Refer to **Auto HDR/Sampling Setup** steps 1 and 2, and select **HDR (Audio Track Recording)**.
2. Press the **OK** button to open the dialog box.

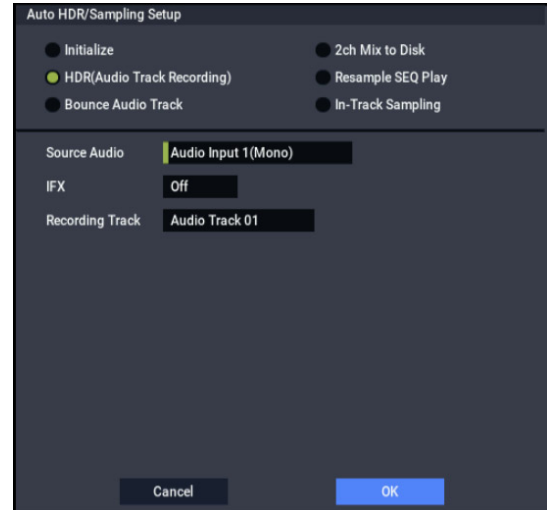

3. In “Source Audio,” select the external audio input source.

If the external audio input source is monaural:

Audio Input1 (Mono), 2 (Mono): Selects the analog audio signal from a mic, musical instrument or other device connected to the analog audio inputs.

USB 1(Mono), 2(Mono): Selects the digital audio signal from a computer connected via USB.

If the external audio input source is stereo:

Audio Input1/2(Stereo): Selects the stereo analog audio signal from a musical instrument or other device connected to the analog audio inputs.

USB 1/2(Stereo): Selects the digital audio signal from a computer connected via USB.

4. Specify whether you want to apply an insert effect to the input source (i.e., to record the processed signal). Choose the insert effect you want to use. If you don’t want to use an effect, turn this Off.)

Note: If you’re using more than one insert effect, make settings for the Insert FX page **Chain** parameters after you execute **Auto HDR/Sampling Setup**. For the last insert effect in the chain, set the **REC Bus** to 1 (for a mono source) or 1/2 (for a stereo source). (At this time, you will normally set **Bus Select** to **Off**—but you don’t have to do so.)

Note: You can also record the input source to an audio track without applying an insert effect, and then send the output of the audio track through an insert effect. Make the appropriate **Bus Select** setting in the IFX– Audio Routing 1 page for the audio track you recorded.

5. Use “Recording Track” to specify the track(s) that will be recorded.

If “Source Audio” is set to Audio Input 1 (Mono) or 2 (Mono), or R (Mono), or USB 1 (Mono) or 2 (Mono), choose from Audio Track 1–16.

If “Source Audio” is set to Audio Input 1/2 (Stereo), or USB 1/2 (Stereo), choose from Audio Tracks 1&2–15&16. When you execute the command, the “Stereo Pair” setting will be made automatically so that you can record in stereo.

6. Press the OK button to execute the command. If you decide not to execute, press the Cancel button.

For more information, see “Auto HDR/Sampling Setup: Automatically-set parameters and their values” on page 531.

Recording to the audio track(s) after executing the command

1. Connect your instrument etc. to the AUDIO INPUT jack you selected in “Source Audio,” and use “Audio Track Recording Level” to adjust the recording level.
2. Set “Location” to the location that you want to record.
3. Press the SEQUENCER REC button and then the SEQUENCER START/STOP button. (Recording will begin.)
4. Play the musical instrument etc. that is connected to the AUDIO INPUT jack(s) you selected for “Source Audio.”
5. When you have finished performing, press the SEQUENCER START/STOP button. (Recording will stop.)

Check the audio track(s) that you recorded

- To listen to the audio track you recorded, press the SEQUENCER START/STOP button to play back the track.

Bounce Audio Track

1. Refer to Auto HDR/Sampling Setup steps 1 and 2, and select Bounce Audio Track.
2. Press the OK button to open the dialog box.



3. Use “Mode” to specify whether you will bounce in mono or in stereo.

Mono: Tracks will be bounced to a single audio track. Any stereo information will not be maintained.

Stereo: Tracks will be bounced in stereo to two audio tracks.
4. Use “From” to select the source tracks for the bounce.

If **Mode** is set to Mono, you can bounce up to 15 tracks; if it’s set to Stereo, you can bounce up to 14 tracks.

5. Use “To” to select the record track(s).

If **Mode** is set to Mono, choose from Audio Track 1–16.

If **Mode** is set to Stereo, choose from Audio Track 1&2–15&16.

6. Press the OK button to set up the tracks for the bounce.

You can also exit without making any changes, by pressing the Cancel button.

For more information, see “Auto HDR/Sampling Setup: Automatically-set parameters and their values” on page 531.

After completing the steps above, the tracks are set up, and you’re ready to record the bounce.

7. Press the SEQUENCER REC button and then the SEQUENCER START/STOP button.

Only the audio track(s) you selected in “From” will play back, and the bounce recording will begin.

8. When the audio track(s) finish playing back, press the SEQUENCER START/STOP button.

This completes the bounce. Next, check the recorded results:

9. Turn on SOLO for newly recorded audio track.
10. Press the SEQUENCER START/STOP button to begin playback.

Effects are not recorded when bouncing tracks directly

If you don’t change the settings after executing the command, the effect settings will be ignored, and the audio from the audio track will be bounced directly. Even if IFX1 is being applied to the output of Audio Track 1 and 2 as shown below, IFX1 will not be applied to the sound that is recorded on the bounce-destination audio tracks.

Audio Track 01: Guitar 1 → IFX1: Guitar Amp
 Audio Track 02: Guitar 2 → IFX1: Guitar Amp
 Audio Track 03= Audio Track 01 + Audio Track 02

If you want to apply an effect to the output of audio track 03, use the audio track 03 **Bus Select** parameter to send the output to IFX1.

An example of changing the settings

- If you want to bounce audio that is processed by an effect, you can do this by changing the **REC Bus** or **REC Source** settings.

If you want to bounce the audio from the audio track after it has been processed by the insert effect and master/total effects, send the post-effect audio to the REC Bus, and set the bounce-destination audio track’s **REC Source** to REC Bus.

Audio Track 01 → IFX1 → **REC Bus** 1

Audio Track 02 → IFX1 → **REC Bus** 1

Audio Track 03: **REC Source** REC 1

When you bounce, the audio processed by IFX1 will be recorded on audio track 03.

- If you want to bounce audio after it is processed by a total effect, set the bounce-destination audio track’s **REC Source** to L/R, and make settings so that the post-effect sound is sent to the bounce-destination audio track.

Audio Track 01 → Solo On → IFX1 → MFX/TFX

Audio Track 02 → Solo On → IFX1 → MFX/TFX

Audio Track 03: **REC Source** L

When you bounce, the audio processed by IFX1 and MFX/TFX will be recorded on audio track 03.

2ch MIX to Disk

1. Refer to Auto HDR/Sampling Setup steps 1 and 2, and select 2ch MIX to Disk.
2. Press the OK button to execute the command. If you decide not to execute, press the Cancel button.

For more information, see “Auto HDR/Sampling Setup: Automatically-set parameters and their values” on page 531.

Making the song into a two-channel (stereo) WAVE file after you execute this command

1. Select the song that you want to resample.
2. Press the SAMPLING REC button and then the START/STOP button (Standby).
3. Press the SEQUENCER START/STOP button.
The song will play back, and resampling will begin at the same moment.
4. When song playback ends, resampling will stop, and a WAVE file will be created.

You can also finish the resampling at any time by pressing the SEQUENCER START/STOP button during playback.

Note: Use the **Select Directory/File for Sample to Disk** menu command to specify the location in which the new WAVE file will be created.

Resample SEQ Play

1. Refer to Auto HDR/Sampling Setup steps 1 and 2, and select Resample SEQ Play.

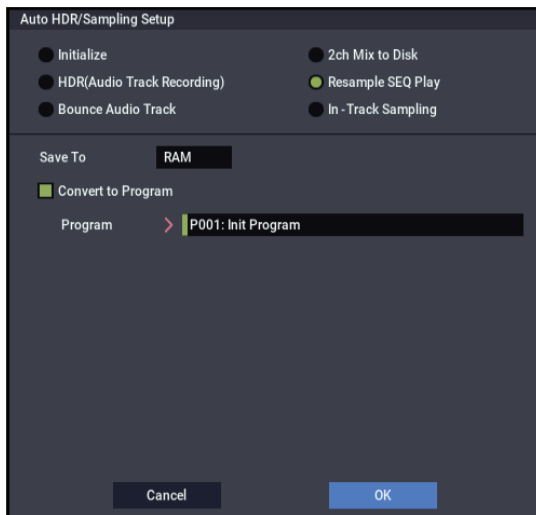

2. Use “Save to” to select either RAM or DISK as the destination to which the resampled data will be written.

If you select RAM, the data will be written into SAMPLING mode. If you select the DISK setting, a WAVE file will be created from the sampled data and saved to the drive.

3. If you selected “Save to” RAM, you can specify whether the data will be automatically converted to a program after resampling.

If you want the data to be converted, check “Convert to Program” and use the “Program” field to specify the convert-destination program.

4. Press the OK button to execute the command. If you decide not to execute, press the Cancel button.

For more information, see “Auto HDR/Sampling Setup: Automatically-set parameters and their values” on page 531.

Resampling after you execute this command

1. Press the SAMPLING REC button and then the SAMPLING START/STOP button, and then play the keyboard etc.

Since “Trigger” (0–8c) is set to Note On, sampling will begin at the first note-on.

2. When you’ve finished playing, press the SAMPLING START/STOP button to stop resampling.

Note: If you execute Resample SEQ Play with “Save to” RAM and “Convert to Program” checked, you can continue sampling without changing the settings, and the samples will automatically be assigned to C#2, D2, ... and so on. A new multisample will be created when you execute “Resample SEQ Play” once again and sample.

Auditioning the new sample

- If you executed with “Save to” RAM and “Convert to Program” checked, select the program you specified as the convert-destination, and play the C2 key to hear the result.

If you didn’t check “Convert to Program,” use SAMPLING mode to select and audition the sample.

- If you executed with “Save to” DISK, use the page menu command **Select Directory/File for Sample to Disk** to audition the sample.

Note: To change the sample number used for sampling (when using “Save to” RAM), use the page menu command **Select Sample No.** If you want to change the save-destination for the WAVE file (when using “Save to” DISK), use the menu command **Select Directory/File for Sample to Disk.**

An example of changing the settings

- To change the way in which sampling is initiated, change the “Trigger” setting.
- If you want to simultaneously sample an external audio source from AUDIO INPUT etc. together with your own playing on a program, set the Sampling page Input 1–2 and USB **Bus(IFX/Indiv.) Select** setting to L/R, and the **Source Bus** to L/R.

If you selected In-Track Sampling:

1. Refer to Auto HDR/Sampling Setup steps 1 and 2, and select In-Track Sampling.

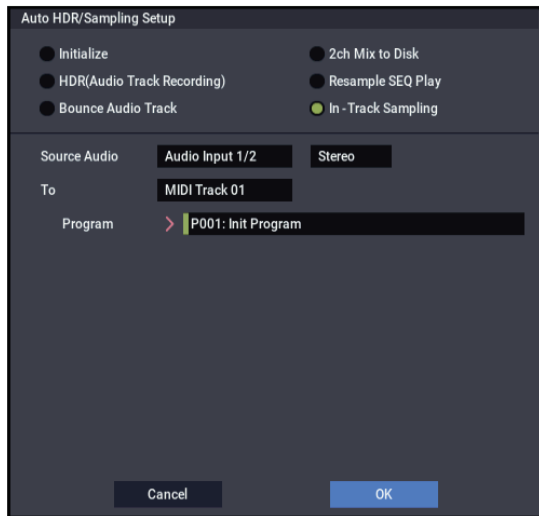

2. Use “Source Audio” to select the external audio input source: analog Audio Input 1/2 or USB.
3. Use “Mono-L/Mono-R/Stereo” to select the input source and the number of channels you will sample.
Mono-L uses Analog 1 or USB 1.
Mono-R uses Analog 2 or USB 2.
Stereo uses both channels from the given input.
4. Use the “To” field to select the track that you will use for In-Track Sampling.
Note data will automatically be written to the track you select.
5. Use “Program” to specify the program into which the sample will be converted.
When sampling ends, the entire process of creating a new multisample through converting it to a program and assigning it to a track will be performed automatically.
6. Press the OK button to execute the command. If you decide not to execute, press the Cancel button.
For more information, see “Auto HDR/Sampling Setup: Automatically-set parameters and their values” on page 531.

In-Track Sampling after you execute this command

1. Use “Location” to specify the location from which you want the song to play back.
2. Press the SAMPLING REC button to enter sampling-standby mode.
3. Press the SEQUENCER START/STOP button to begin playback.
4. At the point where you want to start sampling, press the SAMPLING START/STOP button. In-Track Sampling will begin.
5. Play the instrument etc. that is connected to the AUDIO INPUT jack you selected as the “Source Audio” setting.
6. When you’re finished playing, press the SAMPLING START/STOP button to stop only sampling.
If you press the SEQUENCER START/STOP button, both sampling and song playback will stop.

Note: If you continue sampling after executing In-Track Sampling, successive samples will automatically be assigned to C#2, D2, ... etc. However if you execute Auto Sampling Setup once again and then sample, the samples will be created in a new multisample.

Auditioning the data you sampled

- Return the “Location,” and then press the SEQUENCER START/STOP button to play back the song.
Alternatively, use **Track Select** (0–1a) to select the track you specified in “To” (dialog box), and play the C2 key.

An example of changing the settings

- If you want to apply an insert effect to the input source, go to the SEQUENCER > Home– Sampling page and set Audio Input **Bus Select** to IFX1–IFX12. Set the **Bus Select** following the insert effect you’re using to REC 1/2.
- To change the way in which sampling is initiated, change the “Trigger” setting. If you set this to Threshold, resampling will begin the instant the input level exceeds the specified value.
Use the page menu command **Select Sample No.** to select the sampling-destination RAM memory.

Auto HDR/Sampling Setup: Automatically-set parameters and their values

| | | Initialize | HDR (Audio Track Recording) | Bounce Audio Track | 2ch Mix to Disk | Resample SEQ Play | In-Track Sampling |
|------------------------|-----------------------|------------------------|-----------------------------|------------------------|------------------------|------------------------|------------------------|
| Input (Input Source)*1 | | Input 1 & 2, USB 1 & 2 | [Source Audio]*2 | Input 1 & 2, USB 1 & 2 | Input 1 & 2, USB 1 & 2 | Input 1 & 2, USB 1 & 2 | [Source Audio]*2 |
| Input 1&2, USB 1&2*6 | Bus Select | Off | [IFX] | Off | | | |
| | FX Ctrl Bus | Off | | | | | |
| | REC Bus | Off | | | | | 1/2 |
| | Send1/2 | 000 | | | | | |
| | Level | 127 | | | | | |
| Input 1, USB 1 | Pan | L000 | | | | | |
| Input 2, USB 2 | Pan | R127 | | | | | |
| Audio Track | Play/Rec/Mute | Play | [Recording Track]: REC *8 | [To][Mode]: REC *8 | - | - | - |
| | Solo | - | - | [From]: Solo On | - | - | - |
| | REC Source | In1 | [Source Audio][IFX]*6 | REC 1/2 *8 | - | - | - |
| | Stereo Pair | Off | [Source Audio]*6 | [Mode] *8 | - | - | - |
| Sampling Setup (Name) | Source Bus | L/R | - | - | L/R | L/R | REC1/2 |
| | Source Direct Solo | (N/A) | - | - | (N/A) | (N/A) | Off |
| | Trigger | Note On | - | - | Sequencer START button | Note On | Sampling START button |
| | Metronome Precount | (N/A) | - | - | (N/A) | (N/A) | - |
| | Save to | RAM | - | - | DISK | [Save to] | [Save to] |
| | Mode | Stereo | - | - | Stereo | Stereo | [Source Audio]*3 |
| | Sample Time(RAM) | Maximum | - | - | (N/A) | - | - |
| | Sample Time(DISK) | 80min | - | - | - | - | - |
| | Rec Level | +0.0 | - | - | +0.0 | +0.0 | +0.0 |
| Select Sample | Auto +12dB On | On | - | - | - | On*4 | On*4 |
| | Convert to Program | Off | - | - | - | [Convert to Program]*5 | [Convert to Program]*5 |
| | Program | - | - | - | - | [Program]*5 | [Program]*5 |
| | MS | - | - | - | - | (Newly created)*5 | (Newly created)*5 |
| | Original Key | - | - | - | - | (C2)*5 | (C2)*5 |
| | Seq. Event | - | - | - | - | - | On*5 |
| | MIDI Track | - | - | - | - | - | [To]*5 |
| Select Directory | - | - | - | - | - | - | |
| Insert FX | Bus Select (Post IFX) | - | REC1/2(st), REC1(mn)*7 | - | - | - | - |

-: Not set automatically

[]: Set automatically according to the parameter settings in the dialog box

*1 [] User Global Setting: Edit Song Parameters

[x] User Global Setting: Edit GLOBAL Parameters

*2 The input source specified as Source Audio will be set.

*3 L-Mono if the Source Audio is Mono-L, R-Mono if it is Mono-R, and Stereo if it is Stereo

*4 When Save to=RAM

- *5 When Save to=RAM, when Convert to Program=On
- *6 If IFX=Off, set to [Source Audio]. If Stereo, turn Stereo Pair off.
If IFX=IFX1...12, set to REC1/2 (Stereo) or REC1 (Mono).
- *7 If IFX=IFX1...12, specify the Bus Select of that IFX1...12. If effects are chained, specify the last IFX in the chain.
- *8 If the source audio Mode=Stereo, Multi REC is turned On, and a stereo pair is set to REC as the To track, set the From Track "REC Bus" to REC1/2.

Bounce All Tracks To Disk

This command bounce-records all tracks in the song to a single WAVE file (stereo).

Simply use the dialog box to specify the bounce-recording destination song and the name of the file that will be created, and press the OK button. The WAVE file will be created automatically.

1. Use "Song Select" to select the song you want to bounce.
2. Select "Bounce All Tracks To Disk" to open the dialog box.

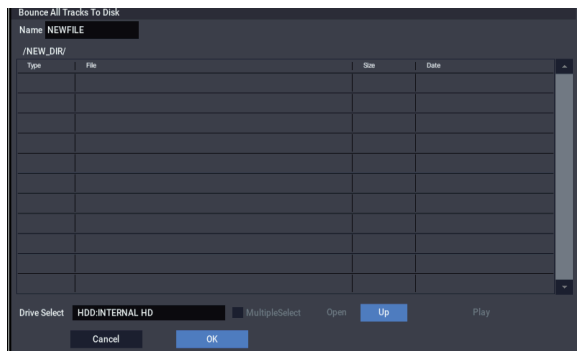

3. Use "Drive Select," "Open," and "Up" to select the directory in which the WAVE file will be saved.
4. Use "Name" to specify the filename of the WAVE file that will be created by bounce-recording.
5. Press the OK button to execute the command. If you decide to cancel, press the Cancel button.
The bounce-source song will start playing, and recording will begin simultaneously. When song playback ends, bounce-recording will end.

Copy Tone Adjust

For more information, see "Copy Tone Adjust" on page 118.

Reset Tone Adjust

For more information, see "Reset Tone Adjust" on page 119.

Show EQ Graphic

This calls up a floating window, showing a graphic representation of the selected Track's EQ settings. You can leave the window open as you work; as you change EQ settings, or select different Tracks, the graphic will update accordingly.

The window will cover the parameters for some of the Tracks on either the right or left sides of the display. If you select one of these Tracks, the window will automatically move to the other side of the display.

Copy X-Y Envelope

For more information, see "Copy X-Y Envelope" on page 119.

Detune BPM Adjust

This command is available on the Pitch tab of the Track Parameters page. This command can be used only when the **Detune** parameter is currently selected; otherwise, the menu selection will be grayed out.

Detune BPM Adjust changes the tempo of all loops within a Program by changing the Track's **Detune** parameter. The sample data itself is not altered. Since this alters the pitch of the loop along with the tempo, it's generally suited only to un-pitched percussive loops.

For more information, see "Detune BPM Adjust" on page 437.

MIDI Step Recording

Step recording allows you to specify the length and velocity of each note numerically, and to input MIDI data, the pitches, from the keyboard. You can also use the on-screen buttons to enter Rests or Ties.

- 🔗 If you use step recording to input data into a track that already contains sequence data, all data will be erased from the **From Measure** and subsequent measures. If after recording, you decide to revert to the prior data, use the Compare function.

To input data with a continuously-changing value such as pitch bend, it is best to use the "Create Control Data" menu command. To input individual data events such as program changes, use the "MIDI Event Edit" menu command.

1. Use Track Select to select the track into which you wish to input data, and use From Measure (4-1b) to specify the measure at which you wish to begin input.
2. When you select "MIDI Step Recording," the following dialog box will appear.

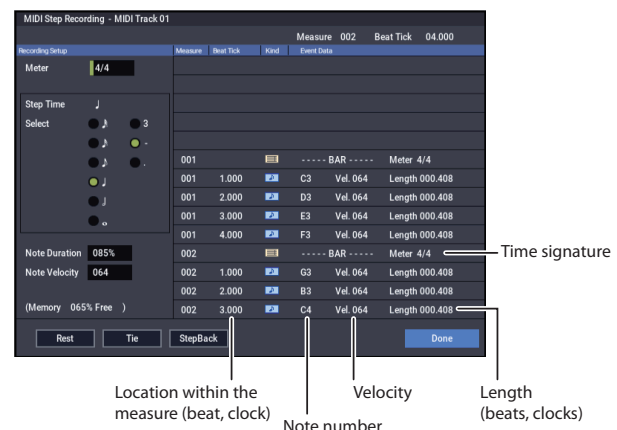

3. In Meter, set the time signature.

This will show the time signature that has already been set for the measure.



















If you change the time signature setting, the time signature data of the measures you record will change, and all tracks will change to the time signature you specified.

4. In “Step Time,” specify the length (in terms of a note value) of the basic interval at which you will input data.

From the popup menu at the left, select the note length from between ♩ (whole note) and ♪ (32nd note).

If you want the selected note value to be a dotted note or a triplet, use the popup menu at the right to select a dot “. (Dot)” or triplet “3 (Triplet).” To use the unmodified value of the selected note, choose “– (Normal).”

The following table shows the number of clocks represented by each “Step Time” selection.

| | | | | | |
|---|---|---|---|---|---|
|  |  |  |  |  |  |
| (0:060) | (0:120) | (0:240) | (1:000) | (2:000) | (4:000) |
|  |  |  |  |  |  |
| (0:090) | (0:180) | (0:360) | (1:240) | (3:000) | (6:000) |
|  |  |  |  |  |  |
| (0:040) | (0:080) | (0:160) | (0:320) | (1:160) | (2:320) |

5. In “Note Duration,” specify the length that the note will actually be held, relative to the “Step Time.”

In general, 100% will be tenuto, 85% will be normal, and 50% will be staccato.

6. Use “Note Velocity” to specify the velocity value (keyboard playing strength) of the note data.

If you set this to Key, the actual velocity at which you played the key will be input.

7. Input the note events described below by playing notes on the keyboard or by pressing the buttons in the lower part of the dialog box.

- Entering notes

When you press a key on the keyboard, that note number will be input as a note of the length specified in step 4.

When you press a chord on the keyboard, those note numbers will be input as chords of the length specified in step 4. Since each of the note numbers you press before releasing all of the keys will be input at the same location, the notes will be input as a chord even if they are actually played at different times.

Each time you press and release the keyboard, the location will advance by the length specified in step 4.

- Entering rests

Press the Rest button to enter a rest of the length specified in step 4.

- Entering a tie

If you press the Tie button without pressing the keyboard, the previously-input note will be tied, and lengthened by the amount specified in step 4.

If you press the Tie button while holding down a note, the note you are playing will be tied, and lengthened by the amount specified in step 4.

You can even enter notes as shown in the following diagram.

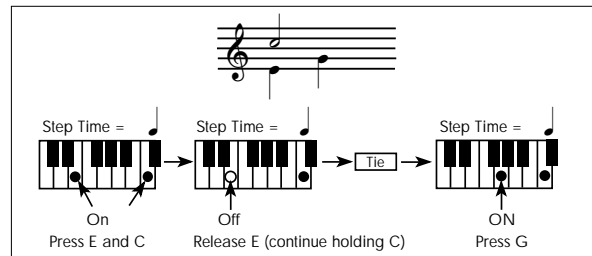

- Deleting a note or rest

To delete a note or rest, press the Step Back button. The location will move backward by the amount specified in step 4, and the data in that interval will be deleted.

8. When you are finished with step recording, press the Done button.

If you select the page menu command “Compare”, you will return to the condition of before you began step recording.

MIDI Event Edit

Here you can edit individual events of MIDI data that were input.

1. Use **Track Select** to select the track that you wish to edit
2. Use the **From Measure (4–1b)** field to specify the measure at which you wish to begin editing.
3. Select the **MIDI Event Edit** menu command.

If **Track Select** is set to MIDI Track01–16, the Set Event Filters dialog box will appear.

If **Track Select** is set to the Master Track, the Event Edit window will appear immediately; Set Event Filters will not appear.

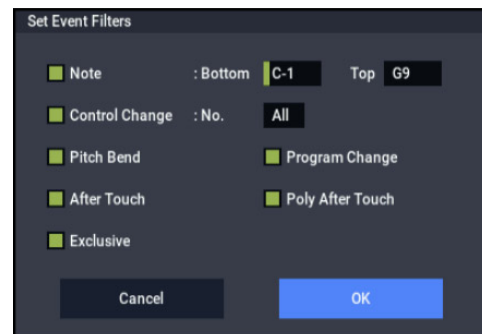

Set Event Filters lets you choose which types of MIDI data will appear in the event edit window. You can use this to focus on one or more specific types of data, or to hide data that you’re not interested in at the moment. Only the data which is shown can be edited.

You can choose to view only a specific range of notes, by setting the **Note Bottom** and **Top** as desired. To edit these settings, you can use the standard shortcut: hold ENTER and play a note on the keyboard. Normally, leave these set at the defaults of C–1 and G9.

Control Change lets you show only a specific control change number, or ALL controllers (the default).

You can also show or hide **Pitch Bend**, **Program Change**, **After Touch**, **Poly After Touch**, and **Exclusive**.

4. Press the **OK** button to open the Event Edit dialog box.

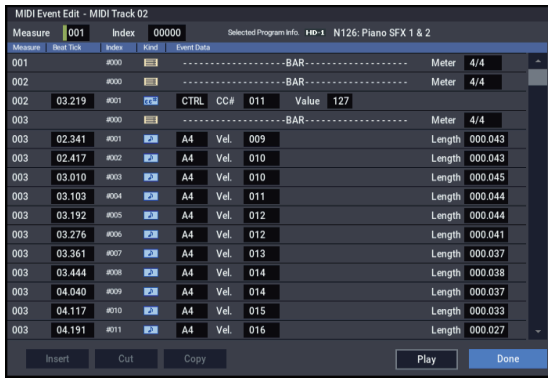

5. In the upper part of the dialog box, Measure and Index show the measure that you are editing and the events of the index numbers within the measure.

You can touch the scroll bar located at the right to move to the event that you wish to edit.

6. Select the event that you wish to edit, and use the VALUE controller etc. to modify its value(s).

By modifying the value of the “Beat Tick” location within the measure, you can move the event within the measure.

You can edit each event by modifying its data value(s). When you select a note event, it will sound.

7. You can press the buttons located at the bottom of the dialog box to edit events as follows.

- Inserting an event
Select the location “Beat Tick” at which you wish to insert an event, and press the Insert button to insert an event.
- Deleting an event
Select the event that you wish to delete, and press the Cut button to delete the event.
- Moving an event
You can use the Cut button and Insert button to move an event (by “cut and paste”).
Use the Cut button to delete the event that you wish to move, then use the Insert button to insert it at the desired location.
You can also move an event by modifying its “Beat Tick” value.
- Copying an event
Select the event that you wish to copy, and press the Copy button. Then select the copy destination and press the Insert button to insert the event at that location.
- Playing back an event
When you press the Play button, a dialog box will open and the song will begin playing. Use this to audition the edits you’ve made in Event Edit.

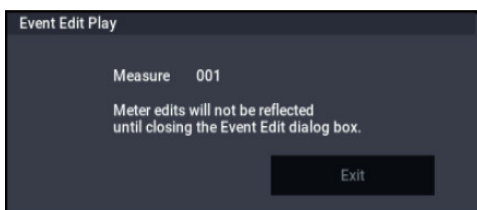

Playback will start from the beginning of the measure that includes the selected event. If there is no selected event,

playback will start from the **Measure** setting of the song—just like playback on the Home– Mixer page.

If you want to hear only the track you’re editing, stop the Event Edit to solo the track, or to mute other tracks.

Playback will begin from the measure specified by **Measure**.

If you’ve edited the **Meter**, the change will not be reflected in the playback until you exit Event Edit.

When you press the Exit button, playback will stop and you will return to the Event Edit dialog box.

8. When you are finished event editing, press the Done button.

If you select the page menu command “Compare”, you will return the data to the condition in which it was before you began event editing.

The following table shows the types of musical data that can be edited by “MIDI Event Edit” and the range of their values.

| BAR (displayed only) (Measure line) | | Meter: 1/4...16/16 *1 (Time signature) |
|--|--|--|
| C-1...G9 *2 (Note data) | V: 1...127 *2 (Velocity) | L: 000.000...15984.000 (Length: beats, clocks) |
| PAFT (Polyphonic after touch) | C-1...G9 (Note number) | 0...127 (Value) |
| CTRL (Control change) | C: 0...119 (Control change number) | 0...127 (Value) |
| PROG (Program change) | Bank: A...T 000...127 G, g(1)...g(9) g(d) --- | P: 0...127 P: 1...128 (when G, g(1)...g(d)) P: 0...127 (Program number) |
| AFTT (After Touch) | 0...127 (value) | |
| BEND (Pitch bend) | -8192...+8191 (value) | |
| EXCL *3 (Exclusive) | | |

*1: Be aware that because the time signature is recorded in the master track, modifying it from any track will affect the same measure of all tracks, causing them all to be played in the modified time signature.

Note: *2: Note data and velocity values can also be entered by holding down the ENTER button and playing a note on the keyboard.

*3: You cannot change System Exclusive events into a different type of event (e.g., a Note or Control Change event). Nor can you change any other type of event into a System Exclusive event.

Pattern numbers will be displayed in locations in which a pattern has been “put” (placed). At the end of the track there will be an indication of End of Track.

Audio Event Edit

This command lets you edit individual audio events that have been recorded, or trim (i.e., make adjustments in steps of a single sample to) the region used by audio events.

If you want to change the name of a region after recording, use the Select Region dialog box.

Note: As long as there is data in the master track, you can open the audio event editing dialog box even if the audio track is empty.

1. Use **Track Select** to select the audio track you want to edit, and use **From Measure (4-1b)** to select the measure at which you want to begin editing.
2. Choose the **“Audio Event Edit”** command to open the dialog box.



3. **Measure and Index** located in the top line of the dialog box show the measure for editing and the index number of an event within that measure; this event is shown at the top of the list of events.

You can use the scroll bar at right to move to the event you want to edit.

You can select an audio event and press the Play button to hear that event. This is a convenient way to audition your changes.

4. Select the event you want to edit, and use the **VALUE controller** to input the desired values.
- You can edit the Location **Measure** and **“Beat Tick”** to move the location of the event. However, you can't place two or more events at the same location.

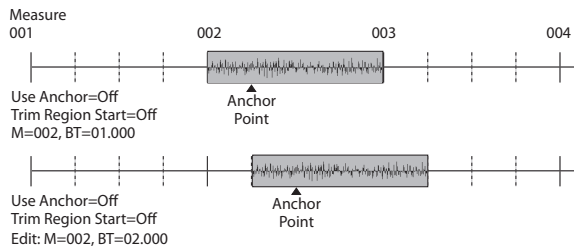

- If you check the **“Anchor”** check box, the anchor point location will be displayed in **Measure** and **“Beat Tick”**, and you can specify the location using this anchor point as the reference. This is convenient when a point inside a region needs to be aligned at a specific location.

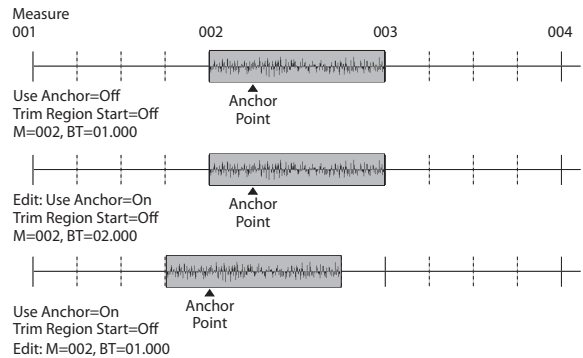

- If you edit the location with **“Trim Region Start”** checked, the **“Start”** of the region will also be adjusted simultaneously. Check this box if you want to adjust the length without changing the overall position.

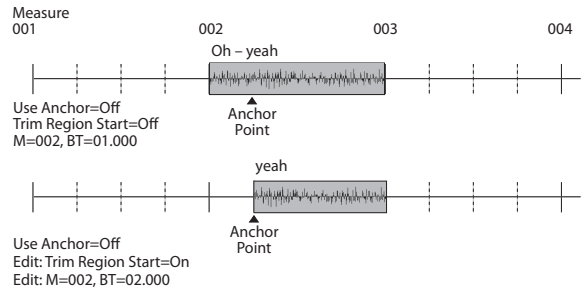

- **“V”** (Volume) specifies the volume of the audio event.
Note: The volume of an audio track is determined by this volume value multiplied by the volume of the audio track.
 - You can edit the end location **“E”** (Measure. Beat. Tick) to change the location at which the event ends. Editing the end location will change the **“End”** of the region. However, you can't set this to a point beyond the length of the WAVE file.
5. Press the **Select Region** button to change the region.

When you press the **Select Region** button, the **Select Region** dialog box will appear.



The procedure is the same as for **“Region Edit.”** The region will be changed when you press the **OK** button. If

you press the Cancel button, the region will not be changed.

If stereo pairing is enabled and you're editing a stereo audio event, the dialog box will appear twice. In the second dialog box, select the region for the other paired track.

6. Use the buttons located at the bottom of the dialog box to edit the event.

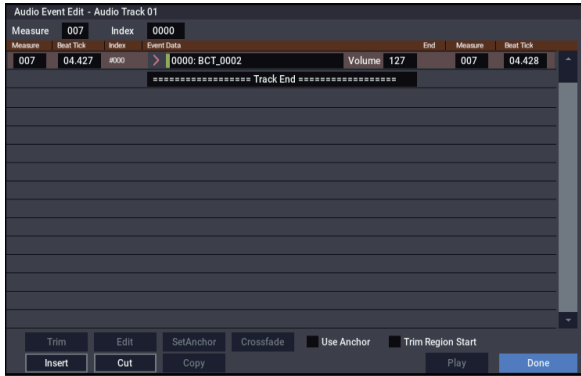

Inserting an event

Select the event that follows the location at which you want to insert, and press the Insert button. If you press the Insert button without having previously used the Copy button or Cut button to load audio event data into the copy buffer, only the first Select Region dialog box will appear; select the region that you want to insert as described in step 5, and then press the OK button. Press the Cancel button if you decide not to insert. (See

Deleting an event

Select the event that you wish to delete, and press the Cut button to delete the event.

Moving an event

You can use the Cut button and Insert button to move an event (by "cut and paste").

Use the Cut button to delete the event that you wish to move, then use the Insert button to insert it at the desired location.

Copying an event

Select the event that you wish to copy, and press the Copy button. Then select the copy destination and press the Insert button to insert the event at that location.

7. "TRIM": This edits the area in which the region will sound.

Select the region that you want to edit, and press the Trim button to open the Trim dialog box.

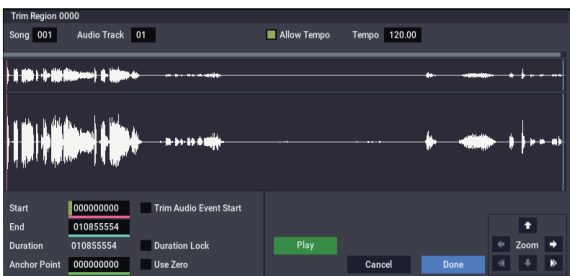

The functions and operation are the same as in the trim dialog box of "Region Edit," with the exception of "Trim Audio Event Start." (See "Region Edit" on page 547.)

If you check "Trim Audio Event Start," editing the "Start" value will simultaneously modify the location (Measure and "Beat Tick") of the audio event. Check this option if you want to adjust the length without changing the position at which the entire event will sound. This will operate in the same way as if "Trim Region Start" is checked in step 4.

The region will be modified when you press the Done button. If you press the Cancel button, the region will not be modified.

8. "Set Anchor": This sets the anchor point at the beginning of the first measure from where the audio event is placed.

Select the event that uses the region in which you want to specify an anchor point, and press the Set Anchor button. For more about how to use anchor points, refer to step 4.

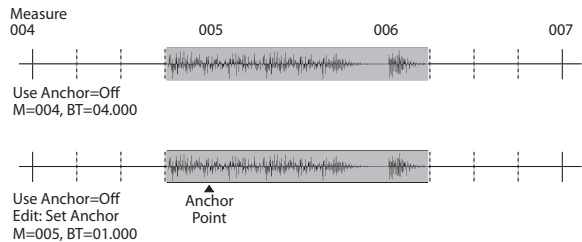

Note: If you want to edit the anchor point that is automatically set here, use TRIM to make adjustments in units of samples.

Tip: For example, you can specify the anchor point as the starting location of a region. Then you can turn on "Use Anchor," and easily place that phrase at the beginning of another measure.

9. Edit the waveform data of the WAVE file assigned to the region.

Select an event that uses the region you want to edit, and press the Edit button to open the edit dialog box.

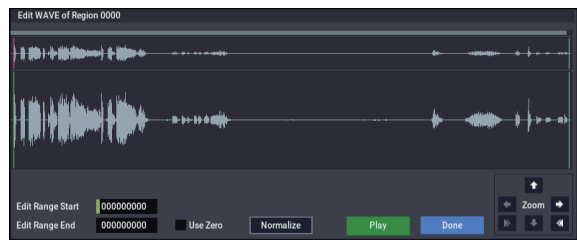

WAVE file waveform display, ZOOM

This area displays the waveform of the WAV file assigned to the region. the waveform display and ZOOM buttons operate in the same way as in SAMPLING mode, except that the displayed data is a WAVE file. Refer to the SAMPLING mode sections "1-1c: Sample waveform display" on page 586 and "1-1f: ZOOM" on page 587.

Edit Range Start [00000000...230399998]

Edit Range End [00000001...230399999]

"Edit Range Start" and "Edit Range End" set the range of the waveform that will be edited.

This range is highlighted in the "WAVE file display." To audition the selected region, press the PLAY or SAMPLING START/STOP buttons.

Use Zero [Off, On]

On (checked): When you set "Edit Range Start" or "Edit Range End," you will only be able to select zero-cross points; i.e., addresses at which the waveform level is at

the center “zero” line. Use the VALUE dial, or +/- buttons to move to the previous or next zero-cross address. If you use the numeric keypad to enter a value directly, you will move to the zero-cross point that is nearest that value.

Off (unchecked): You can adjust the “Edit Range Start” and “Edit Range End” address in units of 1. This is the normal mode of operation.

Normalize

This command processes a WAVE file in the same way as the “Normalize/Level Adj.” menu command in SAMPLING mode. For more information, see “Normalize/Level Adjust” on page 617.

The “Normalize” command applies a uniform change to the sample levels between “Edit Range Start” and “Edit Range End.” It boosts the level of the sample data in the specified range as much as possible without causing it to clip. If the data was sampled at a low level, you can use this command to increase the dynamic range of the sample data. You can use **Level** to raise or lower the level as necessary.

10. “Crossfade”: This creates an event in which the volume is gradually modified in the area where two audio events overlap, causing them to be mixed.

Edit the location and end location so that the two events overlap. Then select the first of the two events, and press the Crossfade button to display the dialog box.

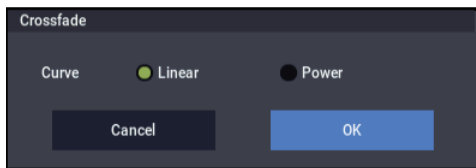

Use “Curve” to specify how the volume will change in the crossfaded portion.

Linear: The volume will change linearly.

Power: The volume will change in a non-linear power curve. Sometimes, using the Linear setting will produce the impression that the volume is less during the middle of the curve. If so, use the Power curve.

Press the OK button to execute the crossfade, or press the Cancel button if you decide to cancel.

11. When you’re finished with audio event editing, press the Done button.

By selecting the page menu command “Compare”, you can return to the state prior to your audio event editing operations.

Audio Automation Edit

This lets you edit individual automation data events. All edits are performed only on the single audio track that is selected, regardless of whether stereo pairing is on or off.

1. Use **Track Select** to select the audio track that you want to edit, and use **From Measure (4–1b)** to specify the first measure that you want to edit.

When you use **Track Select** to select Audio Track 01–16 and then choose “Automation Edit,” the Set Event Filters dialog box will appear.

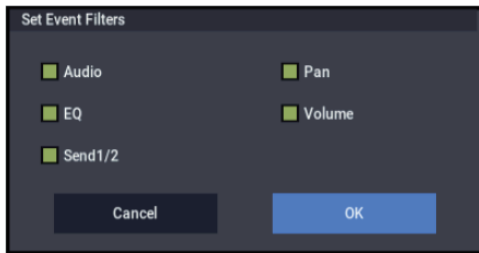

In the Set Event Filters dialog box, select the types of automation event data that you want to view or edit in the automation edit window.

Check each type of event (**Audio**, **Pan**, **EQ**, **Volume**, **Send 1/2**) that you want to see.

- Audio events are shown in this window for reference, but they cannot be edited here. To edit them, use the “Audio Event Edit” command.

2. Press the **OK** button to access the **Automation Edit** dialog box.

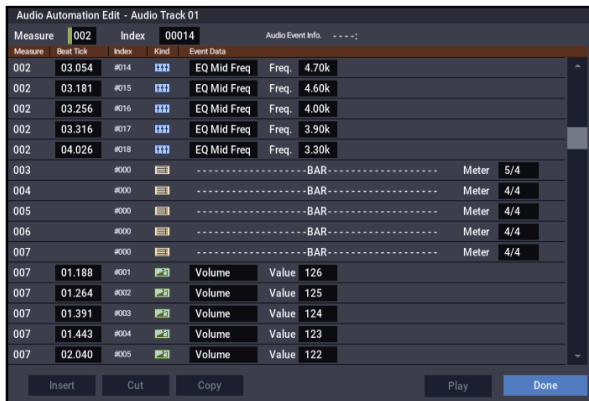

3. **Measure and Index** located in the top line of the dialog box show the measure for editing and the index number of an event within that measure; this event is shown at the top of the list of events.

You can use the scroll bar at right to move to the event you want to edit.

4. Select the event you want to edit, and use the **VALUE** controller to input the desired values.

- You can move the location of the event within the measure by editing the “Beat Tick” value.
- To edit the event data, input the desired values for each event.

5. You can press the buttons located at the bottom of the dialog box to edit events as follows.

- Inserting an event

Select the location “Beat Tick” at which you wish to insert an event, and press the Insert button to insert an event.

- Deleting an event

Select the event that you wish to delete, and press the Cut button to delete the event.

- Moving an event

You can use the Cut button and Insert button to move an event (by “cut and paste”).

Use the Cut button to delete the event that you wish to move, then use the Insert button to insert it at the desired location.

You can also move an event by modifying its “Beat Tick” value.

- Copying an event

Select the event that you wish to copy, and press the Copy button. Then select the copy destination and press the Insert button to insert the event at that location.

6. You can press the **Play** button to play back an audio event. During playback, an indication of “Stop” will appear, and you can stop playback by pressing this button.

Playback will also stop when you reach the end of the audio event. This is available only if you’ve selected an audio event.

7. When you’re finished with automation editing, press the **Done** button.

If desired, you can select the page menu command “Compare” to return to the state prior to automation editing.

The following table shows the types of “Automation Edit” events and the range of values.

| Kind | Value | Value2 |
|---|---------------|--|
| Region name (display only) (Audio events) | | E:001:00.000... 999:16.479(Display only) (End of an audio event: measure, beat, clock) |
| Volume | 000...127 | |
| Pan | 000...127 | |
| Send1 | 000...127 | |
| Send2 | 000...127 | |
| EQ Bypass | On, Off | |
| EQ Input Trim | 00...99 | |
| EQ High Gain | -18.0...+18.0 | |
| EQ Mid Freq | 100...10.00k | |
| EQ Mid Gain | -18.0...+18.0 | |
| EQ Low Gain | -18.0...+18.0 | |

Set Song Length

This command changes the length of the specified song. When it is executed, the length of the master track will change, and the number of measures played will change.

1. Select “Set Song Length” to open the dialog box.

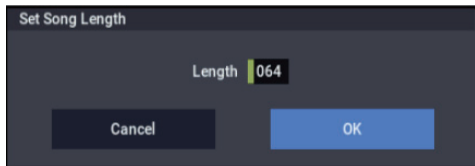

2. In “Length,” specify the length of the song.
3. To execute the Set Song Length command, press the OK button. To cancel without executing, press the Cancel button.

 All data following the measure specified by “Length” will be deleted. If you execute this command with “Length” shorter than the song, causing an audio event to extend beyond the end of the track, a new region will be automatically named and created to specify the region of the WAVE file that will actually be played.

The WAVE file itself will not be deleted.

Erase Track

This command erases the data from the specified track. It is not possible to erase the master track by itself.

1. In Track Select, select the track that you wish to erase.
2. Select “Erase Track” to open the dialog box.

MIDI tracks

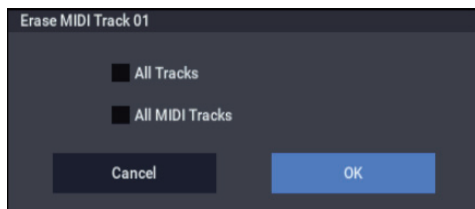

Audio tracks

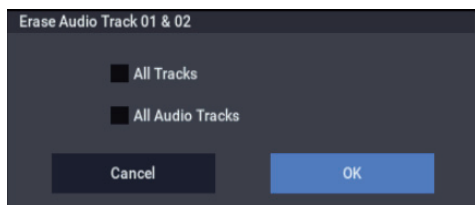

3. Select the track whose data you want to erase.
If you do not check **All Tracks**, **All MIDI Tracks**, or **All Audio Tracks**, only the playback data of the track you selected in **Track Select** will be erased.

If you check **All Tracks**, the playback data of all tracks (MIDI tracks, master track, and audio tracks) will be erased. WAVE files and regions will not be erased.

If you check **All MIDI Tracks** (when **Track Select** is set to a MIDI Track 01–16), the playback data of all MIDI tracks (MIDI Track 01–16) will be erased.

If you check **All Audio Tracks** (when **Track Select** is set to an Audio Track 01–16), the playback data of all audio tracks (Audio Track 01–16) will be erased.

Note: WAVE files and regions will not be erased.

4. Press the OK button to execute “Erase Track.” If you decide not to execute, press the Cancel button.

Copy Track

This command copies musical data from the copy source track to the specified track.

Be aware that the track data of the copy-destination will be erased when you execute the Copy Track operation.

1. Use Track Select to select the MIDI track (MIDI Track 01–16) or audio track (Audio Track 01–16) that you want to copy.
2. Select “Copy Track” to open the dialog box.

MIDI tracks

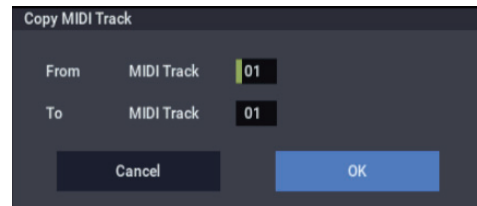

Audio tracks

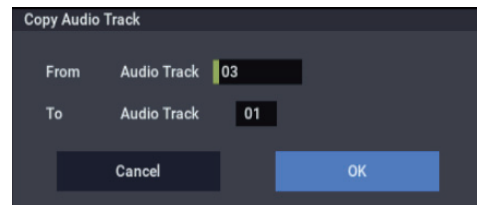

3. Use “From” to select the copy-source track, and “To” to select the copy-destination.

(By default, the track you choose in **Track Select** will be specified for “From”.)

When you copy an audio track, only the playback data (audio events and automation events) is copied; the WAVE files and regions are not copied.

 You can't copy between MIDI and audio tracks.

4. Press the OK button to execute the command. If you decide not to execute, press the Cancel button.

Bounce Track

This command combines the musical data of the bounce source and bounce destination tracks, and places the combined data in the bounce destination. All musical data in the bounce source will be erased.

If MIDI control data existed in the bounce source track and bounce destination track, unexpected results may occur during playback after the bounce command is executed. To prevent this from happening, use the “MIDI Event Edit” or “Erase Control Data” menu commands to edit the MIDI control data of the two tracks before you use Bounce Track.

1. Use Track Select to select the MIDI track (Track 01–16) that you want to bounce.
2. Select “Bounce Track” to open the dialog box.

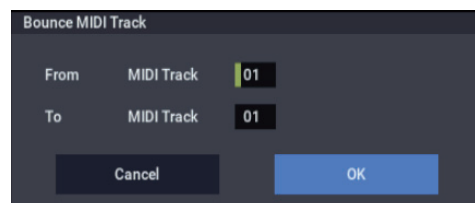

- Use “From” to select the bounce-source track, and “To” to select the bounce-destination track.
(By default, the track you choose in **Track Select** will be specified for “From”.)
- Press the **OK** button to execute the command. If you decide not to execute, press the **Cancel** button.
In the case of “Bounce Track,” the bounce-source track data will be set to “zero”.

Erase Measure

This command erases the specified type(s) of musical data from the specified range of measures. The Erase Measure command can also be used to remove only a specific type of data. Unlike the Delete Measure command, executing the Erase Measure command does not cause the subsequent measures of musical data to be moved forward.

- Use **Track Select** to select the MIDI track (MIDI Track 01–16) master track or audio track (Audio Track 01–16), that contains the measures of data you want to erase.
- Select “Erase Measure” to open the dialog box.

MIDI tracks

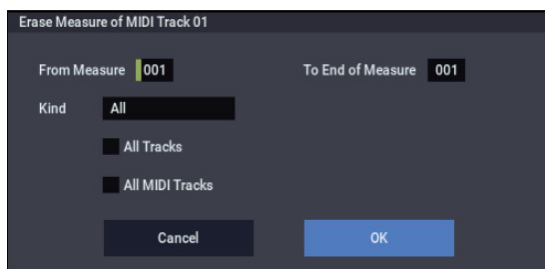

Audio tracks

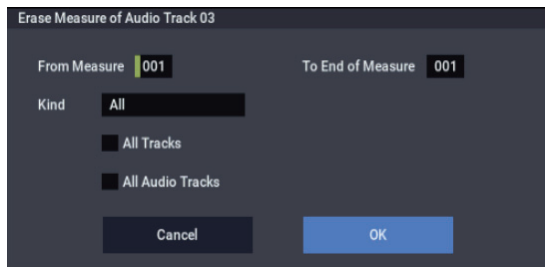

- In **From Measure** select the first measure to be erased, and in **To End of Measure** select the last measure to be erased.

(By default, **From Measure** and **To End of Measure** will be set to the range that you specified in the **Track Edit** page.)

- Use “**Kind**” to select the type of data you want to erase.

MIDI data:

All: Erases all types of data in that track, including note data.

Control Change: Erases control change data.

After Touch: Erases both channel pressure and poly key pressure data.

Pitch Bend: Erases pitch bend data.

Program Change: Erases program change data.

Exclusive: Erases exclusive data.

Audio data:

All: Erase all data from that track.

Audio Event: Erase audio events.

Automation Event: Erase all automation events (EQ, Send 1/2, Pan, Volume).

EQ: Erase only EQ data (Bypass, Input Trim, High Gain, Mid Cutoff, Mid Gain, Low Gain).

Send 1/2: Erase only Send 1 and Send 2 data.

Pan: Erase only pan data.

Volume: Erase only volume data.

- Select the track(s) for which you want to execute the command.

If you execute with **All Tracks**, **All MIDI Tracks**, and **All Audio Tracks** unchecked, the specified “Kind” of data will be erased only from the track that’s selected in **Track Select**.

If you check **All Tracks**, the specified “Kind” of data will be erased from all tracks.

If you check **All MIDI Tracks** (when a MIDI Track is selected), the specified “Kind” of data will be erased from all MIDI tracks (MIDI Tracks 01–16).

If you check **All Audio Tracks** (when an Audio Track is selected), the specified “Kind” of data will be erased from all audio tracks (Audio Tracks 01–16).

- To execute the Erase Measure command, press the **OK** button. To cancel, press the **Cancel** button.

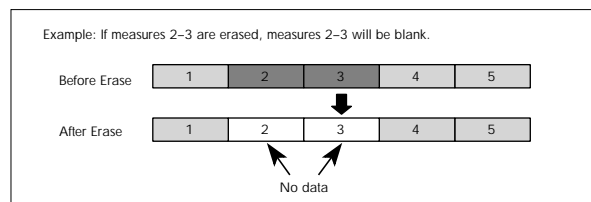

If data extends across the boundary between a measure being erased and a measure that is not being erased, only the portion that falls within the specified region will be erased.

Be aware that if note data extends across several measures, and you erase a measure that falls in the middle of the note, that note data will disappear from the subsequent measures as well.

Note: Note data can also be erased using the “Shift/Erase Note” menu command. Use this command when you wish to erase a specific range of notes, or to erase notes from a specific **Beat.Tick**.

Note: Control Change data can also be erased using the “Erase Control Data” menu command. Use this when you wish to erase a specific type of control change, or to erase control change data from a specific **Beat.Tick** range.

If you erase a portion of an audio event that extends across several measures, a new region that changes the region of the WAVE file that is played back will automatically be created and named.

Note: The WAVE file will not be deleted.

Delete Measure

This command deletes the specified measures.

When the Delete Measure command is executed, the musical data following the deleted measures will be moved towards the beginning of the sequence.

1. Use **Track Select** to select the **MIDI track (MIDI Track 01–16) or audio track (Audio Track 01–16) that contains the measures you want to delete.**
2. Select **“Delete Measure”** to open the dialog box.

MIDI tracks

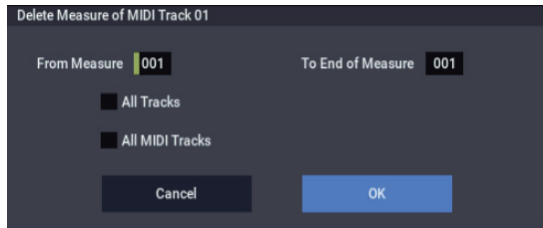

Audio tracks

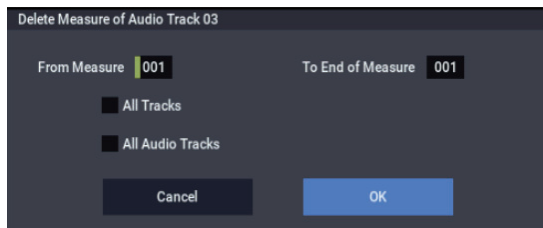

3. In **From Measure** select the first measure that you wish to delete, and in **To End of Measure** select the last measure that you wish to delete.

By default, the range of measures will be set as specified on the Track Edit page.

4. Specify the track(s) on which you want to execute the command.

If you execute with **All Tracks**, **All MIDI Tracks**, and **All Audio Tracks** unchecked, the specified measures of data will be deleted only from the track that's selected in **Track Select**.

If you check **All Tracks**, the specified measures of data will be deleted from all tracks.

If you check **All MIDI Tracks** (when a MIDI track is selected), the specified measures of data will be deleted from all MIDI tracks.

If you check **All Audio Tracks** (when an Audio track is selected), the specified measures of data will be deleted from all audio tracks.

5. To execute the Delete Measure command, press the **OK** button. To cancel, press the **Cancel** button.

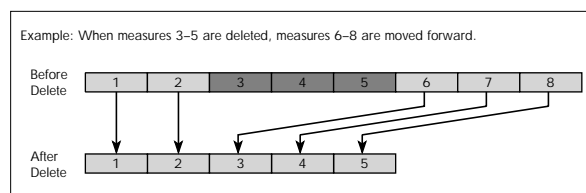

- ⚠ If in step 4 you uncheck **All Tracks** and execute this operation, the measures will not be deleted from the master track. Time signature and tempo data will remain unchanged, and the time signature and tempo of the measures that were moved forward as a result of the Delete operation will change.

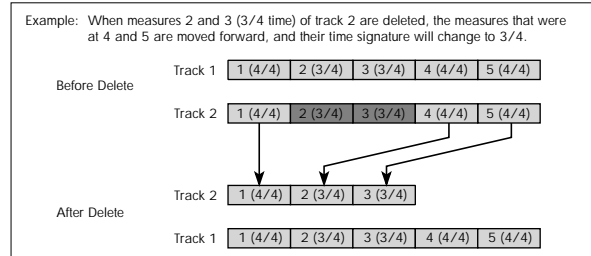

- ⚠ If in step 4 you check **All Tracks** and execute this operation, the specified measures of musical data will be deleted from all tracks including the master track, and the time signature and tempo will also move forward by the number of measures that were deleted.
- ⚠ If note data extends across several measures, and you delete a measure that falls in the middle of the note, that note data will disappear from the subsequent measures as well.
- ⚠ If you erase a portion of an audio event that extends across several measures, a new region that changes the region of the WAVE file that is played back will automatically be created and named.

Note: The WAVE file will not be deleted.

Insert Measure

This command inserts the specified number of measures into the specified track. Existing data following the insert location will be moved backward.

If you insert measures between note events that are connected by a tie, a note-off will be created immediately before the inserted measure, and the subsequent portion will be deleted.

1. Use **Track Select** to select the **MIDI track (MIDI Track 01–16) or audio track (Audio Track 01–16) into which you want to insert measures.**
2. Select **“Insert Measure”** to open the dialog box.

MIDI tracks

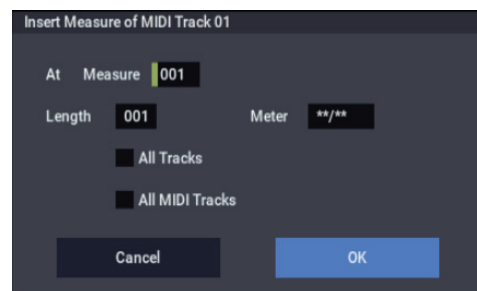

Audio tracks

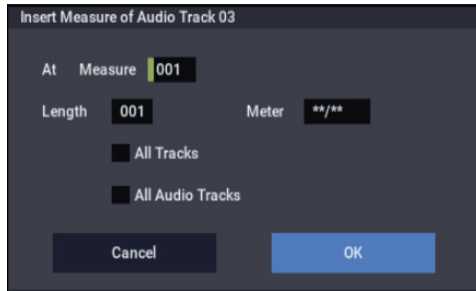

3. In “At Measure,” specify the measure location at which the data will be inserted. (The measure you specified in Track Edit page From Measure will be set as a default.)

4. In “Length,” specify the number of measures that will be inserted.

5. In Meter, specify the time signature of the measures that will be inserted.

If you want the inserted measures to match the existing time signature, specify **/**. With any setting other than **/**, the time signature of the inserted measures will change, and the specified time signature will apply to all tracks for those measures.

6. Specify the track(s) for which you want to execute the command.

If you execute with **All Tracks**, **All MIDI Tracks**, and **All Audio Tracks** unchecked, the measures will be inserted into the track that’s selected in **Track Select**. Be aware that at this time, the playback data that follows the insert location will move toward the end of the song according to the number of inserted measures, but the time signature and tempo will not move.

If you check **All Tracks**, the measures will be inserted into all tracks including the Master Track. The playback data in subsequent measures will play just as it did before this command was executed.

If you check **All MIDI Tracks** (when a MIDI track is selected), the measures will be inserted into all MIDI tracks.

If you check **All Audio Tracks** (when an Audio track is selected), the measures will be inserted into all audio tracks.

7. To execute the Insert Measure command, press the **OK** button. To cancel, press the **Cancel** button.

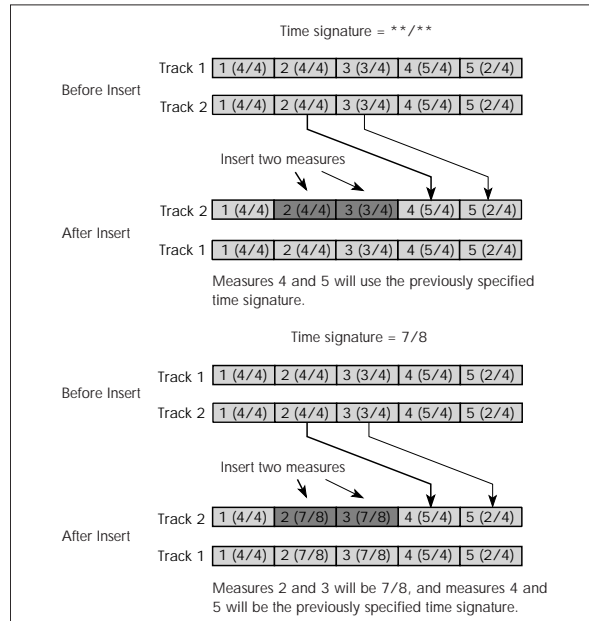

⚠ If you execute Insert Measure at a location in the middle of an audio event that spans several measures, two new regions that play the regions divided at the “At Measure” will be automatically created and named.

Note: The WAVE file itself will not be modified.

Repeat Measure

This command repeatedly inserts the specified measures for the specified number of times. When you execute the Repeat Measure command, the measures will be inserted following the measure specified by **To End of Measure**, and musical data following the inserted data will be moved backward. It is convenient to use this command when you have a song that you playback with “Track Play Loop” (0–3a) turned on, and wish to expand it into musical data.

1. Use **Track Select** to select the **MIDI track (MIDI Track 01–16)** or **audio track (Audio Track 01–16)** that you want to insert data into.

2. Select “Repeat Measure” to open the dialog box.

MIDI tracks

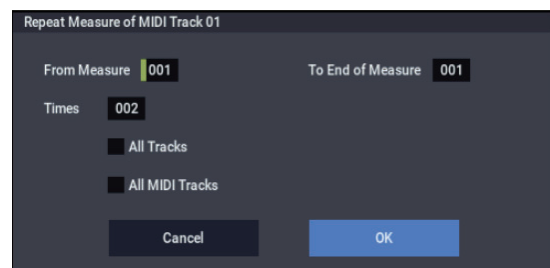

Audio tracks

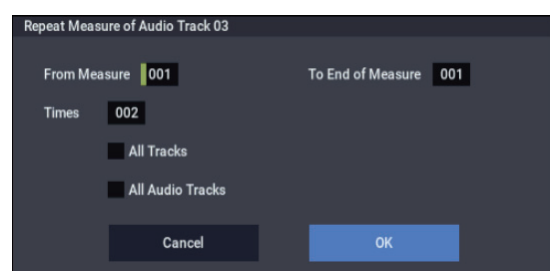

3. In From Measure and To End of Measure, specify the range of measures that will be repeated.

By default, the range of measures will be set as specified on the Track Edit page.

4. In Times, specify the number of repetitions.

For example if you set **From Measure** to 001, **To End of Measure** to 004, and **Times** to 2, the musical data of measures 1–4 will be inserted into measures 5–8. The result will be that measures 1–4 will be played twice.

5. Specify the track(s) for which you want to execute the command.

If you execute with **All Tracks**, **All MIDI Tracks**, and **All Audio Tracks** unchecked, the playback data will be inserted into the track that's selected in **Track Select**. Be aware that at this time, the playback data that follows the inserted location will move toward the end of the song according to the number of inserted measures, but the time signature and tempo will not move.

If you check **All Tracks**, the playback data will be inserted into all tracks including the Master Track. The playback data in subsequent measures will play just as it did before this command was executed.

If you check **All MIDI Tracks** (when a MIDI track is selected), the data will be inserted into all MIDI tracks.

If you check **All Audio Tracks** (when an Audio track is selected), the data will be inserted into all audio tracks.

6. To execute the Repeat Measure command, press the OK button. To cancel, press the Cancel button.

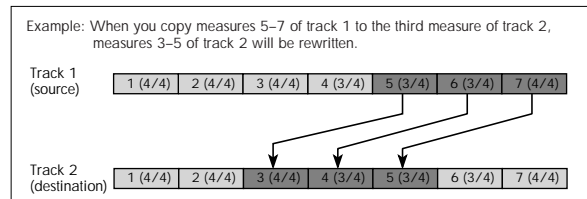

If you execute Repeat Measure at a location in the middle of an audio event that spans several measures, a new region will be automatically created and named.

Note: The WAVE file itself will not be modified.

Copy Measure

This command copies the measures of musical data specified as the “From” source to the beginning of the measure specified as the “To” location.

When you execute the Copy Measure command, the existing track data at the copy destination will be rewritten.

1. Select the copy source song.
2. Select “Copy Measure” to open the dialog box.

MIDI tracks

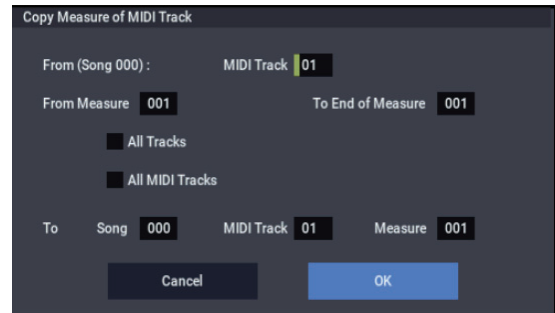

Audio tracks

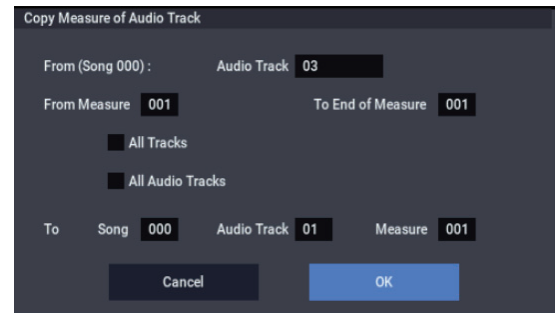

3. Use From: Track or “Audio Track” to select the copy-source track.

(By default, this will be the **Track Select** track.)

If you execute with **All Tracks**, **All MIDI Tracks**, and **All Audio Tracks** unchecked, only the selected track will be copied. Note that the time signature and tempo will not be copied.

If you check **All Tracks**, the playback data of all tracks including the Master Track will be copied.

If you check **All MIDI Tracks** (when a MIDI Track is selected), all MIDI tracks will be copied.

If you check **All Audio Tracks** (when an Audio Track is selected), all audio tracks will be copied.

4. In From Measure and To End of Measure, specify the range of copy source measures.

By default, the range of measures will be set as specified on the Track Edit page.

5. Use To: Song to select the copy-destination song, use Track or “Audio Track” to select the copy-destination track (if you haven’t checked All Tracks, All MIDI Tracks, or All Audio Tracks), and use Measure to select the measure at which the copied data will be inserted.

You can’t copy between MIDI and audio.

6. To execute the Copy Measure operation, press the OK button. To cancel, press the Cancel button.

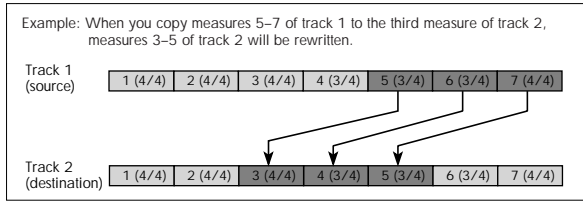

If the copy-source you specify is a portion of an audio event that spans several measures, or if the copy-destination is a portion of an audio event that spans several measures, a new region will automatically be created and named when you execute the Copy Measure command.

Note: The WAVE file itself will not be modified.

Move Measure

This command moves the specified measures to another location. Existing data at the destination will be pushed back to make room for the moved data, and the data surrounding the old location will be moved to fill in the gap.

1. Select “Move Measure” to open the dialog box.

MIDI tracks

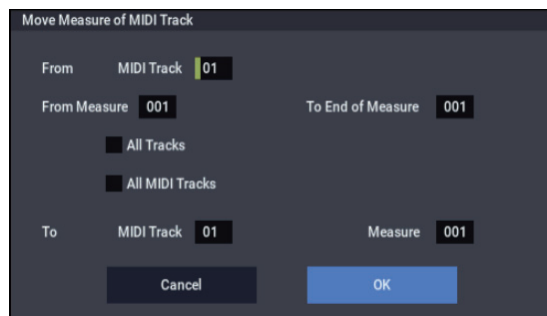

Audio Tracks

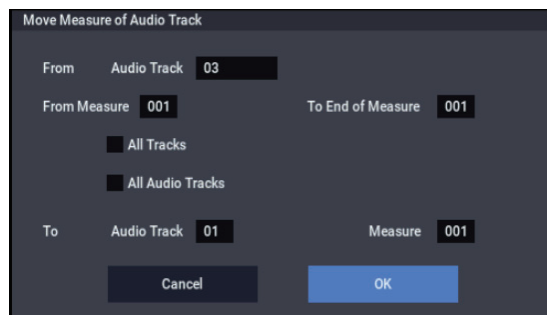

2. Use **From: Track** or “**Audio Track**” to select the move-source track.

(By default, this will be the **Track Select** track.)

If **All Tracks**, **All MIDI Tracks**, and **All Audio Tracks** are unchecked, only data from the selected track will be moved.

If you check **All Tracks**, the playback data of all tracks including the Master Track will be moved.

If you check **All MIDI Tracks** (when a MIDI Track is selected), all MIDI tracks will be moved.

If you check **All Audio Tracks** (when an Audio Track is selected), all Audio tracks will be moved.

3. Use **From Measure** and **To End of Measure** to specify the region of measures that will be moved.

By default, the range of measures will be set as specified on the Track Edit page.

4. Use **To: Track** or “**Audio Track**” (if you haven’t checked **All Tracks**, **All MIDI Tracks**, or **All Audio Tracks**) to select the destination track, and use **Measure** to select the starting measure at which the data will be inserted.

You can’t move between MIDI and audio.

5. To execute the **Move Measure** command, press the **OK** button. To cancel, press the **Cancel** button.

If you move a portion of an audio event that spans several measures, or if you move to a portion of an audio event that spans several measures, a new region will automatically be created and named when you execute the **Move Measure** command.

Note: The WAVE file itself will not be modified.

Create Control Data

This command creates control change, aftertouch, pitch bend, or tempo data in the specified region of a MIDI track or the master track.

1. In **Track Select**, select the MIDI track on which you wish to perform the **Create Control Data** command.

If you wish to modify tempo data, select Master Track as the track. In this case, the step 4 item “**Kind**” will be set to “**Tempo**.”

2. Select “**Create Control Data**” to open the dialog box.

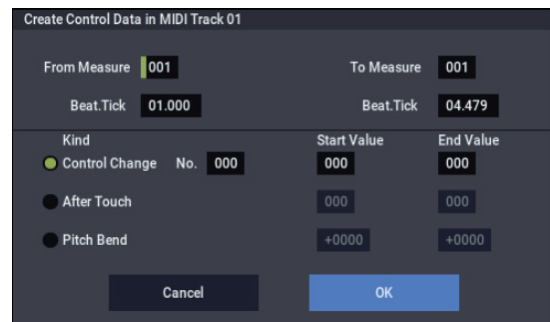

3. Specify the range into which the control data will be inserted.

In **From Measure** and **To End of Measure** specify the measures, and in **Beat.Tick** specify the beat and clock. (By default, the range of measures will be set as specified on the Track Edit page.)

4. Set “**Kind**” to the type of musical data (event) that you wish to create.

Control change: Control change data will be inserted. Use “#” to specify the CC number.

After Touch: Aftertouch data will be inserted.

Pitch Bend: Pitch bend data will be inserted.

Tempo: Tempo data will be inserted (if you’ve selected the master track).

5. In “**Start Value**,” select the starting value of the control data. In “**End Value**,” select the ending value of the control data.

By default, the “**Start Value**” will be set to the value of the existing data at the start location. If you wish to create control data that changes smoothly from the starting

location, you can leave the “Start Value” unchanged, and set only the “End Value.”

- To execute the Create Control Data command, press the OK button. To cancel, press the Cancel button.

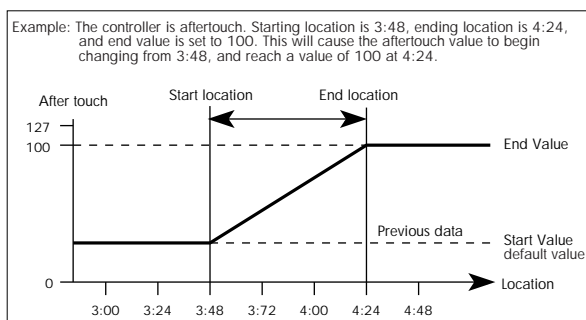

When you execute Create Control Data, a large amount of sequencer memory will be consumed. For this reason it may not be possible to execute this command if there is a limited amount of memory remaining. In such cases, first use the “Quantize” menu command to quantize the data and remove unnecessary control data. Alternatively, you could quantize the data inserted by the Create Control Data command.

Erase Control Data

This command erases data such as control changes, after touch, pitch bend, or tempo in the specified range.

- In Track Select, select the MIDI track from which you wish to erase control data.

If you wish to erase tempo data, select Master Track. In this case, the “Kind” item in step 4 will be Tempo.

- Select “Erase Ctrl Data” to open the dialog box.
- Specify the range from which you wish to erase control data.

In **From Measure** to **To End of Measure** specify the measures, and in **Beat.Tick** specify the beat and clock. (By default, **From Measure** and **To End of Measure** will be the range that was specified in the Track Edit page.)

- Set “Kind” to the type of musical data (event) that you wish to erase.

Control change: Control change data will be erased. Use “#” to specify the control change number.

After Touch: Aftertouch data will be erased.

Pitch Bend: Pitch bend data will be erased.

Tempo: Tempo data will be erased. (If you’ve selected the master track)

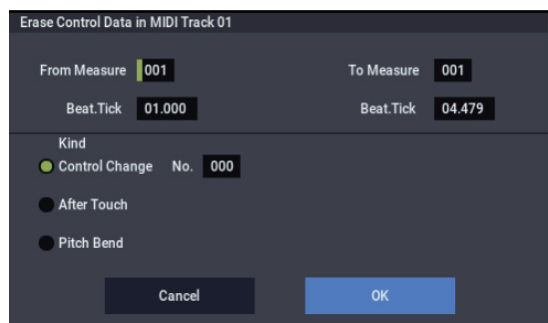

- To execute the Erase Control Data command, press the OK button. To cancel, press the Cancel button.

Note: To erase all control change data from specified measures, you can also use the “Erase Measure” menu command, and set “Kind” to Control Change. However, the Erase Control Data command allows you to specify the range using **Beat.Tick**, and also to erase only specific types of control change data.

Quantize

This command corrects the timing of MIDI data of the type you specify (note data, control change, aftertouch, pitch bend, program change, etc.) in the track.

When you execute the Quantize operation, the musical data will be affected as follows:

- When quantizing note data, only the timing of the note-on is affected; the length (duration of the note) is not affected.
- If the Quantize resolution is set to Hi, the timing will be adjusted to the base resolution ($\sqrt[4]{480}$), so note data will not be affected. However, continuous controller data such as joystick or after touch will be processed so that duplicate events on the same “tick” are combined into a single event, thus conserving memory.

Similarly, two or more data events of an identical type existing at the identical timing will be combined into one, also conserving memory.

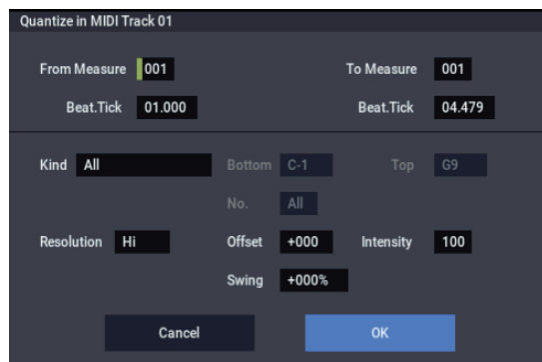

- In Track Select, specify the track.
- Select “Quantize” to open the dialog box.
- Specify the range that will be quantized.
- In “Kind,” select the type of musical data (events) that you wish to quantize.

All: Quantization will be applied to all performance MIDI data.

Note: Quantization will be applied only to note data.

Bottom specifies the lowest Note that will be affected, and **Top** specifies the highest Note. You can use this when you want to quantize only a specific note or notes (for example, just the snare sounds of a drum track). If you want to quantize all notes, set these parameters C-1 and G9 respectively. These note settings can be entered by holding down the ENTER button and playing a note on the keyboard.

Control Change: Quantization will be applied to control changes. To quantize only a specific control change,

specify the number (“No.”). To quantize all control changes, select All.

After Touch: Quantize both Channel Pressure and Polyphonic Key Pressure messages.

Pitch Bend: Pitch bend data will be quantized.

Program Change: Program change data will be quantized.

5. In “Resolution,” specify the timing resolution to which the data will be corrected.

Lower resolutions can save memory, but if you set it too low, the timing may not be acceptable.

6. In “Offset,” specify the number of clock ticks by which the data will be moved forward or backward relative to the standard timing.

48 is a 16th-note; 96 is an 8th-note. Positive (+) settings move the timing forwards, and negative (–) settings move it backwards. This allows you to “push” or “drag” the beat.

7. In “Intensity,” specify the degree of sensitivity to which the timing will be corrected; i.e., how close to the locations specified by step 5 and 6 the data will be moved.

With a setting of 0, no correction will take place. With a setting of 100, the data will be moved all the way to the timing intervals specified by step 5 and 6.

By varying the **Offset** and **Intensity** settings, you can create quantization effects such as the following:

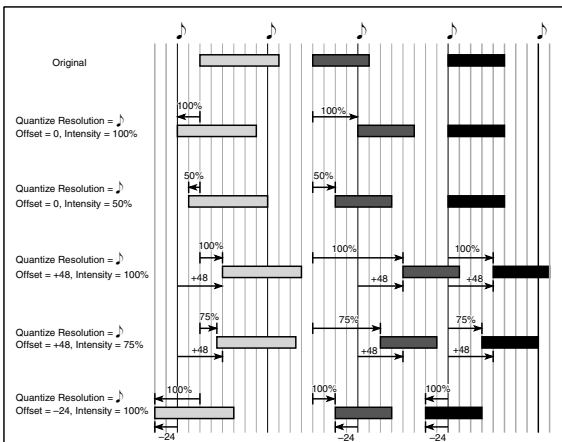

8. Use “Swing” to add a sense of swing to the rhythm. For example, this is an easy way to give a slight shuffle groove to a “square” 16-beat rhythm.

Settings other than 0% will adjust the positions of notes at even-numbered beats relative to the specified “Resolution.”

With a setting of +100%, notes will be moved one third of the way toward the specified “Resolution.” With a setting of +300%, notes of even-numbered beats will be moved all the way to the next even-numbered beat.

By varying the **Swing** settings, you can create effects such as the following:

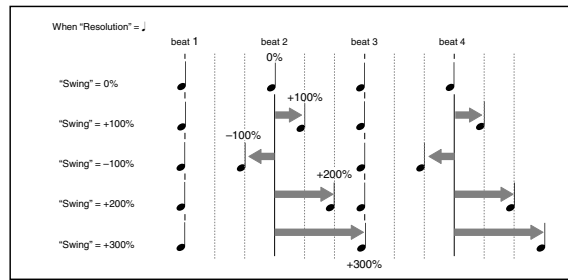

9. To execute the Quantize command, press the OK button. To cancel, press the Cancel button.

Shift/Erase Note

This command shifts (moves) or erases the specified note numbers in a specified MIDI track and range of measures.

- 1. In Track Select, select the MIDI track on which you wish to execute the Shift/Erase Note command.**
- 2. Select “Shift/Erase Note” to open the dialog box.**

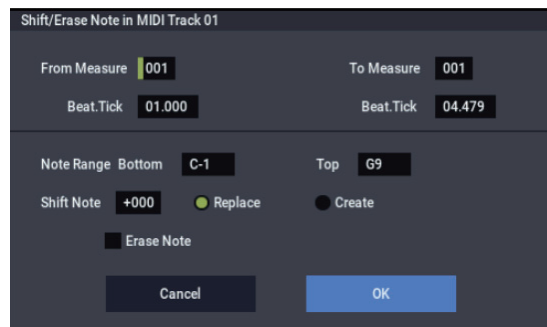

3. Specify the range in which you wish to shift or erase note numbers.

In **From Measure** and **To End of Measure**, specify the measures. In **Beat.Tick**, specify the beat and clock. (By default, **From Measure** and **To End of Measure** will be the range that you specified in the Track Edit page.)

4. Specify the range of notes that you wish to shift or erase.

Note Range: **Bottom** specifies the lower limit, and **Top** specifies the upper limit. If you wish to edit all notes, set **Bottom** to C–1 and **Top** to G9. These settings can also be made by holding down the ENTER button as you play a note.

- Shifting notes
- 5. In “Shift Note,” specify the amount by which you wish to move the note.**

The amount of shift is set in semitone steps over a range of –127–+127. +1 will shift the note a semitone upward.

6. Select either “Replace” to move the note numbers, or “Create” to generate additional notes.

For example if you are editing a track that uses a drum program, you can use “Replace” to exchange the current snare sound for a different snare sound assigned to a different key, or use “Create” to add a sound effect at a different note # to the snare sound. Alternatively, you can use “Create” to add an octave doubling to an existing guitar phrase, etc.

7. To execute the Shift Note command, press the OK button. To cancel, press the Cancel button.

- Erasing notes

8. Check “Erase Note.”

If you wish to erase all note data in the specified range of measures, you can also use the “Erase Measure” menu command and set “Kind” to Note. However, this Shift/Erase Note command lets you specify the **Beat.Tick** range, and to erase only specific ranges of note data.

9. To execute the Erase Note command, press the OK button. To cancel, press the Cancel button.

Modify Velocity

This command modifies the velocity values of notes in the specified area so that they will change over time according to a selected curve.

- In **Track Select**, specify the track whose velocity will be modified.
- Select **“Modify Velocity”** to open the dialog box.

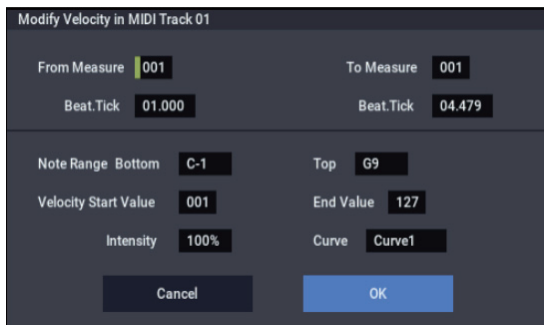

- Specify the range in which note velocity will be modified.
From Measure and **To End of Measure** specify the measure, and **Beat.Tick** specify the beat and clock. (By default, **From Measure** and **To End of Measure** will be set to the range that you specified in the Track Edit page.)
- Specify the range of notes that will be affected by the **Modify Velocity** command.
Note Range: Bottom is the lower limit, and **Top** is the upper limit. If you wish to edit all notes, set **Bottom** to C-1 and **Top** to G9. These settings can also be made by holding down the ENTER button as you play a note on the keyboard.
- In **“Velocity Start Value”** specify the value at which the velocity data will start, and in **“End Value”** specify the final velocity value.
 These settings can also be made by holding down the ENTER button as you play a note on the keyboard.
- In **“Intensity,”** specify the degree to which the velocity data will be adjusted toward the curve you specify in step 7.
 With a setting of 0 [%], the velocity will not change. With a setting of 100 [%], the velocity will be exactly as described by the curve.
- “Curve”*** lets you select from six types of curve to specify how the velocity will change over time.
 The six curves are as follows:

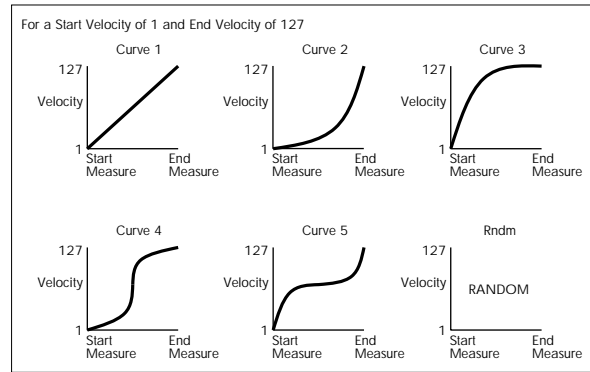

8. To execute the Modify Velocity operation, press the OK button. To cancel, press the Cancel button.

Region Edit

Here’s how to edit the regions used in an audio track.

In addition to Importing or Pasting a region, you can use the Trim dialog box to specify the range in which a WAVE file will play back.

- Editing a region will affect all audio tracks of the song. Use caution when editing a region that is already used by an audio track.

- Use **Track Select** to select an **Audio Track**.
- Choose **“Region Edit”** to open the region edit dialog box.



- Use **Index** at the top of the dialog box to specify the index number of the region you want to edit; this will be displayed at the beginning of the list in the dialog box.
 You can also touch the scroll bar at the right to move to the region you want to edit.
 If you check **Song**, only regions of the specified song number and audio track number will be displayed. This is convenient if you have difficulty finding the region you want to edit.
 The song number and audio track number of a region is specified when it is recorded. You can also modify these in the Trim dialog box (step 6).
- If you want to edit the region name, press the text edit button.
 Press the text edit button to open the dialog box, and set the name as desired (up to 24 characters). If a USB

QWERTY keyboard (commercially available) is connected, you can use this to enter text instead of the on-screen keyboard.

Regions whose names are shown as “=No Assign=” are empty. You cannot edit these names.

5. Select the region that you want to edit, and use the buttons at the bottom of the dialog box to edit the region.

The available buttons will differ depending on whether you’ve checked **Song**.

- Importing a region

You can copy a region from a .SNG file, or create a region from a WAVE file.

Select the region that you want to import, and press the Import button.

The Import dialog box will appear.



Use “Drive Select,” “Open,” and “Up” to move to the desired directory, select the region file or WAVE file you want to import, and press OK.

You can use “Name” in the upper line to edit the name of the region. Edit “Name” after you’ve selected a file.

Important: You can only directly import WAVE files from the internal hard drive. To use files from CDs or external USB devices, you must first copy them to the internal hard drive, and then import the copied file into the Song.

- *Note:* You can only import WAVE files with a sample rate of 44.1 or 48 kHz, and which are no longer than 80 minutes.

When you press the Play button, the selected WAVE file will play. (Play is available only for 44.1 and 48 kHz WAVE files). See also “WAVE files” on page 241 of the OG.

- Copying a region

Select the copy-source region and press the Copy button. Then select the copy-destination and press the Paste button or Insert button to paste (overwrite) or insert the region into that destination.

Commands that are available if Song is unchecked

- Paste region

Select the region to which you want to paste, and press the Paste button to overwrite that region.

- Clear region

Select the region that you want to clear, and press the Clear button to clear that region.

Commands that are available if Song is checked

- Insert region

Select the region at which you want to insert, and press the Insert button to insert a region.

- Cut region

Select the region that you want to cut (delete), and press the Cut button to delete that region.

6. Play back the region.

Select the region that you want to play back, and press the Play button to play the region from its “Start” to “End” (Trim step 6). During playback, the Play button indication will change to Stop. You can press the Stop button to stop playback.

7. Use the trim dialog box to specify the portion of the region that will play back.

In the trim dialog box, select the region that you want to edit and press the Trim button to open the trim dialog box.

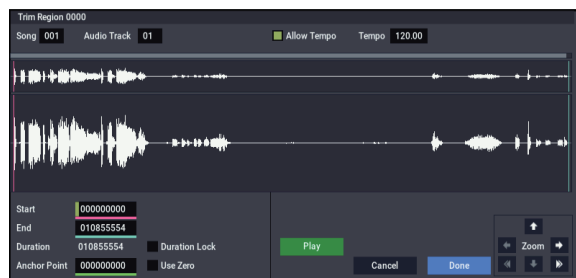

WAVE file waveform display, ZOOM

This area shows the waveform of the WAVE file that is assigned to the region.

The waveform display and the ZOOM buttons are the same as in SAMPLING mode, except for the fact that the displayed data is a WAVE file. Refer to SAMPLING mode “1-1c: Sample waveform display” on page 586 and “1-1f: ZOOM” on page 587.

Start [0000000...230399998]

End [0000001...230399999]

“Start” and “End” specify the range (start address and end address) of the waveform that will be played. The range you specify here is highlighted in the “WAVE file display.”

Duration

This indicates the length between “Start” and “End.” (You can’t edit this indication.)

Anchor Point [0000000...230399999]

Here you can specify an anchor point, which is convenient when you need to move an audio event. (The value is shown in samples.)

Anchor points are used in audio event editing.

Use Zero [Off, On]

On: When you edit “Start,” “End,” or “Anchor Point,” you will be able to select only “zero-cross” addresses; locations at which the waveform level crosses the center line of the sample waveform display, and is therefore at ±0. When you operate the VALUE dial, or +/- buttons, the next or previous zero-cross point will be automatically found and selected. If you use the numeric keys to enter a value, the nearest zero-cross address will be found automatically.

Off: You will be able to specify “Start,” “End,” and “Anchor Point” in units of a single sample. This is the normal setting.

Duration Lock [Off, On]

This specifies whether the length between “Start” and “End” will be fixed during editing.

On: If you edit the “Start” or “End” address, the “End” or “Start” address will automatically be adjusted to preserve the existing length between “Start” and “End.”

Allow Tempo [Off, On]

This specifies whether the Region’s Tempo (see “Tempo [40.00...300.00],” below) will be used when executing the menu commands “Adjust Region to Song’s Tempo” or “Adjust Song’s Tempo to Region.”

Normally you will leave this turned on, and turn it off only when using “one-shot” samples such as rhythm instruments whose length you don’t want to change even if the tempo is changed.

This is turned on when you record or import.

Tempo [40.00...300.00]

This specifies the tempo of the region.

This tempo is used when executing the “Adjust Region to Song’s Tempo” or “Adjust Song’s Tempo to Region” page menu commands.

For more information, please see “Adjust Region to Song’s Tempo” on page 550, and “Adjust Song’s Tempo to Region” on page 550.

The tempo at the beginning of recording is set at the time of recording. With imported audio files, the tempo is set to 120.00.

Song [000...199]

Audio Track [01...16]

These specify the song number and audio track that are displayed when viewing regions for each audio track if you’ve checked **Song** for “Select Region” when using “Edit Region” or “Audio Event Edit.” For details, see step 2.

Play/Stop Play

When you press the Play button, the area from “Start” to “End” will play back, allowing you to audition the trimmed region. During playback, the button is displayed as Stop; playback will stop if you press it.

8. **If you want to keep the changes you made in the Trim dialog box, press the Done button.**

If you don’t want to save your changes, press the Cancel button. If you press the Cancel button, the region will revert to the state prior to entering the Trim dialog box.

9. **When you’re finished with Region Edit, press the Done button.**

Volume Ramp

This command modifies the data values (volume) of the specified area. You can gradually increase (Fade In) or decrease (Fade Out) the volume between the start and end points.

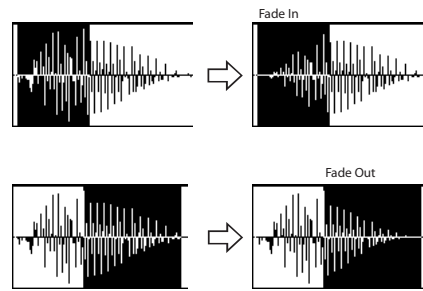

1. **Use Track Select to select the audio track that you want to edit, and use From Measure and To End of Measure to specify the area that you want to edit.**
2. **Choose “Volume Ramp” to open the dialog box.**

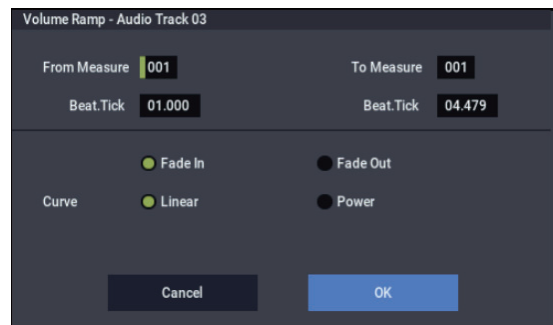

3. **Use From Measure, “To Measure,” and Beat.Tick to specify the area on which you will execute the command.**

Specify the desired measures in **From Measure** and “To Measure,” and specify the beat and clock in **Beat.Tick**. By default, **From Measure** and “To Measure” are set to the range of measures you specified in **From Measure** and **To End of Measure** of the Track Edit page.

4. **Use the radio buttons to select the type of volume ramp.**

Fade In: The volume will be zero at the beginning of the range, and will gradually increase toward the original volume at the end of the range.

Fade Out: The volume will gradually decrease from the beginning of the range, reaching zero at the end of the range.

5. **Use “Curve” to select how the volume will change.**

Linear: The volume will change linearly. Choose the Linear setting for a conventional fade-in or fade-out.

Power: The volume will change non-linearly. In some cases, such as when you use the “Mix” menu command to mix (cross-fade) a faded-in waveform with a faded-out waveform, using the Linear setting may produce the impression that the volume is lower during the transition. If so, use the Power setting.

6. **Press the OK button to execute the Volume Ramp, or press the Cancel button if you decide to cancel.**



Note: When you execute this command, a new region and WAVE file will be created, and the file will be named automatically. The audio event will also be updated. Automation events will not be affected.

Copy Song's Tempo to Region

This command changes the tempo used by the specified regions of audio events so that the audio event tempo will match the tempo of the location in which those regions play back.

If the tempo of an audio track matches the tempo of the MIDI tracks, executing this command to match the region tempo will ensure that the “Adjust Region to Song’s Tempo” or “Adjust Song’s Tempo to Region” commands can be executed correctly.

Note: The tempo of a region is specified at the time of recording. You can also modify it using Trim in “Audio Event Edit.”

-  The tempo will not be copied if “Allow Tempo” (Trim Dialog) is Off.
- 1. Use **Track Select** to select the track to which you want to copy the tempo.
- 2. Choose “**Copy Song’s Tempo to Region**” to open the dialog box.
- 3. Use **From Measure** to select the first measure to which you want to copy the tempo, and use **To End of Measure** to select the last measure.
(By default, **From Measure** and **To End of Measure** will be the range of measures you specified in the Track Edit page.)
- 4. If you want to copy the sequencer tempo to all audio tracks, check **All Audio Tracks**.
If this is not checked, the tempo data will be copied to the track you specified in **Track Select**.
- 5. Press the **OK** button to execute the **Copy Song’s Tempo to Region** command, or press the **Cancel** button to cancel without executing.
-  Executing this command will modify the region(s). Be aware that editing a region will affect the audio tracks of the entire song. Use caution when editing regions that are used by other audio tracks.

Note: This command will not affect audio events, automation events, or WAVE files.

Adjust Song's Tempo to Region

This command creates tempo events in the master track to match the tempo of the regions used by the audio events in the specified range.

This is useful if you create audio tracks in a previously-recorded region, and want all tracks (including MIDI tracks) to match that region.

Note: The tempo of a region is specified at the time of recording. You can also modify it using Trim in “Audio Event Edit.”

-  Tempo events will not be created if “Allow Tempo” (Trim Dialog) is Off.
- 1. Use **Track Select** to select the track whose tempo you want to reference.
- 2. Choose “**Adjust Song’s Tempo to Region**” to open the dialog box.
- 3. Use **From Measure** to select the first measure in which you want to create tempo events, and use **To End of Measure** to select the last measure.

(By default, **From Measure** and **To End of Measure** will be the range of measures you specified in the Track Edit page.)

- 4. If you want to create tempo events based on all audio tracks, check **All Audio Tracks**.
If this is not checked, the track you specified in **Track Select** will be used as the basis for the tempo events that are created.
- 5. Press the **OK** button to create the tempo events, or press the **Cancel** button to cancel.

Adjust Region to Song's Tempo

If the tempo of regions used by audio events in the specified range differs from the tempo of the range in which those regions play back, you can execute **Time Stretch** (Sustaining) to create new WAVE files and regions. Audio events that use the newly created regions will also be created automatically.

If you want to change the tempo of a song you’ve already created, you can first execute “**Copy Song’s Tempo to Region**” so that the tempo of the master track etc. matches the song tempo and region tempo. Then you can create an audio track that matches the new tempo.

Note: The tempo of a region is specified at the time of recording. You can also modify it using Trim in “Audio Event Edit.”

-  The **Time Stretch** command will not be executed if “Allow Tempo” (Trim Dialog) is Off.
- 1. Use **Track Select** to select the track for which you want to execute the **Time Stretch** command.
- 2. Choose “**Adjust Region to Song’s Tempo**” to open the dialog box.
- 3. Use **From Measure** to select the first measure to which you want to apply **Time Stretch**, and use **To End of Measure** to select the last measure.
(By default, **From Measure** and **To End of Measure** will be the range of measures you specified in the Track Edit page.)
- 4. If you want to apply **Time Stretch** to all audio tracks, check **All Audio Tracks**.
If this is not checked, the **Time Stretch** command will be applied to the track you specified in **Track Select**.
- 5. Use “**Quality**” to specify the audio quality of the sample that is produced by the **Time Stretch** command.

You can choose a setting in a range of 0–7. Although the result will depend on the type of sample, higher settings generally produce better results, but will take longer to execute.

Since you can try this command as many times as you like, start with a value of about 4, and raise it little by little if necessary.

- 6. Press the **OK** button to execute the **Time Stretch** command, or press the **Cancel** button to cancel.

Note: When you execute this command, new regions and WAVE files will be created, and file names and region names will be assigned automatically. The audio events will also be modified. Automation data will not be affected.

Step Recording (Loop Type)

Here you can perform step recording into a pattern.

This is available when a user pattern is selected.

1. In Pattern and Pattern Select, specify the pattern.

By default, the pattern length is one measure. If you wish to change the number of measures in the pattern, set the “Pattern Parameter.”

2. Select “Step Recording (Loop Type)” to open the dialog box.

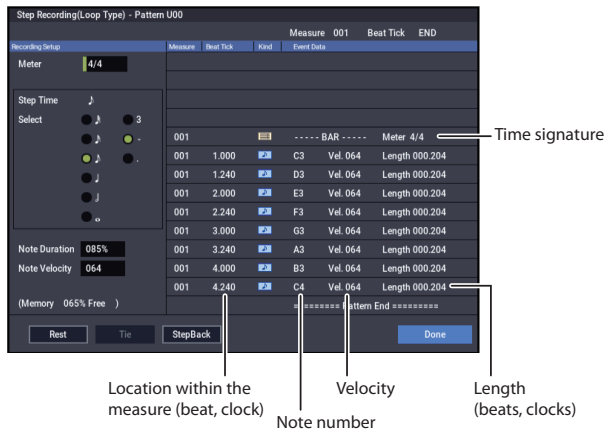

3. The remaining steps are the same as when step recording on a track.

Refer to steps 3 and following in the “MIDI Step Recording” menu command. However, step recording a pattern differs from step recording a track in that when you reach the end of the pattern, you will return to the beginning and continue recording, in this way continuing to add more data.

Event Edit

Here you can edit individual events of the musical data in a pattern.

Use **Pattern** and **Pattern Select** to specify the pattern, and then select this command.

The remaining steps are the same as when editing a MIDI track using track event editing. See “MIDI Event Edit.”

Pattern Parameter

This command specifies the number of measures and the time signature of the selected pattern.

1. Use **Pattern** and **Pattern Select** to specify the pattern.
2. Select “Pattern Parameter” to open the dialog box.



3. In Length, specify the number of measures in the pattern.

4. In Meter, specify the time signature of the pattern.

However, this time signature is only temporary, and when you “put” or “copy” the pattern in a track of a song, the

pattern will play according to the time signature of that measure.

5. To execute the **Pattern Parameter** settings, press the **OK** button. To cancel, press the **Cancel** button.

Erase Pattern

This command erases the data from the selected pattern.

1. Use **Pattern** and **Pattern Select** to specify the pattern.
2. Select “Erase Pattern” to open the dialog box.

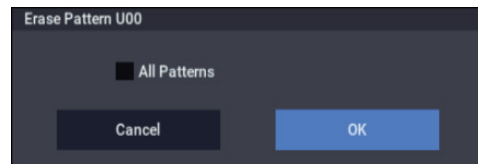

3. If you check “All Patterns,” all user patterns in the song will be erased.

If “All Patterns” is not checked, only the pattern specified in step 1 will be erased.

4. To execute the **Erase Pattern** command, press the **OK** button. To cancel, press the **Cancel** button.

Copy Pattern

This command copies the settings and musical data of the selected pattern to another pattern.

User patterns belong to a particular song, but you can use the Copy Pattern command to use the same pattern in another song.

Also, while preset patterns cannot be edited, you can copy a preset pattern to a user pattern and then edit and save it as a user pattern. Be aware that when you execute the Copy Pattern operation, the pattern settings and musical data of the copy destination will be erased.

1. Select “Copy Pattern” to open the dialog box.

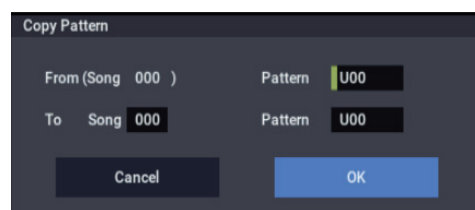

2. In From (Song**): Pattern, specify the copy source pattern.

(By default, this will be the song and pattern that was selected in the Pattern Edit page.)

3. In To: Song and Pattern, specify the copy destination song and pattern.

For **Pattern**, only user patterns U00–U99 can be specified.

4. To execute the **Copy Pattern** command, press the **OK** button. To cancel, press the **Cancel** button.

Bounce Pattern

This command combines the musical data of the bounce source pattern and bounce destination pattern, and places the combined musical data in the bounce destination. The time signature and length of the pattern following execution will be according to the settings of the bounce destination. Unlike the Track Bounce operation, the musical data of the bounce source will not be erased.

If MIDI control data exists in the selected pattern and in the bounce destination pattern, the resulting playback following the bounce operation may produce unexpected results. We recommend that you use the “MIDI Event Edit” command to prepare the MIDI control data of the two patterns before executing the Bounce Pattern command.

1. Use **Pattern and Pattern Select** to specify the bounce source pattern.
2. Select **“Bounce Pattern”** to open the dialog box.

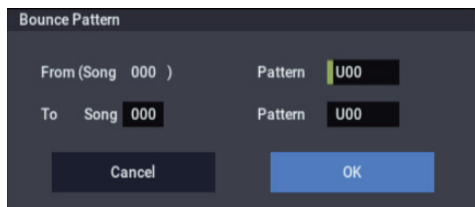

3. In **From (Song***)** Pattern, select the bounce source pattern.
(By default, the song and pattern that are selected in the Pattern Edit page will be chosen.)
4. In **To: Song and Pattern**, select the bounce destination song and pattern.
For **Pattern**, only user patterns U00–U99 can be specified.
5. To execute the **Bounce Pattern** command, press the **OK** button. To cancel, press the **Cancel** button.

Get From MIDI Track

This command takes musical data from a MIDI track and loads it into the specified pattern.

1. Use **Pattern and Pattern Select** to specify the pattern.
2. In the **“Pattern Parameter”** menu command, specify the pattern length of the “get” destination.
3. Select **“Get From MIDI Track”** to open the dialog box.

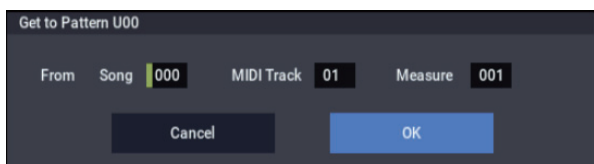

4. In **Song**, select the “get” source song.
5. In **Track**, select the “get” source MIDI track.
6. In **Measure**, specify the first measure of the “get” source.
7. To execute the **Get From MIDI Track** command, press the **OK** button. To cancel, press the **Cancel** button.

Put To MIDI Track

This command places a pattern into a MIDI track.

Unlike the “Copy To MIDI Track” menu command, this command only places the pattern number in the song, so that when playback reaches that point, the pattern will be recalled. The musical data of the pattern will not actually exist in the track.

By creating patterns that contain frequently-used phrases or drum patterns, and then placing them on the tracks, you can conserve memory.

Be aware that when you edit a pattern, all locations in the song where that pattern has been placed will be affected.

When you execute the Put To MIDI Track command, the musical data will be affected as follows.

- Musical data previously existing at the “put” destination will be erased.
- The pattern that you “put” will playback according to the time signature that is specified by the measures of the “put” destination.
- Control data such as pitch bend etc. (but not including volume data) previously existing in the track will be reset immediately before the measure at which the pattern was “put.”

If you wish to use control data such as pitch bend in the measures in which a pattern is “put,” you must first write the control data into the pattern.

To delete a pattern that has been placed in a track you can use the “Erase Measure” menu command, specifying the area in which the pattern was “put,” and setting “Kind” to All.

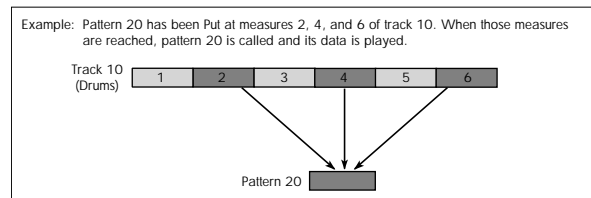

1. Select **“Put To MIDI Track”** to open the dialog box.

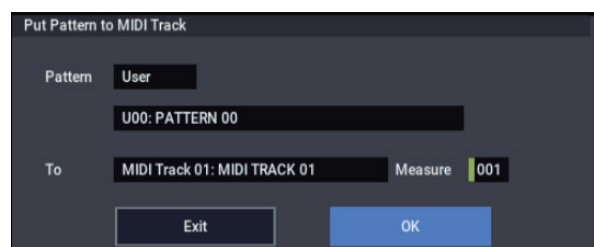

2. In **Pattern and Pattern Select**, select the “put” source pattern.
(By default, this will be the pattern selected in the Pattern Edit page)
- In **To: Track**, select the “put” destination MIDI track.
3. In **Measure**, specify the first measure of the “put” destination.
4. To execute the **Put To MIDI Track** command, press the **OK** button. When you execute the command, **Measure** will automatically count up.

If you wish to, you can continue “putting” the pattern. To exit the command, press the **Exit** button.

Copy To MIDI Track

This command copies the specified area of musical data from the specified pattern to a MIDI track as musical data.

Unlike the Put To MIDI Track command, this command actually writes the musical data of the pattern into the MIDI track, so that you can edit the copied data in the track. Even if you later edit the copy source pattern, the musical data of the song will not be affected.

When you execute the Copy To MIDI Track command, the musical data will be affected as follows.

- Musical data previously existing in the copy destination measures will be erased.
- The musical data that is copied will playback according to the time signature specified at the copy destination measures.

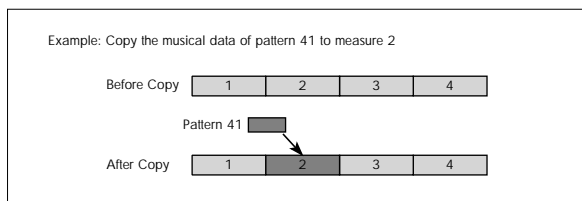

The procedure is the same as for the Put To MIDI Track command. For more information, see “Put To MIDI Track” on page 552.

Convert to Drum Track Pattern

This command converts a user pattern into a user Drum Track pattern, which can then be used with the Drum Track in any mode. The converted Drum Track pattern will be preserved in the NAUTILUS’s memory even when the power is turned off, so you can manage it together with the Programs and Combinations.

1. Use **Pattern** and **Pattern Select** to select the pattern you’d like to convert.
2. Select the **Convert to Drum Track Pattern** menu command to open the dialog box.

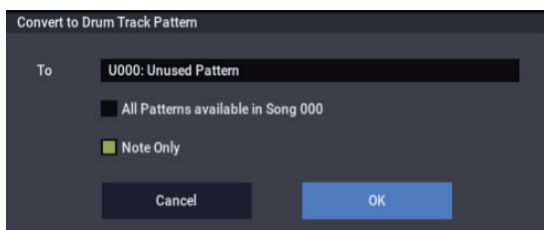

3. Use the **To Drum Track Pattern Select** field to specify the destination User Drum Track pattern.

Note that, when the command is executed, any data in this pattern will be overwritten.

4. If you check the **All Patterns available in Song ***** item, all patterns in the song that contain note events will be copied, starting at the number you specified in step 3.
5. If you execute with **Note Only** checked, only the note events will be copied.
6. Press the **OK** button to execute **Convert To Drum Track Pattern**, or press the **Cancel** button if you decide not to continue.

⚠ If there isn’t enough drum pattern memory, or if there aren’t enough pattern locations, an error message of “Not enough Drum Track pattern memory” or “Not enough Drum Track pattern locations available” will appear, and the command cannot be executed.

Tip: It’s a good idea to convert drum patterns that you use frequently. Use **Load Drum Track Pattern** to load them.

Load Drum Track Pattern

This command loads a user drum track pattern into a user pattern.

If you want to edit a user drum track pattern, you must first load it into a Song pattern. Once it’s in a pattern, you can edit it. After editing, you can use **Convert to Drum Track Pattern** to save it as a user drum track pattern.

1. Select **Load Drum Track Pattern** to open the dialog box.

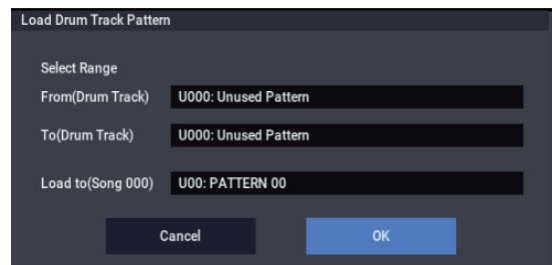

2. Use **Select Range From (Drum Track)** and **To (Drum Track)** to specify the copy-source user drum track pattern.

The user drum track patterns between **From** and **To** will be loaded. If you want to load only one pattern, set **From** and **To** to the same number.

When you execute this command, the data will be overwritten onto the copy-destination number.

3. Use **Load to (Song ***)** to specify the load-destination user pattern number.
4. Press the **OK** button to execute the **Load Drum Track Pattern** command, or press the **Cancel** button if you decide not to execute.

Erase Drum Track Pattern

Erase Drum Track Pattern is available on the **Pattern Edit** and **Pattern Name** tabs of the **Pattern/RPPR** page, as well as the **Drum Track** page.

This erases the specified drum track pattern.

1. Select “**Erase Drum Track Pattern**” to open the dialog box.

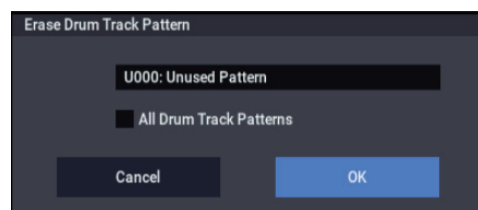

2. Select the user drum track pattern you want to erase.
3. If you check **All Drum Track Patterns**, all user drum track patterns will be erased.

- To execute the Erase Drum Track Pattern command, press the OK button. To cancel, press the Cancel button.

Copy External Scene

Please see “Copy External Scene” on page 122.

Copy Scene

Please see “Copy Scene” on page 122.

Swap Scene

Please see “Swap Scene” on page 122.

Copy Insert Effect

Please see “Copy Insert Effect” on page 122.

Note: The slot’s MIDI control channel, as specified by the Ch parameter on the IFX1–12 pages, will not be copied.

Swap Insert Effect

Please see “Swap Insert Effect” on page 123.

Note: The slot’s MIDI control channel, as specified by the Ch parameter on the IFX1–12 pages, will not be swapped.

Insert IFX Slot

Please see “Insert IFX Slot” on page 123.

Cut IFX Slot

Please see “Cut IFX Slot” on page 124.

Clean Up IFX Routings

Please see “Clean Up IFX Routings” on page 124.

DrumKit IFX Patch

Please see “Drum Kit IFX Patch” on page 438.

Copy MFX/TFX

Please see “Copy MFX/TFX” on page 125.

Note: The slot’s MIDI control channel, as specified by the Ch parameter on the MFX1–2 pages, will not be copied.

Swap MFX/TFX

Please see “Swap MFX/TFX” on page 125.

Note: The slot’s MIDI control channel, as specified by the Ch parameter on the MFX1–2 pages, will not be swapped.

Write FX Preset

Please see “Write FX Preset” on page 126.

Put Effect Setting to Track

This inserts effect settings into a track as System Exclusive events. Use this when you want to change the effect settings during a song.

- If you use MIDI parameter change system exclusive messages to change the effect settings, it will take a certain amount of time for the effect change to occur. In addition, the sound may not change smoothly if sound is being produced at that time. Be aware of the timing of your playback data, and make the appropriate adjustments to the location at which the system exclusive message is inserted.

Note: If you switch effects during the song, you should also insert this command at the beginning of the track (Measure 001, Beat.Tick 01.000) as well, so that the song starts with the correct effect.

- Use IFX page, or MFX/TFX page to edit the effect you want to insert (IFX1–12, MFX1, 2, TFX 1, 2), and determine the song, track, measure, beat, and clock at which you should insert the System Exclusive event. For example, let’s suppose that IFX6 which is used on track 3 needs to change at the beginning of measure 9.



- Select Put Effect Setting to Track to open the dialog box. (The values shown in the dialog box are the settings for example (1).)

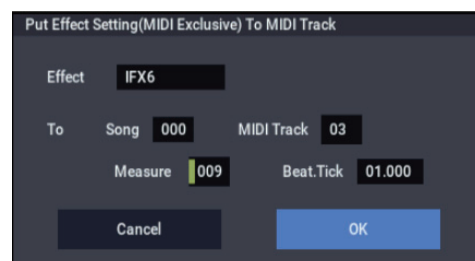

- Use Effect to select the effect that you want to insert.
- Use To: Song to specify the song, Track to specify the track, Measure to specify the measure, and Beat.Tick to specify the beat and clock at which you want to insert the event.
- Press the OK button to execute the Put Effect Setting to Track command. If you decide to cancel, press the Cancel button.

- The inserted event contains only the type of effect and the effect parameters. You’ll need to realtime-record the effect on/off status and the bus, etc.

Note: Return the location to a point earlier in the song, and play back to verify that the effect changes as you intend. You can also use the Track Edit page menu command “MIDI Event Edit” to verify that a parameter change system exclusive message (Exclusive) has been inserted.

Note: If a pattern has been inserted at the insert-destination, that pattern will be expanded into note data.

Using “Put Effect Setting to Track” to switch effects

The “Put Effect Setting to Track” page menu command inserts effect settings into a track as exclusive event data.

In this example, we’ll apply IFX3 to MIDI track 2, and make the effect 051: Stereo Phaser change to 048: Stereo Flanger in the middle of the song. We’ll describe two ways of doing this; 1) and 2).

In order to perform this example, begin by making the following settings.

- In the Home– Mixer page, use “Program Select” to choose the desired program for MIDI track 02.
- In the MIDI Routing 1 page, route MIDI track 02 “IFX/Indiv. Out Assign” to IFX3. Then in the IFX– Insert Effect page, choose 051: Stereo Phaser for IFX3.

 If you use MIDI parameter change system exclusive messages to modify effect settings, it will take a certain amount of time for the effect change to occur. If notes are sounding, there may be cases in which the sound does not change smoothly. Consider the timing of the performance data, and insert the system exclusive message at a location that will cause minimal disruption to the sound.

 You can only insert events to specify the type of effect and the effect parameters. Settings for effect on/off and bus selection must be recorded in realtime.

1) Inserting effect settings at the beginning and in the middle of the song

In this example we’ll use the page menu command “Put Effect Setting to Track” to insert MIDI parameter change system exclusive messages into MIDI track 3 so that the insert effect (IFX3) uses 051: Stereo Phaser for measures 1 through 8, and 048: Stereo Flanger for measures 9 and following.

1. Select the desired program for MIDI track 2, and send it to IFX3.

Make the following settings for MIDI track 2.

Track Select: MIDI Track 02 (Home– Mixer page)

Bus Select (IFX/Indiv. Out Assign): IFX3 (IFX– MIDI Routing1 page)

Use the Home– Mixer page to assign the desired program to track 2, and use the IFX– Insert Effect page to route the effect to track 3 and make effect settings.



2. Set Track Select to MIDI Track 03, and specify the desired routing.

3. In IFX– Insert Effect, choose the “Put Effect Setting to Track” page menu command to open the dialog box.

4. Specify the effect and insertion location for the exclusive message you want to insert.

Effect: IFX3
To: Song: 000
Track: 03
Measure: 001
Beat.Tick: 01.000

5. Press the OK button.

6. Specify the effect that you want to use for measure 9 and following.

Go to the IFX– Insert FX page, and choose 048: Stereo Flanger for IFX3.

7. In the IFX– IFX 1-12–IFX3 page, set the parameters as desired.

8. In the IFX– Insert FX page, choose the “Put Effect Setting to Track” page menu command to open the dialog box.

9. Specify the effect and insertion location for the exclusive message you want to insert.

Effect: IFX3
To: Song: 000
Track: 03
Measure: 009
Beat.Tick: 01.000

10. Press the OK button.

When you play back after executing these commands, the effect on track 3 will change to 048: Stereo Flanger at measure 9.

11. If you select the page menu command “Compare” (it will light) and play back, the playback will occur as it did before you executed “Put Effect Setting to Track.”

You can use the COMPARE button to compare the state of the track before and after execution.

12. In the Track Edit page, set Track Select to Track 03, and choose the “MIDI Event Edit” page menu command to access the event edit screen. (In the Set Event Filters dialog box, check “Exclusive.”)

Notice that a MIDI parameter change system exclusive message is inserted at the beginning and at measure 9 of track 3.

2) Using the song's own effect settings from the beginning of the song, and inserting effect settings from elsewhere into the middle of the song

In this example, we'll apply an insert effect (IFX3) to MIDI track 3, and make settings so that it uses 051: Stereo Phaser from the beginning of the song. At measure 9, we'll insert a MIDI parameter change system exclusive message to make IFX3 switch to the 048: Stereo Flanger effect settings that were created for a different song.

1. Select a desired program for MIDI track 3, and send it to IFX3.

Make the following settings for MIDI track 3.

Track Select: MIDI Track 03 (Home– Mixer page)

Bus Select (IFX/Indiv.Out Assign): IFX3 (IFX– MIDI Routing1 page)

In the Home– Mixer page, assign a program to track 3. Then use the IFX– Insert Effect page to route track 3 to the effect, and make effect settings.

2. Use Track Select to select MIDI Track 03, and record on it.

3. On a separate song you copied, make the effect settings that you want start using at measure 9.

1) Create song S001.

2) Use the “Copy From Song” page menu command to copy from Song 000 to Song 001.

4. In song 001, make the effect settings that you want to use from measure 9. Go to the IFX– Insert FX page, and choose 048: Stereo Flanger for IFX3.

5. In the IFX– Insert FX– IFX3 page, set the parameters as desired.

6. Choose “Put Effect Setting to Track” to open the dialog box.

7. Insert the effect settings you created in song 001 into song 000.

Effect: IFX3

To: Song: 000

Track: 03

Measure: 009

Beat.Tick: 01.000

8. Press the OK button to execute the command.

After execution, select song 000 and play it back. The effect for track 3 will change to 048: Stereo Flanger at measure 9.

9. In song 000, you can select the page menu command “Compare” (it will light) and play back to hear the song as it was before you executed “Put Effect Setting to Track.”

You can use the **Compare** to compare the state of the track before and after execution.

Note: In the Track Edit page of song 000, set **Track Select** to Track 03 and choose the “MIDI Event Edit” page menu command to access the Event Edit screen. (In the Set Event Filters dialog box, check “Exclusive.”)

Notice that a MIDI parameter change system exclusive message is inserted at measure 9 of track 3.

System Exclusive events supported in Sequencer mode

You can record and play back System Exclusive events, and edit tracks that contain System Exclusive events.

SysEx messages that can be recorded in real-time

The following exclusive messages can be recorded in real-time:

- Exclusive messages received from an external MIDI device
- Parameter changes in SEQUENCER mode (see table below)
- Master Volume universal exclusive messages assigned to the foot pedal or a RT control knob

Parameter change messages that you can realtime-record in SEQUENCER mode

| Front panel/Page | | Parameter |
|--|------------------------|--|
| Front panel | ARP/DRUM | ARP, LATCH, DRUM buttons, RT Knob([Gate], [Velocity], [Length], [Swing], [Drum SD]) |
| Home | MIDI Prog Mixer | Program Select, Pan, Volume, PLAY/MUTE, Solo On/Off *1 |
| | Audio Track Mixer | Rec Source, Pan, Volume, PLAY/MUTE, Solo On/Off *1 |
| | Audio In Sampling | All "Audio Input" parameters |
| EQ/X-Y/ Controllers- Controllers | MIDI Track EQ | Auto Load Prog EQ, Bypass, Input Trim, High Gain, Mid Frequency, Mid Gain, Low Gain |
| | Audio Track EQ | Bypass, Input Trim, High Gain, Mid Frequency, Mid Gain, Low Gain |
| | X-Y Volume | All "X-Y Volume Control" parameters, X-Y Assign, Center Volume, Enable Program X-Y Volume |
| | X-Y CC | All "X-Y CC Control" parameters, Enable Song X-Y CC, Enable Program X-Y CC |
| | X-Y Envelope | All "Basic," "X-Y Envelope Loop," "X-Y Envelope" parameters |
| | Set Up Controllers | All "Panel Switch Assign," "Modulation Knob Assign" parameters |
| | Pads | All "Pad Chord" parameters except "Enable Pad Play" and "Chord Assign On/Off" |
| Track Parameters | MIDI | Track Priority |
| | OSC | Force OSC Mode, OSC Select, Portamento |
| | Pitch | Transpose, Detune, Bend Range, Use Program's Scale, Type, Key, Random |
| | Delay | Mode, Time, Base Note, Times |
| | WaveSeq ARP | Key Sync, Swing, Quantize Trigger, ARP Track On/Off Control |
| | Audio Track Delay | Mode, Time, Base Note, Times |
| IFX | MIDI/Audio Routing 1/2 | "Bus Select, Send1, Send2, Fx Control Bus, Rec Bus |
| | Insert FX | IFX, IFX On/Off, Chain to, Chain, Pan, Bus Sel, REC Bus, Ctrl Bus, Send1, Send2 |
| | IFX 1-12 | All effect parameters |
| | Common FX LFO | All "Common FX LFO 1, 2" parameters |
| MFX/TFX | Routing | MFX, MFX On/Off, Chain, Chain Direction, Chain Level, Return 1, Return 2, TFX, TFX On/Off, Master Volume |
| | MFX 1/2 | All effect parameters |
| | TFX 1/2 | All effect parameters |

*1: **Solo On/Off** is always controlled by events in the track, regardless of the play/mute status of that track.

 The maximum amount of exclusive data that can be recorded at once is approximately 320 Kbytes. This size will decrease if other events exist within the same measure.

 You cannot simultaneously record exclusive messages received from an external MIDI device and parameter changes produced by editing.

 If you record a parameter assigned to a control change such as **Pan** with the GLOBAL mode GLOBAL > MIDI- MIDI Filter settings "Enable Control Change" and "Enable Exclusive" both checked, edits you make during recording will be recorded both as control change data and parameter change data. These recorded events may not be reproduced correctly if you rewind or fast-forward during playback. If you want to record such events, check only one of these two "Enable" settings in GLOBAL mode MIDI Filter.

SET LIST mode

Overview

Set Lists make it simple to play and organize any of the sounds loaded into the NAUTILUS, without regard for what bank they're stored in or whether they're Programs, Combinations, or even Songs.

Large on-screen buttons with selectable colors make sound selection fast and foolproof, and the Program Up or Down footswitch assignments can be used for hands-free sound changes. Cut, copy, paste, and insert tools make re-ordering a snap.

Smooth Sound Transitions let the previous sound and its effects ring out naturally, making it easy to change sounds during a live performance. Set Lists give you greater control over these transitions, in comparison to the other modes. You can fine-tune the ring-out time for each sound, so that (for instance) one sound fades out very quickly, while another sound's delays continue to repeat for ten or twenty seconds.

Long comments let you store lyrics or performance notes with the sound.

Set Lists are great for live performance, but they're also handy for organizing sounds in general. For example, you could create a Set List with all of your favorite String sounds, including both Programs and Combinations.

SET LIST > Home

0-1: Play

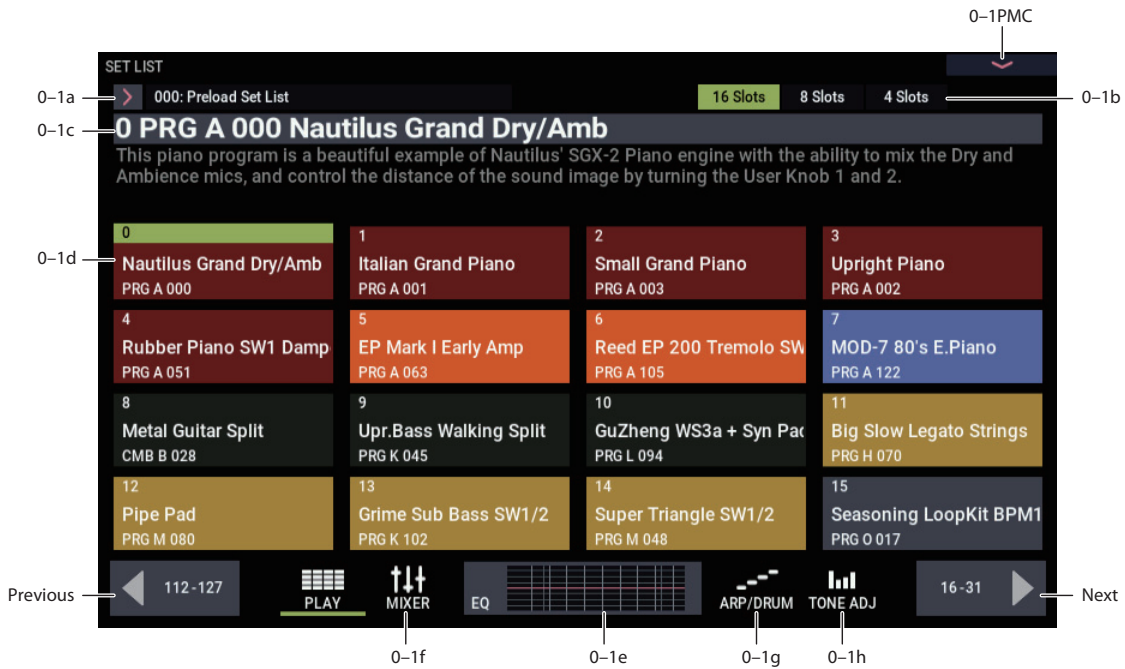

Overview

A Set List has 128 Slots, each of which can be assigned to any Program, Combination, or Song. You can have 128 Set Lists in memory at once.

The large name in the Set List display is the name of the current Slot, so that you can easily see the sound that you're playing. The Set List name is in smaller text at the top left-hand corner of the screen.

For more information on using Set Lists, see "Set Lists" on page 113 of the OG.

On this page, you can:

- Select the current Set List
- Select Slots within the Set List (Programs, Combis, Songs).
- View the comments for the selected Slot (including the large Comment Pad)
- View the current EQ curve, and jump quickly to the EQ controls.



Line 1: This is the slot number used for "Slot No.". The currently selected slot is displayed with a green stripe. The figure above shows that Slot 0 is selected.

Line 2: The sound registered to the slot, or the name for that slot (Slot Name → 1-1a (link)) is displayed. Slot names that are set for slots will be displayed first, if they exist.

Line 3 (left): Shows the mode, bank and number of the sound registered to the slot. (Abbreviations used: Program=PRG, Combination=CMB, Song=SNG)

In the example above, the sound for program number A000 in PROGRAM mode is registered to slot 0.

Line 3 (right): If Transpose is set for the slot, transpose information (± 12) is shown.

In the figure above, the transpose setting for slot 8 is "-12".

0-1a: Set List Select

Set List Select [000...127]

This is the Set List, which contains the Slots.

When the Set List Select window is open, you can use the Find button to search for Set Lists by name. For more information, see "Find dialog" on page 7.

0-1b: 4/8/16 Slots

These buttons select how many Slots are shown at once. Smaller numbers of Slots leave more room to show the Comments; larger numbers let you select between more Slots without switching screens. You can change between these settings at any time, as convenient.

Set List Select menu

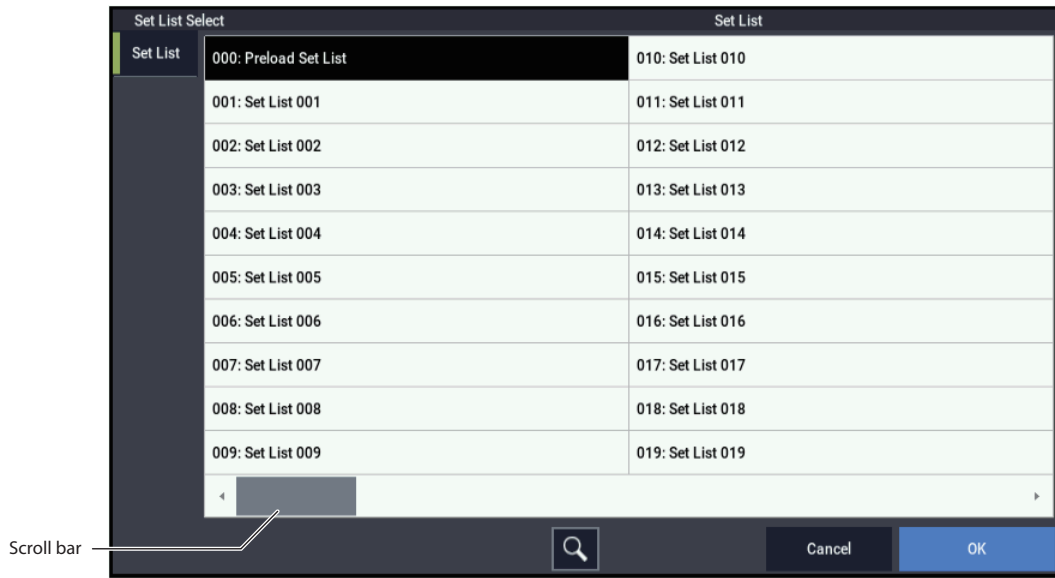

0-1c: Slot information

This section shows information for the selected Slot. The number, Slot name, and Program, Combination, or Song name are shown in large text. The comment is shown in the area below. Use the scroll bar on the right to view longer comments, or touch the comment area and drag down to reveal the Comment Pad, as described below.

Comment Pad

The Comment Pad devotes the entire screen to the comment text—convenient for viewing lyrics or longer notes, especially with larger font sizes.

To show the Comment Pad, touch the comment area and drag down. (When you touch the comment area, a downward arrow appears on the screen to hint at this functionality.)

To close the Comment Pad, press the EXIT button or touch the large “X” in the upper right corner of the window.

To adjust the brightness of the text, use the three icons in the upper left corner of the window.

To adjust the size of the font, use the S/M/L/XL, Font Size buttons at the bottom of the Window. This mirrors the Slot’s Font parameter.

To edit the comment, press the Edit Comment button at the bottom of the window. For more information, see “Comment” on page 566.

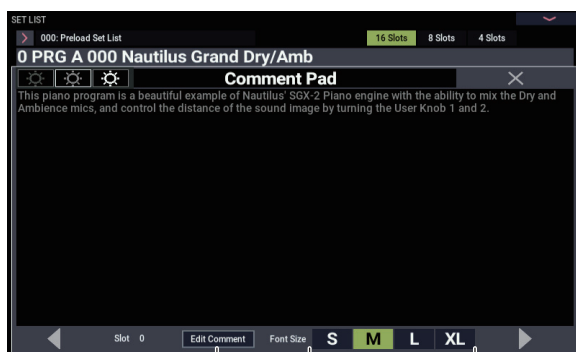

0-1d: Slot Select

Slot Select [000...127]

The 128 Slots are shown either 4, 8, or 16 at a time, depending on the selection of the 16/8/4 Slots button (0-1b). To select a slot, simply touch it. (You can also use other methods, as described below.) To move to another group of Slots, use the Previous and Next buttons at the bottom of the display.

Selecting Slots

Selecting within the current group of Slots

To select one of the Slots shown on the display:

1. Press the desired button.

The button becomes highlighted, and the comments and large slot number/name at the top of the screen are updated accordingly.

Selecting outside the current group of Slots

To select a Slot which is not shown on the display:

1. Use the next and previous arrow-buttons at the bottom of the screen to browse through the groups of Slots.

The labels for next/previous will vary depending on the current group of Slots, and on the number of Slots being shown. For instance, if 16 Slots are being shown and the current group is 0-15, the buttons will show 112-127 and 16-31, respectively.

As you browse, the current selection does not change until you actually press one of the Slot buttons.

2. When the desired group of Slots is displayed, press the button for the desired slot.

The button becomes highlighted, and the comments and large slot number/name at the top of the screen are updated accordingly.

Selecting using data entry controls

In addition to using the touch-screen buttons, you can select Set List and Slots using the standard data entry controls, including the VALUE dial, and +/- buttons.

Next/Previous buttons wrap

The next and previous buttons wrap within the current Set List. For instance, if you're currently looking at Slots 0-15 of Set List 003, and you press the 112-127 button, the screen changes to show Slots 112-127, still in Set List 003.

+/- and Program Up/Down, when selection is off-screen

The +/- buttons and the Program Up/Down footswitches operate on the current selection, regardless of which group of Slots is currently shown. For instance, assuming that the display is showing 16 Slots, and you're currently viewing Slots 0-15:

1. Select Slot 3.
2. Use the "next" button to show Slots 16-31.
3. Press the + button, or a footswitch assigned to Program Up.

Slot 4 is selected, and the display returns to Slots 0-15.

Next/Previous Slot selection

In addition to selecting Slots via the on-screen buttons, you can use +/- buttons or a footswitch assigned to Program Up or Program Down to step through sounds.

Selecting with +/- buttons

1. Touch one of the on-screen Slot buttons.

Once a Slot is selected, you can use the + and - buttons to step through the list of sounds.

If you're on the last button on the current page, pressing + button will advance you to the first button of the next group of Slots.

Program Up/Down footswitch

The Program Up and Program Down footswitches always step through the list, regardless of whether or not one of the buttons has the UI focus.

The footswitch can be assigned to Program Up or Program Down on the GLOBAL mode Controllers page.

Wrapping between Set Lists

+/- buttons and Program Up/Down wrap between Set Lists. For instance:

1. Select Slot 127 in Set List 5.
2. Press Inc, or the Program Up footswitch.

Slot 0 of Set List 6 is selected.

Similarly:

1. Select Slot 0 in Set List 5.
2. Press Dec, or the Program Down footswitch.

Slot 127 of Set List 4 is selected.

If you've edited any Slots in the Set List, a dialog will appear prompting you to save your changes before proceeding. For more information, see "Save Changes before changing Set List: a confirmation dialog" on page 564.

Wrapping between Set List 0 and Set List 127

+/- buttons and Program Up/Down wrap between Set Lists 0 and 127. For instance:

1. Select Slot 127 in Set List 127.
2. Press +, or the Program Up footswitch.

Slot 0 of Set List 0 is selected.

Similarly:

1. Select Slot 0 in Set List 0.
2. Press -, or the Program Down footswitch.

Slot 127 of Set List 127 is selected.

Programs wrap in a similar fashion, between A 000 and T 127.

Selection via MIDI

MIDI In

Program Change messages on the Global Channel select the Slot, and Bank Select messages on the Global Channel select the Set List.

When a Slot is selected via MIDI, the display updates if necessary to show the appropriate group of Slots.

MIDI Out

Selecting a Slot sends Program Change and Bank Select messages, as above.

When selected, Combinations and Songs can transmit other Program Change and Bank Select messages on other channels, as they do in COMBINATION and SEQUENCER modes.

Bank Map

The GLOBAL > Basic Setup- **Bank Map** (KORG, GM(2)) parameter does not affect the reception or transmission of Set List Program and Bank Select messages.

Editing the selected Program, Combination, or Sequence

When you're in a rehearsal or sound-check, you may need to make quick edits to a sound in the Set List.

With this in mind, you can:

- Jump to the editing pages for the selected Program, Combination, or Song
- Make the desired edits
- Save the edits
- Return easily to the original Set List page

For more information, see "Edit Program/Combination/Song" on page 569.

Continuous playback with Songs

Two or more slots can be set to the same Song, but with different Keyboard Tracks. You can switch between such Slots, changing the sound assigned to the keyboard, as the song continues to play.

0-1e: GRAPHIC EQ

The graphic at the bottom of the page shows the frequency curve created by the Set List EQ, along with whether or not the EQ is bypassed. Touch the graphic to jump directly to the Set List GRAPHIC EQ dialog.

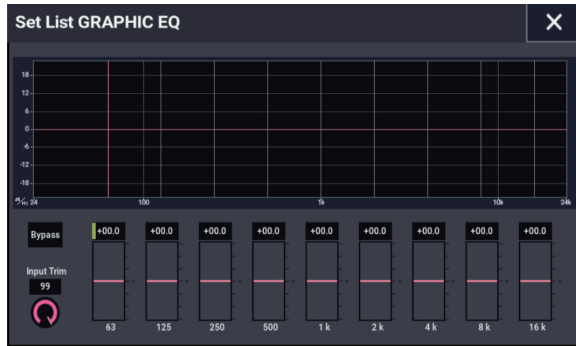

0-1f: MIXER

The mixer is used to adjust the balance between sounds of the Set List Slot in use.

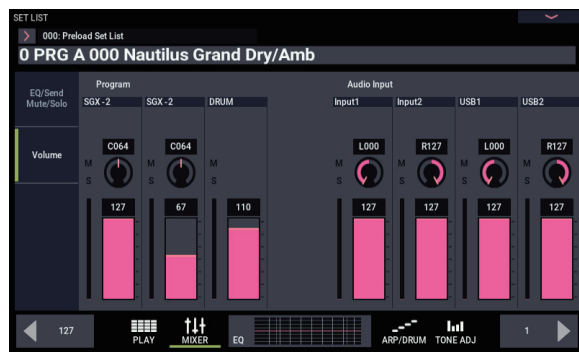

Volume

When the sound of the selected slot is a Program

The OSC (EXi) of the selected Program, the drum track balance and audio input settings are shown.

The mixer is used to adjust the balance between sounds of the Set List Slot in use.

EQ/Send/Mute/Solo

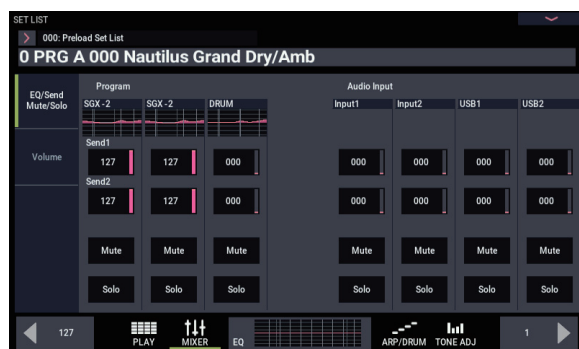

Program

EQ: Displays the OSC (EXi) and drum track EQ. Press this to display a larger screen for making adjustments.

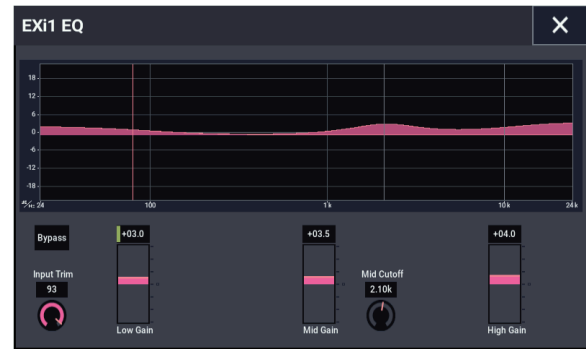

Note: The EQ shown in OSC (EXi) is a 3-band EQ for the Program, and has the same parameters as 1 and 2 (EXi1,2). You can adjust the 3-band EQ that is exclusively used by the drum track.

Note: There is no EQ for the audio input.

Send: Adjusts the send levels for the OSC (EXi), drum track and audio input. When using an IFX such as OSC (EXi) for the Program, this adjusts the send level for the IFX.

Mute, Solo: Controls the mute and solo status for the OSC (EXi), drum track and audio input.

Audio Input

Adjusts the audio input.

When the sound of the selected slot is a Combination or Song

This is basically the same as the Mixer features in COMBINATION > Home and in SEQUENCER > Home.

Use the Edit Combination (Song) command (→PMC) when changing the Timbre (Track) Program inside of a set list.

EQ: This lets you view and adjust the timbre (track) EQ.

0-1g: ARP/DRUM

This turns the arpeggiator and/or drum track/step sequence for the selected Program or Combination on and off.

This works the same as the ARP DRUM page for each mode.

For more information, see “ARP DRUM page” p.15, p.390, p.460.

Note: You cannot change the scene settings from this page.

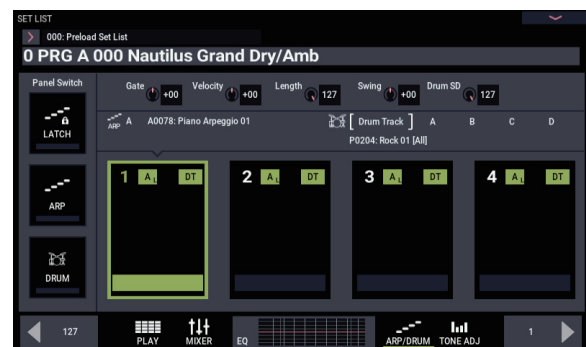

0-1h: TONE ADJ

Here you can change the Tone Adjust settings for the selected Program, Combination or song.

This works the same as the Tone Adjust page for each mode.

For more information, see “Tone Adjust page” p.29, p.394, p.464.

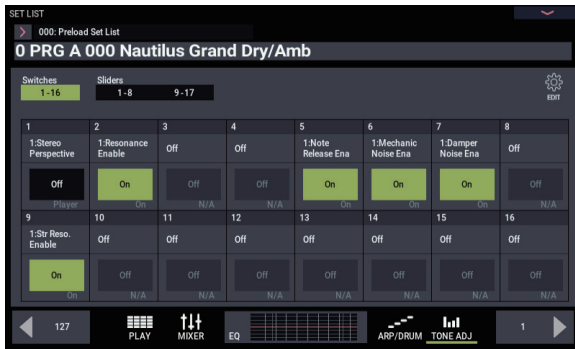

✓ 0-1: Page Menu Commands

- Compare →p.112
- Write Set List →p.569
- Exclusive Solo →p.113
- Initialize Set List →p.569
- Edit Program/Combination/Song →p.569
- Update Program/Combination →p.569
- PAGE →p.126
- MODE →p.126

Save Changes before changing Set List: a confirmation dialog

If you have edited a Set List, and then do something that would select a different Set List (including directly changing the Set List, or wrapping between Set Lists by changing the Slot), a confirmation dialog will appear. The dialog offers the option of saving or discarding the edits.

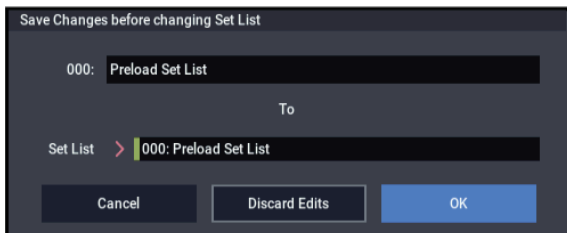

Saving your edits

If you want to save your edits:

1. Use the Set List to set the name, as desired.

If a USB QWERTY keyboard (commercially available) is connected, you can use this to enter text instead of the on-screen keyboard.

2. Select the location to save to using the To Set List parameter.
3. Press the OK button to save the changes.

The changes will be saved to the specified location, and the Set List change will proceed.

Discarding edits

If you do not want to save your edits, and just want to proceed to the new Set List:

1. Press the Discard Edits button.

Canceling the Set List change

If you want to review your edits, and not proceed to the new Set List:

1. Press the Cancel button.

SET LIST > Edit

1-1: Edit



On this page, you can:

- Edit the individual Slots in the list, including their Program/Combination/Song assignment, comment text and font size, (such as lyrics or performance notes), name, color, volume, hold time, transposition, keyboard track (for Songs), On/Off and value of DYNAMICS button.
- Change the order of items in the list, using the Cut, Copy, Paste, and Insert buttons.

The group of Slots shown here are the same as shown on the Select page. Changing the group in one page changes it in the other.

0-1a: Set List Select

Set List Select [000...127]
This is the Set List, which contains the Slots.

0-1b: 4/8/16 Slots

These buttons select how many Slots are shown at once. Smaller numbers of Slots leave more room to show the Comments; larger numbers let you select between more Slots without switching screens. You can change between these settings at any time, as convenient.

0-1c: Slot number and name

This section shows information for the selected Slot, including the number, Slot name, and Program, Combination, or Song name. To select the Slot, use the buttons below.

1-1a: Slot parameters

(Item Type) [Program, Combination, Song]
Each slot can hold either a Program, a Combination, or a Song.

Program/Combination/Song Select [List]
This shows the bank, number, and name of the Slot's Program or Combination, or the number and name of the Slot's Song (Songs don't have banks).

Pressing the button brings up a popup menu which you can use to select Programs, Combinations, or Songs, depending on the **Type** setting.

Note that you can use the same sound in multiple Slots within the same Set List. This can be convenient, for instance, for live performance when using a foot switch to automatically advance from Slot to Slot.

For more information on selecting by bank and number, see "Program Select" on page 3, "Combination Select" on page 377, and "Song Select" on page 445.

Category [List]
This button shows the Category of the Slot's Program or Combination. If the current Slot is a Song, this does not appear.

Pressing the button brings up a popup menu which you can use to select Programs or Combinations, as an alternative to selecting by bank and number.

For more information on using Categories, see "Main Category" on page 3 and "Combination Select" on page 377.

Keyboard Track [1...16]

For songs, you can assign the local keyboard to play any of the 16 MIDI tracks. If you like, you can have the same Song in multiple Slots, each with a different Keyboard Track. You can then switch between the Slots, changing the sound assigned to the keyboard, as the Song continues to play.

This parameter applies to Songs only. If the current Slot is a Program or Combination, it does not appear.

Slot Name [24 characters]

You can name the Slot separately from the name of the Program, Combination, or Song it contains. For instance, if you're creating a Set List for a gig, you can name the Slots after the section of music in which they're used, such as "Montana Intro."

Pressing the slot name brings up the text edit dialog box. Slot names can have up to 24 characters. If a USB QWERTY keyboard (commercially available) is connected, you can use this to enter text instead of the on-screen keyboard. For more information, see "Editing names and entering text" on page 206 of the OG.

Color [List of colors]

You can assign each Slot to one of 16 different colors, to make it easier to distinguish between them quickly. You can also apply a color to a range of Slots at once.

Set List Slot Color

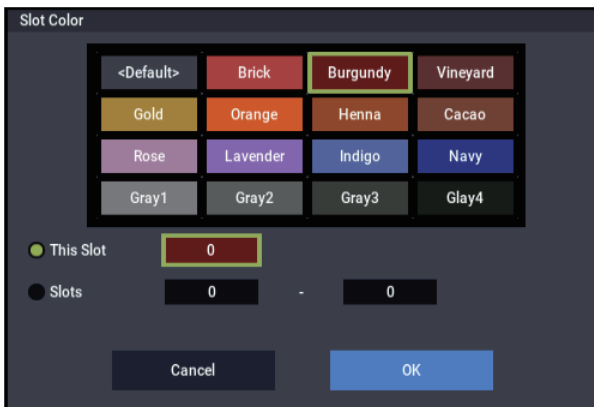

Comment [Text]

Each slot can have a comment of up to 512 characters, for lyrics, performance notes, and so on.

Pressing the text edit button brings up the comment edit dialog box, which has a few added features in comparison to the standard text editor:

- Text is displayed using the Slot's selected font.
- Touch and drag in the text display to select text and move the cursor.
- Use the LF button to insert line feeds (aka "returns").
- Multiple cut/copy clipboards are supported; see below for details.

If a USB QWERTY keyboard (commercially available) is connected, you can use this to enter text instead of the on-screen keyboard. Support for the Home, End, Return, and up/down arrows makes it easier to edit long comments or lyrics. For more information, see "Editing names and entering text" on page 206 of the OG.

Set List Edit Comment

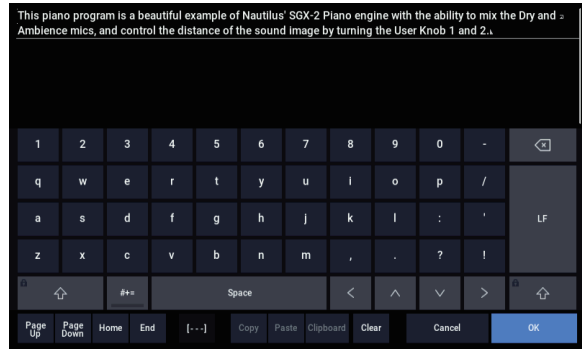

Multiple clipboards in the Comment editor

After copying text, press the Clipboard button to show the current contents of the clipboards. Each clipboard is represented by a button with an abbreviation of the text it contains. Ten clipboards can be retained at once. If an eleventh section of text is copied, the oldest clipboard is discarded.

Touch the buttons to paste the text into the comment. (The separate Paste button always pastes the most recent clipboard.) To remove a clipboard, enable its Remove checkbox and then press the Remove button.

Set List Edit Comment Clipboard



Font [S, M, L, XL]

This sets the font size for the Slot's comment. You can also set the font for a range of slots at once.

Set List Comment Font

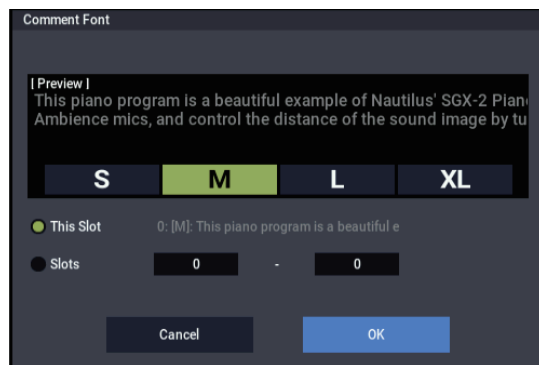

Volume [0...127]

This sets the volume for the current slot.

Note that the stored Master Volume setting of the Slot's Program, Combination, or Song still applies as well.

See the graphic below for details on how the Set List volume interacts with other volume controls.

Set List Slot Volume

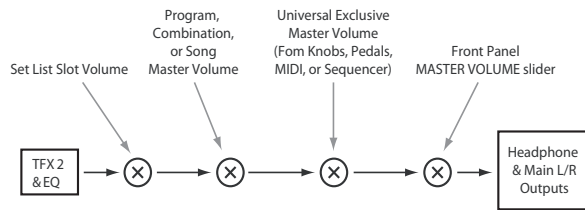
**Hold Time** [0...60 seconds]

Hold Time controls the duration of Smooth Sound Transitions. It sets how long reverbs, delays, and note releases continue to ring out after a new sound has been selected. The timer starts after all notes from the previous sound are no longer being held down, and the sustain pedal is released.

For other modes, the Global **Hold Time** parameter is used. In Set Lists, however, you can control this separately for every Slot. For instance, you might want a reverb to ring out a long time for one sound, but delays to fade away quickly for another.

Note that the Hold Time set here applies to the notes and effects of the current Slot, when transitioning into the next Slot.

For more information, see “Smooth Sound Transitions” on page 121 of the OG.

Transpose [-12...+0...+12]

This sets the transposition of the current slot, in semitones.

If the **Transpose** setting is any value other than +0, the transpose value is shown in the slot.

Slot Transpose works similarly to the Global Key Transpose parameter (see “Key Transpose” on page 631).

If the Slot contains a Program, its Drum Track Program is not affected by Transpose.

Similarly, if the Slot contains a Combination or Song, its Timbres or Tracks are not affected by Transpose if both of the following are true:

- The MIDI Channel is not the Global Channel, *and*...
- The Program’s Category is “Drums,” except for the sub-category “Pitched” (used for timpani, for instance)

Dynamics [0...127]

This adjusts how the volume and tone will be changed in response to how hard the keys are played (velocity) on this keyboard.

Pressing the button to turn DYNAMICS ON (the button will light) will enable the knob settings.

Turning the knob to the left will cause the sound to play softer in response to how hard you play the keys.

This is good for playing highly inflected passages from pianissimo (very soft) to fortissimo (very loud), such as solo piano or in band ensembles.

Turning the knob to the right will cause the sound to play louder in response to how hard you play the keys.

This is good for generally making your sound stand out when playing backing parts in a band ensemble, or when playing a solo.

The sound will not change when the knob is in center position.

For layered and split sounds, the dynamics effect will be applied to both sounds.

Note: The effect controlled may differ, depending on the Program. The dynamics will have no effect on Programs that do not change in volume or tone with velocity, such as organ sounds or some synth sounds.

Note: The effect will be applied to the selected velocity curve. For more information, see “Velocity Curve” on page 632.

1-1b: Slot Select**Slot Select** [000...127]

The 128 Slots are shown either 4, 8, or 16 at a time, depending on the selection at the top of the screen. To select a slot, simply touch it. For more information, see “0-1d: Slot Select” on page 561.

1-1c: Cut, Copy, Paste, and Insert

These buttons make it simple to re-arrange the Slots.

[---] (Multiple Slot selection tool)

This button allows you to select a range of slots. To use it:

1. **Select the Slot at one end of the desired range of slots (either the first or the last).**
2. **Press the [---] button.**

Notice that the selected Slot now has a different highlight color.

3. **Select the Slot at the other end of the desired range.**

Once the desired range is selected, use the Cut/Copy/Paste/Insert buttons, as described below, to operate on the Slots. The selected range is also used by the Font and Color parameters.

Cut

This places the selected Slot(s) on the clipboard, removes them from their position in the list, and moves the rest of the list to fill in the now-empty space. Information about the cut Slot(s) is displayed below the buttons.

Copy

This places a copy of the selected Slot(s) on the clipboard, leaving the original(s) in place. Information about the copied Slot(s) is displayed below the buttons.

Paste

This replaces the selected Slot(s) with the contents of the clipboard. Paste is only available if Slots have already been Cut or Copied.

Insert

This places the contents of the clipboard in front of the selected Slot(s), moving the rest of the list to make room. Insert is only available if Slots have already been Cut or Copied.

Adding items to the Set List, from other modes

PROGRAM, COMBINATION, and SEQUENCER modes each have a command in their Home page menus: **Add To Set List**. You can use this to add items to Set Lists while browsing through sounds, without needing to hop back and forth between modes.

For more information, see “Add To Set List” on page 113.

✓ 1-1: Page Menu Commands

- Compare →p.112
- Write Set List →p.569
- Exclusive Solo →p.113
- Initialize Set List →p.569
- Edit Program/Combination/Song →p.569
- Update Program/Combination →p.569
- PAGE →p.126
- MODE →p.126

SET LIST: Page Menu Commands

| | |
|-------------------------------|--------|
| Compare | →p.112 |
| Write Set List | →p.569 |
| Exclusive Solo | →p.113 |
| Initialize Set List | →p.569 |
| Edit Program/Combination/Song | →p.569 |
| Update Program/Combination | →p.569 |
| PAGE | →p.126 |
| MODE | →p.126 |

Write Set List

This command writes the current Set List into the NAUTILUS internal memory. It's available on every page in SET LIST mode.

Write Set List lets you:

- Save your edits
- Rename the Set List
- Make a copy of the Set List to a different location in memory

1. Select “Write Set List” to open the dialog box.

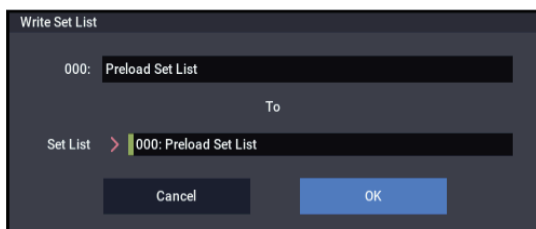

The upper line of the dialog shows the name of the Set List. To change the name:

2. Press the text edit button to open the text edit dialog box, enter the desired name, and then press OK to confirm.

If a USB QWERTY keyboard (commercially available) is connected, you can use this to enter text instead of the on-screen keyboard. For more information, see “Editing names and entering text” on page 206 of the OG.

To write to a different Set List number (to make a backup copy, for instance):

3. Press the Set List popup button, select the destination Set List number, and then press OK to confirm.

4. To Write the Set List, press the OK button. To cancel, press the Cancel button.

-  Do not turn off the power for at least 10 seconds after using the **Write Set List** command. This allows the system time to complete the process, which includes saving a backup of the data to the internal drive.

Initialize Set List

This brings up a confirmation dialog, with the text:

Initialize Set List: Are You Sure?

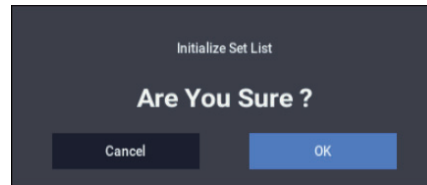

An OK button confirms the initialization; a Cancel button cancels the initialization.

When initialized, all 128 slots are set to the following:

Type: Program

Bank and Number: A 000

Slot Name: Slot [slotNumber]; e.g. Slot 27

Volume:127

Keyboard Track: 1

Hold Time: Global setting

The **Comment** field is left empty.

Edit Program/Combination/Song

This command allows you to edit the current Program, Combination, or Song in its native mode.

To do so:

1. Select the desired item in the Set List.

Next, from any of the Set List pages:

2a. In the menu, select the Edit [Type] command.

The actual name of the command will be either **Edit Program**, **Edit Combination**, or **Edit Song**, depending on the selected Slot.

or:

2b. Hold the ENTER button, and touch the Slot's button.

The mode will change to PROGRAM, COMBINATION, or SEQUENCER as appropriate, and the system will display the Home page for the selected item.

It shows that you are editing an item in a Set List. The Set List settings, including EQ and volume, continue to affect the sound.

3. Edit as desired.

4. Write your edits.

5. Press the MODE button to return to the SET LIST.

SET LIST mode will be as you left it, with the same Set List and Slot selected.

Update Program/Combination

This allows you to save edits made via the front-panel controls (mixer settings, Tone Adjust, ARP, tempo, etc.) without exiting SET LIST mode.

SAMPLING mode

Sampling Overview

The NAUTILUS can sample external audio from the analog, USB inputs, at 48 kHz 16-bit resolution (or 24-bit to drive), in mono or stereo. You can record samples into RAM, or sample directly to drive.

You can also digitally resample the complete sound of a Program, Combi, or Song, played live or sequenced, including any effects and Arpeggiator-generated events.

Once a sample is loaded into SAMPLING mode, you can use it directly in Drum Kits, or make it into a Multisample and use it anywhere that you use ROM Multisamples, including HD-1, STR-1, or MOD-7 Programs and Wave Sequences.

Once saved to drive, you can load your custom sounds as User Sample Banks, with access to Virtual Memory. For more information, see “User Sample Banks” on page 151 of the OG.

Sampling to RAM, or direct to drive

Sampling and RAM

The NAUTILUS comes with 3GB of RAM pre-installed. Approximately 1 GB of this RAM is used by the operating system and ROM sample data. The remainder is shared between the samples in EXs, User Sample Banks, and SAMPLING mode.

This means that the size of the currently loaded EXs and User Sample Banks trades off against the memory available for SAMPLING mode. The more space used by EXs and User Sample Banks, the less is available for SAMPLING mode.

The amount of sampling time depends on the amount of free RAM, as shown below.

You can check the amount of available sample RAM on the Recording page; for more details, see “0–1f: Free Sample Memory/Locations” on page 579.

Free RAM and approximate sampling times

| Free RAM | Approximate Sampling Time (min:sec) | |
|----------|-------------------------------------|--------|
| | Mono | Stereo |
| 16 MB | 2:54 | 1:27 |
| 64 MB | 11:39 | 5:49 |
| 128 MB | 23:18 | 11:39 |
| 256 MB | 46:36 | 23:18 |
| 512 MB | 93:12 | 46:36 |

Sampling to drive

You can sample directly to drive, creating a WAVE file. This lets you record up to 80 minutes continuously, in either mono or stereo (mono: approximately 440 MB, stereo: approximately 879 MB).

As long as they fit into the available RAM, these WAVE files can then be loaded into SAMPLING mode and used in HD-1, STR-1, or MOD-7 Programs, Drum Kits, or Wave Sequences.

WAVE files can also be used in audio tracks of the sequencer. For more information, see “Audio recording” on page 91 of the OG.

When sampling to drive, you can choose to record at either 16- or 24-bit resolution. 24-bit files can be used at full resolution in audio tracks; when loaded into SAMPLING mode, they are automatically converted to 16-bit data.

 Do not turn off the power for at least 10 seconds after sampling to drive. This allows the system time to complete the process.

Sampling features

Sampling on the NAUTILUS

The NAUTILUS features Korg's Open Sampling System. This lets you use sampling and resampling not only in SAMPLING mode but also in PROGRAM, COMBINATION, and SEQUENCER modes, with optimized features for each mode.

- You can perform 48 kHz 16-bit linear mono or stereo sampling (or 24-bit, when sampling to drive).
- A maximum of 4,000 multisamples and 16,000 samples can be created.
- In MEDIA mode, you can load multisample/sample data from various types of media.
- You can load several different sample formats, including Korg's own format, Akai S1000/3000 and SoundFont 2.0 samples and program data, and AIFF or WAVE samples.
- You can export samples created on the NAUTILUS as AIFF or WAVE files.
- You can use all of the Insert, Master, and Total effects to process signals before sampling, from either internal or external sources. For instance, you can use compression, EQ, decimation, etc. You can also use tempo-based LFO or delay effects, which can be very useful when sampling rhythmic loops.
- Sampling can be initiated by the front-panel SAMPLING or SEQUENCER START/STOP buttons, note-on, or threshold. (The available methods will depend on the mode.) Threshold allows you to start sampling when the input signal exceeds a specified level. In SAMPLING mode, you can also capture sound *before* the trigger.
- The analog audio inputs support mic and line level signals. The USB digital audio input supports the 48 kHz sample rate.

- Sampled data can be automatically converted into an HD-1 Program. It can then be edited and played just like any other Program, including processing with filters and effects. You could even re-sample that Program, and start all over again...

- Multisamples can be used in Wave Sequences.
- Individual samples can also be used in drum kits.

 When you turn off the power, all multisample and sample data in RAM memory will be lost. Before you turn off the power, be sure to save important data to drive. You can use the KSC Auto-Load feature to automatically load sets of samples at startup; for more information, see "0-3: KSC Auto-Load" on page 640.

 If **Auto Optimize RAM** (GLOBAL 0-1d) is on, and the writing destination for sampling data is RAM, the RAM memory will automatically be optimized after the data has been written. This is turned on by default, but you may switch it on/off as necessary. For more information, see "Auto Optimize RAM" on page 635, and "Optimize RAM" on page 610.

Editing in SAMPLING mode

- In SAMPLING mode, the sample data you sampled or loaded from various media (including WAVE and AIFF formats) can be assigned to an index (zone) to create a multisample.
- The waveform can be viewed in the LCD screen, and edited by a variety of commands including rate conversion (down-sampling) and reverse playback.
- Start, loop start, and end addresses can be specified in single-sample units. Loop tune, reverse playback, and loop lock functions are also supported.
- The Use Zero function automatically searches for zero-cross points, making it easy to find the beginning or end of the waveform, or locations that will not produce noise when the sample is played back.

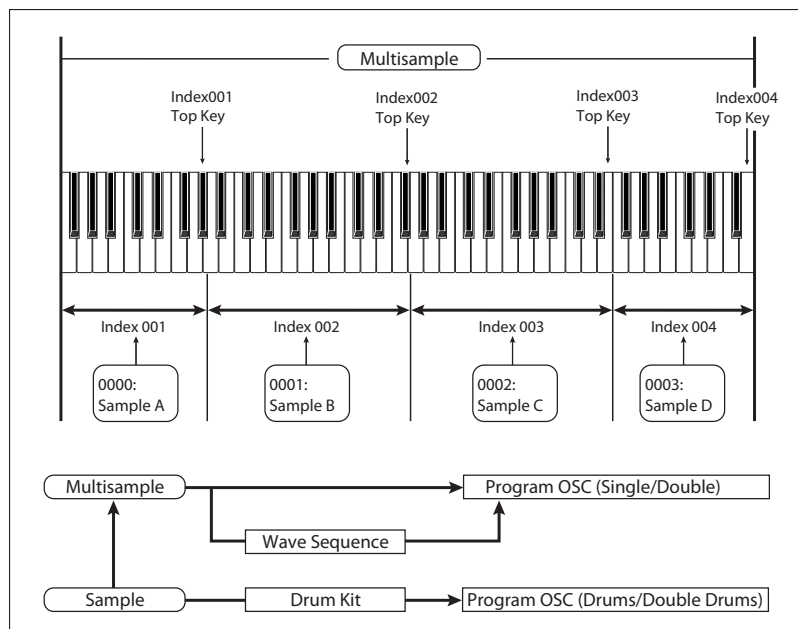

- The grid function displays a BPM-based grid on the waveform display, helping you to create loops or make waveform edits that match the desired BPM. At this time, you can set the BPM value by pressing TAP button in rhythm with the sample playback.
- Each multisample allows you to create up to 128 indices. Each index consists of a sample assignment, a key zone, an original key, a playback pitch, and settings such as level.
- The “Keyboard” display lets you edit a multisample while viewing the assignments and zones of each sample.
- Sample names and multisample names can be assigned. Sample names and multisample names can also be viewed in MEDIA mode (see “Translation” on page 703).
- The **Time Slice** function automatically detects the attack portions of a kick or snare etc. in a rhythm loop sample (a looped pattern of drums etc.), and divides it into separate rhythm instrument sounds. Either stereo or mono samples can be used. A pattern corresponding to the divided samples is created automatically, so that you can immediately use the SEQUENCER mode RPPR function to play the pattern and adjust the tempo without changing the pitch. You can also do things such as adjusting the pitch of only the snare, replacing it with a different sample, or changing the playback timing on the sequencer, in this way creating a new rhythm loop based on the one you started with.
- The **Time Stretch** function lets you modify the tempo without changing the pitch of a sample. You can select either Sustaining (suitable for sustain-type instruments such as strings or vocals), or Slice (suitable for rhythm loops on decay-type instruments such drums). Stereo samples are supported.
- The **Crossfade Loop** function is an important looping tool that helps smooth out irregularities in long loops which contain complex material. By executing Crossfade Loop, you can eliminate this problem and create natural-sounding loops.
- The **Link** (with **Crossfade**) function allows you to join two samples into a single sample. You can also crossfade the overlapping portion of the samples at this time, so that the volume changes gradually, producing a natural-sounding transition.
- The **BPM Adjust** function (playback pitch adjust) lets you adjust the playback pitch of each index so that the loop frequency matches the desired BPM value.
- You can use resampling (auto) to automatically apply effects to a sample and create a new sample.
- A multisample you create can easily be converted into a program (**Convert MS To Program**).
- In SAMPLING mode, the selected multisample or sample will sound when you play the keyboard, allowing you to hear the edited content of that page.

Sampling in PROGRAM, COMBINATION, and SEQUENCER modes

- A performance in PROGRAM, COMBINATION, or SEQUENCER modes can be resampled internally, with all audio remaining in digital form. This lets you resample a performance that uses the NAUTILUS’s filters, effects, Arpeggiator, and sequencer etc.
- External audio sources from the various input jacks can be sampled. A performance played on the NAUTILUS can be mixed with the external audio source and sampled, or you can sample just the external audio source while monitoring the performance played on the NAUTILUS.
- In SEQUENCER mode when you sample an external audio source while listening to the playback of the song, note data will be automatically created in the track. You can use this In-Track Sampling function to sample vocals or guitar while the sequencer is running.

Note: Changing velocity on the keyboard

In SAMPLING mode, you cannot use velocity to control the loudness of the sound. However, you will be able to use velocity to control effects if you select Velocity as a Dmod Source.

For example, you might make settings as follows.

Bus Select **All OSC to: IFX1** (IFX– Routing)

IFX1: 005: Stereo Limiter, On (IFX– Insert FX)

Stereo Limiter:

Ratio 1.0:1

Gain Adjust [dB] -Inf

Source: Velocity or Exponential Velocity

Amount +40

If you are converting a user multisample into a program for use in PROGRAM mode, you can raise the Amp/EQ–Amp1(2) Mod. “Velocity Intensity” value as desired to control the sound.

SAMPLING > Recording

This page is where you make basic settings for recording (sampling), including:

- Creating and editing multisamples and indexes
- Specifying the writing-destination for the samples you record, and selecting either mono or stereo samples
- Specifying the sampling time, loop settings, and +12dB boost
- Specifying the output destinations for the external audio inputs
- Selecting the source to sample
- Setting the recording level

0-1: Recording



Here you can create and edit multisamples and indexes, specify the write-destination for newly recorded samples, and select stereo or mono sampling. You can also specify the sampling time, loop settings, +12dB boost, and adjust the final level of the input signal.

While you can record samples on any of the pages in SAMPLING mode, this page is particularly convenient due to its level meter, memory display, and basic setup parameters.

Note: If you're recording from the audio inputs, make sure that you've set things up correctly on the Recording– Audio Input page. For more information, see “0-8: Audio Input” on page 581.

0-1a: Multisample Select (MS)

Multisample Select (MS) [0000...3999]

This selects the multisample.

Each multisample consists of the samples for one or more indexes (an **Index** is a range or zone of keys).

This parameter can also be set from Sample Edit – Multisample page group.

When the Multisample Select window is open, you can use the Find button to search for Multisamples by name. For more information, see “Find dialog” on page 7.

Creating a new sample

To create a new multisample,

1. Press the “Multisample Select” popup button to access the popup menu.
2. Select a number for which the multisample name is blank.

When you select a new multisample number, the **Create New Multisample** dialog box will appear.

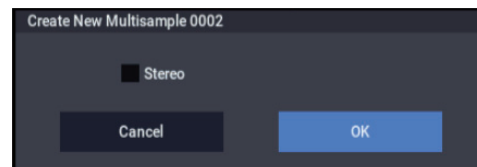

3. If you wish to create a stereo multisample, check “Stereo.”
4. To create the multisample, press the OK button. To cancel, press the Cancel button.

A multisample will be created as follows (example).

```

Mono    0001: NewMS_____001
Stereo  0001: NewMS_____001-L
        0002: NewMS_____001-R
    
```

Keyboard

Keyboard: This shows the key range, original key, and root key for the selected index. The red triangles indicate the keyboard range, and the white triangle indicates the C4 key.

Keyboard

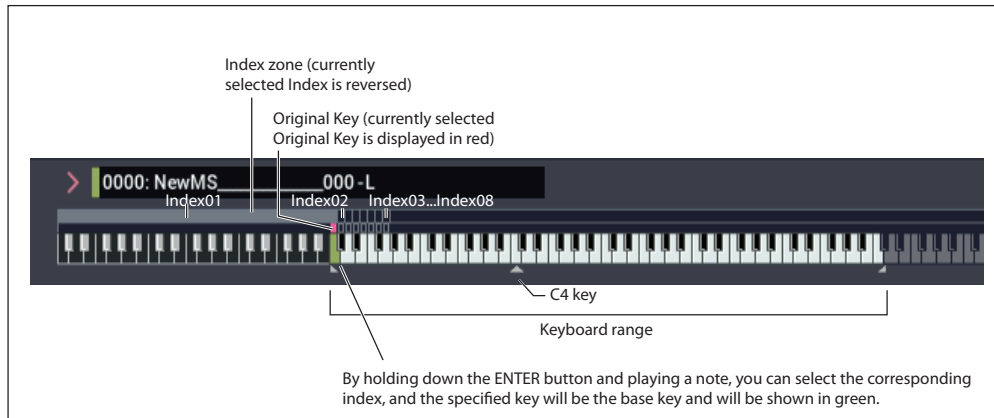

Note: The base key (displayed in green)

- Playback in the grid display of Sample Edit page and Loop Edit page will be according to the playback pitch of the base key selected here, and the specified tempo BPM/resolution.
- The **Pitch BPM Adjust** menu command is based on the playback pitch of the base key you specify here.

0-1b: Index, Sample Select, Original Key, Top Key, Create

Here you can set the sample, original key, and range of the selected index.

Index [xxx (001...128)/yyy (001...128)]

This selects the index to view and edit.

Each zone in a multisample is called an **Index**. For example on the 73-note keyboard, a multisample could be divided into seven zones of one octave (12 keys) each. Each of these zones is referred to as an **Index**. You will assign a sample to each of these indexes.

xxx: The selected index. Choose the desired index.

yyy: The total number of indexes in the multisample.

Note: You can also select an index by holding down the ENTER button and playing a note on the keyboard. The index that includes this note will be selected. The key you specify will be the base key, and will be displayed in green in the keyboard graphic. (“Keyboard” 0-1a)

This parameter can also be set from each page of Sample Edit, Loop Edit, and Multisample Edit: Multisample. Sampling and editing in the respective page will apply to the index that you select here.

Immediately after the power is turned on, this will be 001/008. This indicates that there are eight indexes, and that currently the first index is selected.

To increase the number of indexes, use **Create** in this page. When you press the Create button, indexes will automatically be added from the left-most zone, as 002/002, 003/003, ... (The position, zone width, and original key location of the index that is created when you press the Create button can be set in Create Zone Preference (0-1e, 3-1c). You are also free to modify the zone width and original key location later.)

Sample Select

[----: ---No Assign----, 00000...15999]

Selects a sample that you sampled or loaded in MEDIA mode, and play a note within the index range to sound that sample. The sample you select here is the sample that will be affected by your sampling and editing operations in the various pages. This parameter is also available in each page of Sample Edit, Loop Edit, and Multisample Edit.

----: ---No Assign----: No sample is assigned to the index. There will be no sound when you play the keyboard.

When the Sample Select window is open, you can use the Find button to search for Samples by name. For more information, see “Find dialog” on page 7.

To record a sample, select a vacant sample such as 00000:.. When you record a sample, data will be loaded into the selected sample. The sample name (such as NewSample_00000) will be shown beside the number. This sample name can be modified using the **Rename Sample** menu command.

You can also record a sample even when ----:---No Assign--- is displayed. In this case, a sample number will be selected automatically.

Even if you record to a sample that already contains data, the selected sample will not be overwritten—the data will automatically be sampled to a vacant sample, and the newly recorded sample will replace the previous sample in the index. If you wish to delete a sample, execute the **Delete Sample** menu command.

Original Key

[C-1...G9]

Specifies the key that will play the sample at its original pitch (i.e., the pitch at which it was recorded). The pitch will change in semitone steps relative to the original key.

For example, suppose that you recorded a sample with **Original Key** of F2. When the zone of the index is C2-B2, pressing the F2 key would playback the sample at its original pitch. Pressing F#2 would playback the sample a semitone higher. Pressing E2 would playback the sample a semitone lower. The pitch of this sampled sound will change in semitone steps between C2 and B2, centered at F2.

The original key location can also be viewed in “Keyboard.”

Note: If **Constant Pitch** (3-1b) is checked, the sample will be sounded at its original pitch by all notes in the zone.

Top Key

[C-1...G9]

Specifies the highest key in the zone of the index. The zone is defined by this **Top Key**.

For example, suppose that you set a **Top Key** of B2 for index 001/002, and a **Top Key** of B3 for index 002/002. This means that the zone of index 001 will be B2 and lower, and the zone of index 002 will be C3–B3.

Range

This indicates the zone (area) that was determined by the **Top Key** setting.

The sample selected by **Sample Select** will sound in this area. The zone for each index can also be viewed in “Keyboard.”

Create

This creates an index. Use this when you wish to add a sample to a multisample.

When you press the Create button, a new index will be created according to the Create Zone Preference (0–1e, 3–1c) parameters **Position**, **Zone Range**, and **Original Key Position**.

If you wish to delete an index or exchange indexes, use Multisample Edit page.

⚠ If when you execute **Create** (0–1b, 3–1b) or **Insert** (3–1b) it is not possible to create a new index according to your Create Zone Preference settings, one of the following dialog boxes will appear. If you wish to create a new index, perform the following procedure.

- **Set Top Key:** Select **Index** 001, set **Position** (0–1e, 3–1c) to Left (to Selected Index), and execute **Create** or **Insert** to open the dialog box. So that a new index can be created at the left of index 1, re-set the **Top Key** setting, and press the OK button.

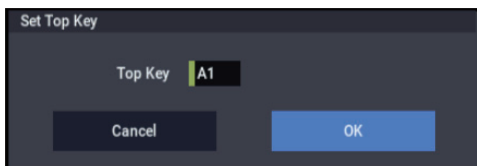

- **Set Zone Range:** If you execute **Create** when it is not possible to create a new index according to the Create Zone Preference settings, the following dialog box will appear. This dialog box will also appear if you execute **Insert** when it is not possible to create a new index with the contents of the **Cut** or **Copy**. Re-set the **Zone Range**, and press the OK button.

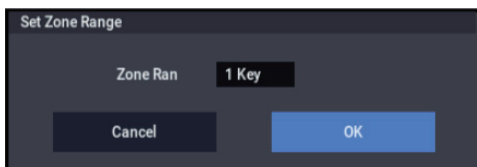

Stereo

A **STEREO** indication will appear here if you have selected a stereo multisample or sample, or if you recorded a sample with **Mode** (0–1d) set to Stereo.

About stereo multisamples and stereo samples

Stereo multisamples: Under the following conditions, two multisamples will be handled as a stereo multisample.

- If you checked **Stereo** when creating a new multisample (i.e., selected a new multisample in **Multisample Select** 0–1a)
- If you executed the **MS Mono To Stereo** page menu command
- If you sampled with **Mode** (0–1d) set to Stereo

In these cases, a stereo multisample will be created automatically using the following criteria.

- 1) The last two characters of the two multisample names will be -L and -R respectively, and the earlier portion of the names are identical.
- 2) The two multisamples will have the same number of indexes, and their zone settings are identical.

Stereo samples: Under the following condition, two samples will be handled as a stereo sample.

- When the samples were recorded with **Mode** (0–1d) set to **Stereo**
- If you executed the **Sample Mono To Stereo** page menu command

In these cases, a stereo multisample will be created automatically using the following criteria.

- 1) The last two characters of the sample name will be -L and -R respectively, and the earlier portion of the names are identical.
- 2) Two samples that satisfy condition 1) for stereo multisamples are selected.

⚠ Stereo multisamples and samples are distinguished internally by their names. If you use **Rename MS** or **Rename Sample** menu commands to modify multisample or sample names, please pay attention to the above conditions.

⚠ As a condition of a stereo sample, the sampling rates must be identical. You can verify the sampling rate of a sample by using the page menu command “Rate Convert.” Be aware that if you use **Rate Convert** to convert the -L and -R samples to differing sampling rates, they will no longer be handled as a stereo sample.

ADC OVERLOAD !

If the signal level from AUDIO INPUT 1 & 2 jacks is too high, the “ADC OVERLOAD !” indication will appear. You’ll need to adjust the Analog Input Setup, or the output level of your external audio source.

0–1c: Rec Level [dB]

Recording Level

[–Inf, –72.0...+18.0]

This adjusts the signal level at the final stage of sampling.

For more information, see “Setting levels” on page 27, “Tips for eliminating distortion when using the analog inputs” on page 27, and “Avoiding extraneous noise” on page 27.

Level Meter

This adjusts the signal level at the final stage of sampling. This setting can also be made in the Recording– Audio Input page.

Press the SAMPLING REC button to enter sampling standby mode, where you can adjust the signal level with the slider. Start by setting the level to “0.0”, and bring up the level shown by the bar so that it does not exceed 0 dB.

Note that if the “Recording Level” is still distorted even after you lower the signal, the signal might still be distorted (if you are using analog inputs) depending on the settings of the AUDIO INPUT stage or the internal effects.

See the Recording– Audio Input page to check whether the signal levels of the AUDIO INPUT stage are overloading. Distortion is occurring due to signal overload in the AUDIO INPUT stage if “ADC OVERLOAD!” appears above the “Recording Level” bar. Adjust the levels in “Analog Input Setup” so that the message does not appear.

If the signal distorts even after you turn down the analog input gain, the settings of the internal effects may be causing the distortion. Try turning (Input 1, 2) “Level” (0–8a) down, or adjust the effect settings.

CLIP !

If 0 dB is exceeded, the display will indicate “CLIP !” This means that the level of the sampling signal is too high, so adjust the level as described under “Setting levels” on page 27.

Note: When signals are input to the AUDIO INPUT 1/2 jacks, adjust the level in “Analog Input Setup” so that they are at their maximum without “ADC OVERLOAD!” being displayed. This will let you sample at the widest dynamic range possible. Further, set the “Level” (0–8a) to “127”, and adjust the “Recording Level” (0–1c, 0–8b) so that the “CLIP!” message does not display.

Note: If you have sampled at a low input level, you can use the **Normalize/Level Adj.** menu command to amplify the level to the maximum possible without clipping. For more information, see “Normalize/Level Adjust” on page 617.

You can check the remaining amount of RAM in the section labeled “0–1f: Free Sample Memory/Locations,” as described on page 579.

Note: The amount of RAM available for user sampling will vary depending upon both the amount of physical RAM installed, and the size of the currently loaded EXs banks. For more information, see “Sampling and RAM” on page 571.

Data written into RAM will be lost when the power is turned off, so you must save it if you want to keep it.

Disk: The sound will be recorded to drive as a WAVE file. You can select a drive (internal or USB), directory, and name for the recorded file using the **Select Directory/File for Sample to Disk** menu command.

Once recorded, you can audition the sample directly from the **Select Directory/File for Sample to Disk** window; just select the file and press the **SAMPLING START/STOP button**. To stop playback, press the **SAMPLING START/STOP button** again.

If the sample will fit into RAM, you can also load it into SAMPLING mode (using the Load command in MEDIA mode).

Data You cannot load a drive sample (WAVE file) that exceeds the amount of available RAM.

Mode [L-Mono, R-Mono, Stereo]

Specifies the channel(s) that you want to sample, and specify whether a mono or stereo sample will be created. For more information, see “Source Bus” on page 581.

L-Mono: The L channel of the **Source Bus** will be sampled in mono.

R-Mono: The R channel of the **Source Bus** will be sampled in mono.

Stereo: The L and R channels of the **Source Bus** will be sampled in stereo, creating a stereo multisample.

Sample Time [min] [sec]

Specifies the amount of time that you wish to sample, in 0.001 second increments.

Immediately after the power is turned on, this parameter indicates amount of remaining RAM memory in the selected memory bank (the available sampling time). If you record a sample in this condition, the change in time will be displayed automatically.

If **Save to** is set to **DISK**, the maximum value is calculated from the amount of remaining space on the selected drive.

0-1d: REC Sample Setup

Save to [RAM, Disk]

Specifies the destination to which the data will be written during sampling.

RAM: The sound will be sampled into RAM for use in SAMPLING mode.

Audio input/output

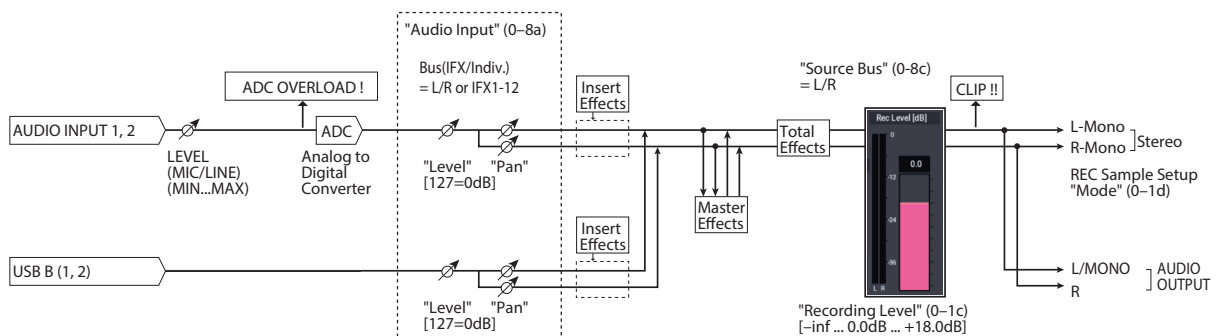

Tips: If you have sufficient RAM memory, it is a good idea to set an ample “Sample Time,” and to use the “Truncate (for Sample Edit),” “Truncate (for Loop Edit)” page menu command after you sample to delete unwanted portions of the sample and reduce it to the minimum size necessary. You can also press the SAMPLING START/STOP button to manually stop sampling after you have recorded the desired material.

For more details on sampling please see “Sampling (Open Sampling System)” on page 123 of the OG.

 If **Save to** is set to RAM, and you continue sampling with **Auto Optimize RAM** disabled, wasted space will develop in memory, decreasing the amount of available RAM. In this case, use the **Optimize RAM** command to recover the wasted space. For more information, see “Optimize RAM” on page 610.

Note: “Free Sample Memory/Locations” (0–1f) lets you check the remaining amount of RAM.

The remaining amount of memory will depend on the following conditions:

- The amount of memory that is installed.
- The size of any loaded EXs samples.
- Whether sampling in stereo or in mono. If **Mode** (0–1d) is set to Stereo, the maximum “Sample Time” will be halved.
- The time specified for “Pre Trigger REC” (0–8c: a function that automatically samples the sound even before you begin sampling) will be subtracted from the amount of memory that actually remains.

Auto Loop On [Off, On]

On (checked): Looping will automatically be enabled for newly recorded samples. For more information, see “Loop (Loop On)” on page 590.

Auto +12dB On [Off, On]

On playback, samples are normally reduced in volume by 12dB, to reduce the chance of clipping when playing many voices simultaneously. This parameter lets you defeat the volume reduction for individual samples, when desired.

In general, +12dB should be On for drums and loops (so that they play at the same level as they were recorded), and Off for any sounds that you play polyphonically. For more information, see “+12dB” on page 590.

On (checked): +12dB will automatically be enabled for newly recorded samples.

Off (unchecked): +12dB will not be enabled for newly recorded samples. You can still enable it manually for individual samples as desired, at any time. This is the default setting.

This setting applies only when **Save to** is set to **RAM**. It does not apply if **Save to** is set to **DISK**.

Note: **Auto +12 dB On** is set separately for each mode: PROGRAM, COMBINATION, SEQUENCER, and SAMPLING. In SAMPLING mode, **Auto +12 dB On** is disabled by default.

Sample to Disk [16-bit, 24-bit]

This sets the bit depth for sampling to disk. Note that this does not affect sampling to RAM. This same parameter appears on the sampling setup pages in PROGRAM, COMBINATION, SEQUENCER, and SAMPLING modes; changes in one place are reflected everywhere.

The resulting 24-bit files can be used at full resolution in audio tracks. When loaded into SAMPLING mode, they are automatically converted to 16-bit data.

Sampling examples

Example: Sampling a mono source connected to AUDIO INPUT 1

If using the Audio Input:

Source Bus: Audio Input 1/2 (0–8c)

Resample: Manual (0–8c)

Rec Level [dB]: as desired (0–1c)

Mode: L-Mono (0–1d)

(→ see diagram in 0–8c: Source Bus = Audio Input 1/2)

If using the L/R Bus:

Input1 Bus Select (IFX/Indiv.): L/R (0–8a)

Input1 Pan: L000 (0–8a)

Input1 Level: 127 (0–8a)

Source Bus: L/R (0–8c)

Resample: Manual (0–8c)

Rec Level [dB]: as desired (0–1c)

Mode: L-Mono (0–1d)

(→ see diagram in 0–8c: Source Bus = L/R)

Example: Sampling a mono input, with internal stereo effects

Here, we’ll apply the internal insert effect 101: Reverb Hall to a mono source connected to AUDIO INPUT 1, and then sample in stereo.

Input1 Bus Select (IFX/Indiv.): IFX1 (0–8a)

Input1 Pan: C064 (0–8a)

Input1 Level: 127 (0–8a)

Source Bus: L/R (0–8c)

Resample: Manual (0–8c)

IFX1: select 101: Reverb Hall (IFX– Insert FX page)

Rec Level [dB]: as desired (0–1c)

Mode: Stereo (0–1d)

(→ see diagram in 0–8c: Source Bus = L/R)

Example: Sampling a stereo source connected to AUDIO INPUTS 1 and 2

If using the Audio Input:

Source Bus: Audio Input1/2 (0–8c)

Resample: Manual (0–8c)

Rec Level [dB]: as desired (0–1c)

Mode: Stereo (0–1d)

(→ see diagram in 0–8c: Source Bus = Audio Input1/2)

If using the L/R Bus:

Input1 **Bus Select (IFX/Indiv.):** L/R (0-8a)
 Input1 **Pan:** L000 (0-8a)
 Input1 **Level:** 127(0-8a)
 Input2 **Bus Select (IFX/Indiv.):** L/R (0-8a)
 Input2 **Pan:** R127 (0-8a)
 Input2 **Level:** 127 (0-8a)
Source Bus: L/R (0-8c)
Resample: Manual (0-8c)
Rec Level [dB]: as desired (0-1c)
Mode: Stereo (0-1d)
 (→ see diagram in 0-8c: Source Bus = L/R)

Example: sampling a stereo input, with internal effects

Here, we'll apply the internal effect 012: St.Graphic 7EQ to a stereo source connected to AUDIO INPUTS 1 and 2, and then sample in stereo.

Input1 **Bus Select (IFX/Indiv.):** IFX1 (0-8a)
 Input1 **Pan:** L000 (0-8a)
 Input1 **Level:** 127 (0-8a)
 Input2 **Bus Select (IFX/Indiv.):** IFX1 (0-8a)
 Input2 **Pan:** R127 (0-8a)
 Input2 **Level:** 127 (0-8a)
Source Bus: L/R (0-8c)
Resample: Manual (0-8c)
 IFX1: select 012: St.Graphic 7EQ (IFX- Insert FX page)
Rec Level [dB]: as desired (0-1c)
Mode: Stereo (0-1d)
 (→ see diagram in 0-8c: Source Bus = L/R)

0-1e: Create Zone Preference

These settings define the initial state of the indexes that are created when you press the Create button (0-1b, 3-1b). Each new index will be created according to the settings you make here, but you are free to modify the settings later.

Position **[Right (to Selected Index), Left (to Selected Index)]**

Specifies whether the new index will be created at the right or left of the selected index.

Right (to Selected Index): The new index will be created at the right of the currently selected index.

Left (to Selected Index): The new index will be created at the left of the currently selected index.

Zone Range **[1 Key...127 Keys]**

Specifies the key range of the newly created index.

1 Key: Each individual note of the keyboard will be an index. The sample of an index will sound at its original key when you play that note.

2 Keys-127 Keys: The sample will change pitch in semitone steps across the specified number of keys, centered on the original key **Original Key** (0-1b, 3-1b). If **Constant Pitch** (3-1b) is checked, the pitch will not change.

Original Key Position **[Bottom, Center, Top]**

Specifies where the original key will be located in the zone (specified by "Zone Range") for a newly created index.

Bottom: The lowest key in the zone will be the original key.

Center: The middle key in the zone will be the original key.

Top: The top key in the zone will be the original key.

0-1f: Free Sample Memory/Locations

RAM **[000.0...999.9 sec]**

This shows the remaining amount of sample RAM, in both seconds and bytes. The free RAM determines the available sampling time, the maximum size of sample files that can be loaded in MEDIA mode, and the maximum size of samples during editing. The graph to the right shows the free space in white, and the used space in blue.

Note that the amount of RAM available for user sampling will vary depending upon both the amount of physical RAM installed, and the size of the currently loaded EXs banks.

Multisamples **[0000...3999/4000]**

Samples **[00000...15999/16000]**

Samples in MS **[00000...15999/16000]**

These show the number of multisamples and samples in RAM, as well as the number of samples which are already placed in multisamples. The current numbers are shown on the left, and the maximum numbers are shown on the right.

The graphs to the right show the free amounts in white, and the used amounts in blue.

0-1g: Sampling button

SAMPLING REC

Press the button to enter sampling standby.

To begin sampling, press the SAMPLING START/STOP button.

SAMPLING START/STOP

Press this button after pressing the SAMPLING REC button.

Next, one of the following three things will occur depending on the "Trigger" settings.

- When "Trigger" is set to "Sampling START Button", pressing this button will immediately begin sampling.
- When "Trigger" is set to "Note On", sampling begins after you press this button and then play a key (note on) on the keyboard.
- When "Trigger" is set to "Threshold", sampling begins after you press this button and the threshold level is reached for the audio source.

Press this button on the Sample Edit page in SAMPLING mode to play back the selected sample.

✓ 0-1: Page Menu Commands

- Delete Sample →p.606
- Copy Sample →p.606
- Rename Sample →p.606
- Move Sample →p.607
- Sample Mono To Stereo (Change Sample Type) →p.607
- Delete MS (Delete Multisample) →p.608
- Copy MS (Copy Multisample) →p.608
- Rename MS (Rename Multisample) →p.608
- Move MS (Move Multisample) →p.608
- Convert MS To Program (Convert Multisample To Program) →p.609
- MS Mono To Stereo/MS Stereo To Mono (Change Multisample Type) →p.610
- Select Directory/File for Sample To Disk →p.115
- Auto Sampling Setup →p.611

- PAGE →p.126
- MODE →p.126

0–8: Audio Input

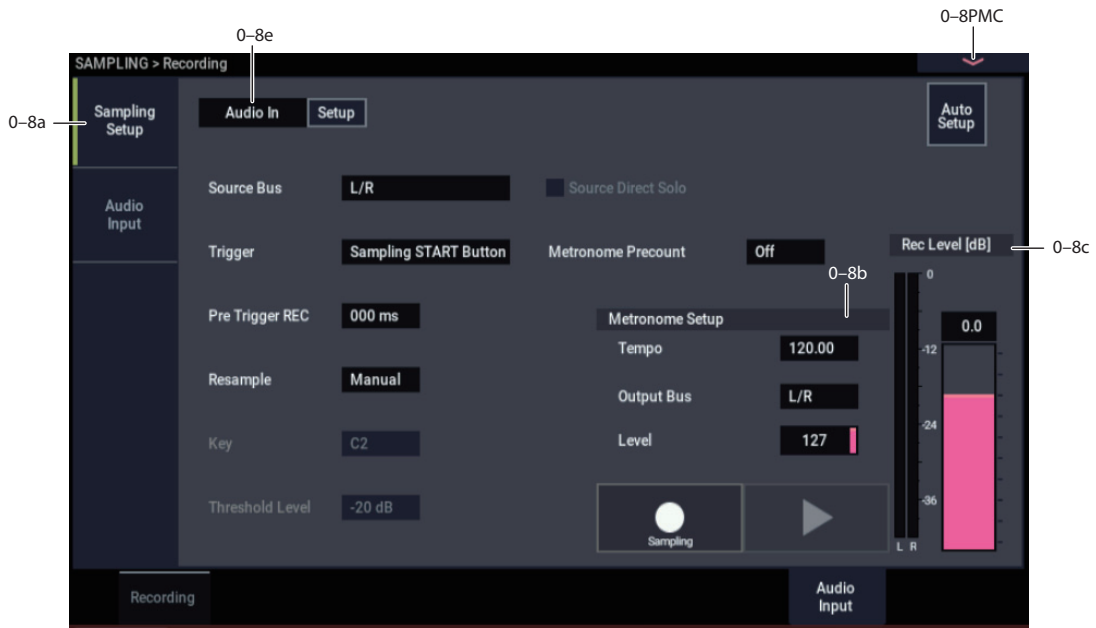

Here you can specify the output destination and input level etc. for the external audio signals being input from the INPUT jacks. Here you can also specify the source that will be sampled, and specify how sampling will be initiated. You can also specify a metronome count-down before sampling begins.

0–8a: Sampling Setup

Source Bus [Audio Input1/2, USB 1/2, L/R, REC1/2...3/4, Indiv.1/2...3/4]

You can sample in stereo from the audio inputs, from the two stereo REC busses, or from the signal at any of the 6 outputs (L/R and Individual 1/2-3/4).

When you sample from an output pair or REC bus, you'll record all audio sent to the output or bus, including internal Programs or Combis, effects, audio inputs, and HDR audio.

When sampling in stereo, the odd-numbered channel (such as 1 or 3) corresponds to the left channel, and the even-numbered channel (such as 2 or 4) corresponds to the right. For more information, please see "Source Bus" on page 22.

Source Direct Solo [Off, On]

This selects what is heard through the L/R outputs and headphones when Sampling REC is enabled.

On (checked): Only the signal of the selected **Source Bus** will be heard. This lets you hear only the sound that will be sampled.

Off (unchecked): The signal of the selected **Source Bus** will be merged with the main L/R signal. This is the default.

Note: If **Source Bus** is set to **L/R**, this setting is ignored—since that signal is normally heard at the L/R outputs already!

Trigger [Sampling START button, Note On, Threshold]

Specifies how sampling will be initiated.

Sampling START button: Pressing the SAMPLING REC button will cause the NAUTILUS to enter sampling-standby mode, and sampling will begin when you press the SAMPLING START/STOP button.

Note On: Press the SAMPLING REC button and then press the SAMPLING START/STOP button to enter sampling-standby mode. Sampling will begin when you play the keyboard.

MIDI Sampling will also begin if a MIDI note-on is received (instead of playing the keyboard).

Threshold: Sampling will begin automatically when the input level exceeds the specified **Threshold Level**.

Using Trigger = Sampling START button

1. Press the SAMPLING REC button to enter sampling-standby mode.
2. Use the “Rec Level [dB]” slider to adjust the sampling level.
3. Sampling will begin when you press the SAMPLING START/STOP button.

(If you are using the “Metronome Precount” function, pressing the SAMPLING START/STOP button will cause sampling to begin after the metronome sounds a count-down. If Metronome Setup “Output Bus” (0–8d) is set to L/R, the metronome will stop sounding at the moment that sampling begins.)

4. To stop sampling, press the SAMPLING START/STOP button once again.

Sampling will also stop automatically if it continues to the specified **Sample Time** (0–1d).

If you want to create a new sample by processing an existing sound through effects (Resampling), set **Trigger** to Sampling START button, and set **Resample** (0–8c) to Auto.

Using Trigger = Note On

1. Perform steps 1 and 2 described above.
2. Press the SAMPLING START/STOP button.
3. When you play the keyboard or when a MIDI note-on is received, sampling will start automatically.
4. To stop sampling, perform step 4, above.

Using Trigger = Threshold

1. Press the SAMPLING REC button to enter sampling-standby mode.
2. Use the “Rec Level [dB]” slider to adjust the sampling level.

 Be careful of changes in the monitoring volume. (**Rec Level [dB]** 0–8b)

3. Adjust the Level setting. The red triangles at both sides of the “Rec Level [dB]” level bar display will indicate the Level value.

Normally you will set this to a low a level as possible without allowing sampling to be triggered by noise.

4. Press the SAMPLING START/STOP button. When the input level exceeds the Level you specified, sampling will begin automatically.

5. To stop sampling, press the SAMPLING START/STOP button once again.

Alternatively, sampling will end automatically if it continues to the time specified for **Sample Time** (0–1d).

Pre Trigger REC [000...500ms]

If you want a portion of sound immediately before the start of sampling to be included in the recorded sample, set this parameter to specify the length.

When sampling with **Trigger** Threshold, sampling will start when the input signal exceeds the **Level** threshold level. However if the **Level** setting causes a portion of the attack to be lost, you can set the “Pre Trigger REC” parameter to capture the early attack as well.

When sampling with **Trigger** Sampling START button, it is best to use “Metronome Precount” so that the instrumental performance etc. is sampled in tempo. If the performance is ahead of the tempo, this Pre Trigger REC parameter lets you sample without losing any of it.

 If you increase this setting, you will always be sampling an unneeded portion ahead of the desired sample. Normally you should set this to 000 ms, and specify the minimum required length when necessary.

Metronome Precount [Off, 4, 8, 3, 6]

This specifies whether the metronome will sound a count-down before sampling begins. This can be set only if **Trigger** is set to Sampling START button.

Off: Sampling will begin immediately when you press the SAMPLING START/STOP button from recording-standby mode.

4, 8, 3, 6: When you press the SAMPLING START/STOP button from recording-standby mode, the metronome will count the specified number of beats at the system tempo, and then sampling will begin. If you set this to 4, sampling will begin on the count of 0 after a pre-count of 4–3–2–1–0.

The output destination and level of the metronome sound are specified by Metronome Setup (0–8d). If **Output Bus** is set to L/R, the metronome will stop sounding the instant sampling actually begins.

Resample [Manual, Auto]

Specifies how resampling will occur.

This can be set only if **Trigger** is set to Sampling START button.

The process of sampling a sample (or samples) is called “resampling.”

You can apply effects to a sample and then resample it, or resample a performance of samples that you play.

Manual: This is the normal method. Use this when you want to sample an external input sound. If a sample is already assigned, the sample assigned for playing from the keyboard will be resampled together with the external input sound.

Auto: The sample assigned to the index will be resampled automatically. Use this when you want to apply an effect to a sample and resample it.

1. Set Key to the keyboard location where the sample you that you want to resample is assigned.

 Sampling will not be possible if you specify a key to which a sample has not been assigned.

2. **If you want to apply an insert effect, set the IFX–Routing page Bus Select (8–1b) parameter to IFX1–12, and select the insert effect you want to use.**
If you want to apply a master effect, use the IFX–Routing page (OSC MFX Send) **Send1** and **Send2** parameters to adjust the send levels, and use MFX/TFX to select the master effect(s) you want to use. If you want to apply a total effect, use MFX/TFX to select the total effect you want to use.
3. **Set Source Bus (0–8c) to L/R.**
4. **Press the SAMPLING REC button to enter record-ready mode.**
5. **When you press the SAMPLING START/STOP button, the current sample will play back automatically, and the resampling will begin.**
If you play the keyboard at this time, the sound you play will be resampled together with the source sample.
6. **When the sample assigned to the Key has played back for its full length, resampling will end automatically.**
Alternatively, you can stop resampling by pressing the SAMPLING START/STOP button once again.

Note: When resampling ends, the **Bus Select** (8–1b) setting will automatically be reset to L/R. At the same time, the “MFX1 On/Off,” “MFX2 On/Off,” “TFX1 On/Off,” and “TFX2 On/Off” (“9–1: Routing”) settings will automatically be turned off. These settings are made automatically so that the effect will not be applied again (i.e., a second time) when you play back the sample that was resampled with the effect. Please be aware of this if you want to resample once again. The parameters of the newly created sample will be automatically set the same as the source sample when played back.

Key [C-1...G9]

When “Resample” is set to Auto, this specifies the note to which the sample to be resampled is assigned.

This can be set only if **Trigger** is set to Sampling START button.

For the resampling procedure, see “Resample” Auto.

Threshold Level [-63dB...0dB]

When sampling with **Trigger** set to Threshold, this specifies the level at which sampling will begin. This can be set only when **Trigger** is set to Threshold. See step 3 of the **Trigger** Threshold procedure.

0–8b: Metronome Setup

These parameters apply when Metronome Precount is used. For more information, see “Metronome Precount,” above.

Tempo [040.00...300.00]

This sets the system tempo, which controls the metronome. You can also set the tempo by using the TAP button.

Note that this is the main system tempo, and will affect all other tempo-synchronized functions, such as delays and LFOs.

Output Bus [L, R, 1...4]

This sets the audio output for the metronome sound.

L/R: The metronome will be heard in the main stereo outputs (L/Mono and R), and the headphones.

Indiv.1...4: The metronome will be heard only in the selected individual output.

Level [000...127]

This controls the volume of the metronome sound.

0–8c: Rec Level [dB]

Recording Level [-Inf, -72.0...+18.0]

Level Meter

CLIP !

For more information, please see “0–1c: Rec Level [dB]” on page 576.

0–8d: Audio Input

Input 1 & 2

These are settings for analog inputs 1 & 2.

Bus Select (IFX/Indiv.) [L/R, IFX1...12, 1...4, 1/2...3/4, Off]

This specifies the main bus routing for the input signal.

L/R: The input signal will be sent to the L/R bus.

IFX1...12: The input signal will be sent to the IFX1–12 bus. Choose one of these settings if you want to apply an insert effect while sampling.

1...4: The input signal will be sent to the specified INDIVIDUAL OUTPUT in monaural. The **Pan** setting will be ignored.

1/2...3/4: The input signal will be sent in stereo (including the effect of the **Pan** control) to the specified INDIVIDUAL OUTPUT pair.

Off: The input signal will not be routed directly to the outputs or Insert Effects. However, it may still be routed to an FX Control Bus or REC Bus.

FX Control Bus [Off, 1, 2]

This sends the external audio input signal to an FX Control bus (two stereo channels; FX Ctrl 1 and 2). See “FX Control Buses” on page 735.

REC Bus [Off, 1...4, 1/2, 3/4]

This sends the external audio input signal to the REC buses (four mono channels; 1...4).

Use the REC buses when you want to sample in any mode, or to record audio tracks in SEQUENCER mode. These are dedicated buses for recording.

You can sample these signals by setting **Source Bus** (0–8c) to REC bus.

Normally you will set **Source Bus** (0–8c) to L/R, and sample the signal from the L/R bus. However, you can use the REC buses when you want to play the keyboard while sampling only the audio input. You can also mix several audio input sources to the REC buses, or mix the direct sound of an audio input with sound processed by an insert effect and mix them to the REC buses for sampling. See the diagram “Source Bus = REC Bus 1/2” (0–8c).

Off: The external audio signal will not be sent to the REC buses. Normally you will use the Off setting.

1...4: The external audio input signal will be sent to the specified REC bus. The **Pan** setting is ignored, and the signal is sent in monaural.

1/2, 3/4: The external audio input signal will be sent in stereo to the specified pair of REC buses. The **Pan** setting sends the signal in stereo to buses 1 and 2 or buses 3 and 4.

Send1 (to MFX1) [000...127]

Send2 (to MFX2) [000...127]

These adjust the levels at which the external audio input signal is sent to the master effects.

Send1 (to MFX1): Send the signal to master effect 1.

Send2 (to MFX2): Send the signal to master effect 2.

If **Bus Select (IFX/Indiv.)** is set to IFX1–12, the send levels to the master effects are set by the post-IFX1–12 **Send1** and **Send2** (8–5a).

MUTE [Off, On]

Turns on/off mute for the external audio signal being inputted.

The external audio signal input to the channels on which mute is turned on will be muted (silent), and will not be input.

Solo

Turns on/off Solo for the external audio signal being input.

Sound will be output only from channels for which Solo is On. Samples, and multisamples will be muted.

The setting of the **Exclusive Solo** page menu command specifies how the Solo function will operate.

Exclusive Solo Off: Selected is off, you can solo multiple audio inputs. The solo status will change each time you press Solo.

Exclusive Solo On: Selected is on, pressing a Solo button will solo only that audio input.

 The **Solo** setting is not memorized when you Write.

Pan [L000...C064...R127]

This specifies the panning of the external audio input signal. When using a stereo audio source, you will normally set the inputs to L000 and R127 respectively.

Level [0...127]

This controls the level of the external audio signal. The default is 127.

The meter to the left of the slider shows the audio input volume, before the Level control, in realtime.

Note: The audio input signal level before the signal passes through the Level control is shown.

 Analog audio signals coming through the AUDIO INPUT 1/2 jacks will be converted into digital signals by the ADC. This sets the signal level directly after the conversion to digital. If the sound distorts even when you turn the level down considerably, the distortion may be occurring prior to the ADC. Adjust the “Analog Input Setup” or external sound source output level.



Set “Bus Select (IFX/Indiv.)” to any setting besides off, and then raise the “Level” value to input the sound from the external input into the NAUTILUS. When you connect audio cables to the AUDIO INPUT 1/2 jacks at this time, the noise component of the audio signal may go through the ADC and into the NAUTILUS even if there is no audio signal, and then be output from AUDIO OUTPUT L/R and 1–8. When you are not using external inputs, turn “Bus Select (IFX/Indiv.)” off, or set the “Level” to “0”. This also applies to the “REC Bus” and “FX Control Bus”. If you are not using these buses, turn them off.

ADC OVERLOAD !

If the signal level from AUDIO INPUTS 1 & 2 is too high, the “ADC OVERLOAD !” indication will appear. You’ll need to adjust the Audio Input Setup, or the output level of your external audio source.

USB1 & 2

These are settings for the USB inputs. They are identical to those described under “Input 1 & 2,” above.

0–8e: Audio In

Audio In [On, Off]

Switches the audio input on/off. This works in tandem with the AUDIO IN button on the front panel.

Setup

Press the Setup button to display the Analog Input Setup dialog box.

Audio Input Setup dialog

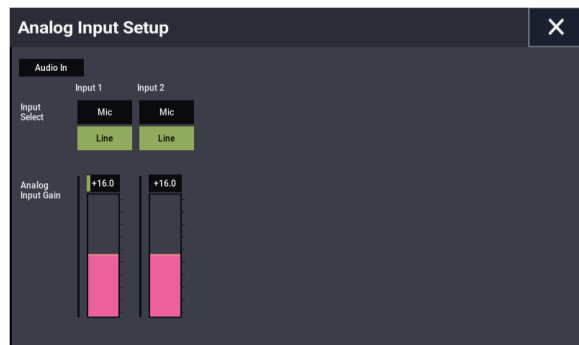

→Analog Input Setup dialog

✓ 0-8: Page Menu Commands

- Delete Sample →p.606
- Copy Sample →p.606
- Rename Sample →p.606
- Move Sample →p.607
- Sample Mono To Stereo (Change Sample Type) →p.607
- Delete MS (Delete Multisample) →p.608
- Copy MS (Copy Multisample) →p.608
- Rename MS (Rename Multisample) →p.608
- Move MS (Move Multisample) →p.608
- Convert MS To Program (Convert Multisample To Program) →p.609
- MS Mono To Stereo/MS Stereo To Mono (Change Multisample Type) →p.610
- Optimize RAM →p.114
- Select Directory/File for Sample To Disk →p.115
- Auto Sampling Setup →p.611

- PAGE →p.126
- MODE →p.126

SAMPLING > Sample Edit

In this page you can edit sample data (waveform data). You can make detailed edits while watching the sample waveform display. Here are the main operations you will perform in this page.

- Truncate (delete unwanted regions), copy, paste, move, normalize (boost the level as high as possible without distortion), rate convert (lower the sampling frequency),

reverse (backward playback), and link (connect two samples)

- When performing the above operations, you can automatically detect zero-crossing points, or display a grid (vertical lines) and edit according to BPM values or beats

1-1: Sample Edit



1-1a: Multisample Select (MS)

Multisample Select [0000...3999]

Selects the multisample that contains the sample you wish to edit.

Keyboard

For more information, please see “0-1a: Multisample Select (MS)” on page 574.

1-1b: Index, Sample Select, Range

Index [xxx (001...128)/yyy (001...128)]

Selects the index of the sample you wish to edit. Your editing will affect the sample of the index that you select here, and the waveform will appear in the **Sample waveform display** (0-1a).

Note: An index can also be selected by holding down the ENTER button and playing a note on the keyboard. The index that includes this note will be selected. The key you played will be the base key, and will be displayed in green in the keyboard graphic. (“Keyboard” 0-1a)

Sample Select

[----: ---No Assign----, 00000...15999]

Range

[C-1...B9 - C-1...B9]

This shows the sample number and name for the selected index, and the range. If you modify “Sample Select,” the sample you specify here will be assigned to this index (0-1b). The range of the index is shown at the right.

1-1c: Sample waveform display

Sample waveform display

This displays the waveform of the selected sample. The horizontal axis is the sample address (time axis), and the vertical axis is the sample level.

In the following diagram, “a” indicates the entire sample. “b” indicates the portion of the entire sample that is shown in “c”. As you zoom-in on the time axis, this shows you where the magnified portion lies within the overall sample. You can use the ZOOM buttons to magnify (zoom-in) or shrink (zoom-out) the portion shown in the “c” waveform display.

If you have selected a stereo multisample or sample, the L channel and R channel of the sample data will be shown above and below.

Sample waveform display

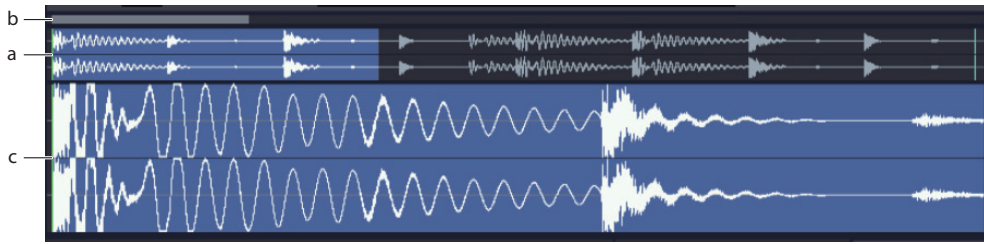

1-1d: Edit Range

Start [00000000...]

End [00000000...]

This specifies the range (start address and end address) of the sample that will be edited by page menu commands. (This is shown in sample address units.)

The range you specify here will be highlighted in the Sample waveform display.

To audition the selected range, press the SAMPLING START/STOP button or Play button. The sample in the area between **Start** and **End** will sound at the pitch of the currently selected key (displayed in green) (“Keyboard” 0-1a).

Use Zero [Off, On]

On (checked): When setting **Start** and **End**, it will be possible to select these only to locations where the waveform level is ±0 (i.e., where the waveform crosses the center line of the **Sample waveform display**). You can use the VALUE dial, and +/- buttons, to automatically search for zero-crossing addresses. By using the numeric keys you can search for the zero-crossing address nearest to the value that you input.

Off (unchecked): **Start** and **End** can be set in increments of one. This is the normal setting.

Edit Range PLAY/STOP

The “Edit Range” will play back when you press the Play button. During playback, this is shown as STOP.

1-1e: Grid

Grid [Off, On]

On (checked): A grid (vertical lines) is superimposed on the sample waveform display. Use “Resolution” and **Tempo** to adjust the grid spacing. Use this setting when you want to cut or edit sample data in units of BPM values or beats.

The starting point of the grid is specified by the Sample Start setting in P2: Loop Edit. If Loop is off, the grid is displayed starting at the **Start** address. If Loop is on, the grid is displayed starting at the **Loop Start** address. The grid indicates the state of the sample when it is played at the currently selected base key (displayed in green). (“Keyboard” 0-1a)

Resolution [01 031 01 031 01 031 01 031]

This specifies the resolution of the grid. The grid is defined by this setting and “Tempo.”

Tempo [040.00...480.00]

This specifies the spacing of the grid. The grid is defined by this setting and **Resolution**.

You can also set this by using the TAP button.

Tip: If you don’t know the tempo of the sample, set the tempo by pressing the TAP button several times in rhythm with the playback.

Note: 240.00 is the maximum value that you can set using the TAP button.

1-1f: ZOOM

ZOOM

These buttons let you zoom-in and zoom-out the **Sample waveform display** along the horizontal axis (sample addresses) or vertical axis (sample level).

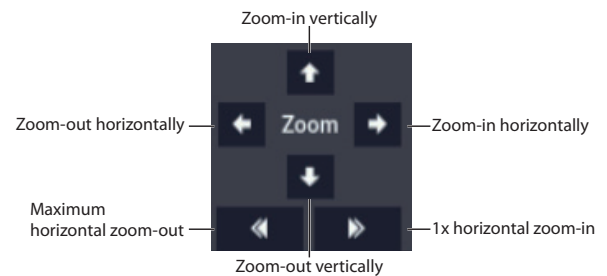

By zooming-in on the horizontal direction, you can move from the overall display where the waveform is shown as a solid line (1X magnification) to 2X or 4X magnification. (With 1X magnification, the display resolution of the LCD will be the same as the resolution of the sample addresses. For example if you change the sample address by one, the vertical line in the LCD that indicates the sample address will move in steps of one pixel.) In the vertical axis, you can zoom-in from 1X (full range display) to 512X (or 1024X in the case of stereo display).

Zoom-In/zoom-out will occur starting at the **Start** or **End** points you specify. (If a different parameter is selected when you zoom-in or -out, the zoom-in/out will be based on the last-selected point. If you re-select the **Start** or **End** points when the display is zoomed in or out, the display range will be adjusted so as to show the selected point.)

⚠ If the zoom ratio is low (1X or less), the **Sample waveform display** may differ slightly from the displayed waveform before and after waveform editing, but this does not affect the playback sound. If this occurs, raising the zoom ratio will make the display accurate.

✓ 1-1: Page Menu Commands

- Delete Sample →p.606
- Copy Sample →p.606
- Rename Sample →p.606
- Move Sample →p.607
- Sample Mono To Stereo (Change Sample Type) →p.607
- Delete MS (Delete Multisample) →p.608
- Copy MS (Copy Multisample) →p.608
- Rename MS (Rename Multisample) →p.608
- Move MS (Move Multisample) →p.608
- Convert MS To Program (Convert Multisample To Program) →p.609
- MS Mono To Stereo/MS Stereo To Mono (Change Multisample Type) →p.610
- Optimize RAM →p.114
- Select Directory/File for Sample To Disk →p.115
- Auto Sampling Setup →p.611
- Truncate (for Sample Edit) →p.613
- Cut →p.614
- Clear →p.614
- Copy →p.615
- Insert →p.615
- Mix →p.615
- Paste →p.616
- Insert Zero →p.616
- Normalize/Level Adjust →p.617
- Volume Ramp →p.617
- Rate Convert →p.618
- Reverse →p.618
- Link →p.619

- PAGE →p.126
- MODE →p.126

SAMPLING > Loop Edit

In this page you can specify the region of the sample that will play and the portion that will loop. You can edit the waveform down to the level of individual samples while watching the sample waveform display. Here are the main operations you will perform in this page.

- Specify the looping locations (start address, loop start address, end address)
- Truncate (delete unwanted regions), copy, paste, move
- When performing the above operations, you can automatically detect zero-crossing points, or display a grid (vertical lines) and edit according to BPM values or beats
- Make settings for reverse (backward) playback
- Use the **Time Slice** or Time Stretch functions to automatically edit the sample according to BPM values or beats

2-1: Loop Edit



2-1a: Multisample Select (MS)

Multisample Select [0000...3999]

Here you can select the multisample to edit.

Keyboard

For more information, please see “0-1a: Multisample Select (MS)” on page 574.

2-1b: Index, Sample Select, Range

Index [xxx (001...127)/yyy (001...127)]

Selects the index whose loop and other sample parameters you wish to edit. Your edits will apply to the sample of the index selected here, and the waveform will appear in the **Sample waveform display** (0-1a).

You can also select an index by holding down the ENTER button and playing a note on the keyboard. The index that includes this note will be selected. The note you played will be the base key, and will be shown in green in the keyboard graphic. (“Keyboard” 0-1a)

Sample Select

[----: ---No Assign----, 00000...15999]

Range

[C-1...G9 - C-1...G9]

This selects the sample of the index. If you change “Sample Select,” the sample you specify will be assigned to this index (0-1b). The sample you select here will appear in the “Sample waveform display.”

The range of the index is displayed at the right.

2-1c: Sample waveform display

Sample waveform display

This shows the waveform of the selected Sample. For more information, please see “1-1c: Sample waveform display” on page 586.

2-1d: Sample Setup

Start (Start Address)

[000000000...]

This specifies the start point for sample playback, in single-sample units.

Loop Start (Loop Start Address) [00000000...]

This specifies the loop start point, in single-sample units. This applies only when **Loop** is **On**.

The **Loop Start** must be between the **Start** and **End** points. For more information, see “Start Offset” on page 52.

End (End Address) [00000000...]

This specifies the end point for sample playback, in single-sample units. When **Loop** is **On**, this is the end point of the loop.

Loop (Loop On) [Off, On]

Specifies whether or not the sample will be looped.

On (checked): When played, the sample will loop repeatedly between the **Loop Start** and **End** points.

For instance, **Start**→ **End**→ **Loop Start**→ **End**→ **Loop Start**→ ...

Off (unchecked): The sample will play once from **Start** to **End**, and then stop. This is sometimes called one-shot playback.

If you sample with **Auto Loop On (0-1d)** checked, **Loop** will be enabled automatically.



Start Loop Start End

- Loop "One" - "Two" - "Two" - "Two" - ...
- Loop "One" - "Two"



Start Loop Start End

- Loop "One" - "Two" - "One" - "Two" - "One" - "Two" - ...
- Loop "One" - "Two"

Reverse [Off, On]

On (checked): The sample will be played backward, from the **End** to the **Loop Start**.

+12dB [Off, On]

On playback, samples are normally reduced in volume by 12dB, to reduce the chance of clipping when playing many voices simultaneously. This parameter lets you defeat the volume reduction for individual samples, when desired.

In general, **+12dB** should be **On** for drums and loops (so that they play at the same level as they were recorded), and **Off** for any sounds that you play polyphonically—unless the samples are very low in level.

Note that this setting does not change the sample data itself; it only affects the way that the sample is played back.

On (checked): The sample playback level will be approximately +12dB louder than if this setting were **Off (unchecked)**.

Off (unchecked): The sample will play back using the same standard level as the ROM Multisamples and Drum Samples.

You can enable this automatically during sampling by enabling the **Auto +12dB** check-box. For more information, see “Auto +12dB On” on page 578.

This setting is saved in Korg format sample files (.KSF), and is recognized by the KRONOS, OASYS, M3, TRITON Extreme, and TRITON STUDIO. However, it is ignored by older Korg-format-compatible devices. For more information, see “Korg format sample files” on page 942.

Since it does not affect the sample data itself, this parameter is ignored when exporting to other formats, such as AIFF or WAVE.

+12dB is automatically enabled for converted AKAI, AIFF, and WAVE format samples.

Loop Tune [-99...+99]

When you loop a sample, the pitch of the looped portion may sometimes be slightly different from the sustained portion. Use this parameter to compensate for such cases.

This parameter adjusts the playback pitch of the loop over a range of ±99 cents.

Use Zero [Off, On]

On (checked): **Start**, **End** and **Loop Start** can be set these only to locations where the waveform level is ±0 (i.e., “zero-cross” addresses where the waveform crosses the center line of the **Sample waveform display**). (1-1d)

Off (unchecked): **Start**, **End** and **Loop Start** can be set in steps of one unit. This is the normal setting.

Loop Lock [Off, On]

This fixes the length of the loop being edited.

On (checked): This links the **Loop Start** and **End** points. When one of these points is edited, the other will be adjusted automatically to keep the loop length the same. This is convenient when you are creating a rhythm loop to match a specific tempo.

2-1e: Grid

Grid [Off, On]

On: A grid (vertical lines) is superimposed on the sample waveform display. Use **Resolution** and **Tempo** to adjust the grid spacing. For more information, see “1-1e: Grid” on page 587.

Resolution [Musical notation]

Tempo [040.00...480.00]

2-1f: ZOOM

ZOOM

This allows you to zoom-in/out in horizontal and vertical directions of the **Sample waveform display** (1-1f).

✓ 2-1: Page Menu Commands

- Delete Sample →p.606
- Copy Sample →p.606
- Rename Sample →p.606
- Move Sample →p.607
- Sample Mono To Stereo (Change Sample Type) →p.607
- Delete MS (Delete Multisample) →p.608
- Copy MS (Copy Multisample) →p.608
- Rename MS (Rename Multisample) →p.608
- Move MS (Move Multisample) →p.608
- Convert MS To Program (Convert Multisample To Program) →p.609
- MS Mono To Stereo/MS Stereo To Mono (Change Multisample Type) →p.610
- Optimize RAM →p.114
- Select Directory/File for Sample To Disk →p.115
- Auto Sampling Setup →p.611
- Truncate (for Sample Edit) →p.613
- Time Slice →p.620
- Time Stretch →p.625
- Crossfade Loop →p.629

- PAGE →p.126
- MODE →p.126

SAMPLING > Multisample Edit

In this page you can edit multisamples. You can create, delete, copy, and paste indexes, and assign samples to indexes. You can also edit detailed settings such as level and pitch for each index. Here are the main operations you will perform in this page.

- Create and edit multisamples and indexes
- Edit the playback level and pitch of samples
- Delete, copy, and paste indexes

3-1: Multisample Edit

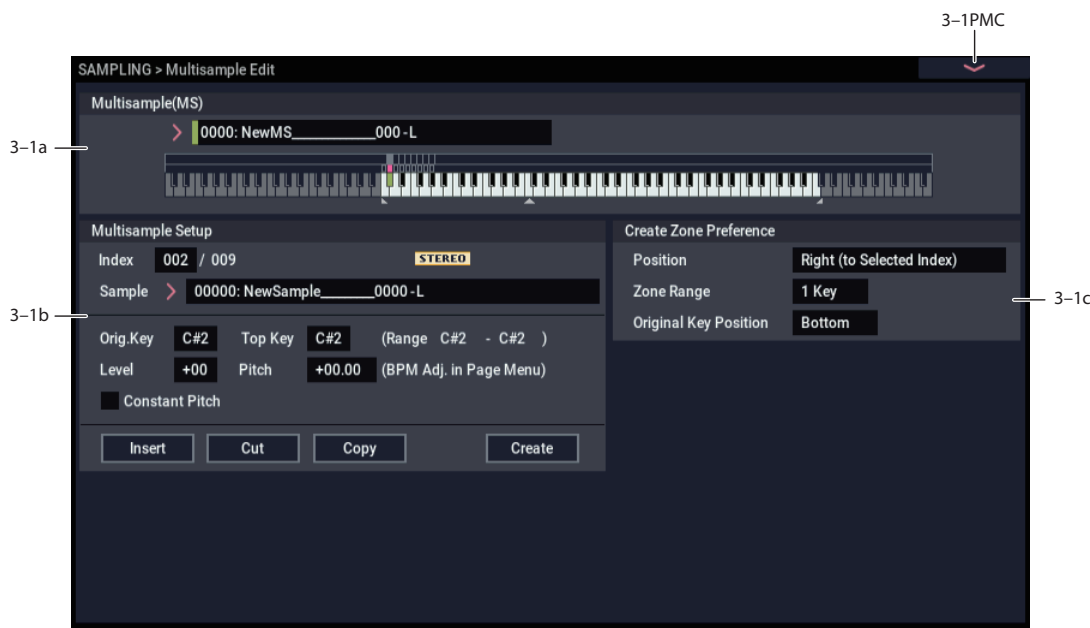

3-1a: Multisample Select (MS)

Multisample Select (MS) [0000...3999]

Select the multisample that you wish to edit.

Keyboard

For more information, please see “0-1a: Multisample Select (MS)” on page 574.

3-1b: Multisample Setup

Index [xxx (001...128)/yyy (001...128)]

Selects the index (the sample key zone within the Multisample) that you wish to edit.

You can also select an index by holding down the ENTER button and playing a note on the keyboard. The index that includes this note will be selected. The selected key will be the base key, and will be displayed in green in “Keyboard.”

Sample Select [----: ---No Assign----, 00000...15999]

This indicates the number and name of the sample that is assigned to the selected index. You can also select the sample here. (0-1b)

Stereo

This area will indicate “Stereo” if a stereo multisample or sample is selected, or if you sampled with a setting of Stereo in **Mode** (0-1d).

Original Key [C-1...G9]

Specifies the original key of the sample (0-1b).

Top Key [C-1...G9]

Specifies the highest key in the zone of the index. The zone is defined by this **Top Key** (0-1b).

Range [C-1...G9]

This shows the range of the zone that is determined by the **Top Key** setting. The selected sample data will playback within this area. Zone settings for an index can also be viewed in “Keyboard” (0-1a).

Level [-99...+99]

Adjusts the playback level of the sample. Use this when you need to adjust the level balance between samples within a multisample.

0: Unity level

-: The level will be lowered.

+: The level will be raised.

⚠ Since in SAMPLING mode the playback unity level will normally be the maximum level, adjustments in the + direction will have no effect. If Volume (CC#07) or Expression (CC#11) has been assigned to the ASSIGNABLE PEDAL or as the RT control knobs 1-6 and these controllers have been operated, or if these MIDI messages have been received to lower the playback unity level, then adjustments in the + direction will be valid.

Note: The playback level will also be affected by the +12dB setting. If +12dB is on, the sample will play back approximately +12dB louder. For more information, see “+12dB” on page 590.

Pitch (BPM Adj. In Page Menu) [-64.00...+63.00]

Adjusts the playback pitch of the sample in one-cent steps.

- 0:** The sample will sound at the original pitch when the original key is played.
- :** The pitch will be lowered. At a setting of -12.00 the pitch will be one octave lower.
- +:** The pitch will be raised. At a setting of +12.00 the pitch will be one octave higher.

You can also use **Pitch** to make fine adjustments in the length of a rhythm loop. For example with a setting of +12.00, the playback speed will be doubled, and the loop playback time will be 1/2. (Program, Sample Parameters: Pitch)

Note: The **Pitch BPM Adjust** page menu command lets you set the playback time in terms of a BPM value.



Constant Pitch

On (checked): All notes in the zone of the index will sound at the pitch of the original key. Use this setting when you have sampled a drum sound or a rhythm loop, and want it to always playback at the original pitch.

Off (unchecked): The pitch will change in semitone steps, based on the original key. Use this setting when you have sampled a musical instrument sound etc. and would like to play it conventionally from the keyboard.

Insert

This creates an index. When you press the Insert button, a new index will be created according to the **Position** setting (0-1e, 3-1c). At this time, the contents of the index that was cut or copied by **Cut** or **Copy** (i.e., the **Zone Range**, **Original Key Position**, **Level** and **Pitch**) will be assigned at the same time. (The sample will automatically be copied or assigned to a different number.)

-  If it is not possible to create a new index when you execute **Create** or “Insert,” a dialog box will appear. If this occurs, see **Create** (0-1b).
-  If you have not yet executed **Cut** or **Copy**, such as immediately after power-on, the new index will be created according to the Create Zone Preference settings (0-1e, 3-1c) **Position**, **Zone Range**, and **Original Key Position**.

Cut

This deletes the selected index. At the same time, the contents of the deleted index are copied to the **Insert** buffer.

Copy

This copies the content of the selected index to the **Insert** buffer.

Create

This creates an index. When you press the Create button, a new index will be created according to the settings of **Position**, **Zone Range**, and **Original Key Position**. (3-1c, 0-1e) (0-1b).

3-1c: Create Zone Preference

Position [Right (to Selected Index), Left (to Selected Index)]

Zone Range [1 Key...127 Keys]

Original Key Position [Bottom, Center, Top]

Here you can specify the default settings for indices that are created by executing **Create** (3-1b, 0-1b). New indexes will be created according the settings you specify here. You are free to modify the settings of an index later. Also, when you execute **Insert** (3-1b), the **Position** setting specified here will be used. (Create Zone Preference: 0-1e)

✓ 3-1: Page Menu Commands

- Delete Sample →p.606
- Copy Sample →p.606
- Rename Sample →p.606
- Move Sample →p.607
- Sample Mono To Stereo (Change Sample Type) →p.607
- Delete MS (Delete Multisample) →p.608
- Copy MS (Copy Multisample) →p.608
- Rename MS (Rename Multisample) →p.608
- Move MS (Move Multisample) →p.608
- Convert MS To Program (Convert Multisample To Program) →p.609
- MS Mono To Stereo/MS Stereo To Mono (Change Multisample Type) →p.610
- Optimize RAM →p.114
- Select Directory/File for Sample To Disk →p.115
- Auto Sampling Setup →p.611
- Pitch BPM Adjust →p.629

- PAGE →p.126
- MODE →p.126

SAMPLING > EQ

In this page you can edit a mid-sweepable three-band EQ that is applied to the output of the multisample.

4-1: EQ



Here you can edit the mid-sweepable three-band EQ that is applied to the output of the multisample.

4-1a: 3 Band Parametric EQ

(All OSCs)

Bypass [Off, On]

When Bypass is checked, all of the EQ will be disabled, including the Input Trim.

Bypass can be convenient for comparing the results of the EQ with the original signal.

Input Trim [00...99]

This adjusts the level of the signal going into the EQ. A setting of 50 corresponds to -6 dB, and a setting of 25 corresponds to -12 dB.

High settings of the Low, Mid, and High Gain controls can cause substantial increases in the overall level. You can compensate for this by turning down the input trim.

(Freq Response Graphic)

Low Gain [-18.0...+00.0...+18.0dB]

This controls the gain of the 80Hz Low Shelf EQ, in increments of 0.5dB.

Mid Frequency
[100...500 (10Hz step) ... 1.0k (20Hz step) ... 2.0k (50Hz step) ... 10.0k (100Hz step)]

This sets the center frequency for the Mid sweep EQ.

Mid Gain [-18.0...+00.0...+18.0dB]

This controls the gain of the Mid Sweep EQ, in increments of 0.5dB.

High Gain [-18.0...+00.0...+18.0dB]

This controls the gain of the 10kHz High Shelf EQ, in increments of 0.5dB.

✓ 4-1: Page Menu Commands

- Delete Sample →p.606
- Copy Sample →p.606
- Rename Sample →p.606
- Move Sample →p.607
- Sample Mono To Stereo (Change Sample Type) →p.607
- Delete MS (Delete Multisample) →p.608
- Copy MS (Copy Multisample) →p.608
- Rename MS (Rename Multisample) →p.608
- Move MS (Move Multisample) →p.608
- Convert MS To Program (Convert Multisample To Program) →p.609
- MS Mono To Stereo/MS Stereo To Mono (Change Multisample Type) →p.610
- Optimize RAM →p.114
- Select Directory/File for Sample To Disk →p.115
- Auto Sampling Setup →p.611
- PAGE →p.126
- MODE →p.126

SAMPLING > IFX

Here you can make insert effect settings for use in SAMPLING mode.

If you want to apply an insert effect IFX1–12 to the external audio signal while you sample it, choose IFX1–12 as the **Bus Select (IFX/Indiv.)** (0–8a) parameter for Input1–4, and adjust the parameters of the insert effect.

If you want to apply effects to a previously-sampled sample or a sample you loaded, and resample the result, set the P8: Insert Effect page “Bus Select (All OSCs to)” (8–1b) parameter to IFX1–12, and adjust the effect settings. (“Resample” 0–8c)

For instance, you can:

- Send the output of a multisample to an insert effect
- Route a sound to an insert effect

- Make detailed settings for insert effects
- Make common LFO settings for effects

For details on insertion effects, see “Effect Guide” on page 731.

 Insert effect settings for SAMPLING mode will revert to the default settings when the power is turned off.

Use “Copy Insert Effect” if you want to keep your insert effect settings. Select a program or combination, copy the insert effect settings of SAMPLING mode, and save them. Write the program or combination to save it in internal memory. Then in SAMPLING mode, use “Copy Insert Effect” to load the effect settings from the program or combination so that they can be used in SAMPLING mode.

You can also use the “Save to User Preset” menu command to save effects individually.

8-1: Routing



8-1a: Routing Map

Routing Map

This displays the status of the insert effect settings.

This indicates the input buses being sent to the insert effects, the effects that are assigned, their on/off status, chaining, and the output bus that follows the insert effect.

Use the SAMPLING > IFX– Insert FX page to select insert effects, turn them on/off, and make chain settings.

8-1b: Bus Select

Bus Select (IFX/Indiv.Out Assign) (All OSCs to)

[L/R, IFX1...12, 1...4, 1/2...3/4, Off]

Selects the bus.

If you want to apply an effect to a sample (multisample) that you sampled or loaded, select IFX1–12. (“Resample” 0–8c)

Note: After you resample, L/R will automatically be selected as the “Bus Select (All OSCs to)” setting. These settings are made automatically so that the effect will not be applied again (i.e., a second time) when you play back the sample that was resampled with the IFX. (In the same way, the on/off settings for MFX1, 2 and TFX1, 2 will also be turned off.) Be aware of this if you want to sample once again.

8-1c: FX Control Bus

FX Control Bus [Off, 1, 2]

This sends the output of the oscillator (multisample) to a FX Control bus (stereo 2-channel; FX Ctrl1, 2)

Use the FX Control buses when you want to use a separate sound to control the input of an effect. You can use the two (stereo 2-channel) buses to control effects freely.

For more information, please see “FX Control Bus” on page 583.

8-1d: REC Bus

REC Bus (All OSCs to) [Off, 1...4, 1/2, 3/4]

This sends the output of the oscillator (multisample) to the REC buses (four mono channels; 1...4). If you want to resample from the REC buses, set **Source Bus** to REC1/2 or REC3/4.

The REC buses are used to sample in each mode, and to record audio tracks in SEQUENCER mode. They are dedicated buses for recording.

Off: The oscillator output will not be sent to the REC buses. Normally you will leave this Off.

1...4: The oscillator output will be sent in monaural to the corresponding REC bus.

1/2, 3/4: The oscillator output will be sent in stereo to the corresponding pair of REC buses.

8-1e: OSC MFX Send

Send1 (to MFX1) [000...127]

Send2 (to MFX1) [000...127]

This sets the send levels at which the output of the oscillator (multisample) is sent to the master effects. The master effects are sent to the L/R bus. Set the Source Bus to L/R if you want to use master effects while resampling.

MIDI You can use CC#93 to control the Send 1 level and CC#91 to control the Send 2 level. The global MIDI channel specified by **MIDI Channel** (GLOBAL 1-1a) is used for these messages.

8-1f: Tempo

♪ (Tempo) [040.00...300.00, EXT]

This is the Global tempo, as used for controlling effects, etc.

✓ 8-1: Page Menu Commands

- Copy Insert Effect →p.122
- Swap Insert Effect →p.123

- PAGE →p.126
- MODE →p.126

8-5: Insert FX



In this page you can select the effect types for the insert effects, turn them on/off, and make chaining settings.

8-5a: IFX

Here you can select the type of effect for each insert effect 1–12, turn it on/off, make chaining settings, and make post-IFX mixer settings. For insert effects, the direct (Dry) sound is always stereo-in/out. The configuration of the effect sound (Wet) will depend on the type of effect.

Meters below the IFX labels display the effect output levels in realtime, showing the combined peak signals of the left and right channels.

IFX1

IFX1 [000...197]

This selects the effect type for insert effect 1.

Category/IFX Select menu

When you press the popup button, the Category/IFX Select menu will appear, letting you select effects by category. Use the tabs to select a category, and then select an effect within that category. Press the OK button to execute your selection, or press the Cancel button to cancel.

IFX1 On/Off [Off, On]

Switches the insert effect on/off.

If this is off, the input will simply be passed to the output. (Turning on 000:No Effect is the same as the Off setting.)

The setting will alternate between on and off each time you press this.

MIDI Separately from this setting, you can use control change #92 to turn all insert effects off. A value of 0 turns them off, and values of 1–127 restore the original setting. The global MIDI channel specified by **MIDI Channel** is used for this message.

Chain to [IFX2...IFX12]

You can chain up to twelve insert effects together in series, to create more complex effects. Set up the chain using this parameter, and then enable it using the **Chain** check box, below.

Effects must be chained in ascending numeric order. For example, IFX1 can be chained to any of IFX2 through IFX12, and IFX2 can be chained to IFX3 through IFX12.

Chain [Off, On]

This connects the insert effects in series.

If the Chain checkbox is selected, the insert effect will be connected in series to the insert effects configured in “Chain to”.

Example: IFX1 “Chain to”: IFX2
IFX1 “Chain”: On

Connects the IFX1 → IFX2 in series. Setting “Bus Select” (8-1b) to “IFX1” will insert the effects for the OSC output in series, with the IFX1 first and then IFX2. You can connect a maximum of 12 insert effects in series (from IFX1 to IFX12). When the insert effects are chained, the settings after passing through the final IFX will be enabled, including “Pan (CC#8)”, “Bus Select”, “REC Bus”, “Send1” and “Send2”.

Pan (CC#8) (Post IFX PanCC#8) [L000...C064...R127]

Specifies the panning immediately after the insert effect.

MIDI You can use CC#8 to control this.

Bus Sel. (Bus Select) [L/R, 1...4, 1/2...3/4, Off]

Specifies the bus to which the signal will be sent immediately after the insert effect.

L/R: The signal will be output to the L/R bus. Then after passing through TFX1 and TFX2, it will be output to AUDIO OUTPUT L/R. This is the normal setting.

1...4: The signal will be output in monaural to the selected AUDIO OUTPUT (INDIVIDUAL).

1/2...3/4: The signal will be panned by the “Pan (CC#8)” setting and sent in stereo to the selected AUDIO OUTPUT (INDIVIDUAL) pair.

Off: The signal will not be sent directly to the L/R or Individual buses. Use this setting if you want to apply **Send1** and **Send2** and then send the signal directly to the master effects.

FX Control Bus [Off, 1, 2]

Sends the post-IFX signal to the FX Control buses. See “8-1d: REC Bus” on page 596.

REC Bus [Off, 1...4, 1/2, 3/4]

Sends the post-IFX signal to the REC buses. See “8-1d: REC Bus” on page 596. If you want to resample via the REC buses, set **Source Bus** (0-8c) to REC 1/2 or REC 3/4.

Send1 [000...127]

Send2 [000...127]

These adjust the level at which the post-IFX signal is sent to master effects 1 and 2. This is valid if **Bus Select** (8-5a) is set to L/R or Off.

MIDI You can use CC#93 to control the Send 1 level, and CC#91 to control the Send 2 level. The global MIDI channel specified by **MIDI Channel** is used for these messages.

IFX2...12

Here you can specify each insert effect’s effect type, on/off status, chaining, and mixer settings following the insert effect. With the exception of **Chain to** and **Chain**, the parameters are the same as for IFX1. See “IFX1” on page 597.

IFX2: Chain to [IFX3...IFX12]

IFX3: Chain to [IFX4...IFX12]

IFX4: Chain to [IFX5...IFX12]

IFX5: Chain to [IFX6...IFX12]

IFX6: Chain to [IFX7...IFX12]

IFX7: Chain to [IFX8...IFX12]

IFX8: Chain to [IFX9...IFX12]

IFX9: Chain to [IFX10...IFX12]

IFX10: Chain to [IFX11...IFX12]

IFX11: Chain to [(IFX12)]

These specify the chain destination for each insert effect. If **Chain** (check box) is on, the insert effect will be connected in series to the IFX specified by the **Chain to** setting.

8-5b: Tempo

♪ (Tempo) [040.00...300.00, EXT]

This specifies the tempo. This setting is used for controlling effects, etc.

✓ 8-5: Page Menu Commands

- Copy Insert Effect →p.122
- Swap Insert Effect →p.123
- Insert IFX Slot →p.123
- Cut IFX Slot →p.124
- Clean Up IFX Routings →p.124
- PAGE →p.126
- MODE →p.126

8-7: IFX 1-12

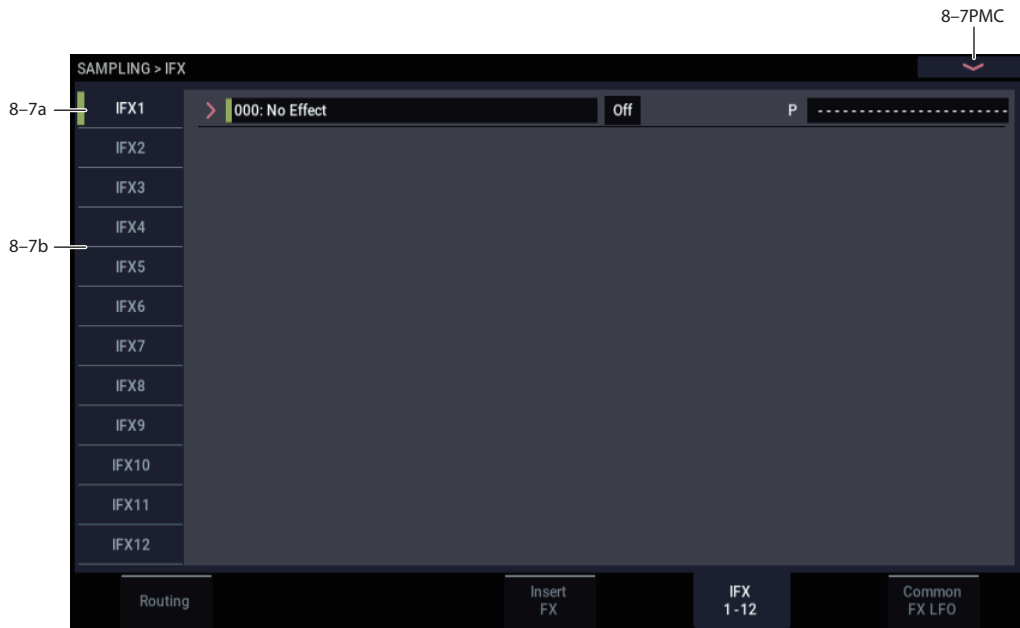

This page lets you edit the parameters of the insert effect 1. Use the tabs at left to select IFX1 through IFX12.

8-7a: IFX1

MIDI Effect dynamic modulation (Dmod) is controlled on the global **MIDI Channel** (GLOBAL 1-1a).

IFX Type

This selects the effect type for insert effect 1.

IFX1 On/Off **[Off, On]**

This turns the insert effect on/off. It is linked with the on/off setting in the Insert FX page.

P (Effect Preset)

[P00, P01...15, U00...15, -----]

This selects the effect preset.

For more information, please see “Effect preset function” on page 103.

IFX1 Parameters

Set the parameters for the effect type selected for insert effect 1.

For details on the insert effects, please see the “Effect Guide,” beginning on page 731.

8-7b: IFX2...12

This configures the parameters of insert effects 2-12.

The parameters for IFX2-IFX12 are the same as for IFX1. See “8-7a: IFX1,” above.

✓ 8-7: Page Menu Commands

- Copy Insert Effect →p.122
- Swap Insert Effect →p.123
- Write FX Preset →p.126

- PAGE →p.126
- MODE →p.126

8-9: Common FX LFO

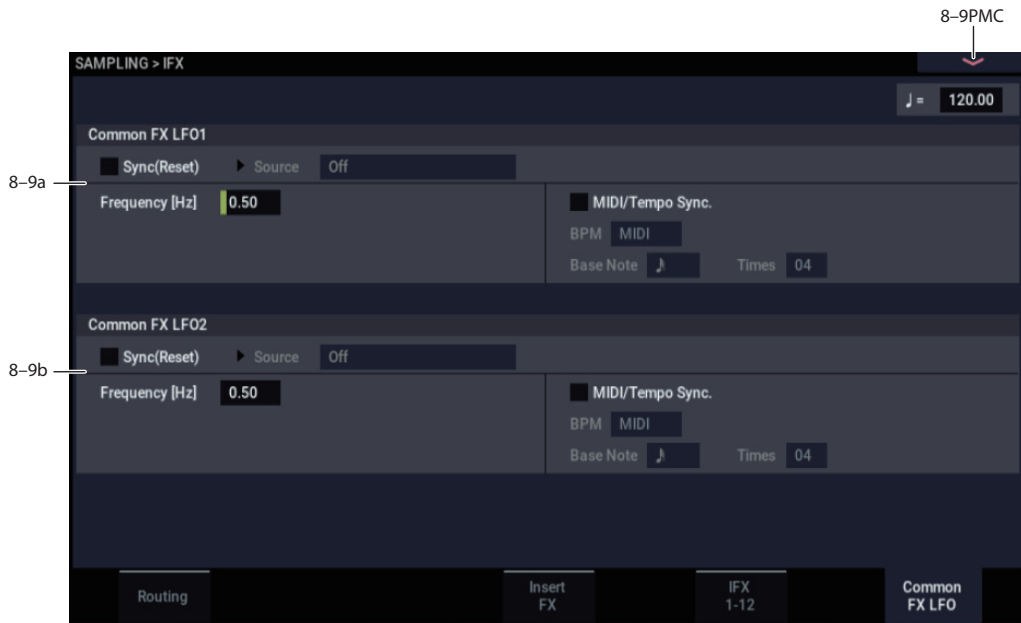

The two Common FX LFOs allow you to synchronize LFO-based modulation for multiple effects, such as phasers, flangers, filters, and so on.

The Common LFOs control only the frequency, MIDI synchronization, and reset options; each individual effect still has its own settings for the LFO waveform and phase.

Within the individual effects, you can choose whether to use one of the Common LFOs, or to use the individual effect's frequency, sync, and/or reset settings instead. This is done via the effect's **LFO Type** parameter; select **Individual** to use the effect's settings, or **Common 1** or **2** to use the Common LFOs.

MIDI Dmod (Dynamic Modulation) is controlled on the global MIDI channel specified in GLOBAL mode MIDI page.

♩ (Tempo) [040.00...300.00, EXT]

This specifies the tempo. This setting is used for controlling effects, etc.

8-9a: Common FX LFO1

Frequency [0.02...20.00 (Hz)]

Sync (Reset) [Off, On]

Src (Dmod Src) [List of Dmod Sources]

MIDI/Tempo Sync [Off, On]

BPM [MIDI, 040.00...300.00]

Base Note [♩... ♪]

Times [01...32]

These parameters are the same as in PROGRAM mode. See "8-9a: Common FX LFO1" on page 105.

8-9b: Common FX LFO2

The parameters are identical to those for Common FX LFO1.

✓ 8-9: Page Menu Commands

- Copy Insert Effect →p.122
- Swap Insert Effect →p.123
- PAGE →p.126
- MODE →p.126

SAMPLING > MFX/TFX

Here you can select the effect types for the master effects and total effects, and turn them on/off.

The master effects are output to the L/R bus. The total effects are inserted in the L/R bus. If you want to use these while sampling, set **Source Bus** to L/R.

For more information, please see the “Effect Guide,” beginning on page 731.

Note: When you sample, **MFX1 On/Off**, **MFX2 On/Off**, **TFX1 On/Off**, and **TFX2 On/Off** are automatically turned off. This is done so that the effect will not be applied again (i.e., a second time) when you play back the sample that was resampled with the MFX1/2 and TFX1/2. (In the same way, the **Bus Select (All OSCs to)** parameter will automatically be set to L/R.) Be aware of this if you want to sample again.

9-1: Routing

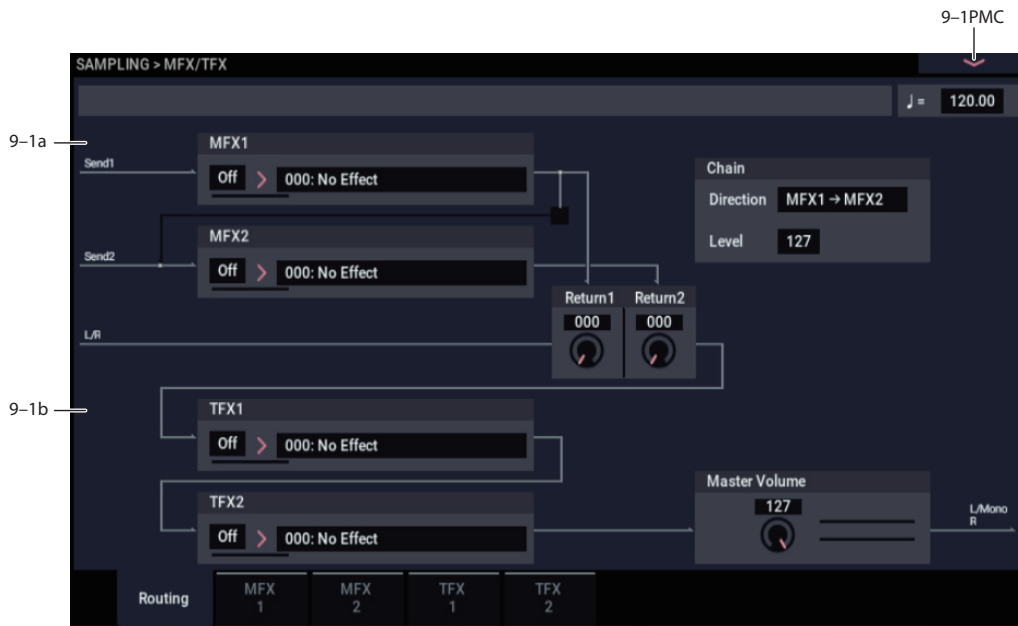

9-1a: MFX

The master effect does not output the direct sound (Dry). Adjust the **Return 1** and **Return 2** levels to return the signal to the L/R bus and mix it with the L/R bus signal.

The master effects are stereo-in/out, but depending on the selected effect type, the output may be monoaural. See “In/Out” on page 739.

The meters below the effects names display the effect output levels in realtime, showing the combined peak signals of the left and right channels.

MFX1

MFX1 [000...197]

This selects the effect type for master effect 1. Choose from 000:No Effect – 197: Rotary Speaker Pro CX Custom. If you choose 000:No Effect, the output from the master effect is muted.

Category/MFX Select menu

When you press the popup button, the Category/MFX Select menu will appear, letting you select effects by category. Use the tabs to select a category, and then select an effect within that category. Press the OK button to execute your selection, or press the Cancel button to cancel.

MFX1 On/Off

[Off, On]

Switches the master effects 1 on/off. When off, the output will be muted. This will alternate between on and off each time it is pressed.

MIDI Separately from the settings here, you can use control change #94 to turn master effects 1 and 2 off. A value of 0 turns them off, and values of 1–127 restore the original setting. The global MIDI channel specified by **MIDI Channel** (GLOBAL 1–1a) is used for this message.

Return 1

[000...127]

This specifies the return level from the master effect to the L/R bus (after which it passes through TFX1 and 2, and is sent from L/MONO and R).

MFX2

MFX2

[000...197]

MFX2 On/Off

[Off, On]

Return 2

[000...127]

These parameters specify the effect type for master effect 2, its on/off status, and the return level from master effect 2 to the L/R bus. See “MFX1” on page 601.

Chain

Chain On/Off [Off, On]

On (checked): Chain (series connection) will be turned on for MFX1 and MFX2.

Chain Direction [MFX1->MFX2, MFX2->MFX1]

Specifies the direction of the connection when MFX1 and MFX2 are chained.

MFX1→MFX2: Connect from MFX1 to MFX2.

MFX2→MFX1: Connect from MFX2 to MFX1.

Chain Level [000...127]

When chain is On, this sets the level at which the sound is sent from the first master effect to the next master effect.

9-1b: TFX1, 2

These are the parameters for total effect 1 and 2, which are placed at the final stage of the L/R bus. After passing through the total effects, the sound is output to AUDIO OUTPUT (MAIN OUT) L/MONO and R.

For the total effects, the direct sound (Dry) is always stereo-in/out. The input/output configuration of the effect sound (Wet) will depend on the selected effect type.

The total effects are stereo-in and stereo-out, but the output may be monaural depending on the type of effect you select.

TFX1

TFX1 [000...197]

This selects the effect type for total effect 1. Choose from 000:No Effect – 197: Rotary Speaker Pro CX Custom.

Category/TFX Select menu

When you press the popup button, the Category/TFX Select menu will appear, letting you choose effect types by category. Use the tabs to select an effect category, and then choose an effect within that category. Press the OK button to execute your choice, or press the Cancel button to cancel.

TFX1 On/Off [Off, On]

This turns total effect 1 on/off. If this is off, the input will be passed directly through. The setting will alternate between on/off each time you press this.

MIDI Separately from this setting, you can use control change #95 to turn both total effects off. A value of 0 turns them off, and values of 1–127 restore the original setting. The global MIDI channel specified by **MIDI Channel** (GLOBAL 1-1a) is used for this message.

TFX2

TFX2 [000...197]

TFX2 On/Off [Off, On]

These parameters specify the effect type and on/off status for total effect 2. See “TFX1,” above.

9-1c: Master Volume

Master Volume [000...127]

This controls the final volume level after total effects 1 and 2, as heard at AUDIO OUTPUT (MAIN OUT) L/MONO and R.

The stereo meter to the right of the volume control shows the audio levels at the main output in realtime, including clipping.

✓ 9-1: Page Menu Commands

- Copy MFX/TFX →p.125
- Swap MFX/TFX →p.125

- PAGE →p.126
- MODE →p.126

9-2: MFX1

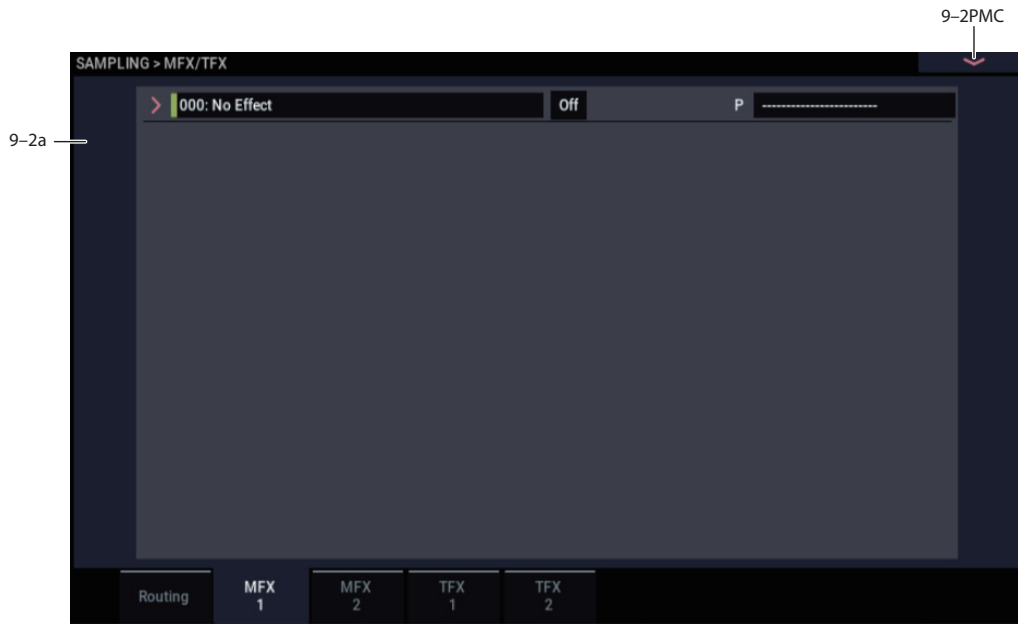

9-2a: MFX1

Here you can edit the parameters of the master effect 1.

MIDI Effect dynamic modulation (Dmod) is controlled on the global **MIDI Channel** (GLOBAL 1-1a).

MFX Type

This selects the effect type for master effect 1.

MFX1 On/Off [Off, On]

This turns master effect 1 on/off. It is linked with the on/off setting in the MFX/TFX- Master/Total Effect - Routing page.

P (Effect Preset) [P00, P01...15, U00...15, -----]

This selects the effect preset.

For more information, please see “Effect preset function” on page 103.

MFX1 Parameters

Here you can set the effect type parameters selected in the master effect 1.

For more information, please see “Master Effects (MFX1, 2)” on page 751.

✓ 9-2: Page Menu Commands

- Copy MFX/TFX →p.125
- Swap MFX/TFX →p.125
- Write FX Preset →p.126

- PAGE →p.126
- MODE →p.126

9-3: MFX2

9-4: TFX1

9-5: TFX2

These pages let you edit the parameters of Master Effect 2 and Total Effects 1 and 2. To select different effects types, use the Routing page, as described under “9-1: Routing” on page 601.

The parameters for MFX2, TFX1, and TFX2 are the same as for MFX1. For more information, see “9-2: MFX1” on page 603.

SAMPLING: Page Menu Commands

| | |
|---|--------|
| Delete Sample | →p.606 |
| Copy Sample | →p.606 |
| Rename Sample | →p.606 |
| Move Sample | →p.607 |
| Sample Mono To Stereo (Change Sample Type) | →p.607 |
| Delete MS (Delete Multisample) | →p.608 |
| Copy MS (Copy Multisample) | →p.608 |
| Rename MS (Rename Multisample) | →p.608 |
| Move MS (Move Multisample) | →p.608 |
| Convert MS To Program (Convert Multisample To Program) | →p.609 |
| MS Mono To Stereo/MS Stereo To Mono (Change Multisample Type) | →p.610 |
| Optimize RAM | →p.114 |
| Select Directory/File for Sample To Disk | →p.115 |
| Auto Sampling Setup | →p.611 |
| Truncate (for Sample Edit) | →p.613 |
| Cut | →p.614 |
| Clear | →p.614 |
| Copy | →p.615 |
| Insert | →p.615 |
| Mix | →p.615 |
| Paste | →p.616 |
| Insert Zero | →p.616 |
| Normalize/Level Adjust | →p.617 |
| Volume Ramp | →p.617 |
| Rate Convert | →p.618 |
| Reverse | →p.618 |
| Link | →p.619 |
| Truncate (for Loop Edit) | →p.620 |
| Time Slice | →p.620 |
| Time Stretch | →p.625 |
| Crossfade Loop | →p.629 |
| Pitch BPM Adjust | →p.629 |
| Copy Insert Effect | →p.122 |
| Swap Insert Effect | →p.123 |
| Insert IFX Slot | →p.123 |
| Cut IFX Slot | →p.124 |
| Clean Up IFX Routings | →p.124 |
| Copy MFX/TFX | →p.125 |
| Swap MFX/TFX | →p.125 |
| Write FX Preset | →p.126 |
| PAGE | →p.126 |
| MODE | →p.126 |

Remarks on editing stereo samples

- For stereo samples, the L channel and R channel samples are edited simultaneously. If you wish to edit only the L channel or R channel, select a mono multisample, and select either the L channel or R channel sample for editing.
- For stereo samples, the display will indicate “Save to No.(L)” and “(R).” These respectively specify the writing-destination sample numbers for the L and R channels.

• If you **Copy** a mono sample into the buffer, and then **Insert**, **Mix**, or **Paste** it to a stereo sample, the data will be inserted, mixed, or pasted into both the L and R sides. (The result is that a stereo sample will be created.)

If you **Copy** a stereo sample into the buffer, and then **Insert**, **Mix**, or **Paste** it to a mono sample, the L- and R-side data in the buffer will be mixed to mono, and then inserted, mixed, or pasted. (The result is that a mono sample will be created.)

You can also use these commands if you wish to monomix a stereo sample and use it as a mono sample. However, be aware that once a sample has been mixed to mono, it is no longer possible to return it to a stereo sample.

Start and End settings

When using the Sample Edit, **Truncate** – “Volume Ramp” and the Loop Edit, **Truncate** to edit the waveform data of a sample, you must first use **Start** and **End** to specify the region that you want to edit, and then select and execute a page menu command.

-  There is no compare function that lets you return the edited result to the state before editing. If you wish to preserve the unedited sample, uncheck the **Overwrite***1 item in the dialog box of each page menu command before you execute.

Note: To edit the **Start**, **Loop Start**, or **End** points, use Loop Edit.

If the above parameters are located within an area of sample addresses that are deleted or moved by your editing, they will automatically be moved.

-  The **Loop Start** and **End** (2–1d) must be at least eight samples apart. If you try to use the **Truncate**, **Cut**, or **Rate Convert** commands, but the results of the commands would cause the **Loop Start** and **End** to be separated by less than eight samples, you’ll see the error message “Sample length is shorter than minimum.” Please set the **Start** and **End** appropriately.

About Overwrite

When **Overwrite** is **unchecked**: When the command is executed, the edited sample will be saved in a different sample number. The unedited sample will remain without change.

When **Overwrite** is **checked**: When the command is executed, the edited sample will be overwritten onto the original sample (number). The original sample will be modified.

Note: Normally, you will leave “Save to No.” at its default setting, and execute without checking **Overwrite**. When you execute, both the data before and after editing will be preserved, and the sample number of the edited data will be assigned as the sample of that index.

Delete Sample

This command deletes all samples, the currently selected sample, or unused samples (samples not mapped to a multisample).

1. Select “Delete Sample” to open the dialog box.

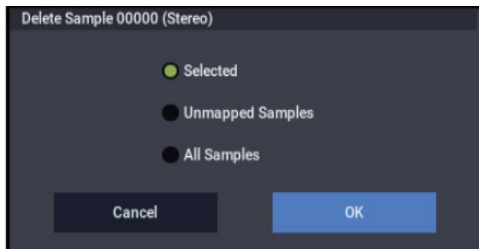

2. Use the radio buttons to specify which samples will be deleted.

Selected: The currently selected sample will be deleted. The sample assignment for **Index** (0–1b) will change to **---No Assign---**.

Unmapped Samples: All samples that are not mapped (used) in a multisample or drum kit will be deleted.

All Samples: All samples in memory will be deleted. The sample assignments of all multisamples will change to **---No Assign---**.

3. To execute the Delete Sample command, press the OK button. To cancel, press the Cancel button.

 If the sample data (waveform data) of the sample you delete is being used by another sample, the sample data itself will not be deleted. Only the sample will be deleted.

Copy Sample

This command copies the currently selected sample to another sample.

Note: The copy destination sample number will automatically be included in the resulting sample name. If necessary, use the **Rename Sample** menu command to rename it. When doing so, make sure that the name is not identical to any other sample name. For more information, please see “About stereo multisamples and stereo samples” on page 576.

1. Use Sample Select (0–1b) to select the copy-source sample.
2. Select Copy Sample to open the dialog box.

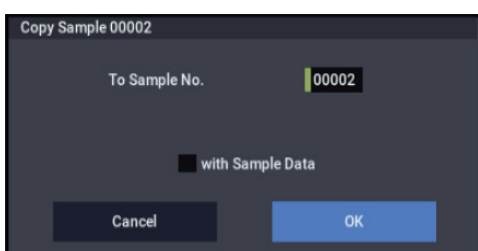

3. Specify the sample number of the copy destination.

STEREO When copying a stereo sample, specify both the L and R channels for the copy destination sample number.

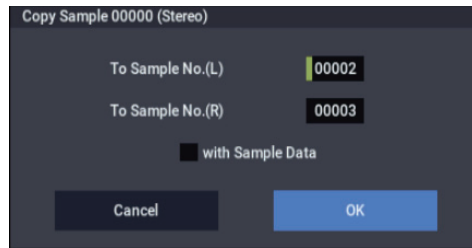

4. If you check “with Sample Data”: Executing the copy will simultaneously copy the sample data (waveform data) as well.

The copy source and copy destination samples will exist as completely independent samples. For example, you would use this when you wish to start with the same sample data, and edit it separately in Sample Edit to create two or more different types of sample.

If you do **not check** “with Sample Data”: Executing the copy will not copy the sample data (waveform data). The newly created sample will share the sample data of the copy source sample. For example, you would use this when you wish to use Loop Edit to create two or more versions of the same sample data with different loop addresses. Sample memory area will not be consumed by this type of copy. If you use Sample Edit to edit the sample data, the results will affect all samples that share this sample data.

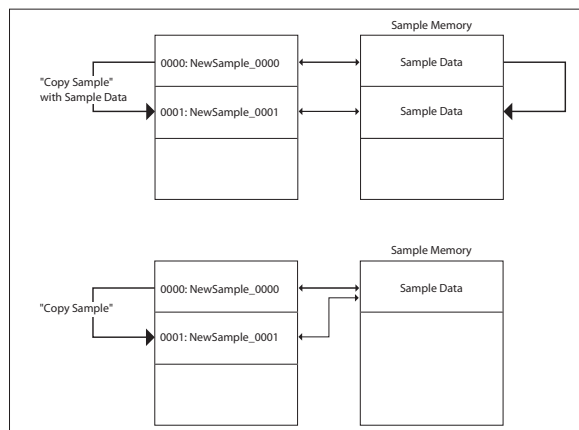

5. To execute the Copy Sample command, press the OK button. To cancel, press the Cancel button.

Rename Sample

This command lets you modify the name of the currently selected sample.

1. Use Sample Select (0–1b) to select the sample whose name you want to edit.
2. Select Rename Sample to open the dialog box.

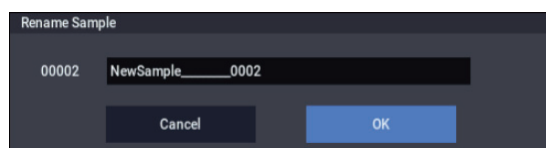

3. Press the text edit button to open the text edit dialog box, and set the name as desired (up to 24 characters).

If a USB QWERTY keyboard (commercially available) is connected, you can use this to enter text instead of the on-screen keyboard. For more information, see “Editing names and entering text” on page 206 of the OG.

STEREO If the multisample is stereo and a stereo sample is selected, you can input up to 22 characters for the sample name. This is because the last two characters are reserved for -L and -R. If you rename up to 22 characters of the sample of either the L or the R channel, the other sample will automatically be renamed.

4. To execute the Rename Sample command, press the OK button. To cancel, press the Cancel button.

Move Sample

This command lets you move the currently selected sample to the specified number (i.e., to change the sample number), or to rearrange the sample numbers so that they start from 00000 after samples have become discontinuous as a result of creating or editing. (See diagram below)

When you reassign the sample numbers, the sample numbers within the multisamples and drum kits (according to the setting of step 4) that use these sample will also be automatically reassigned. (This means that the samples of the multisamples and drum kits need not be reassigned following this operation.)

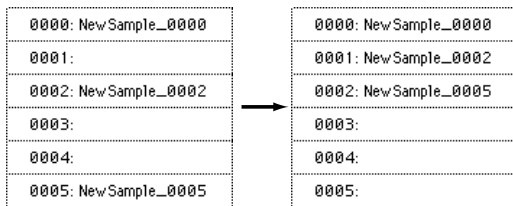

1. Use Sample Select (0–1b) to select the copy source sample.
2. Select “Move Sample” to open the dialog box.

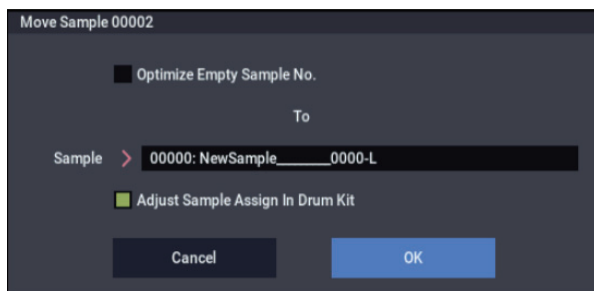

3. Use To Sample to specify the move destination sample number.

STEREO When moving a stereo sample, you must move the samples individually.

If you wish to reassign (pack) all sample numbers starting at 0000, check **Optimize Empty Sample No.**

4. If “Adjust Sample Assign in Drum Kit” is checked, and if the samples being moved are mapped to (used by) a drum kit, those sample numbers will also be automatically modified. Normally you will leave this checked.

Samples mapped to (used by) multisamples will be automatically changed to the new sample numbers regardless of this setting.

5. To execute the Move Sample operation, press the OK button. To cancel without executing, press the Cancel button.

Example) If data already exists at the move destination sample number, the sample will not be overwritten; instead, all subsequent samples will be renumbered upward.

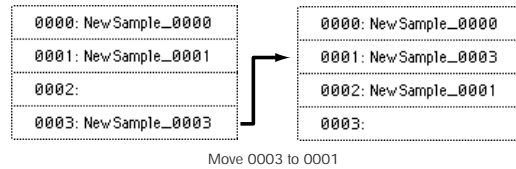

Example) If there is no empty sample number and forward movement is not possible, samples will be renumbered downward.

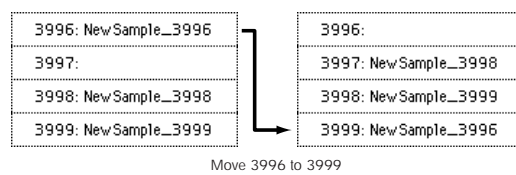

Sample Mono To Stereo (Change Sample Type)

This command converts a mono sample to stereo. This can be executed when a mono sample is selected.

1. Use Sample Select (0–1b) to select the sample that you want to change to stereo.
2. Select Sample Mono To Stereo to open the dialog box.

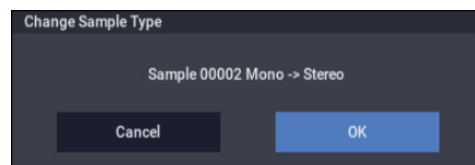

3. To execute the Change Sample Type command, press the OK button. To cancel, press the Cancel button.

When you execute this command, the sample type will change as follows.

- The selected sample will be changed to stereo. The last two characters of the sample name will be overwritten as “-L”.
- A new sample will be created with the same name except that the last two characters of the sample name will be “-R”.
- Also, if the selected multisample is mono, it will change to stereo.
- The last two characters of the multisample name will be overwritten as “-L”.
- A new multisample will be created with the same name, but whose last two characters are “-R”.
- The stereo sample that was created will be assigned automatically.

Delete MS (Delete Multisample)

This command deletes the currently selected multisample or all multisamples.

1. Use **Multisample Select (MS) (0–1a)** to select the multisample that you want to delete.
2. Select **“Delete MS”** to open the dialog box.

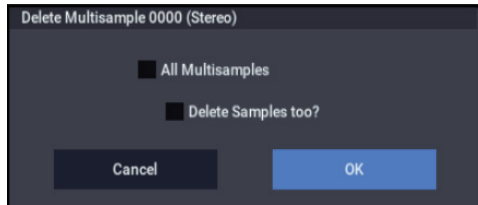

3. **All Multisamples:** Check this if you wish to delete all multisamples.
4. **Delete Samples too?:** Check this if you also wish to delete the samples included in the deleted multisample(s).

However, samples that are mapped to (used by) other multisamples or drum kits will not be deleted.

5. To execute the **Delete Multisample** command, press the **OK** button. To cancel, press the **Cancel** button.

 Even if you also choose to delete the samples that are included in the deleted multisample(s), any sample data (waveform data) used by these samples that is shared with other samples will not be deleted. Only the sample itself will be deleted.

Copy MS (Copy Multisample)

This command copies the selected multisample to another multisample.

Note: The copy destination multisample number will automatically be included in the resulting multisample name. If necessary, use the **Rename MS** menu command to rename it. When doing so, make sure that the name is not identical to any other multisample name. For more information, please see “About stereo multisamples and stereo samples” on page 576.

1. Use **Multisample Select (MS) (0–1a)** to select the copy-source multisample.
2. Select **Copy MS** to open the dialog box.

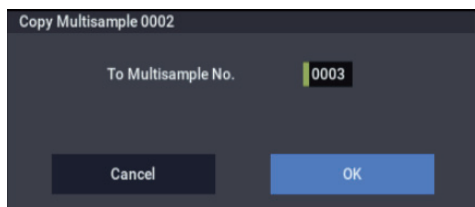

3. Specify the copy destination multisample number.

STEREO When copying a stereo multisample, copy both the L and R channels of the copy destination multisample number.

4. To execute the **Copy Multisample** command, press the **OK** button. To cancel, press the **Cancel** button.

 When a multisample is copied, the samples assigned to the multisample will also be copied at the same time. At this time, they will be automatically copied to vacant

sample numbers. The sample data (waveform data) will be shared between the copy source and copy destination. (Additional sample memory area will not be consumed.)

Rename MS (Rename Multisample)

This command modifies the name of the currently selected multisample.

1. Use **Multisample Select (MS) (0–1a)** to select the multisample whose name you want to edit.
2. Select **Rename MS** to open the dialog box.

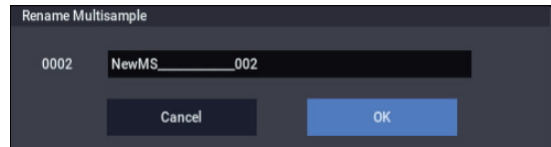

3. Press the text edit button to open the text edit dialog box, and set the name as desired (up to 24 characters).

If a USB QWERTY keyboard (commercially available) is connected, you can use this to enter text instead of the on-screen keyboard. For more information, see “Editing names and entering text” on page 206 of the OG.

STEREO If the selected multisample is stereo, up to 22 characters can be input as the multisample name. This is because the last two characters are reserved for -L and -R. If you rename up to 22 characters of the multisample of either the L or the R channel, the other multisample name will automatically be renamed.

4. To execute the **Rename Multisample** command, press the **OK** button. To cancel, press the **Cancel** button.

Move MS (Move Multisample)

This command lets you move the currently selected multisample to the specified number (i.e., to change the multisample number), or to rearrange the multisample numbers so that they start from 000 after multisamples have become discontinuous as a result of creating or editing. (See diagram below)

When you reassign the multisample numbers, the multisample numbers within the programs that use these multisamples will also be automatically reassigned (according to the setting of step 4). (This means that you do not need to reselect the multisamples in PROGRAM mode following this operation.)

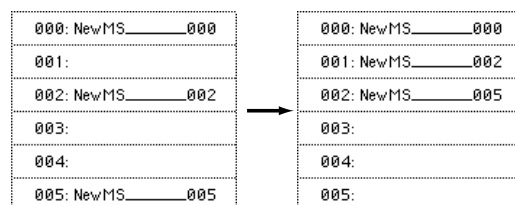

1. Use **Multisample Select (MS) (0–1a)** to select the multisample that you wish to move.
2. Select **“Move MS”** to open the dialog box.

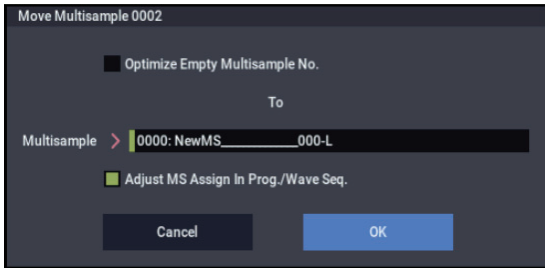

3. In **To Multisample**, specify the move destination multisample number.

STEREO When moving a stereo multisample, you will need to move each part separately.

If you wish to rearrange all multisamples consecutively, check “Optimize Empty Multisample No.”

4. If **Adjust Multisample Assign in Program** is checked and if the multisamples being moved are used in programs, the multisample numbers of the programs will also be reassigned automatically. Normally you will leave this checked.

5. To execute the **Move Multisample** command, click the **OK** button. If you decide not to execute, click the **Cancel** button.

Example: If data already exists at the move destination multisample number, the multisample will not be overwritten; instead, all subsequent multisamples will be renumbered upward.

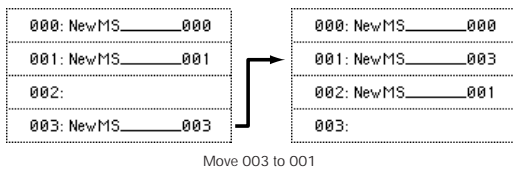

Example: If there is no empty multisample number and forward movement is not possible, multisamples will be renumbered downward.



Convert MS To Program (Convert Multisample To Program)

This command converts the selected multisample into a program.

If you have recorded a sample or created a multisample and would like to play it in PROGRAM mode, COMBINATION mode, or SEQUENCER mode, you must create a program that uses that multisample for its oscillator.

If you’ve created a multisample in SAMPLING mode and want to use it as a program, go to Program P2: OSC Pitch and set the OSC1 Multisample/Wave Sequence and OSC2 Multisample/Wave Sequence “Bank” parameters (if “Type” = Multisample) to RAM Mono or RAM Stereo. A multisample that you created in SAMPLING mode can be used in the program, and then to make program settings to specify how the multisample will be sounded.

However by executing the **Convert MS To Program** command, you can quickly and easily convert the SAMPLING mode settings into a new program, without having to make any PROGRAM mode settings as described above.

1. Use **Multisample Select (MS) (0–1a)** to select the multisample that you want to convert to a program.
2. Select **Convert MS To Program** to open the dialog box.

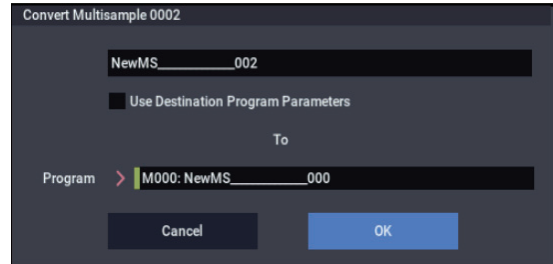

3. Press the text edit button to open the text edit dialog box, and set the Program name as desired (up to 24 characters).

By default, the multisample name will be used.

If a USB QWERTY keyboard (commercially available) is connected, you can use this to enter text instead of the on-screen keyboard. For more information, see “Editing names and entering text” on page 206 of the OG.

4. If **Use Destination Program Parameters** is unchecked:

Executing the command will replace the multisample of the convert destination program with the multisample selected here, and will initialize the remaining program parameters.

The multisample will be converted into a single-oscillator Program.

If **Use Destination Program Parameters** is checked:

Executing this command will replace the multisample of the destination program with the multisample selected here, and will not initialize the remaining program parameters. Use this setting if you wish to use the parameter settings of an existing preset program, etc.

Note: **Use Destination Program Parameters** requires that the **Oscillator Mode** of the destination program be Single. If it is a Double or Drum program, the message “Oscillator Mode conflicts” will appear.

5. In **To Program**, select the convert destination program.

When the edit cell is selected, you can use the VALUE dial, and +/- buttons to make a selection. When you press the popup button, the Program Select menu will appear. Here you can select a program by bank.

6. To execute the **Convert Multisample To Program** command, press the **OK** button. To cancel, press the **Cancel** button.

MS Mono To Stereo/MS Stereo To Mono (Change Multisample Type)

This command converts a mono multisample to stereo, or a stereo multisample to mono. If the selected multisample is mono, the dialog box will allow you to execute **MS Mono To Stereo**. If the selected multisample is stereo, the dialog box will allow you to execute **MS Stereo To Mono**.

1. Use **Multisample Select (MS) (0–1a)** to select the multisample that you want to change to stereo or mono.
2. Choose either **MS Mono To Stereo** or **MS Stereo To Mono** to open the dialog box.

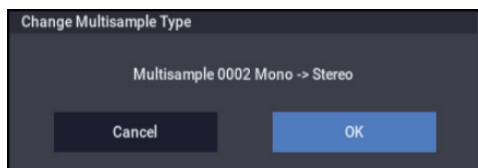

3. To execute the **Change Multisample Type** command, press the **OK** button. To cancel, press the **Cancel** button.

When you execute this command, the multisample type and sample assignment will change as follows.

MS Mono To Stereo

- The selected multisample will be converted to stereo. The last two characters of the multisample name will be overwritten as -L.
- An identical multisample will be newly created, but with the last two characters of the multisample name overwritten as -R.
- Mono samples assigned to the original multisample will be assigned to both -L and -R multisamples.
- If samples assigned to the original multisample are part of a stereo pair of samples, the -L and -R samples will be assigned to the -L and -R multisamples.

STEREO : MS Stereo To Mono

- The selected multisample will be converted to mono. The -L or -R at the end of the multisample name will be deleted.
- Multisamples that are stereo pairs of the selected multisample will be deleted.

Optimize RAM

This command optimizes the RAM memory for SAMPLING mode.

When you execute the optimize command, any memory areas containing unused data will be rearranged, allowing you to utilize all of the remaining memory.

If you run out of memory, try using **Optimize RAM**.

The remaining amount of RAM can be checked under “0–1f: Free Sample Memory/Locations,” as described on page 579.

1. Select **Optimize RAM** to open the dialog box.

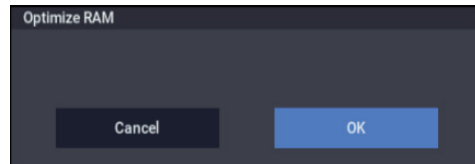

2. Press the **OK** button to execute the optimize command, or press the **Cancel** button to cancel without executing.

Note: If **Auto Optimize RAM** (GLOBAL 0–1d) is checked, RAM will be optimized automatically.

Select Directory/File for Sample to Disk

This command is available only when the Sampling Setup’s **Save To** parameter is set to Disk. It lets you set the disk, directory, and name for the WAVE file created by sampling. It also lets you audition WAVE files directly from drive, without needing to switch to MEDIA mode.

Specifying the WAVE file’s drive, directory, and name

1. Choose **Select Directory/File for Sample to Disk** to open the dialog box.

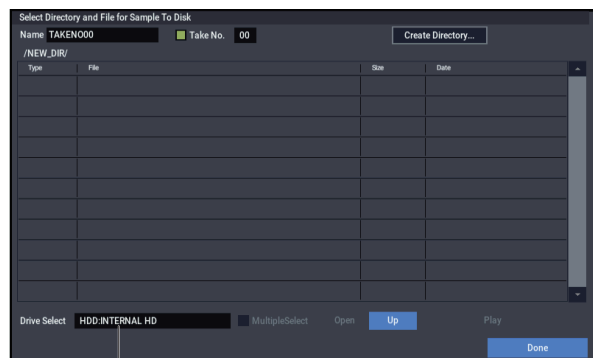

2. Use **Drive Select** to choose a drive to record onto.

You can record to either an internal drive or a USB storage device

3. Use the **Open** button and **Up** button to move between directories.

4. In the **Name** field, specify a name for the WAVE file.

If you check **Take No.**, a two digit “take number” will be added at the end of the filename when it is saved. The number will automatically increment each time you sample. When sampling repeatedly, this is convenient since it ensures that each file will be saved with a different filename.

5. Press the **Done** button to complete the settings.

Playing back a WAVE file

Once recorded, you can audition the sample directly from the **Select Directory/File for Sample to Disk** window; just select the file and press the **Play** button, as described below.

1. Choose **Select Directory/File for Sample to Disk** to open the dialog box.
2. Use **Drive Select**, the **Open** button, and the **Up** button to select a directory on drive, and then select the WAVE file that you want to play.

Note: Only 16-bit or 24-bit, 44.1kHz or 48kHz WAVE files are supported. Other bit depths and sampling rates are not supported.

3. Press the SAMPLING START/STOP button or the on-screen Play button.

The selected WAVE file will play.

4. To stop playback, either press the SAMPLING START/STOP button again, or touch the on-screen Stop button.

 If the WAVE file is mono, the same sound will be output to L and R.

Auto Sampling Setup

This command automatically sets various sampling-related parameters for SAMPLING mode operations. You can use this command when you want to sample an external audio source, or when you want to apply an effect to a sample and resample it. You can also use this command to initialize the settings.

 When you execute this command, the applicable parameters will be set automatically. You cannot use the page menu command “Compare” to recall the previous settings.

 The settings are automatically made for the most typical applications. After executing the auto setup operation, you can further adjust any of the settings to suit your needs as described below.

1. Select Auto Sampling Setup to open the dialog box.

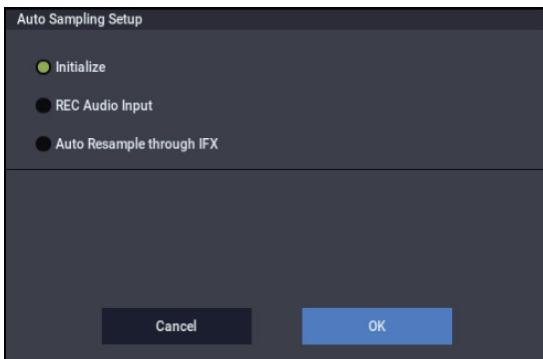

2. Use the radio buttons to select the type of settings you want to make.

Initialize: Initialize the sampling-related parameters to their default values.

REC Audio Input: Make settings for sampling an external audio source.

Auto Resample through IFX: Make settings for applying an effect to a sample and resampling it.

3. Make additional settings as desired, as described below.

The available settings will depend on whether you’ve selected Initialize, REC Audio Input, or Auto Resample through IFX.

Initialize

If you select Initialize:

1. Press the OK button to initialize the settings, or press the Cancel button if you decide not to execute. For more information, please see “Auto Sampling Setup:

Automatically-set parameters and their values” on page 613.

REC Audio Input

If you select REC Audio Input:

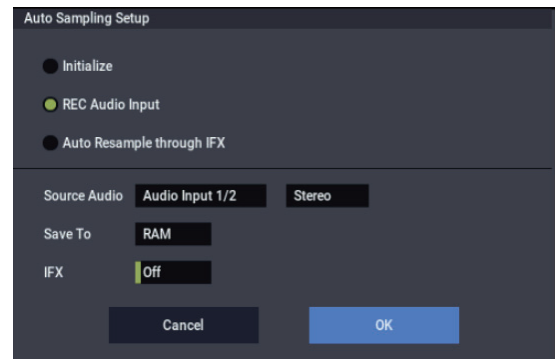

1. Use “Source Audio” to select the external audio input source.

Audio Input 1/2: These are the analog audio inputs, for either microphones or line-level signals.

USB 1/2: These are the USB audio inputs, for sampling from a connected computer.

2. Use “Mono-L/Mono-R/Stereo” to select the input source, and either mono or stereo as the number of channels that will be sampled.

Mono-L: Settings will be made to sample only the left input.

Mono-R: Settings will be made to sample only the right input

Stereo: Settings will be made for sampling in stereo.

3. Use “Save to” to specify the destination to which the sampled data will be written. RAM writes the data into SAMPLING mode. DISK creates a Wave file from the sampled data and saves it to drive.

4. If you want to apply an insert effect to the external audio input source while it is being sampled, use “IFX” to specify the insert effect that you want to use. If you don’t want to use an insert effect, set this Off.

5. Press the OK button to execute the REC Audio Input command, or press the Cancel button if you decide not to execute.

For more information, please see “Auto Sampling Setup: Automatically-set parameters and their values” on page 613.

Note: When you are ready to sample (after executing REC Audio Input), press the SAMPLING REC button and then the SAMPLING START/STOP button to begin sampling. (This is because **Trigger** is set to Sampling START button.) When you’ve finished performing, press the SAMPLING START/STOP button to stop sampling.

Note: Here’s how to check the data you just sampled.

If you specified **Save to RAM**, play the C2 note of the keyboard to hear the sample. If you specified **Save to DISK**, use the menu command **Select Directory/File for Sample to Disk** to hear the sample.

Note: If you specified **Save to DISK** and want to change the save-destination for the Wave files, use the menu command **Select Directory/File for Sample to Disk**.

Note: If you want to change the way in which sampling is initiated, change the **Trigger** setting.

Auto Resample through IFX

If you select Auto Resample through IFX:

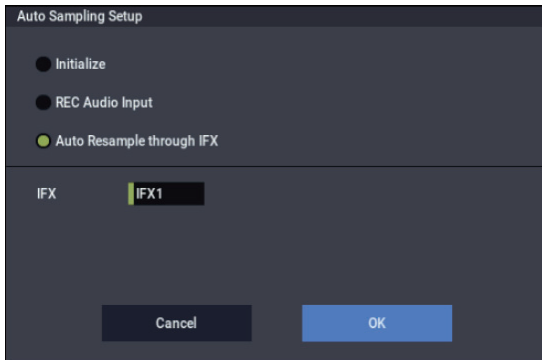

1. Use “IFX” to select the effect that you want to apply to the sample.
2. Press the OK button to execute Auto Sampling Setup (Auto Resample through IFX), or press the Cancel button if you decide not to execute. For more information, please see “Auto Sampling Setup: Automatically-set parameters and their values” on page 613.

When you are ready to resample (after executing Auto Resample through IFX), perform the following steps.

3. Use Key (0–8c) to specify the key to which the sample you want to resample is assigned.
4. Use IFX– Insert Effect to make effect settings. To hear the sound, play the note you specified in Key.
5. To begin resampling, press the SAMPLING REC button and then the SAMPLING START/STOP button. (This is because Trigger is set to Sampling START button.) The sample will play, and when playback ends, it will be resampled.

To check the resampled data, play the note you specified in the **Key** parameter.

- ⚠ To prevent the insert effect from being applied a second time when you listen to the resampled data, “Bus Select All OSCs to” (8–1b) will automatically be set to L/R when resampling is complete. If you want to apply IFX and resample once again, you will need to change this setting back to the same IFX.

Auto Sampling Setup: Automatically-set parameters and their values

| | | [Initialize] | [REC Audio Input] | [Auto Resampling through IFX] |
|------------------------------------|--------------------------|------------------------|------------------------------|-------------------------------|
| Input (Input Source)* ¹ | | Input 1 & 2, USB 1 & 2 | [Source Audio]* ² | Input 1 & 2, USB 1 & 2 |
| Input1, USB 1 | Bus Select | Off | [IFX]* ³ | Off |
| | FX Ctrl Bus | Off | Off | Off |
| | REC Bus | Off | Off | Off |
| | Send1/2 | 000 | 000 | 000 |
| | Pan | L000 | L000 | L000 |
| | Level | 127 | 127 | 127 |
| Input2, USB 2 | Bus Select | Off | [IFX]* ³ | Off |
| | FX Ctrl Bus | Off | Off | Off |
| | REC Bus | Off | Off | Off |
| | Send1/2 | 000 | 000 | 000 |
| | Pan | R127 | R127 | R127 |
| | Level | 127 | 127 | 127 |
| Sampling Setup (Name) | Source Bus | L/R | L/R | L/R |
| | Source Direct Solo | (N/A) | (N/A) | (N/A) |
| | Trigger | Sampling START button | Sampling START button | Sampling START button |
| | Metronome Precount | (N/A) | (N/A) | (N/A) |
| | Pre Trigger REC | – | – | – |
| | Resample | Manual | Manual | Auto |
| REC Sample Setup | Save to | RAM | [Save to] | RAM |
| | Mode | Stereo | [Source Audio]* ⁴ | Stereo |
| | Rec Level | +0.0 | +0.0 | +0.0 |
| | Auto +12dB On | On | On* ⁵ | On |
| | Auto Loop On | On | – | – |
| Select Directly | – | – | – | – |
| Routing | Bus Select (All OSCs to) | L/R | – | [IFX] |
| | FX Ctrl Bus | Off | – | Off |
| | REC Bus | Off | – | Off |
| | Send1/2 | 127 | – | 000 |
| Insert FX | Bus Select (Post IFX) | – | L/R* ⁶ | L/R* ⁶ |

–: Not set automatically

[]: Set automatically according to the parameter settings in the dialog box

*1 Edit SAMPLING mode parameters

*2 Uses the input source specified as Source Audio.

*3: If IFX is Off this will be L/R. If IFX1...12 is selected this will be IFX1...12.

*4 L-Mono if the Source Audio is Mono-L, R-Mono if it is Mono-R, and Stereo if it is Stereo

*5 When Save to=RAM

*6 Specify the BUS Select of that IFX1...12. If effects are chained, specify the last IFX in the chain.

Truncate (for Sample Edit)

This command deletes unwanted data that lies outside the **Start** and **End** points. Use this command when you wish to delete silence at the beginning or end of the sample.

Note: If you wish to delete unneeded (unplayed) sample data after setting the **Start**, **Loop Start**, and **End** (2–1d), use the “Truncate (for Loop Edit)” page menu command found in Loop Edit.

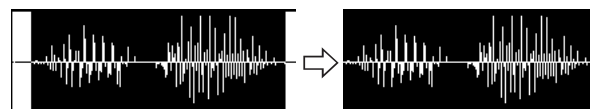

1. Use Sample Select (1–1b) to select the sample that you wish to edit, and use Start and End to specify the editing range.

You can press the Play button to hear the portion that will be left by the **Truncate** command.

2. Select Truncate to open the dialog box.

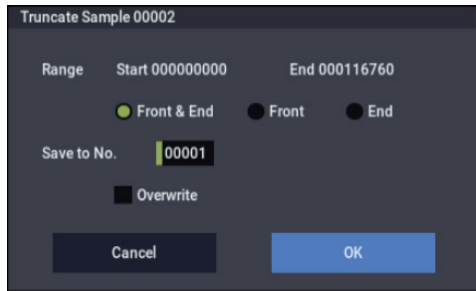

3. The editing range will be shown in Range Start and End.
4. Use the radio buttons to select the portion that will be deleted.

Front & End: The sample data that lies before the **Start** and after the **End** will be deleted.

Front: The sample data that lies before the **Start** will be deleted.

End: The sample data that lies after the **End** will be deleted.

5. In **Save to No.**, specify the save destination sample number.

By default, an unused sample number will be selected.

If **Overwrite** is checked, the sample number will be fixed to the current sample, and cannot be changed. See “About Overwrite” on page 605.

STEREO For stereo samples, use “Save to No.(L)” and “(R)” to specify the save-destination of the L and R channels.

6. To execute the **Truncate** command, press the **OK** button. To cancel, press the **Cancel** button.

Cut

This command deletes the data between the **Start** and **End** points. Sample data located after the deleted portion will be moved toward the beginning of the sample.

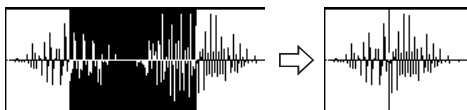

1. Use **Sample Select (1–1b)** to select the sample that you wish to edit, and use **Start** and **End** to specify the editing range.
You can press the **SAMPLING START/STOP** button or **Play** button to hear the portion that will be deleted by the **Cut** command.
2. Select **Cut** to open the dialog box.

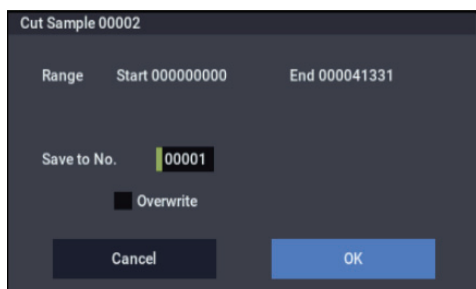

3. The range to be edited is shown by **Range Start** and **End**.
4. In **Save to No.**, specify the save destination sample number. By default, an unused sample number will be selected.

If **Overwrite** is checked, the sample number will be fixed to the current sample, and cannot be changed. See “About Overwrite” on page 605.

STEREO For stereo samples, use “Save to No.(L)” and “(R)” to specify the save-destination of the L and R channels.

5. To execute the **Cut** command, press the **OK** button. To cancel, press the **Cancel** button.

Clear

This command converts the data between the **Start** and **End** points to zero values. Sample data before and after the edited range will not move.

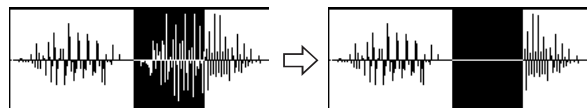

1. Use **Sample Select (1–1b)** to select the sample that you wish to edit, and use **Start** and **End** to specify the editing range.

You can press the **SAMPLING START/STOP** button or **Play** button to hear the portion that will be changed to zero-level by the “Clear” command.

2. Select “Clear” to open the dialog box.

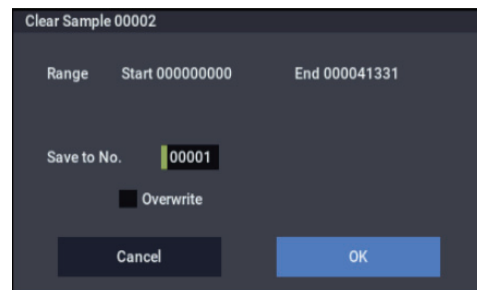

3. The range to be edited is shown by **Range Start** and **End**.
4. In **Save to No.**, specify the save destination sample number. By default, an unused sample number will be selected.

If **Overwrite** is checked, the sample number will be fixed to the current sample, and cannot be changed. See “About Overwrite” on page 605.

STEREO For stereo samples, use “Save to No.(L)” and “(R)” to specify the save-destination of the L and R channels.

5. To execute the **Clear** command, press the **OK** button. To cancel, press the **Cancel** button.

Copy

This command copies the sample data from the area between the **Start** and **End** points into the sample data buffer. This data can then be used by the **Insert**, **Mix**, or **Paste** commands.

- When you execute **Copy**, the data that is copied into the buffer actually consists only of the source sample number and the **Start** and **End** locations—not the data itself. Do not delete the source sample until you finish executing the **Insert**, **Mix**, or **Paste** command.

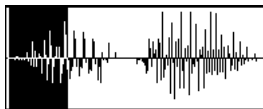

1. Use **Sample Select (1–1b)** to select the sample that you wish to edit, and use **Start** and **End** to specify the editing range.

You can press the SAMPLING START/STOP button or Play button to hear the portion that will be copied by the **Copy** command.

2. Select **Copy** to open the dialog box.

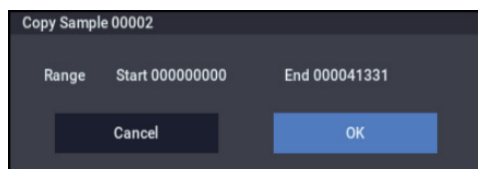

3. The range to be copied is shown by **Range Start** and **End**.
4. To execute the **Copy** command, press the **OK** button. To cancel, press the **Cancel** button.

Insert

When you execute this command, the sample data placed in the buffer by executing **Copy** in the SAMPLING mode Sample Edit page will be inserted at the **Start** address. The data that follows this address will be moved toward the end of the sample.

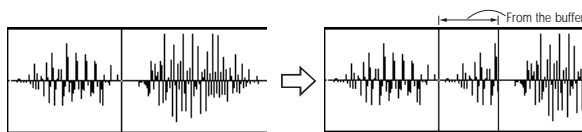

1. Use **Sample Select (1–1b)** to select the sample that you wish to edit, and set **Start** to specify the starting address. The **End** setting is ignored.
2. Select **Insert** to open the dialog box.

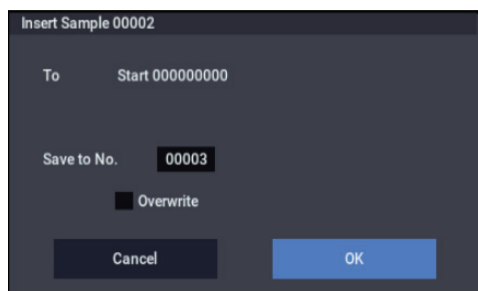

3. **To Start** will indicate the starting address at which the data will be inserted.

4. In **Save to No.**, specify the save destination sample number. By default, an unused sample number will be selected.

If **Overwrite** is checked, the sample number will be fixed to the current sample, and cannot be changed. See “About Overwrite” on page 605.

STEREO For stereo samples, use “Save to No.(L)” and “(R)” to specify the save-destination of the L and R channels.

5. To execute the **Insert** command, press the **OK** button. To cancel, press the **Cancel** button.

- If the buffer into which data was placed by the **Copy** command contains no data, the display will show the message, “Source sample is empty.”

Mix

When you execute this command, the sample data placed in the buffer by executing **Copy** in the SAMPLING mode Sample Edit page will be mixed with the selected sample data, starting at the **Start** address.

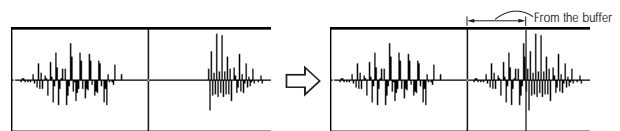

1. Use **Sample Select (1–1b)** to select the sample that you wish to edit, and set **Start** to specify the starting address. The **End** setting is ignored.
2. Select **Mix** to open the dialog box.

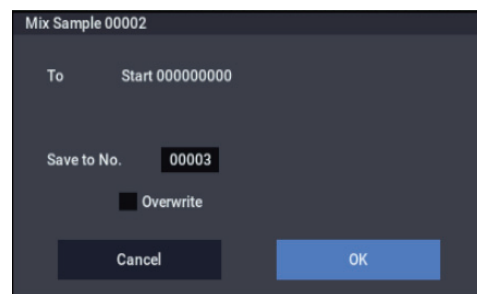

3. **To Start** will indicate the starting address at which the data will be mixed.

4. In **Save to No.**, specify the save destination sample number. By default, an unused sample number will be selected.

If **Overwrite** is checked, the sample number will be fixed to the current sample, and cannot be changed. See “About Overwrite” on page 605.

STEREO For stereo samples, use “Save to No.(L)” and “(R)” to specify the save-destination of the L and R channels.

5. To execute the **Mix** command, press the **OK** button. To cancel, press the **Cancel** button.

- If the buffer into which data was placed by the **Copy** command contains no data, the display will indicate “Source sample is empty.”

Paste

When you execute this command, the sample data placed in the buffer by executing **Copy** in the SAMPLING mode Sample Edit page will be placed in the sample starting at the **Start** address. The original data will be deleted, and overwritten by the sample data from the buffer.

You can also place sample data into a blank sample. This is convenient when you wish to **Copy** part of a sample and create a new sample based on it.

Pasting to a sample that contains sample data

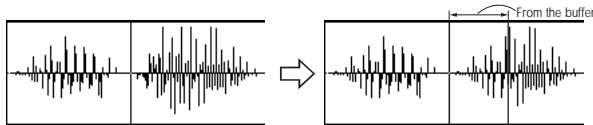

1. Use **Sample Select (1–1b)** to select the sample that you wish to edit, and set **Start** to specify the starting address. The **End** setting is ignored.
2. Select “**Paste**” to open the dialog box.

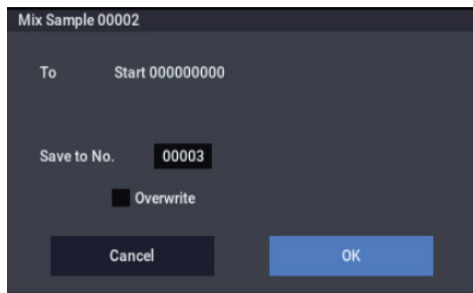

3. **To Start** will indicate the starting address at which the data will be pasted.
4. In **Save to No.**, specify the save destination sample number. By default, an unused sample number will be selected.

If **Overwrite** is checked, the sample number will be fixed to the current sample, and cannot be changed. See “About Overwrite” on page 605.

STEREO For stereo samples, use “Save to No.(L)” and “(R)” to specify the save-destination of the L and R channels.

5. To execute the **Paste** command, press the **OK** button. To cancel, press the **Cancel** button.

If the buffer into which data was placed by the **Copy** command contains no data, the display will indicate “Source sample is empty.”

Pasting to a sample that contains no sample data

1. Select the vacant sample number that you wish to paste.

If you select **---:---No Assign---** for **Sample Select** and then open the dialog box for this command, a vacant sample number will be selected automatically.

The **Start** and **End** settings will be ignored, and will have no effect. The beginning of the sample will be placed at address 0.

2. Select “**Paste**” to open the dialog box.

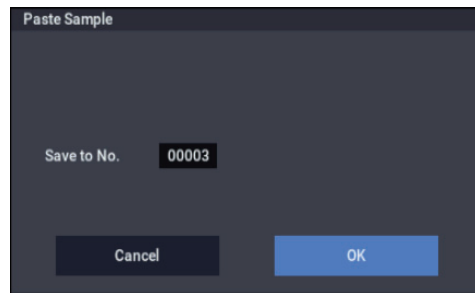

3. In **Save to No.**, specify the save destination sample number. If you wish to change it, re-specify the desired number.

STEREO For stereo samples, use “Save to No.(L)” and “(R)” to specify the save-destination of the L and R channels.

4. To execute the “**Paste**” command, press the **OK** button. To cancel without executing, press the **Cancel** button.

Insert Zero

This command inserts zero-level sample data (silence), beginning at the **Start** address. The data that previously occupied that location will be moved toward the end of the sample.

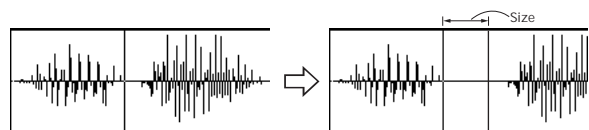

1. Use **Sample Select (1–1b)** to select the sample that you wish to edit, and set **Start** to specify the starting address. The **End** setting is ignored.
2. Select “**Insert Zero**” to open the dialog box.

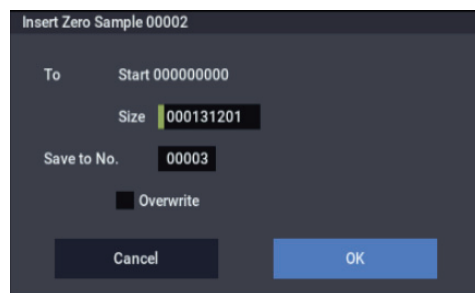

3. **To Start** will indicate the starting address at which the data will be inserted.
4. In “**Size**,” specify the length of the data that will be inserted.
5. In **Save to No.**, specify the save destination sample number. By default, an unused sample number will be selected.

If **Overwrite** is checked, the sample number will be fixed to the current sample, and cannot be changed. See “About Overwrite” on page 605.

STEREO For stereo samples, use “Save to No.(L)” and “(R)” to specify the save-destination of the L and R channels.

6. To execute the **Insert Zero** command, press the **OK** button. To cancel, press the **Cancel** button.

Normalize/Level Adjust

This command uniformly modifies the data values (volume) of the data between the **Start–End**. **Normalize** will amplify the level of the sample data as far as possible without allowing it to clip (distort). If the level of the sampled data is too low, you can execute this command to increase the dynamic range. **Level** allows you to raise or lower the level as desired.

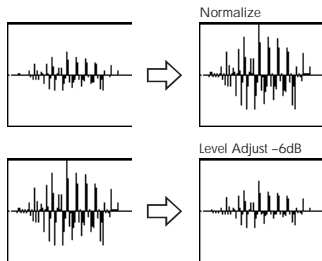

1. Use **Sample Select (1–1b)** to select the sample that you wish to edit, and use **Start** and **End** to specify the editing range.

You can press the SAMPLING START/STOP button or Play button to hear the portion that will be normalized or level-adjusted.

2. Select **Normalize/Level Adj.** to open the dialog box.

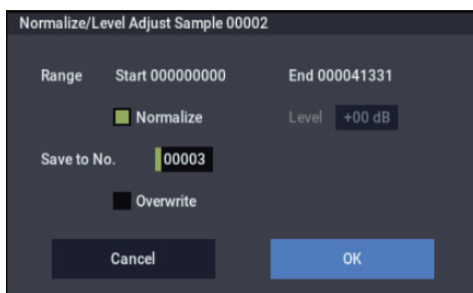

3. The range to be edited is shown by **Range Start** and **End**.
4. If you check **Normalize** and execute, the data will be normalized. In this case, the **Level** setting will be ignored.

If you wish to specify **Level** to modify the level of the sample data, do not check **Normalize**.

Each increase of +6 dB will approximately double the height of the waveform shown in the LCD. +12 dB will be an increase of approximately 4X, and +18 dB will be approximately 8X. Conversely, each decrease of –6 dB will halve the level, so that –6 dB will be 1/2X and –12 dB will be approximately 1/4X. Executing the **Level** command with positive (+) settings may cause the sound to clip (i.e., distort at the point that amplification beyond the maximum level is impossible). Once the sample data has been boosted beyond the clipping point, re-executing this command with negative (–) settings of **Level** will simply lower the overall level of the clipped signal –the waveform will remain distorted.

Also, if executing **Level** with negative (–) settings causes any portion of the sample data to reach a zero level, the zero data will not return to its original state even if you re-execute **Level** with positive (+) settings.

5. In **Save to No.**, specify the save destination sample number. By default, an unused sample number will be selected.

If **Overwrite** is checked, the sample number will be fixed to the current sample, and cannot be changed. See “About Overwrite” on page 605.

STEREO For stereo samples, use “Save to No.(L)” and “(R)” to specify the save-destination of the L and R channels.

6. To execute the **Normalize/Level Adjust** command, press the **OK** button. To cancel, press the **Cancel** button.

Be aware that if sample data of an extremely low level is normalized, any noise included in the sample will also be amplified.

Volume Ramp

This command modifies the data values (volume) between the **Start** and **End**. You can make the volume gradually increase (Fade In) or decrease (Fade Out) from the **Start** to the **End**.

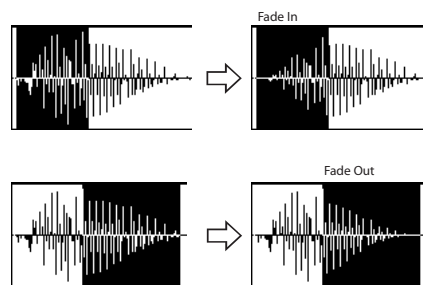

1. Use **Sample Select (1–1b)** to select the sample that you wish to edit, and use **Start** and **End** to specify the editing range.

You can press the SAMPLING START/STOP button or Play button to hear the portion on which “Volume Ramp” will be executed.

2. Select “**Volume Ramp**” to open the dialog box.

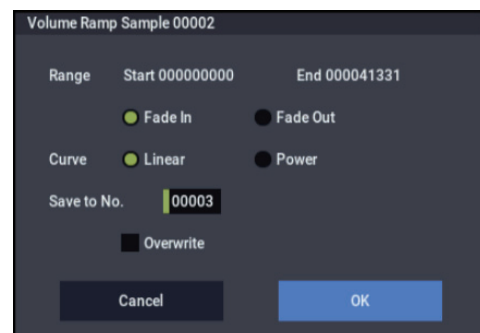

3. The range to be edited is shown by **Range Start** and **End**.

4. Use the radio buttons to select the type of volume ramp.

Fade In: The volume at Range **Start** will be zero, and will gradually increase toward **End**.

Fade Out: The volume will gradually decrease from the Range **Start** volume until it reaches zero at **End**.

5. In **Curve**, specify the way in which the volume will change.

Linear: The volume will change linearly. For normal fade-in or fade-out, select **Linear**.

Power: The volume will change non-linearly. When you use the **Mix** menu command to combine a faded-in waveform with a different faded-out waveform (i.e., crossfade), using a Linear fade-in/out may produce an impression that the volume has dropped in the middle of the curve. In such cases, use **Power** to perform the fade-in/out.

6. In **Save to No.**, specify the save destination sample number. By default, an unused sample number will be selected.

If **Overwrite** is checked, the sample number will be fixed to the current sample, and cannot be changed. See “About Overwrite” on page 605.

STEREO For stereo samples, use “Save to No.(L)” and “(R)” to specify the save-destination of the L and R channels.

7. To execute the **Volume Ramp** command, press the **OK** button. To cancel, press the **Cancel** button.

Rate Convert

This command lowers the sampling rate (frequency) of the sampled data by 2/3, 1/2, 1/3, 1/4, or 1/6. You can use this command to create “down-sampling” effects. The sample data is thinned to convert it to the lower sampling frequency.

The **Rate Convert** command is always executed on all waveform data of the selected sample, regardless of the **Start** and **End** settings.

1. Use **Sample Select (1–1b)** to select the sample that you wish to edit.
2. Select **Rate Convert** to open the dialog box.

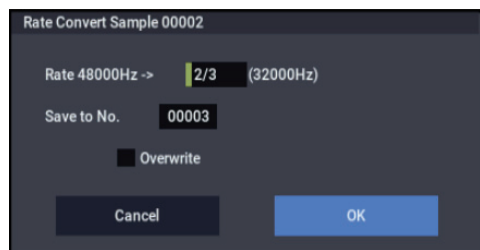



3. The sampling rate of the selected sample is shown at the right of “Rate.” At the right of the “→” you can select the desired amount of the sampling rate conversion: 2/3, 1/2, 1/3, 1/4 1/6. The sampling rate following conversion will be displayed in Hz.
4. In **Save to No.**, specify the save destination sample number. By default, an unused sample number will be selected.

If **Overwrite** is checked, the sample number will be fixed to the current sample, and cannot be changed. See “About Overwrite” on page 605.

STEREO For stereo samples, use “Save to No.(L)” and “(R)” to specify the save-destination of the L and R channels.

5. To execute the **Insert Zero** command, press the **OK** button. To cancel, press the **Cancel** button.

 This command cannot be executed on a sample whose sampling rate is 192Hz or less.

 The left and right channels of a Stereo sample must have the same sampling rate. Although it is possible to select mono multisamples for -L and -R and convert their sampling rate separately, the system will then no longer be able to handle the pair as a stereo sample.

Reverse

This command reverses the sample data (i.e., exchanges the beginning and end).

The **Reverse** command is always executed on all waveform data of the selected sample, regardless of the **Start** and **End** settings.

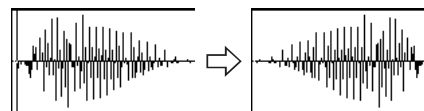

1. Use **Sample Select (1–1b)** to select the sample that you wish to edit.
2. Select **Reverse** to open the dialog box.

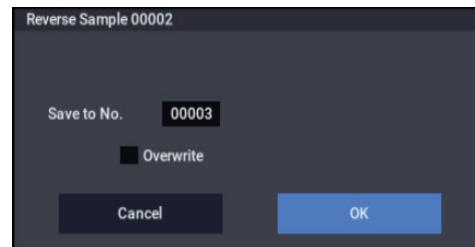

3. In **Save to No.**, specify the save destination sample number. By default, an unused sample number will be selected.

If **Overwrite** is checked, the sample number will be fixed to the current sample, and cannot be changed. See “About Overwrite” on page 605.

STEREO For stereo samples, use “Save to No.(L)” and “(R)” to specify the save-destination of the L and R channels.

4. To execute the **Reverse** command, press the **OK** button. To cancel, press the **Cancel** button.

Note: When you execute this command, all of the sample data will be rewritten to reverse its direction. The **Loop Edit** also contains a **Reverse (2–1d)** command, which simply reverses the playback direction without affecting the sample data itself.

Link

This command connects the currently selected sample with another sample.

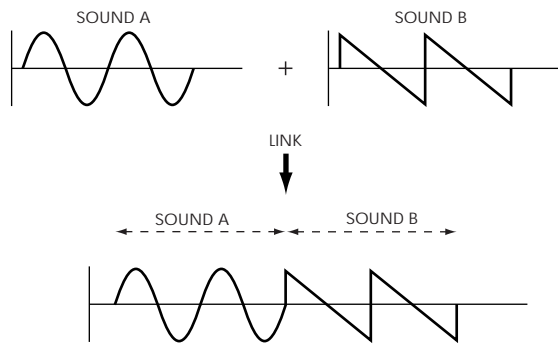

The volume of the two samples can be changed gradually at the transition to gradually mix the samples with each other. This is called crossfade, and can be used to produce a natural-sounding transition between the two sounds.

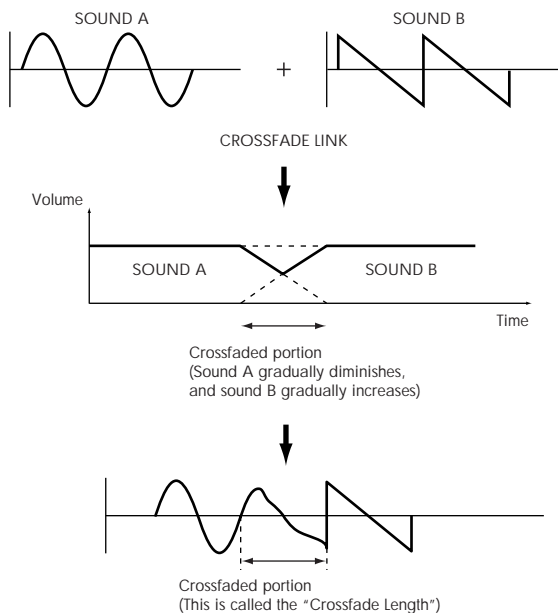

Link will be executed for all of the selected sample data, regardless of the **Start** and **End** settings.

1. Use **Sample Select (1-1b)** to select the sample that will be placed in front by the **Link** command.
2. Select **Link** to open the dialog box.

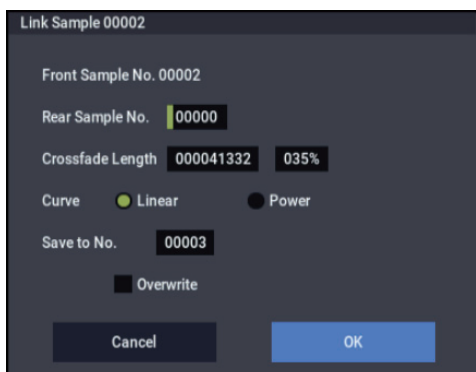

3. The sample number selected for **Front Sample No.** will be displayed. When the command is executed, this sample will be placed in front.

STEREO If you select one side of a stereo sample, it will automatically be detected as a stereo sample, and the other side of the sample will also be processed by the **Link** command.

If the **Front Sample** is mono and the **Rear Sample** is stereo, the L and R of the **Rear Sample** will be mixed to mono before linking.

If the **Front Sample** is stereo and the **Rear Sample** is mono, the identical sample will be placed in L and R of the **Rear Sample** before linking.

4. Use **Rear Sample No.** to select the sample number that will be linked.

When the command is executed, this sample will be placed in back.

5. In **Crossfade Length**, specify the length over which the crossfade will occur.

If you specify a % value, the proportion in relation to the entire **Front Sample** will be calculated automatically. If you specify 50%, the last half of the **Front Sample** will crossfaded.



If the rear sample is short, the **Crossfade Length** cannot be set any longer than the length of the **Rear sample**. In this case, it will not be possible to specify a value up to 100%.



After selecting a sample in step 1, you can set **Start** and specify the beginning of the crossfade while viewing the waveform. Set **End** to the end of the sample. If you specify these, **Crossfade Length** will indicate the length determined by **Start** and **End**.

6. In “Curve,” specify how you want the volume to change in the crossfaded portion.

Linear: The volume will change linearly.

Power: The volume will change non-linearly. In some cases, **Linear** may sound as though the volume diminishes in the middle of the curve. If this occurs, use **Power**.

7. In **Save to No.**, specify the save destination sample number.

An unused sample number will be selected by default.

If **Overwrite** is checked, the sample number will be fixed to the current sample, and cannot be changed. See “About Overwrite” on page 605.

STEREO For stereo samples, use “Save to No.(L)” and “(R)” to specify the save-destination of the L and R channels.

- To execute the Link command, press the OK button. To cancel without executing, press the Cancel button.

- If you link samples of different sampling rates (such as created by Rate Convert), the newly created sample will have the sampling rate of the Front sample.
- One vacant sample is used in order to execute Link. Be aware that if there are no vacant samples, an error will occur.

Truncate (for Loop Edit)

This command deletes unwanted data that lies outside of the Start, Loop Start, and End points (2-1d). After setting the start address, loop start address, and end address of the sample, use this command to delete unwanted sample data.

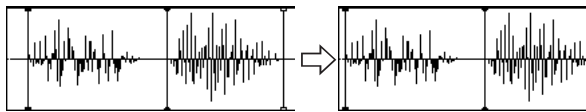

- Use Sample Select (2-1b) to select the sample that you want to edit, and use the Start or Loop Start points and the End point to specify the region that you want to edit.
- Select Truncate to open the dialog box.

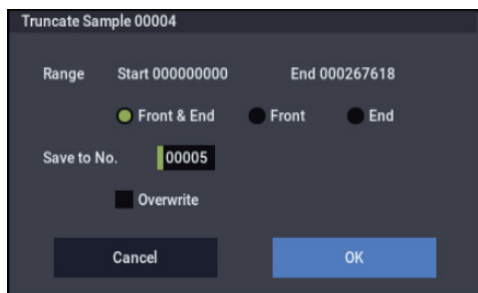

- Range Start and End will show the range of data that will be edited.
- Use the radio buttons to select the portion that will be deleted.
 - Front & End:** The sample data that lies before the Range Start (start address or loop start address) and after the Range End (end address) will be deleted.
 - Front:** The sample data that lies before the Range Start (start address or loop start address) will be deleted.
 - End:** The sample data that lies after the Range End (end address) will be deleted.
- In Save to No., specify the save destination sample number. By default, an unused sample number will be selected.

If Overwrite is checked, the sample number will be fixed to the current sample, and cannot be changed. See “About Overwrite” on page 605.

STEREO For stereo samples, use “Save to No.(L)” and “(R)” to specify the save-destination of the L and R channels.

- To execute the Truncate command, press the OK button. To cancel, press the Cancel button.

Time Slice

Time Slice lets you convert a mono or stereo rhythmic sample, such as a drum loop, into a set of individual hits and matching sequencer data. You can then:

- Re-create the loop by playing the sequencer data
- Change the tempo of the loop, without altering the pitch
- Change the pitch of the samples, without altering the tempo
- Change the rhythmic feel by altering quantization, swing, etc.
- Change the pattern of the loop by swapping or deleting individual hits, or otherwise editing the sequencer or sample data

In detail, **Time Slice** does the following:

- Detects the individual beats in the original loop
- Splits each beat into a separate sample
- Creates a Multisample with the original loop on the note C2, and the individual beats on separate keys starting on D2
- Creates a Program which uses the new Multisample
- Creates Sequencer data to re-create the sound of the original loop by playing the individual hits

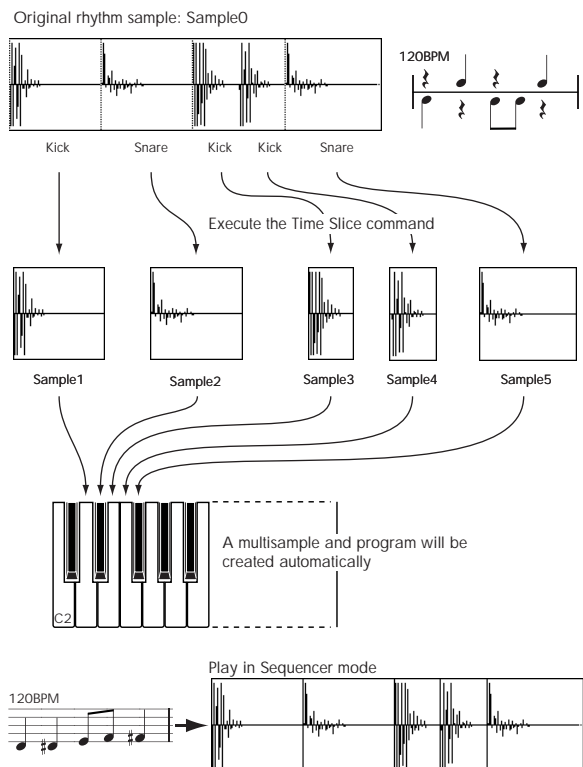

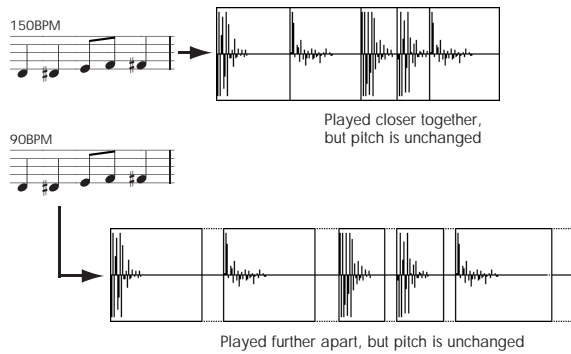

* You can also use the Time Stretch command to control the compression of each sample to optimize the "spacing" to match the tempo. step 9

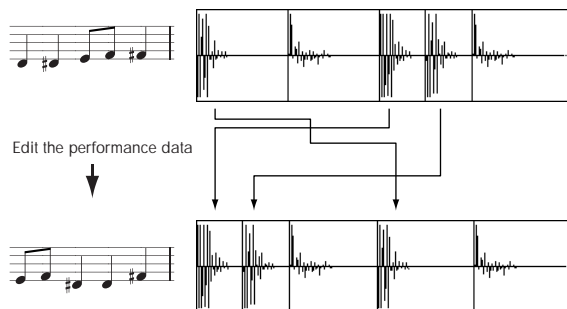

Note: As an alternative to the **Time Slice** command, the **Time Stretch** menu command is another way to change the tempo of a rhythm loop or similar sample. You may wish to use this if you don't need to divide the sample and create song performance data for the divided samples.

1. Select the sample in the Sample Select (2-1b) for which you wish to execute Time Slice.



2. Select the Time Slice to open the dialog box.

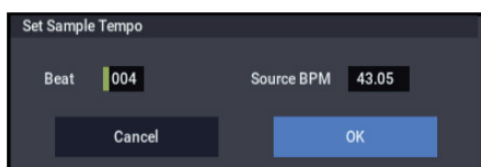

3. Specify the number of quarter-note beats and tempo of the currently selected sample. If you know the BPM of the original waveform, set Source BPM. If you do not know the BPM, specify Beat and the BPM will be calculated automatically.

The setting you make here will be used as the reference value when detecting the attack, when performing Time Stretch in step 9b, and when saving the sequence data in step 10.

Beat: Specifies the number of quarter-note beats. When you specify **Beat**, the **Source BPM** will indicate the playback BPM at the original key. This BPM value will automatically be calculated from the start address to the end address (if loop is off) or from the loop start address to the end address (if loop is on) of the selected sample. If you know the BPM and it is different than the displayed value, change **Source BPM** to the correct value.

For example in the case of a 120 BPM sample of one measure of 4/4 time, set **Beat** to 4. The **Source BPM** will be calculated automatically. If the **Source BPM** is not set to 120.00, due to inaccuracies in the start address (or loop start address) and end address, change the **Source BPM** to 120.00.

Source BPM: Specifies the tempo at the original key of the source waveform.

4. To execute Time Slice, press the OK button. To cancel without executing, press the Cancel button.

When you press the OK button, the attacks will be detected, the sample will automatically be sliced, and a dialog box will appear.

STEREO In the case of a stereo sample in which L and R have different lengths, silent data will automatically be added to the end of the shorter sample so that the two samples will be the same length.

- ⚠ If you want to re-set **Beat** and **Source BPM** after pressing the OK button, you can do so in step 9a).



5. Listen to the samples that were divided by detecting their attacks.

The sample before slicing is assigned to the C2 note of the keyboard, and the sliced samples are assigned to notes D2 and above. When you change the **Index**, the corresponding display will be highlighted, allowing you to view the sliced waveforms.

You can also select an index by holding down the ENTER button and pressing a note on the keyboard. The index that is assigned to the note you pressed will be selected.

To hear the sliced sounds, you can either press the corresponding note on the keyboard, or change the index to select the desired sample and then press the SAMPLING START/STOP button. When you press the SAMPLING START/STOP button, the sound between the specified **Start** and **End** will be played at the original key.

Keyboard: This shows the multisample that is being used temporarily in this dialog box.

When you play the keyboard, this multisample will sound. It will behave in the same way as in normal pages (such as the Recording page). (0-1a)

STEREO In the case of a stereo sample, a stereo multisample will be temporarily used. The sample at each index will sound in stereo.

Time Slice step 4



Index [Source, xxx(001...090)/yyy(001...090)]

Selects the sample index.

If this is set to Source, the original waveform before time slicing will be selected.

By selecting xxx/yyy you can specify individual samples that were sliced. xxx indicates the selected sample, and yyy indicates the total number of samples that were sliced. A maximum of 90 samples can be assigned to the keyboard. If more than 90 samples were sliced, this will display 90.

Sample waveform display: Gray lines indicate the locations at which the sample is sliced. Red and blue lines indicate the Start and End addresses respectively. When **Index** is xxx/yyy, the sample of the selected index will be highlighted.

STEREO In the case of a stereo sample, the L channel sample data will be displayed above, and the R channel sample data will be displayed below.

ZOOM: You can zoom in and zoom out in the vertical and horizontal dimensions of the waveform shown in the sample waveform display. (1–1f)

- 6. **If the slice locations are not appropriate, you can adjust Sensitivity to change the sensitivity at which the attacks are detected, in order to change the slice locations.**

Sensitivity [00...30]

Adjusts the sensitivity at which the attacks are detected. By increasing this value, you can detect attacks at even lower levels, to create more finite slices.

The Level in this case does not necessarily correspond to the “waveform level.”

Depending on the sample, the desired slicing may not occur even if you increase the **Sensitivity**. If the attack portion of the following sample has overlapped into the end of the sample, or if the sample contains two sounds, make adjustments in step 7.

- 7. **Make adjustments where the automatic attack detection did not occur correctly.**

Change **Index** to select the sample that you wish to adjust. Make adjustments by changing **Start** and **End**, and by executing **Divide** or **Link** to adjust the slice location.

Start: Specify the start address for the sample of the currently selected **Index**. At the same time, the end address of the sample for the preceding **Index** will also be adjusted.

End: Specify the end address for the sample of the currently selected **Index**. At the same time, the start address of the sample for the next **Index** will also be adjusted.

When adjusting the **Start** and **End** addresses of the divided samples, use **ZOOM** to increase the magnification (×1 or more) so that the sample waveform is displayed accurately when you make adjustments. (1–1f)

If **Index** is set to Source, the address of the original waveform will be modified. If you change the start address, the loop start address will also be changed at the same time.

Use Zero: (1–1d)

If you wish to adjust the **Start** or **End** of a divided sample, it is best to first check **Use Zero**. In general, using zero-cross points to specify sample addresses will make it less likely that clicks or pops will occur, particularly at the **End**.

Divide: This splits the sample of the currently selected **Index** into two. Use this when you wish to add another location to slice the sample. Modify **End** or **Start** to adjust the divided sample.

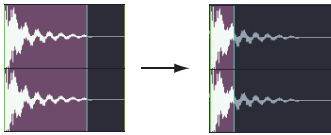

Link: This joins the sample of the currently selected **Index** to the sample of the next **Index**. Use this when you wish to merge together two sliced locations.

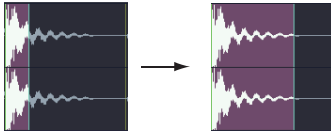

When you use Time Slice on a rhythm loop sample, the quality of the playback in SEQUENCER mode will depend largely on the “cutoff” of each percussion instrument sound that was sliced.

Be aware that if you change the **Sensitivity** after adjusting the slice location, the attacks will be re-detected and the sample will automatically be sliced again.

What kind of slices will produce the best result?

- A. Divide the separate percussion instrument notes as finely as possible
- For example in the case of a sample where the decay of the kick is overlapped by the hi-hat, the attack sound of the kick and the attack sound of the hi-hat should be sliced to create two samples. If these sounds are left as one sample (containing both kick and hi-hat), their rhythm may become incorrect when the sample is played at a different tempo.

Kick + Hi-hat kick/Hi-hat

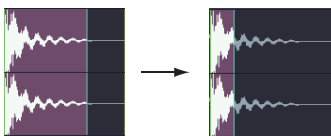

- If the sample is not sliced appropriately even after you adjust the **Sensitivity** use **Divide** to divide the sample into halves, and adjust **End** and **Start** as needed.
- B. Make sure that each divided sample has a clear attack
- The attack portion is vital for percussion sounds. Slice the sample at a point where the attack will be sounded crisply.
- C. Avoid the noise that can occur toward the end of each divided sample

For example as shown in the above right illustration, noise can be present at the end of the kick sample. Adjust the end address of the kick sample so that the noise is not obtrusive.

In this case, adjusting the end address will also affect the start address of the hi-hat sample. While listening to the two samples, make adjustments so that the noise at the end of the kick sample is as inconspicuous as possible, and also that the hi-hat attack is heard cleanly.

Pay attention to these points as you adjust **Sensitivity**. If necessary, use the methods described above to edit each sample.

The noise occurring at the end of the sample in “C.” will be automatically reduced when you execute steps 8 and following. You should adjust **Sensitivity** while paying

particular attention to sections “A” and “B,” and then execute step 9. If the noise is still obtrusive, then you can adjust the end address.

8. Save the sliced samples to the multisample to which they have been assigned.

When you press the Save button, the “Save Samples & MS” dialog box will appear.

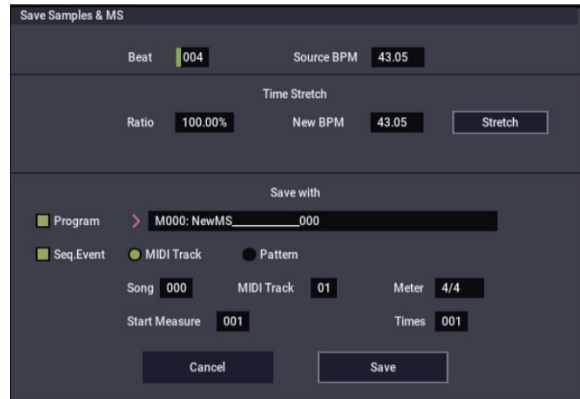

9. Use Time Stretch to adjust the length of the sliced samples.

When you press the Stretch button, Time Stretch (a function that expands or shrinks the length of a sample without affecting its pitch) will be applied to the sliced sample.

If you wish to save the sliced sample as it is, proceed to step 10 without executing Time Stretch.

Sometimes when a sliced sample is played in SEQUENCER mode and the tempo is slowed down, the silent portion between samples may become obvious or noise may be more apparent, producing an unnatural-sounding result. To avoid this, you can use Time Stretch to adjust the length of the individual samples. The length of the samples will automatically be optimized according to the **Ratio** and **New BPM** settings.

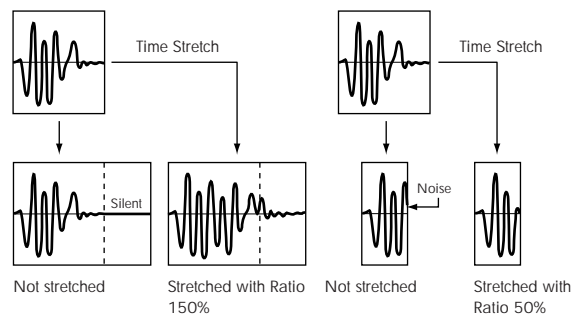

If you execute Time Stretch at 100%, the sample length will not change but the end of the sample will be faded out, reducing the noise.

- a) Set **Beat** and **Source BPM**. The method is the same as in step 3. If you wish to change the value you set in step 3, you can change it here.
- b) Specify the length of the sample that will be created by Time Stretch.
 - To specify the length as a ratio
 - Set **Ratio**. The available range is 50.00–200.00%. If you specify 50.00%, the sample length will be halved. (The tempo will double.) If you specify 200.00%, the sample length will double. (The tempo will be halved.)
 - To match an existing BPM tempo value

Use **New BPM** to specify the BPM value of the sample you wish to create. The **Ratio** will automatically be calculated from the **Source BPM** and the **New BPM** values.

It is not possible to make settings that would cause **Source BPM** or **New BPM** to exceed the range of 40.00–480.00.

It is not possible to make settings that would cause **Ratio** to exceed the range of 50.00–200.00.

Press the Stretch button to execute Time Stretch. When you execute the command, the time-stretched samples will automatically be assigned to notes D2 and above of the keyboard, allowing you to audition the sound. You can change **Ratio** and **New BPM** as many times as desired and continue auditioning the result.

When you audition the time-stretched samples, the sound you hear is the sound of each divided sample as it will be played in SEQUENCER mode. If there is obtrusive noise or if the attack is not sound cleanly, return to step 7 and adjust the **Start** and **End** addresses, etc.

10. Set “Save with” to specify the data that will be created simultaneously when you press the Save button to save the samples

Program: If this check box is checked, the multisample will be converted to a program when you save it. Specify the destination program number.

Seq.Event: If this check box is checked, sequence data to play the sliced samples will automatically be created after the data is saved.

You can specify whether the sequence data to play back the sliced samples will be created as track data or as pattern data. If pattern data is created, you can also assign the pattern to RPPR.

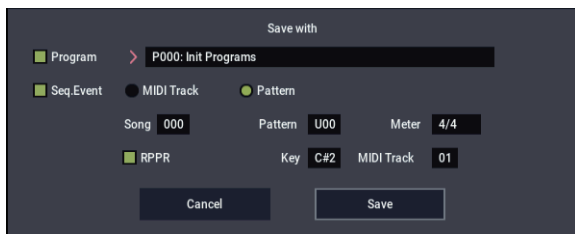

If you choose the Track radio button, track data will be created. Use **Song**, **Track**, and **Meter** to specify the song number, track number, and time signature of the data that will be created.

The track data that is created will start at the measure specified by **Start Measure**, and will repeat for the number of times specified by **Time**.

When track data is created, any data that had existed within the specified range of measures will be erased. Data outside this range will not be erased.

If you check both **Program** and **Seq.Event** and select the Track, the song parameter **Program Select** (SEQUENCER 0–1b) will automatically be specified if the **Start Measure** is 001. Also, a program change will be created at the **Start Measure** location. In SEQUENCER mode you can select the song and play it back to hear the result immediately. Normally you will check both of these boxes.

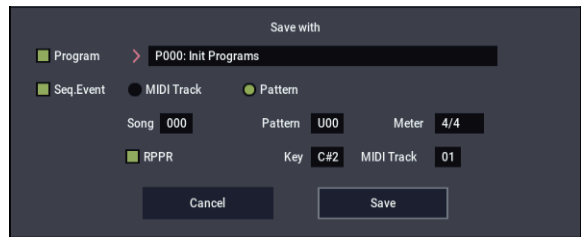

If you choose the Pattern radio button, pattern data will be created.

Use **Song**, **Pattern**, and **Meter** to specify the song number, pattern number, and time signature of the data that will be created.

RPPR: If you check the check box, pattern data to play the sliced samples will be assigned to RPPR when you save. Use **Key** and **Track** to specify the key and track that will be created.

If **Program**, **Seq.Event**, and **RPPR** are all checked, the song parameters **Program Select** (SEQUENCER 0–1c/2c) and **RPPR ON/OFF** (SEQUENCER 0–1a) will both be specified automatically. **RPPR ON/OFF** will be turned on.

In SEQUENCER mode you can select the song and pattern to play back the results immediately. If **RPPR** is checked, pressing the specified key will play the pattern. Normally you will check both of these boxes.

Note: In some cases, the sample End address setting etc. may increase the number of measures in the pattern, so that it no longer loops precisely. In such cases, re-specify the **Length** in the SEQUENCER mode **Pattern Parameter** menu command.

Note: If you use **Seq.Event** and **Start Measure 001**, the **Tempo** (0–1c) of the track data or pattern data that is created will be the value specified by **New BPM** if you executed Time Stretch. If you did not execute Time Stretch, the tempo will be the value specified for **Source BPM**.

If you set **Start Measure** to 001 and create a track, and if a tempo event exists only at the beginning of the master track, the tempo of that event will also be the value that you specified as **New BPM** or **Source BPM**.

If you save to a song that already contains data, the time-sliced samples may not play back in the same way as original sample if the time signature is different. You must set a matching time signature in the master track.

11. If you wish to save, press the Save button. If you decide not to save, press the Cancel button. When you save, the samples and multisample will automatically be saved to vacant samples and multisamples.

STEREO In the case of stereo samples, the samples and multisample will be saved in stereo.

12. By repeating steps 6–11 you can create as many samples and multisamples as desired.

13. Press the Exit button to exit the Time Slice command.

If you exit Time Slice without using the Save button to save the samples and multisamples, be aware that the samples and multisamples you create will be lost.

Before executing **Time Slice** on a long sample, you should first divide the sample into measures. In some cases, it may not be possible to assign the sample to the keyboard or create sequence data.

Time Slices requires vacant samples, multisamples, and relative parameters in order to execute. Be sure that there is sufficient free area before you execute. If there is insufficient free area, an error will occur.

Note: If you open the **Time Slice** dialog box on the same sample, it will be sliced in the same way as previously. These slice locations will also be used if you execute **Slice** in the **Time Stretch** menu command, so that you don't have to make the settings again.

If you wish to detect the attacks again or to re-do the operation, change the **Sensitivity** after you open the dialog box.

Time Stretch

Time Stretch lengthens or shortens a sample without changing its pitch. This is convenient when you wish to change the tempo of a rhythm loop (drums) or a melodic sample (e.g., vocal, strings, winds) to match the tempo of another sample or of the sequencer. The NAUTILUS provides two ways in which Time Stretch can be executed.

This command also supports stereo samples.

Sustaining

This type is suitable for sustained sounds such as vocal or instruments. Using it to change the tempo of phrases such as guitar or piano will also produce good results.

Slice

This type is suitable for decay-type instruments such as drums. Using it to change the tempo of drum or percussion loops will produce good results with minimal effect on the attack.

Note: It is possible to change the pitch when you adjust the tempo of a rhythm loop or similar sample, using the **Detune BPM Adjust** menu command. You can create interesting effects by raising or lowering the pitch of a drum sound. For more information, see “Detune BPM Adjust” on page 437.

Using Time Stretch (Sustaining)

1. Select the sample that you wish to time-stretch using the Sustaining method.



2. Select the **Time Stretch** command to access this dialog box, where you can select the desired time stretch method.

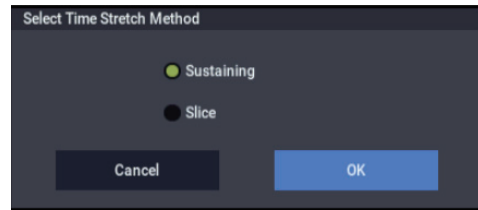

3. Use the radio buttons to select **Sustaining**. Then press the **OK** button to execute, or the **Cancel** button to cancel without executing.

STEREO If the L and R of a stereo sample are different in length, blank data will automatically be added to the end of the shorter sample so that it matches the longer side.

4. The **Time Stretch** dialog box will appear.

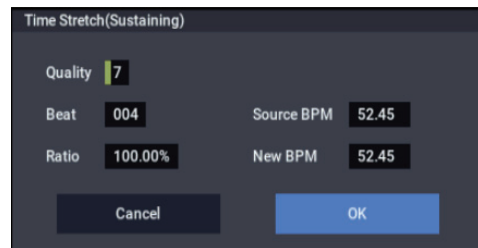

5. Set **Quality** to specify the desired audio quality of the sample produced by **Time Stretch**.

The range is 0–7. Higher settings will generally produce better results (depending on the sample being processed), but will also increase the processing time.

Since you can try this as many times as you like, you should normally start with about 4, and raise or lower the setting gradually.

6. Set the proportional length of the sample that will be created by **Time Stretch**.

- To specify the length as a ratio:

Set the **Ratio** to the desired value. The available range is 50.00%–200.00%.

50.00% reduces the sample to half of its original length, doubling the tempo.

200.00% increases the sample to double its original length, slowing the tempo to half-speed.

The tempo of the resulting sample will be calculated automatically based on the **Ratio** and **Source BPM**, and displayed in **New BPM**.

- To match an existing BPM tempo value:

Set **Beat** as the number of quarter-note beats. When you change **Beat**, the **Source BPM** value will be changed automatically.

Source BPM will indicate the playback BPM value at the original key. This BPM value is automatically calculated according to the length from the start address to the end address (if loop is off) or from the loop start address to the end address (if loop is on). If you already know the BPM value and the calculated value is incorrect, change it to the correct value.

Use **New BPM** to specify the BPM value of the sample you wish to create. **Ratio** will automatically be calculated from the **Source BPM** and **New BPM** values.

For example if you have a one-measure 120 BPM sample in 4/4 time, and would like to change it to 150 BPM, you

would set **Beat** to 4. The **Source BPM** will be calculated automatically. If the **Source BPM** is not calculated as 120.00 due to inaccuracies in the start address (or loop start address) or end address, adjust **Source BPM** to the correct value of 120.00.

Next, set **New BPM** to 150.00. The **Ratio** will be calculated automatically.

It is not possible to make settings that would cause **Source BPM** or **New BPM** to exceed the range of 40.00–480.00.

It is not possible to make settings that would cause **Ratio** to exceed the range of 50.00–200.00.

Depending on the sample, the length may not be exactly as you specify, due to limitations in processing accuracy.

7. To execute the Time Stretch operation, press the OK button. To cancel without executing, press the Cancel button.

When you press the OK button, the Time Stretch dialog box will appear.



8. Audition the sample that was created by Time Stretch.

The sample before being time-stretched is assigned to the C2 note of the keyboard, and the sample that was time-stretched is assigned to C#2. You can change the **Index** to check the waveform.

Keyboard: This shows the multisample that is used temporarily in this dialog box.

When you play the keyboard, this multisample will sound. It will behave just as in normal pages (e.g., the Recording page). (0–1a)

STEREO In the case of a stereo sample, a stereo multisample will be used temporarily. The sample at each index will sound in stereo.

Index **[Source, Result]**

Selects the index for the sample whose waveform you wish to display.

If you select Source, the original waveform before time-stretching will be selected.

If you select Result, the time-stretched sample will be selected.

You can also select the index by holding down the ENTER button and pressing a note on the keyboard. The index that includes that note will be selected.

Sample waveform display: This shows the waveform of the selected sample. As in 2–1: Loop Edit, the Start, Loop Start, and End addresses are shown by a solid line.

STEREO In the case of a stereo sample, the L channel sample data will be displayed above, and the R channel data below.

ZOOM: This controls horizontal and vertical zoom in/out for the waveform shown in the “Sample waveform display.” (1–1f)

Start:

End:

Specify the start address and end address of the sample for the currently selected index.

When you execute Time Stretch, the addresses will be specified automatically, but the playback may be slightly skewed due to inaccuracies in the end address, etc. If this occurs, you can correct the addresses manually.

When you change the start address, the loop start address will also be changed simultaneously. If you wish to independently adjust the start address and loop start address, save the data in step 10, and then make settings in the Loop Edit page.

To audition the sound in the specified range, play the keyboard or press the SAMPLING START/STOP button. When you press the SAMPLING START/STOP button, the sample in the range specified by **Start** and **End** will sound at the original key.

Use Zero: (1–1d)

9. If you press the Stretch button, the Time Stretch dialog box will appear, and you can re-do the time stretch once again. Execute Time Stretch as described in step 6.

10. Save the sample that you created. Press the Save button, and the Save dialog box will appear.

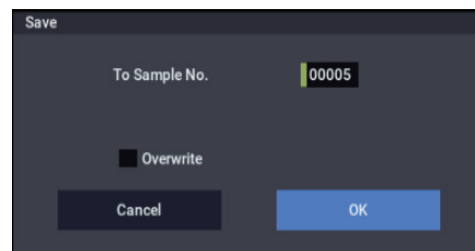

In “To Sample No.,” specify the save destination sample number. By default, an unused sample number will be selected. If **Overwrite** is checked, this cannot be selected.

If **Overwrite** is checked, the sample number will be fixed to the current sample, and cannot be changed. See “About Overwrite” on page 605.

STEREO For stereo samples, use “Save to No.(L)” and “(R)” to specify the save-destination of the L and R channels.

To execute the Save operation, press the OK button. To cancel without saving press the Cancel button.

11. By repeating steps 9–10 you can create more samples as desired.

12. Press the Exit button to exit the Time Stretch operation.

The index will specify the last-saved sample number.

Note: If you to use the saved sample in PROGRAM mode or SEQUENCER mode, you can use the **Convert MS To Program** menu command, or you can select that multisample for the “2–1c: OSC1 Multisample/Wave Sequence” or “2–5: OSC2 Basic” parameters “MS1”–“M4” (if “Type” = Multisample) and create a program.

Be aware that if you exit Time Stretch without using the Save button then press the OK button to save the sample, the sample(s) you created will be lost.

Time Stretch requires vacant samples, multisamples, and relative parameters in order to execute. Before you execute, make sure that there is sufficient free space. If there is not, an error will occur.

To use Time Stretch (Slice)

1. Select the sample that you wish to time-stretch using the Slice method.



2. Select the Time Stretch command from the Page Menu to access this dialog box, where you can select the desired time stretch method.

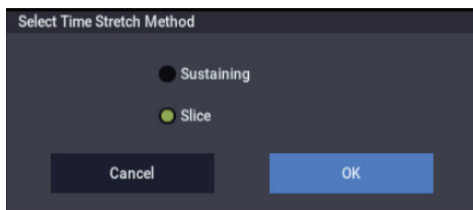

3. Use the radio buttons to select Slice. Then press the OK button to execute, or the Cancel button to cancel without executing.

STEREO If the L and R of a stereo sample are different in length, blank data will automatically be added to the end of the shorter sample so that it matches the longer side.

4. A dialog box for executing Time Stretch will appear.

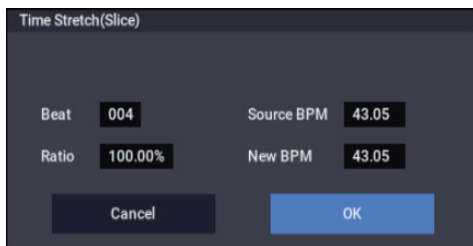

5. Specify the number of quarter note beats and tempo of the currently selected sample.

If you already know the BPM value, set **Source BPM**. If you do not know the BPM, setting **Beat** will cause the BPM to be calculated automatically. The settings here are also used as the reference values when detecting the attacks at which the sample is divided.

Beat: Specify the number of quarter note beats. When you change **Beat**, the **Source BPM** will indicate the BPM value for playback at the original key. This BPM value is automatically calculated according to the length from the start address to the end address (if loop is off) or from the

loop start address to the end address (if loop is on). If you already know the BPM value and the calculated value is incorrect, change **Source BPM** to the correct value.

For example if you have a one-measure 120 BPM sample in 4/4 time, you would set **Beat** to 4. The **Source BPM** will be calculated automatically. If the **Source BPM** is not calculated as 120.00 due to inaccuracies in the start address (or loop start address) or end address, adjust **Source BPM** to the correct value of 120.00.

Source BPM: Specify the tempo at the original key of the original waveform.

Source BPM cannot be set or displayed outside the range of 40.00–480.00.

6. Set the proportional length of the sample that will be created by Time Stretch.

- To specify the length as a ratio:

Set the **Ratio** to the desired value. The available range is 50.00%–200.00%.

50.00% reduces the sample to half of its original length, doubling the tempo.

200.00% increases the sample to double its original length, slowing the tempo to half-speed.

The tempo of the resulting sample will be calculated automatically based on the **Ratio** and **Source BPM**, and displayed in **New BPM**.

- To match a desired BPM tempo value:

Set **New BPM** to the desired BPM value of the sample that will be created. **Ratio** will automatically be calculated from the **Source BPM** and **New BPM** values.

It is not possible to set or display **New BPM** outside the range of 40.00–480.00. It is not possible to set or display **Ratio** outside the range of 50.00–200.00.

7. To execute Time Stretch, press the OK button. To cancel without executing, press the Cancel button. When you press the OK button, the attacks will be detected and the sample will be divided automatically, and time stretch will be performed.

The **Time Stretch** dialog box will appear.



8. Audition the results that were created by Time Stretch.

The sample before being time-stretched is assigned to the C2 note of the keyboard. The time-stretched sample is assigned to C#2. Sliced (divided) samples will be assigned consecutively upward, starting from D2 on the keyboard.

Index [Source, Result, xxx(001...090)/yyy(001...090)]

Selects the index for the sample whose waveform you wish to display.

If you select Source, the original waveform before time-stretching will be selected.

If you select Result, the time-stretched sample will be selected.

If you set this to xxx/yyy, an individually sliced sample will be selected. xxx is the selected index, and yyy indicates the total number of sliced samples. A maximum of 90 samples can be assigned to the keyboard. If the sample was sliced into more than 90 samples, this will be displayed as 90.

You can also select an index by holding down the ENTER button and playing a note on the keyboard. The index that includes that note will be selected.

When you execute Time Stretch, the addresses will be specified automatically. However, playback may be slightly offset due to inaccuracies in the end address, etc. If this occurs, set **Index** to Result, and use **Start** and **End** to re-specify the addresses.

Keyboard: This shows the multisample that is temporarily used in this dialog box.

When you play the keyboard, this multisample will sound. It will act in the same way as in normal pages (e.g., the Recording pages). (0–1a)

STEREO In the case of a stereo sample, a stereo multisample will be used temporarily. The sample of each index will sound in stereo.

Sample waveform display: This displays the waveform of the selected sample. If the **Index** is other than Result, the locations at which the sample is sliced will be indicated by a gray-colored line. If **Index** is set to xxx/yyy, the sample of the selected index will be highlighted. If **Index** is other than xxx/yyy, the Start, and End addresses will be indicated by red, green, and blue colored lines, respectively.

STEREO In the case of a stereo sample, the L channel sample data will be displayed above, and the R channel sample data will be displayed below.

ZOOM: This lets you zoom the waveform display, in or out, vertically and horizontally.

9. If the slice locations are not appropriate, use **Sensitivity** to modify the sensitivity at which the attacks are detected, thus changing the slice locations.

Sensitivity [00...30]

For information about the **Start**, **End**, **Use Zero**, **Divide**, and **Link** parameters, see “Time Slice” on page 620, steps 6 and 7.

10. When you press the Stretch button, the Time Stretch dialog box will appear, and you can re-do the time stretch.

Execute Time Stretch using the same procedure as in step 5. If the sample slice locations are not appropriate, this will also affect the result of Time Stretch. For details on setting the slice locations, see “Time Slice” on page 620, steps 6 and 7.

11. Save the sample you created. Press the Save button, and the Save dialog box will appear.

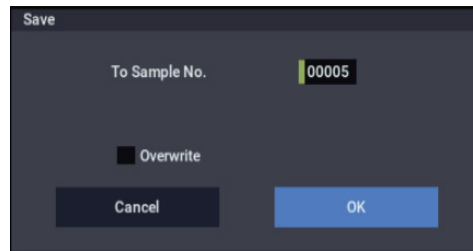

In “To Sample No.,” specify the save destination sample number. By default, an unused sample number will be selected. If **Overwrite** is checked, this cannot be set.

If you wish to delete the original sample data and overwrite it with the edited sample, check **Overwrite**.

If you execute this command with **Overwrite** checked, the original sample data will be deleted, and overwritten by the edited sample data. Thus, in the Time Stretch dialog box that appears after execution, the edited sample data will automatically have its attacks detected and sliced, and displayed in **Index Source**.

STEREO For stereo samples, use “Save to No.(L)” and “(R)” to specify the save-destination of the L and R channels.

To execute the Save, press the OK button. To cancel without executing, press the Cancel button.

12. By repeating steps 10–11 you can create more samples as desired.

13. Press the Exit button to end the Time Stretch operation.

The last-saved sample number will be set for the index.

Note: If you to use the saved sample in PROGRAM mode or SEQUENCER mode, you can use the **Convert MS To Program** menu command, or you can select that multisample for the “2–1c: OSC1 Multisample/ Wave Sequence” or “2–5: OSC2 Basic” parameters “MS1”–“M4” (if “Type” = Multisample) and create a program.

Be aware that if you exit **Time Stretch** without using the Save button, and then press the OK button to save the sample, the sample(s) you created will be lost.

Before executing the **Slice** on a long sample, you should first divide the sample into measures. In some cases, it may not be possible to assign the sample to the keyboard or edit the slice locations.

Time Stretch requires vacant samples, multisamples, and relative parameters in order to execute. Before you execute, make sure that there is sufficient free space. If there is not, an error will occur.

Note: If you open the time slice (Slice) dialog box on the same sample, it will be sliced in the same way it previously was. These slice locations will also be used if you use the **Time Slice** menu command, so that you don’t have to make the settings again.

If you wish to detect the attacks again or to re-do the operation, change the **Sensitivity** after you open the dialog box.

Crossfade Loop

When looping a pitched instrument sample of a complex sound such as strings or woodwinds to make the sound sustain, it is necessary to create a long loop to preserve the rich character of the sound. **Crossfade Loop** can be used to minimize the difference in sound between the two regions to create a natural-sounding loop.

In order to solve such problems, **Crossfade Loop** causes the sound to change gradually from the end to the beginning of the loop.

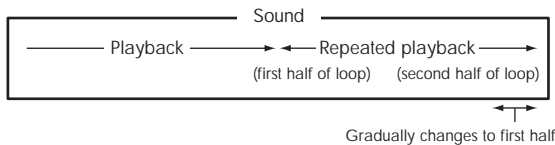

In actuality, the sample data is created as follows. A specific length (the **Crossfade Length**) of the waveform immediately before the beginning of the loop is taken and mixed with the end portion.

At this time, the waveform level of the portion immediately before the end (the length specified by **Crossfade Length**) will gradually decrease, and the waveform level immediately before the beginning of the loop will gradually increase as the two are mixed.

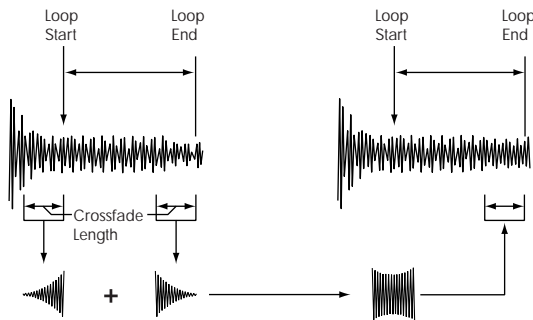

1. Select the sample that you wish to Crossfade Loop.
2. Select Crossfade Loop to open the dialog box.

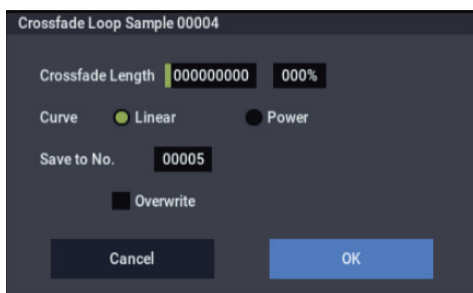

3. In **Crossfade Length**, specify the length of the sample that you wish to crossfade.

If you set this as %, **Crossfade Length** will be calculated automatically. Specify the proportion of the **Crossfade Length** relative to the length between the loop start and loop end. If you set this to 50%, crossfade will be performed on the second half of the region between loop start and loop end.

If the length from the beginning of the sample to the loop start is shorter than the length from the loop start to the loop end, **Crossfade Length** can be set only up to the length from the beginning of the sample to the loop start. In this case, a setting of 100% will not be possible.

4. Set “**Curve**” to specify how the volume will change in the crossfaded region.

Linear: The volume will change linearly.

Power: The volume will change non-linearly. Sometimes a setting of Linear will produce the impression that the volume has dropped in the middle of the curve. In such cases, use Power.

5. In **Save to No.**, specify the save destination sample number. By default, an unused sample number will be selected.

If **Overwrite** is checked, the sample number will be fixed to the current sample, and cannot be changed. See “About Overwrite” on page 605.

STEREO For stereo samples, use “Save to No.(L)” and “(R)” to specify the save-destination of the L and R channels.

6. To execute **Crossfade Loop**, press the **OK** button. To cancel without executing, press the **Cancel** button.

Pitch BPM Adjust

This command sets the **Pitch** (3–1b) of the selected index on the basis of a BPM value. Raising the pitch of sample playback will increase the playback speed. Lowering the pitch will slow down the playback speed. This can be used to match the loop length etc. of the sample to a tempo of the desired BPM value.

1. Select **Pitch BPM Adjust** to open the dialog box.

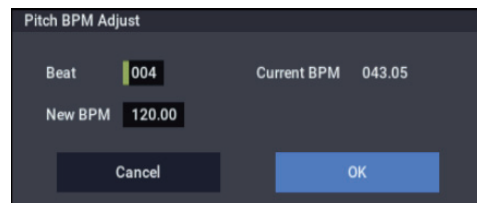

2. Specify **Beat**. This is specified in quarter-note beats.
3. **Current BPM** will show the BPM value at the base key (displayed in green). This BPM value is calculated automatically from the start address to the end address of the sample (if looping is off) or from the loop start address to the end address (if looping is on).

For example if the start and end address of the sample are two seconds apart, the original key is specified as the base key, and **Beat** is set to 4, **Current BPM** would be 120.00. If **Beat** is set to 2, the display would indicate **Current BPM** as 60.00.

It is not possible for this display to exceed the range of 40.00–480.00.

4. In **New BPM** specify the BPM value that will result from the conversion of the **Current BPM** value.
5. To execute the **Pitch BPM Adjust** command, press the **OK** button. To cancel, press the **Cancel** button.

When you execute this command, the **Pitch** (3–1b) value will be set automatically. For example if you modify a

quarter-note 120 BPM sample to 240 BPM, the **Pitch** will be set to +12.00.

 This calculation is performed within the NAUTILUS's limits of precision. Minor discrepancies may occur in the final BPM calculation.

Copy Insert Effect

For more information, please see “Copy Insert Effect” on page 122.

Swap Insert Effect

For more information, please see “Swap Insert Effect” on page 123.

Insert IFX Slot

For more information, please see “Insert IFX Slot” on page 123.

Cut IFX Slot

For more information, please see “Cut IFX Slot” on page 124.

Clean Up IFX Routings

For more information, please see “Clean Up IFX Routings” on page 124.

Copy MFX/TFX

For more information, please see “Copy MFX/TFX” on page 125.

Swap MFX/TFX

For more information, please see “Swap MFX/TFX” on page 125.

Write FX Preset

For more information, please see “Write FX Preset” on page 126.

GLOBAL mode

GLOBAL > Basic Setup

In GLOBAL mode you can make settings that affect the entire instrument, such as master tuning, MIDI, and memory protect.

You can also edit user scales, Drum Kits, Wave Sequences and Arpeggio.

⚡ If you want settings made in GLOBAL mode to persist after the power is turned off, you must write them into memory. To do so, use the menu commands **Write Global Setting**, **Write Drum Kit**, **Write Wave Sequence**, or **Write Arpeggio Patterns**.

0-1: Basic



In this page you can adjust the master tuning, turn all effects on/off, make overall system settings such as bank map and system lock, and make memory protect settings.

0-1a: Basic

Master Tune [-50cent (427.47Hz)... +50cent (452.89Hz)]

This adjusts the overall tuning of the entire NAUTILUS in one-cent units, over a range of ± 50 cents. (A cent is 1/100 of a semitone.) At the default of 0, A4 = 440 Hz.

⚡ The value shown for A4's frequency assumes that the scale is set to Equal Temperament. If a different scale is selected, the actual frequency of A4 may be different.

MIDI **Master Tune** can be controlled by the MIDI Master Fine Tuning message, on the Global **MIDI Channel**. This is a Universal System Exclusive message, with the format (F0, 7F, nn, 04, 03, vv, mm, F7: nn=MIDI channel, vv/mm= value).

Additionally, MIDI RPN Fine Tune messages can add to and subtract from the pitch specified by **Master Transpose**. In PROGRAM mode, this works on the Global **MIDI Channel**; in COMBINATION and SEQUENCER modes, it can be controlled separately for each MIDI channel. For more information, see "Using RPN (Registered Parameter Numbers)" on page 935.

Key Transpose [-12...+00...+12]

This adjusts the pitch in semitone steps over a ± 1 octave range.

Note: You can change this setting by holding down the SHIFT button and pressing the OCTAVE +/- buttons.

Octave : -2 ... 0 ... +2

Moves the pitch of the NAUTILUS up or down, in octaves.

Note: The way that **Key Transpose** works is affected by the **Convert Position** setting. If **Convert Position** is set to Pre MIDI, **Key Transpose**, **Octave** will affect MIDI note numbers transmitted from the NAUTILUS. For more information, see "Convert Position" on page 652.

| Keys/Transpose | -12 | 0 | +12 |
|----------------|----------------------|-----------------------|-----------------------|
| 61 keys | 24...84 (C1...C6) | 36...96 (C2...C7) | 48...108 (C3...C8) |
| 73 keys | 16...88 (E0...E6) | 28...100 (E1...E7) | 40...112 (E2...E8) |
| 88 keys | 9...96 (A-1...C7) | 21...108 (A0...C8) | 33...120 (A1...C9) |

Note: Use the OCTAVE +/- buttons to change this setting.

MIDI **Key Transpose** can be controlled by the MIDI Master Coarse Tuning message, on the Global **MIDI Channel**. This is a Universal System Exclusive message, with the format (F0, 7F, nn, 04, 04, vv, mm, F7: nn=MIDI channel, vv/mm=value).

Additionally, MIDI RPN Coarse Tune messages can add to and subtract from the pitch specified by **Key Transpose**. In PROGRAM mode, this works on the Global **MIDI Channel**; in COMBINATION and SEQUENCER modes, it can be controlled separately for each MIDI channel. For more information, see “Using RPN (Registered Parameter Numbers)” on page 935.

Osc/Timbre/Track Transpose
[Works Within Scale (for harmonies), Transposes Scale]

This parameter determines how the Program Oscillator, Combination Timbre, and Song Track Transpose parameters interact with the Scale and Key.

Works Within Scale (for harmonies) means that transposition uses intervals within the current scale. This option works well if you are using non-equal-tempered scales and want to build parallel intervals (such as “fat fifths”) into your sounds. For example, let’s say that you are using Just Intonation in the key of C. If you transpose one of the Timbres up by 7 semitones and play a C, the result will be two notes: C, and G 2 cents sharp (the Just Intonation fifth).

Transposes Scale means that the Scale’s Key changes to match the transposition. This option is useful if you play in non-equal-tempered scales and transpose entire songs—to accommodate singers, for example. In other words, let’s say that the Scale Key is set to C, and the third note of the scale (E) is 50 cents flat. If you transpose up by 2 semitones, and play an E, the result will be an F# 50 cents flat—still the third note of the scale. For this application, it’s also best to set the **Convert Position** to **Post MIDI**; for more information, see “Convert Position” on page 652.

Velocity Curve **[1...9]**

This specifies the way in which the volume and/or tone will change in response to variations in keyboard playing dynamics (velocity). Choose the curve that is most appropriate for your playing strength and style, and the effect that you wish to produce.

When **Convert Position** (1–1a) is Pre MIDI, variations in keyboard playing dynamics will affect the velocity effect and the transmitted velocity data as shown in the left-hand diagram below.

Incoming data will automatically use the velocity curve number 4 shown in the right-hand diagram.

With a setting of Post MIDI, variations in keyboard playing dynamics (and in the velocity of incoming data) will respond as shown in the right-hand diagram below. If you are playing NAUTILUS’s tone generator from an external keyboard or sequencer, and the overall sound is too bright or too dark, you can set the **Convert Position** parameter to Post MIDI and select the appropriate velocity curve here.

For the transmitted data, the velocity curve number 4 shown in the left-hand diagram will automatically be selected.

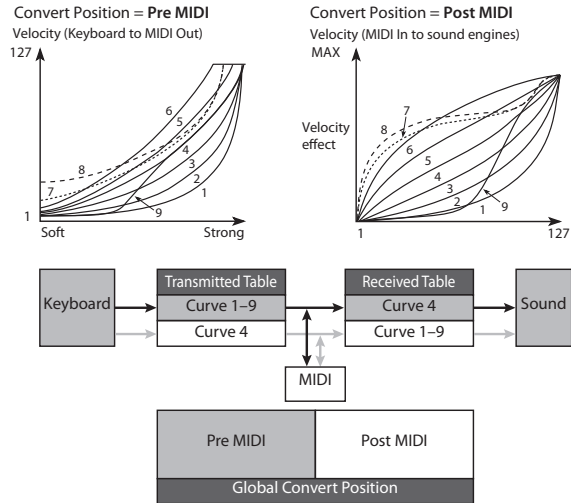

- 1, 2, 3: An effect will be obtained for strongly-played notes
- 4: This is the default curve
- 5, 6: An effect will be obtained even if you do not play very strongly
- 7: A certain amount of effect will be obtained even for softly-played notes
- 8: This curve produces the most regular effect. This setting is suitable when you do not need velocity sensitivity, or when you wish to make the notes more consistent. However with this curve, control of softly-played notes will be more difficult.
- 9: This curve is designed specifically for playing piano sounds from the weighted RH3 keyboards in the 73-note and 88-note models.

Aftertouch Curve (MIDI IN) **[1...8]**

This specifies the way in which incoming aftertouch data will affect the volume or tone when **Convert Position** (GLOBAL 1–1a) is set to Post MIDI.

Aftertouch This setting has no effect when **Convert Position** (GLOBAL 1–1a) is set to Pre MIDI.

This curve is applied immediately before the tone generator. The **aftertouch Curve** setting selects the curve that is applied to the incoming aftertouch.

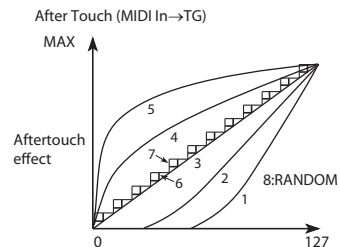

- 1, 2: This curve produces change when strong aftertouch pressure is applied.
- 3 (Normal): The normal curve.
- 4, 5: This curve produces change even when light pressure is applied.
- 6, 7: These curves produce change in 24 or 12 steps. Curve number 7 allows change over twelve steps, so when using aftertouch to modify the pitch, you can set the range of modification to one octave, and use aftertouch to vary the pitch in semitone steps.

8: This is a random curve. Use this when you wish to create special effects, or to use aftertouch to apply unpredictable modulation.

MIDI With a setting of aftertouch, the setting you make here will be applied immediately before the NAUTILUS's internal tone generator, meaning that it will affect the data received via MIDI, but will not affect the transmitted data.

0-1b: Effect Global SW

IFX1-12 Off [Off, On]

On (checked): All insert effects IFX1-12 will be off.

Off (unchecked): The IFX settings for **IFX1 On/Off-IFX12 On/Off** in PROGRAM, COMBINATION, SEQUENCER, and SAMPLING modes will be valid.

MFX1&2 Off [Off, On]

On (checked): Master Effect1 and 2 (MFX1, 2) will be off.

Off (unchecked): The Master/Total Effect setting **MFX1 On/Off**, and **MFX2 On/Off**, in PROGRAM, COMBINATION, and SEQUENCER modes will be valid.

Note: You can use the MFX button to change this setting.

TFX1&2 Off [Off, On]

On (checked): Total effects 1 and 2 (TFX1, 2) will be off.

Off (unchecked): The **TFX1 On/Off** and **TFX2 On/Off** settings in the Master/Total Effect page of PROGRAM, COMBINATION, SEQUENCER, or SAMPLING modes will be used.

Note: You can use the TFX button to change this setting.

MIDI When **IFX1-12 On/Off**, **MFX1&2 On/Off**, or **TFX1&2 On/Off** settings are switched, control change messages CC#92 (effect control 2), CC#94 (effect control 4), and CC#95 (effect control 5) will be transmitted respectively. The transmitted data will be 0 for off, and 127 for on.

0-1c: ARP/DRUM

All ARP Off [Off, On]

On (checked): All Arpeggiator functionality will be disabled. ARP will not play even if the ARP button is on.

Off (unchecked): Arpeggiator will play normally, based on the ARP button setting.

All Drum Off [Off, On]

On (checked): All Drum functionality will be disabled. The Drum will not play even if the DRUM button is on.

Off (unchecked): The Drum will play normally, based on the DRUM button setting.

Click: ON/OFF

This turns the click sound on/off. You can also turn this on/off by holding down the SHIFT button on the front panel and pressing TAP.

The click sound cannot be turned on in SEQUENCER mode.

Level: 0...127

Sets the click volume.

0-1d: System Preference

Bank Map [Korg, GM(2)]

This configures the sound mapping for Programs and Combinations in relation to bank select program change messages (CC#0: high position byte; CC#32: low position byte).

The bank select messages corresponding to Program banks A-T, G, g (1)-g (9), g (d) and combination banks A-N are received (R) or transmitted (T), according to the table below.

| Bank | Bank Map: KORG | Map: GM(2) |
|-------------|---------------------|------------------------------|
| A | 00.00 R/T | 63.00 R/T |
| B | 00.01 R/T | 63.01 R/T |
| C | 00.02 R/T | 63.02 R/T |
| D | 00.03 R/T | 63.03 R/T |
| E | 00.04 R/T | 63.04 R/T |
| F | 00.05 R/T | 63.05 R/T |
| G | 00.08 R/T | 63.08 R/T |
| H | 00.09 R/T | 63.09 R/T |
| I | 00.10 R/T | 63.10 R/T |
| J | 00.11 R/T | 63.11 R/T |
| K | 00.12 R/T | 63.12 R/T |
| L | 00.13 R/T | 63.13 R/T |
| M | 00.14 R/T | 63.14 R/T |
| N | 00.15 R/T | 63.15 R/T |
| O | 00.16 R/T | 63.16 R/T |
| P | 00.17 R/T | 63.17 R/T |
| Q | 00.18 R/T | 63.18 R/T |
| R | 00.19 R/T | 63.19 R/T |
| S | 00.20 R/T | 63.20 R/T |
| T | 00.21 R/T | 63.21 R/T |
| GM | 121.00 R/T, 56.00 R | 121.00 R/T, 56.00 R, 00.00 R |
| g(1)...g(9) | 121.01...09 R/T | 121.01...09 R/T |
| g(d) | 120.00 R/T, 62.00 R | 120.00 R/T, 62.00 R |

The respective bank types are listed below.

| Bank | Bank Type |
|-----------------------|--|
| A...E, P...R | Selectable banks of HD-1, EXi (default: EXi) |
| F...O, S, T | Selectable banks of HD-1, EXi (default: HD-1) |
| GM, g(1)...g(9), g(d) | HD-1-GM2 program bank GM: GM2 capital programs, g (1)...g (9): GM2 variation programs, g (d): GM2 drum programs |

Set banks A-T using the "Set Program Bank Type" page menu command.

 Use caution in MEDIA mode, since the bank data will be overwritten when you load data of different bank types from a PCG file.

 When receiving MIDI system exclusive messages or a Program data dump, only data with the same bank type will be received. Data using different bank types will not be received. Use "Set Program Bank Type" to change the bank type before receiving the data dump.

Power On Mode [Reset, Memorize]

Specifies the condition at power-on.

Reset: The NAUTILUS will be in COMBINATION mode P0: Play, and Combination INT–A000 will be selected.

Memorize: The location (mode and page) where you were when the power was last turned off, and the last-selected program or combination number will be selected.

 This function does not memorize the contents of any parameters that were edited. Before turning off the power, be sure to write your data or save it in MEDIA mode.

Internal Headroom [Standard, +12dB, +24dB, +36dB, +48dB]

NAUTILUS uses 32-bit floating point processing, resulting in an outstanding internal dynamic range of about 1,500dB. This means that internal signals can get both very loud and very soft without any noticeable decrease in audio quality. For instance, you don't need to worry about turning down the oscillator level before entering a highly resonant filter, or be too concerned about maximizing every gain stage.

Audio input and output, on the other hand, uses industry-standard 24-bit fixed-point A/D and D/A converters. As with all such converters, these have a theoretical maximum dynamic range of 144dB, and the loudest level they can produce is referred to as 0dBfs. If they try to produce a louder signal, they will clip at 0dBfs (and sound bad!).

The Internal Headroom parameter helps to control the way in which the internal 1,500dB dynamic range interacts with the audio I/O's theoretical 144dB dynamic range.

To prevent internal signal levels from becoming so high that they completely saturate the D/A converters, the system intentionally limits the maximum signal level at the inputs to IFX1–12, MFX1/2, and TFX1/2. Internal Headroom sets the volume level at which this limiting happens, relative to the D/A's maximum level of 0dBfs.

When this is set to Standard, signals in the FX Busses are limited to the clip point of the D/As. To avoid internal clipping, you can turn down the output of the voice (using EQ Input Trim, for instance), or turn down the inputs or outputs of individual effects.

When Internal Headroom is set to +12dB, +24dB, +36dB, or +48dB, the FX Bus signals are allowed to be higher than the maximum D/A levels. This means that there is less chance of clipping internally, so that you don't need to be as concerned about gain-staging between individual effects. However, you still need to make sure that the signal level is 0dBfs or below before reaching the final outputs.

Hold Time [0...60 seconds]

Hold Time controls the duration of Smooth Sound Transitions. It sets how long reverbs, delays, and note releases continue to ring out after a new sound has been selected. The timer starts after all notes from the previous sound are no longer being held down, and the sustain pedal is released.

Individual Set List Slots can override this global setting with specific **Hold Times**, if desired; see "Hold Time" on page 567.

For more information, see "Smooth Sound Transitions" on page 121 of the OG.

Knob Mode [Jump, Catch]

This specifies how the front panel RT control knobs 1–6 will operate.

When you switch programs, combinations, or songs, the saved or default values will be recalled to the NAUTILUS's RT control knobs 1–6. In the same way, when you use SELECT button to switch the function of the knobs, the value of these functions will be recalled and shown. At this time, the actual knob locations may not necessary match the recalled values. The "Knob Mode" setting specifies the point at which the value will begin changing when you move a knob in such a situation.

Jump: The value will immediately change to the knob location as soon as you move the knob.

Catch: The value will begin changing only when you have moved the knob to the position that matches the current value.

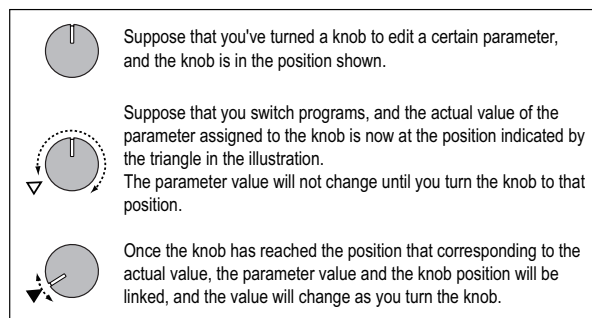

Note: When ARP/DRUM is selected with the SELECT button, the RT control knob 6 (TEMPO) will always operate as "Jump", even if it is set to "Catch".

Note: When USER is selected with the SELECT button and a Mixer parameter is set for the RT control knob, the knob will always operate as "Jump", even if it is set to "Catch".

Mute Mode [Studio, Live]

This parameter, new in NAUTILUS software version 2.1, controls the behavior of Timbre Mute in Combinations and Track Mute in Songs, including the on-screen Mute buttons. The specific effects are different depending on whether you are in COMBINATION mode or SEQUENCER mode.

Mute Mode in COMBINATION mode

Studio: Mutes control audio output of Timbres. It is particularly useful for sound design, since you can mute and un-mute Timbres without re-triggering notes.

Live: Mutes control MIDI input to Timbres. This is useful for live performance, since it allows you to create a set of Timbres for layering (such as piano, strings, and a pad), and then use the Mute buttons to enable and disable the layers as desired, without using polyphony for the muted layers.

Note: If the Timbre uses an EXi with fixed resources, those resources will continue to use processing power. If the Timbre is a CX-3, and the **Noise Level** parameter is non-zero, the noise will continue to sound. For more information, see "Noise Level" on page 186.

Mute Mode in SEQUENCER mode

Studio: Mutes control only sequencer MIDI input to Tracks; keyboard routing to Tracks is unaffected. It's convenient while working on Songs - for instance, if you want to try out a different part for a previously recorded track.

Live: Mutes control both keyboard and sequencer MIDI input to Tracks. This is useful for layering in live performance, as described under “Mute Mode in COMBINATION mode,” above.

Beep Enable [Off, On]

On (checked): A beep will be heard when you press an object in the LCD screen.

Auto Optimize RAM [Off, On]

When sampling to RAM, this controls whether or not the sample memory (RAM) will be optimized after data is written.

Optimization rearranges any unused memory areas so that all of the remaining memory can be used.

On (checked): RAM will automatically be optimized when sampling ends.

With this setting, you will always be able to sample without wasting RAM, but the sound will stop when sampling ends. If a song was playing in SEQUENCER mode, the playback will stop.

Off (unchecked): RAM will not be optimized when sampling ends. Since the sound will not stop when sampling ends, this setting is convenient when you want to consecutively sample several sections while a song plays or while listening to an input source such as a CD.

If **Auto Optimize RAM** is Off and unused areas have accumulated in memory, you can use the **Optimize RAM** menu command to perform the same function manually. For more information, see “Optimize RAM” on page 114.

The remaining amount of sample memory can be checked in SAMPLING mode. For more information, see “0-1f: Free Sample Memory/Locations” on page 579.

Bit Depth

Audio Track Rec [16-bit, 24-bit]

This sets the bit depth for newly recorded audio tracks. It does not alter previously recorded tracks.

24-bit files offer higher fidelity, but take up 50% more space on drive.

- SEQUENCER > Home– Recording Setup “Bit Depth” (→p.458)

Sample to Disk [16-bit, 24-bit]

This sets the bit depth for sampling to drive. Note that this does not affect sampling to RAM. This same parameter appears on the sampling setup pages in PROGRAM, COMBINATION, SEQUENCER, and SAMPLING modes; changes in one place are reflected everywhere.

The resulting 24-bit files can be used at full resolution in audio tracks. When loaded into RAM, they are automatically converted to 16-bit data.

This parameter is linked to the parameters with the same name on the pages below, and can be edited.

- SAMPLING > Recording– Recording page (→p.578)
- PROGRAM > Home– Sampling page
- COMBINATION > Home– Sampling page
- SEQUENCER > Home– Sampling Setup page

Play Page Overview

Show MS/WS/DKit Graphics [Off, On]

HD-1 Programs can show a graphic on the Home page, instead of the Multisample, Wave Sequence, or Drum Kit names. Each Program controls which graphics to show, or whether to show the names instead. For more information, see “1-1h: Play Page MS/WS/DKit Display” on page 40.

This parameter provides a global override for the per-Program settings, if you’d prefer to always see the names rather than the graphics. It mirrors the Program menu item “Show MS/WS/DKit Graphics” on page 113. Changes to this parameter are reflected in the menu item, and vice-versa.

On (checked): Graphics will be shown or not, according to the Program’s settings.

Off (unchecked): Regardless of the Program’s settings, the Multisample, Wave Sequence, or Drum Kit names will be shown.

Level Meters Off [Off, On]

This option disables the level meters for Oscillators, Timbres, Tracks, audio inputs, IFX/MFX/TFX, and Master Volume.

In some cases, the level meters may slightly decrease polyphony. If this occurs, enable the **Level Meter Off** option.

0-1e: Memory Protect

Program [Off, On]

This setting protects the internal program memory.

On (checked): Internal program memory will be protected, and the following write operations cannot be performed.

- Writing a program
- Loading program data from drive
- Receiving program data via MIDI data dump

Off (unchecked): Data can be written to internal program memory.

Combination [Off, On]

This setting protects the internal combination memory.

On (checked): Internal combination memory will be protected, and the following write operations cannot be performed.

- Writing a combination
- Loading combination data from drive
- Receiving combination data via MIDI data dump

Off (unchecked): Data can be written to internal combination memory.

Song [Off, On]

This setting protects the internal song memory.

However, when the power is turned off, the song data in song memory will be lost regardless of this setting.

On (checked): Internal song memory will be protected, and the following write operations cannot be performed.

- Recording to the sequencer
- Loading song data from drive
- Receiving song data via MIDI data dump

Off (unchecked): Data can be written to internal song memory.

Set List [Off, On]

Specifies whether the set list memory will be protected.

On (checked): The following data cannot be written to or read from the Combination memory of the NAUTILUS, as it is protected.

- Set lists (write)
- Set list data from the internal drive (load)
- Set list data in a MIDI data dump (receive)

Off (unchecked): You can write to the set list memory on the NAUTILUS.

Drum Kit [Off, On]

This setting protects the internal drum kit memory.

On (checked): Internal drum kit memory will be protected, and the following write operations cannot be performed.

- Writing a drum kit
- Loading drum kit data from drive
- Receiving drum kit data via MIDI data dump

Off (unchecked): Data can be written to internal drum kit memory.

Wave Sequence [Off, On]

This setting protects the internal wave sequence memory.

On (checked): The internal wave sequence memory will be protected, and the following operations will not be possible.

- Writing a wave sequence
- Loading wave sequence data from drive
- Receiving wave sequence data via MIDI data dump

Off (unchecked): You will be able to write to internal wave sequence memory.

ARP Pattern [Off, On]

Specifies whether the arpeggio pattern memory will be protected.

On (checked): The following data cannot be written to or read from the arpeggio pattern memory of the NAUTILUS, as it is protected.

- Arpeggio patterns (write)
- Arpeggio pattern data from the internal drive (load)
- Arpeggio data in a MIDI data dump (receive)

Off (unchecked): You can write to the arpeggio pattern memory of the NAUTILUS.

Internal HDD Save [Off, On]

This setting protects the internal drive.

On (checked): The internal hard disk will be protected, and the following operations will not be possible.

- Saving, copying, or deleting internal drive data in MEDIA mode
- Recording audio tracks in SEQUENCER mode
- Sampling to DISK in each mode

Off (unchecked): You will be able to write data to the internal drive.

✓ 0-1: Page Menu Commands

- Write Global Setting →p.686
- Set Program Bank Type →p.686
- Change all bank references →p.687
- Touch Panel Calibration →p.687
- Half Damper Calibration →p.687
- LCD Setup →p.688
- Update System Software →p.688
- Display Public ID →p.689
- Auto Power-Off Setting... →p.689
- Fan Control Setting →p.689
- Rear Panel Illumination Setup →p.690

- PAGE →p.126
- MODE →p.126

0-2: Audio



This page controls the default mixer settings for the audio inputs, including level, pan, effects busing, and so on. It also lets you route the main L/R outputs to a pair of individual outputs, for specific applications in live performance and recording.

0-2a: Audio Input

Each Program, Combination, and Song can either use these Global audio input mixer settings, or have its own custom settings. This is controlled by the **Use Global Settings** parameter, on the Program, Combination, or Song's Sampling page.

The default for **Use Global Settings** is **On**. This lets you change freely between different Programs, Combis, and Songs without affecting the audio inputs.

Also, any edits made in the mode's Sampling page will affect the Global setting, and vice-versa.

On the other hand, it may sometimes be convenient to save a particular mixer setup with an individual Program, Combi, or Song, to set up special sub-mixer settings or effects processing for particular inputs. For example, you can set up a Program to use a mic input with a vocoder, as described under "Vocoder (PROGRAM mode)" on page 736.

In this case, set the Program, Combi, or Song's **Use/Edit Global Setup** to **Off**, and the audio inputs will use the custom settings.

With this in mind, the Global settings apply in the following situations:

- When this page (GLOBAL Audio Input) is open.
- In PROGRAM, COMBINATION, and SEQUENCER modes, if the Sampling page's **Use Global Setting** check-box is **On**. This can be set independently for each Program, Combination, and Song.
- In other pages of GLOBAL mode, if you switch to GLOBAL mode from a Program, Combi, or Song with **Use Global Setting** set to **On**.

- Similarly, in MEDIA mode, if you switch to MEDIA mode from a Program, Combi, or Song with **Use Global Setting** set to **On**.

Audio In [On, Off]

Switches the audio input on/off. This works in tandem with the AUDIO IN button on the front panel.

Input1, Input2

These are the settings for audio inputs 1 and 2.

USB 1, USB 2

This configures the digital audio input from the USB B port. Connect the digital output from your computer to the USB B port. The USB B port supports an input/output sample rate of 48 kHz.

Bus Select (IFX/Indiv.) [L/R, IFX1...12, 1...4, 1/2...3/4, Off]

This specifies the main bus routing for the input signal.

L/R: The input signal will be sent to the L/R bus.

IFX1...12: The input signal will be sent to the IFX1–12 bus. Choose one of these settings if you want to apply an insert effect while sampling.

1...4: The input signal will be sent to the specified INDIVIDUAL OUTPUT in mono. The **Pan** setting will be ignored.

1/2...3/4: The input signal will be sent in stereo (including the effect of the **Pan** control) to the specified INDIVIDUAL OUTPUT pair.

Off: The input signal will not be routed directly to the outputs or Insert Effects. However, it may still be routed to an FX Control Bus or REC Bus.

FX Ctrl Bus (FX Control Bus) [Off, 1, 2]

This sends the external audio input signal to an FX Control bus (two stereo channels; FX Ctrl 1 and 2).

For details, see “8–1d: FX Control Bus” on page 99.

REC Bus [Off, 1, 2, 3, 4, 1/2, 3/4]

This sends the external audio input signal to the REC buses (four mono channels; 1, 2, 3, 4).

Use the REC buses when you want to sample in any mode, or to record audio tracks in SEQUENCER mode. These are dedicated buses for recording.

Off: The external audio signal will not be sent to the REC buses. Normally you will use the Off setting.

1, 2, 3, 4: The external audio input signal will be sent to the specified REC bus. The **Pan** setting is ignored, and the signal is sent in monaural.

1/2, 3/4: The external audio input signal will be sent in stereo to the specified pair of REC buses. The **Pan** setting sends the signal in stereo to buses 1 and 2 or buses 3 and 4.

Send1 (to MFX1) [000...127]

Send2 (to MFX2) [000...127]

These adjust the levels at which the audio input is sent to the master effects.

Send1 (to MFX1): Send the signal to master effect 1.

Send2 (to MFX2): Send the signal to master effect 2.

This setting is ignored if **Bus Select** is other than L/R or Off.

If **Bus Select (IFX/Indiv.)** is set to IFX1–12, the send levels to the master effects are set by the post-IFX1–12 **Send1** and **Send2** (PROGRAM, COMBINATION, SEQUENCER 8–5a).

 Set “Bus Select (IFX/Indiv.)” to any setting besides off, and then raise the “Level” value to input the sound from the external input into the NAUTILUS. When you do this and connect audio cables to the AUDIO INPUT 1/2 jacks, the noise component of the audio signal may go through the ADC and into the NAUTILUS even if there is no audio input, and then be output from AUDIO OUTPUT L/R and to (INDIVIDUAL) 1–4. When you are not using external inputs, turn “Bus Select (IFX/Indiv.)” off, or set the “Level” to “0”.

Similarly, when you are not using the USB B port, turn “Bus Select (IFX/Indiv.)” off, or set the “Level” to “0”. This also applies to the “REC Bus” and “FX Control Bus”. If you are not using these buses, turn them off.

Mute [Off, On]

Turns on/off mute for the external audio signal being inputted.

Off: The external audio signal will be input as specified by the various parameters.

On: The external audio signal will be muted (silent), and will not be input.

Solo [Off, On]

Turns on/off Solo for the external audio signal being input. It does this by temporarily muting all non-soloed channels.

In GLOBAL mode, the way in which Solo operates depends on the setting of the **Exclusive Solo** menu command in the previously selected mode.

Exclusive Solo Off: Multiple channels can be soloed. The solo status will change each time you press Solo.

Exclusive Solo On: When you press Solo, only that channel will be soloed.

 The Solo setting is not saved when you Write.

Pan [L000...C064...R127]

This specifies the panning of the external audio input signal. With a stereo audio source, you will normally set the inputs to L000 and R127 respectively.

Level [000...127]

This controls the level of the external audio signal. The default is 127.

The meter to the left of the slider shows the audio input volume, before the Level control, in realtime.

Avoiding distortion

The analog signal from AUDIO INPUTS 1 & 2 is converted to a digital signal by an A/D converter. The **Level** parameter sets the volume immediately after the conversion into digital form.

Because of this, it’s best to optimize the analog signal level first, and then make fine adjustments via the **Level** parameter if necessary. You can control the analog level by adjusting the Analog Input Setup, or the output level of the external audio source.

This also means that if the sound is distorting because the analog signal is too loud, adjusting the **Level** setting won’t help. If you hear unwanted distortion, try adjusting the analog levels as described above.

Avoiding extraneous noise

If cables are connected to AUDIO INPUTS 1 & 2, any noise carried by the cables will enter into the NAUTILUS mixer structure. This may include hiss, hum, and other audio noise.

To avoid noise from unused audio inputs, either:

- Set the input’s **Level** to 0
or
- Set all of the bus assignments to Off, including **Bus Select (IFX/Indiv. Out Assign)**, **REC Bus**, and **FX Control Bus**

If no audio cables are connected to the inputs, the signals are forced to zero, preventing any additional noise.

0–2b: Audio Output

L/R Bus Indiv. Assign [Off, 1/2, 3/4]

This lets you send the L/R output to any pair of individual outputs, in addition to all of the normal L/R outputs (including the main L/R outputs, the HEADPHONE jack, and USB outputs).

In studio or live performance situations, you can use this parameter to monitor sounds in privacy, without changes at the main board.

Off: The L/R output will be sent to the normal outputs only (as described above).

1/2, 3/4: The L/R output will be sent to the corresponding pair of INDIVIDUAL OUT 1–4 jacks, as well as to all of the normal outputs.

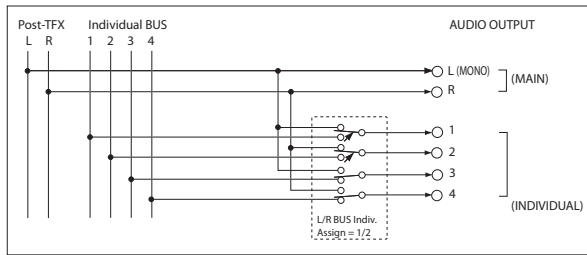

Private monitoring

On stage, or in the studio, it can be convenient to audition sounds or make edits without sending the signal to the mixer, or to the main monitors. You can use **L/R Bus Indiv. Assign** to do this:

1. **Connect Individual Outputs 1/2 to the mixer or main monitors. Do not connect the main L/R outputs.**

You can actually use either of the individual output pairs, but we'll talk about 1/2 in this example.

2. **While you're auditioning sounds or editing, set L/R Bus Indiv. Assign to Off.**

3. **Use the built-in headphone output for listening to NAUTILUS as you select or edit sounds.**

As an alternative, you can connect the main L/R outputs to your personal monitor mixer.

4. **When you're ready for others to hear the results, set L/R Bus Indiv. Assign to 1/2.**

Now, the NAUTILUS stereo mix will go to the main board.

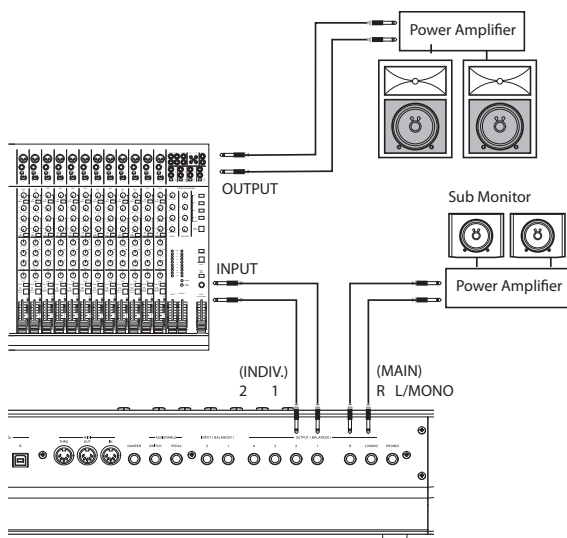

0-2c: Analog Setup



Input Select

Sets the specified level of the input signal. Switch this to match the device that is connected, and use Analog Input Gain to adjust the gain.

LINE: Set this to "LINE" when you want to connect a mixer, computer, audio. system, signal processor or another synthesizer. The specified level is +4 dBu, with 12 dB of headroom.

MIC: Use the "MIC" setting if you are connecting a mic.

Analog Input Gain

Use this to fine-tune the gain after setting the gain in "Input Select".

When Input Select is set to "LINE", the "MIN" position equals unity gain.

The MAX position is about 40 dB higher than the MIN setting.

✓ 0-2: Page Menu Commands

- Write Global Setting →p.686
- Set Program Bank Type →p.686
- Change all bank references →p.687
- Touch Panel Calibration →p.687
- Half Damper Calibration →p.687
- LCD Setup →p.688
- Update System Software →p.688
- Display Public ID →p.689
- Auto Power-Off Setting... →p.689
- Fan Control Setting →p.689
- Rear Panel Illumination Setup →p.690

- PAGE →p.126
- MODE →p.126

0-3: KSC Auto-Load

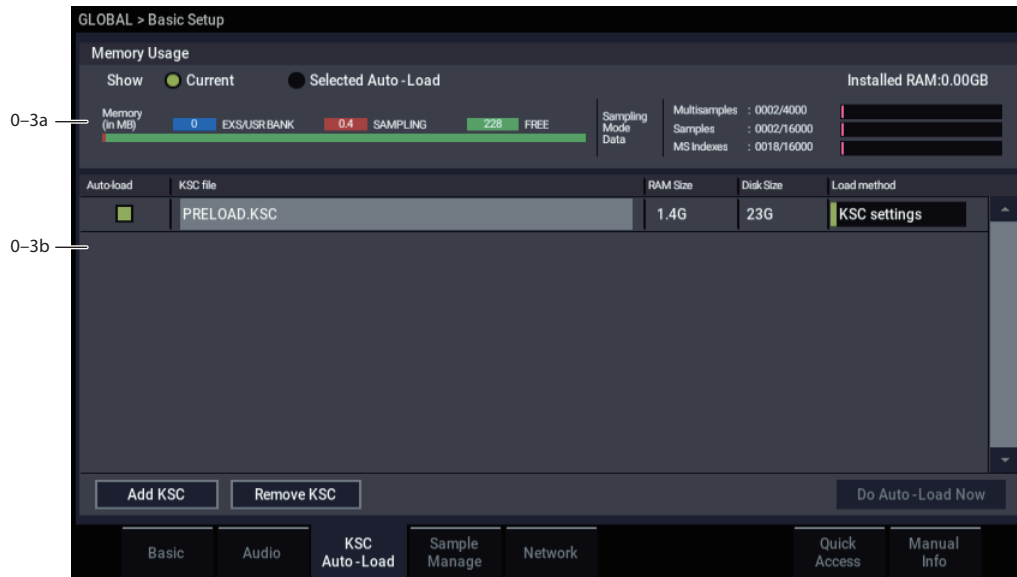

Overview

KSC stands for Korg Sample Collection. KSC files contain links to RAM and/or EXs sample data, including Multisamples, Samples, and Drum Samples. Loading a KSC file loads all of the linked sample data.

At startup, the NAUTILUS can automatically load one or more KSC files. This page lets you select which KSC files are loaded. These settings are saved automatically, and are not part of the GLOBAL PCG file.

Adding a KSC to the list

To add a KSC to the list:

1. Press the **Add KSC** button.

The Add KSC dialog appears, allowing you to select KSC files from disk. For details, see “Add KSC” on page 641.

2. Select the desired KSC files.
3. Press **OK**.

The selected KSC files will be added to the list.

Removing a KSC from the list

To remove a KSC from the list:

1. Select the KSC file that you’d like to remove.
2. Press the **Remove KSC** button.

A confirmation dialog appears:

Are you sure?
[Cancel] [OK]

3. Press **OK**.

The KSC file will be removed from the list.

 Do not turn off the power for at least 10 seconds after adding or removing KSCs, or making any other changes to the auto-load settings. This allows the system time to complete the process, which includes saving the settings to the internal drive.

Applying changes immediately

Normally, changes only take affect after the next restart. To load and un-load KSCs immediately:

1. Press the **Do auto-load now** button.

A confirmation dialog appears. For details, see “Do auto-load now” on page 642.

2. Press **OK**.

Any changes you’ve made by adding or removing KSC files will be applied, with sample data loaded and un-loaded as necessary. Note that this may take some time to complete.

0-3a: Memory Usage

This shows the amount of memory used by the different types of samples, along with the slots used for SAMPLING mode Multisamples, Samples, and Multisample Indexes (key zones within Multisamples).

Show [Current, Selected Auto-Load]

This selects whether the graphic shows the current state of memory, or the state of memory as it would be after doing an auto-load using the current settings.

It’s possible for different KSC files to refer to the same sample data; for instance, two KSC files may point to the same set of Grand Piano multisamples. In this case, the redundant data is counted only once.

EXS/USR BANK

This shows the amount of memory used for EXs and User Sample Banks.

SAMPLING

This shows the amount of memory used for data in SAMPLING mode.

FREE

This shows the amount of memory still available.

SAMPLING mode Data

Multisamples [nnnn/4,000]

This shows the number of Multisamples in SAMPLING mode, out of the maximum of 4,000.

Samples [nnnn/16,000]

This shows the number of Samples in SAMPLING mode, out of the maximum of 16,000.

MS Indexes [nnnn/16,000]

This shows the total number of Indexes in all Multisamples in SAMPLING mode, out of the maximum of 16,000.

Over indications

There are various indications if the selected data exceeds any of the following.

Memory capacity exceeded

If the size of the sample data in MB adds up to greater than the total available memory, then there are several indications in the graphic:

- The **Free** box turns red, and shows the amount by which the selected data exceeds the available memory, as a negative number
- The word **OVER** appears in red to the right of the Free box, with three exclamation points on a second line

Max numbers exceeded for SAMPLING mode Multisamples, Samples, or indexes

SAMPLING mode can have up to 4,000 Multisamples, 16,000 Samples, and 16,000 indexes in Multisamples. If any of these limits would be exceeded by the selected auto-load, then there are two indications in the graphic:

These maximums apply only to SAMPLING mode; ROM, EXs, and User Sample Banks do not count towards these totals.

- The numbers for the affected data type (e.g., number of SAMPLING mode Samples) are shown in red
- The bar-graph for the data type turns red, instead of blue, and extends to fill the entire length

0–3b: List of KSCs

This list shows the KSCs available for auto-loading. To add or remove KSC files from this list, use the **Add KSC** and **Remove KSC** buttons below the list; for more information, see “Add KSC” on page 641 and “Remove KSC” on page 641. Each KSC in the list has several parameters, as detailed below.

If a KSC is loaded in MEDIA mode, it is automatically added to the list on a temporary basis. If you then check the KSC’s **Load** check-box, the KSC is added to the list just as if it had been added by using **Add KSC**. If you do not check **Auto-load**, any automatically-added KSCs are cleared from the list at the next startup.

The list of KSCs is organized alphabetically.

Auto-load [Check-box]

If this box is checked, the KSC will be auto-loaded. If it is un-checked, the KSC remains in the list, but is not auto-loaded.

You can keep frequently-used KSC files in the list for easy access, and enable and disable their **Auto-load** check-boxes as desired.

KSC file [File name]

This is the name of the KSC file.

RAM size [Size in MB]

This shows the size that the KSC will use when loaded, according to the selected **Load method**.

Disk size [Size in MB]

This shows the size of the KSC on drive.

Load method [RAM, Virtual Memory, KSC settings]

The **Load Method** sets the preferred way to load the KSC’s samples: load them entirely into RAM, or use Virtual Memory.

Note that if the data is extremely large, and would not fit into RAM regardless of which other samples were loaded, the data will use Virtual Memory regardless of this setting.

These settings apply only to EXs and User Sample Bank data; SAMPLING mode data is always loaded into RAM.

RAM: The samples will be loaded into RAM. This has the advantage of allowing reverse sample playback.

Virtual Memory: The samples will use Virtual Memory. This generally allows you to load more large samples at once. Note that the samples may still require a significant amount of RAM.

KSC Settings: KSCs can store separate load method settings for each Multisample or Drum Sample, based on the settings when the KSC was saved. These settings may be viewed and edited on the Sample Management page (see “0–4: Sample Manage” on page 643). Setting **Load method** to **KSC Settings** uses these individual settings.

Add KSC 

Pressing this button brings up a file browser, similar to the popup file browser for setting the sample-to-drive location. There are two buttons below the standard file browser controls: **Cancel** and **Add**.

To add files, select one or more KSC files (you can use Multiple select to choose more than one file) and press **Add**. To exit without making any changes, press **Cancel**.

When KSCs are added to the list, their **Auto-load** check-boxes are set to On.

See also “Adding a KSC to the list” on page 640.

Remove KSC 

This button lets you remove KSCs from the list. It only affects the contents of the list; it does not affect the files themselves.

When you press the **Remove KSC** button, a confirmation dialog appears:

Are you sure?
[Cancel] [OK]

Press **OK** to remove the KSC from the list, or **Cancel** to exit without making any changes.

See also “Removing a KSC from the list” on page 640.

Do auto-load now

Pressing this button brings up a confirmation dialog:

This will erase all EXs and RAM samples, and then load the selected KSC files.

Are you sure that you want to proceed?

[Cancel] [OK]

If you press **OK**, the system clears all RAM and EXs sample data, and then goes through the auto-load process immediately. Note that this may take time to complete.

The **Do auto-load now** button is grayed out if the selected samples exceed the maximum available RAM, # of MS, # of Samples, or # of MS Indexes.

See also “Applying changes immediately” on page 640.

✓ Page Menu commands

No menu commands are available on this page.

0-4: Sample Manage

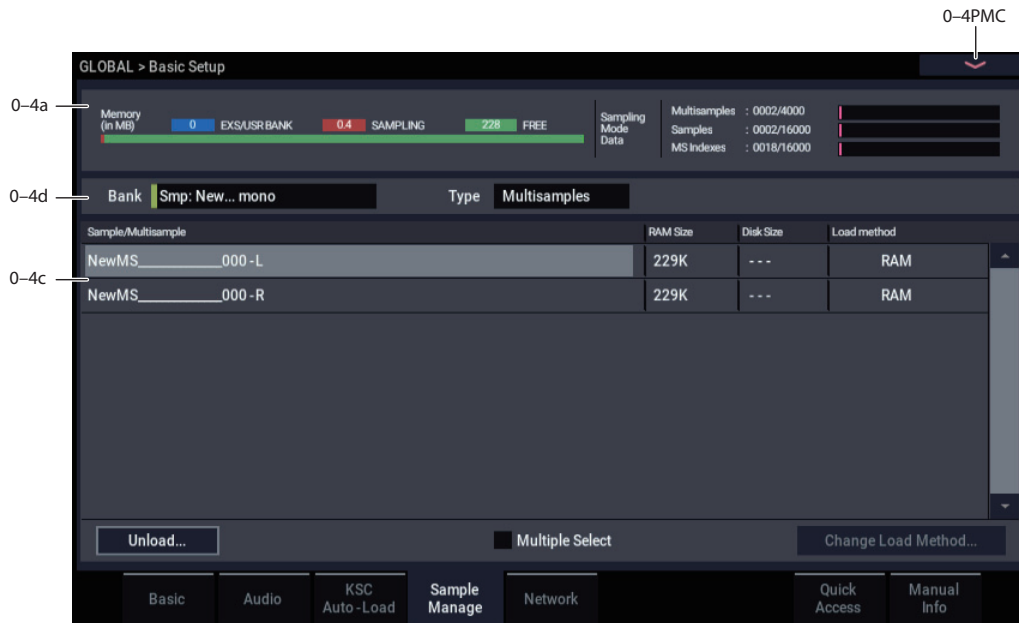

Overview

This page offers tools for managing all the loaded sample data, including SAMPLING mode, EXs, and User Sample Banks. You can:

- See an overview of memory usage
- See the loaded Multisamples, Samples, or Drum Samples for each bank
- View and change the load method (RAM or Virtual Memory) for each item in EXs and User Sample Banks
- Unload items from memory

0-4a: Memory Usage

This shows an overview of sample-related memory usage. For details, see “0-3a: Memory Usage” on page 640.

0-4b: Bank and Type select

Bank [Smp Mono, Smp Stereo, EXs1 Mono...EXs(n) Stereo, User Sample Banks]

This selects the bank to display in the list. Only banks which are loaded in whole or in part are shown.

Type [Multisamples, Samples]

This selects the type of data which will be displayed in the list. With EXs and User Sample Banks, **Samples** are equivalent to **Drum Samples**.

0-4c: Sample/Multisample

This list shows the Multisamples, Samples, or Drum Samples of the selected Bank, according to the Bank and Type selections above.

You can select individual items from the list, and then use the **Unload** or **Change load method** buttons to affect the selected items.

To select two or more items at once, enable the **Multiple Select** check-box below the list.

To select all of the items at once, use the **Select all** command in the menu.

Unload [Unload...]

This button lets you remove the selected items from memory. This does not affect the data stored on drive; it only changes what is currently loaded into memory.

Unloading individual items

To unload individual Multisamples, Drum Samples, or Samples:

1. Above the list, select the desired Bank and Type.

For EXs and User Sample Banks, the possible Types are Multisample or Drum Sample. For SAMPLING mode, the possible Types are Multisample or Sample.

2. Select the desired items (Multisamples or Samples) from the list.

To select two or more items at once, enable the **Multiple Select** check-box.

3. Press the Unload button.

A confirmation dialog will appear.

4. Press the OK button to confirm, or Cancel to exit the dialog without making changes.

Sample data may be shared by two or more Multisamples or Drum Samples. If a Sample is used only by the Multisample or Drum Sample being unloaded, the Sample will be unloaded as well. If the Sample is used elsewhere, it will stay loaded.

Unloading an entire bank of data

You can also un-load an entire bank of data at once. To do so:

1. In the menu, select the **Unload all in bank** command. The **Unload all data from selected bank** dialog will appear.
2. Select the desired bank (**SAMPLING Mode, or any EXs or User Sample Bank**).
3. Press the **OK** button to confirm, or **Cancel** to exit the dialog without making changes.

Unloading half of a stereo sound

Stereo Samples and Multisamples are made up of two linked items, one for the left channel and the other for the right channel, with names ending in -L and -R respectively. The left and right channels also may be used individually as mono sounds.

If either the left or right channel is unloaded, the item is removed from the list of stereo Samples or Multisamples. However, the remaining channel is still available as a mono sound.

Change load method

Change load method

This button lets you change how the currently selected sample data is loaded, using either RAM or Virtual Memory. Note that this has no effect on the data stored on drive.

If all of the selected samples are too large to fit into RAM, then the **Load Method** combo box will be grayed out, and the value will be set to **Virtual Memory**.

This applies only to data in EXs and User Sample Banks; it does not apply to SAMPLING mode.

Load method [No Change, RAM, Virtual Memory]

No Change: this is the default. The load method of the sample data will remain as it was before.

RAM: The sample data will be loaded into RAM.

Virtual Memory: The sample data will be loaded using Virtual Memory.

✓ 0-4: Page menu commands

- Select All →p.690
- Unload all in bank →p.690
- Remap MS/Sample Banks →p.121

- PAGE →p.126
- MODE →p.126

0-5: Network

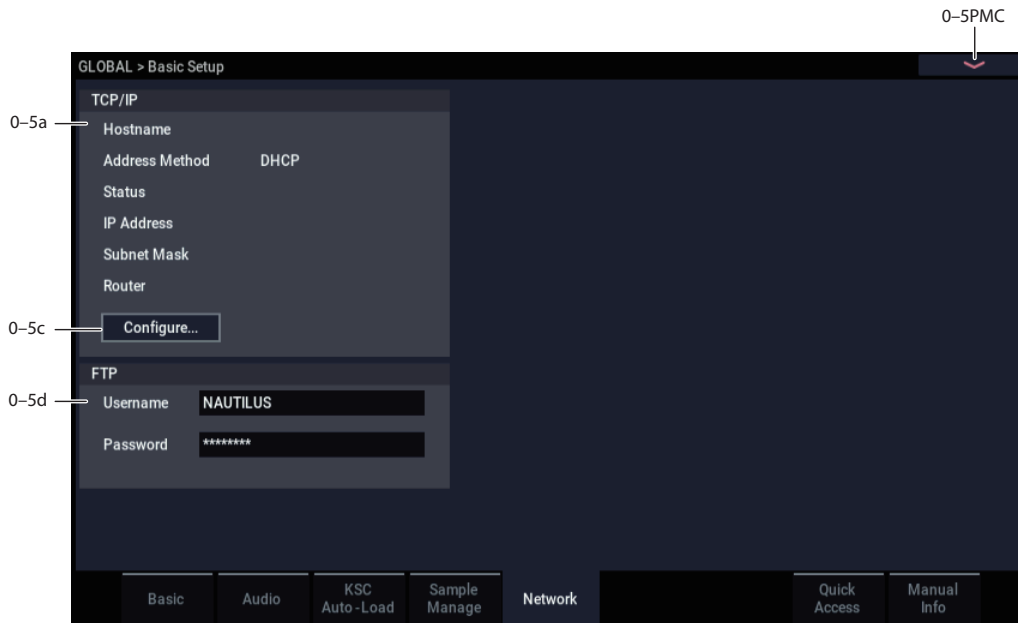

This page lets you set up the USB ethernet connection, and configure the built-in FTP server for file transfers between the NAUTILUS and your computer.

Note: Compatible USB ethernet adapter required.

The NAUTILUS supports a specific set of off-the-shelf USB Ethernet adapters. Check the Korg website for a list of compatible products.

0-5a: TCP/IP

This includes read-only displays of the current TCP/IP network settings, including the host name, address method, IP address, subnet mask, and the router's address.

For more information about what these settings mean, see "0-5c: Configure TCP/IP dialog," below. To edit these settings, press the **Configure** button.

Status [Connected, Connecting..., Disconnecting..., Cable unplugged, DHCP timed out, IP address conflict, Config failed, Off]

This shows the current state of the NAUTILUS network connection. Normal states are shown in black text, and errors are shown in red. If **Status** shows an error, see the tips under "Network Troubleshooting" on page 646.

Connected shows that the network connection is active and working properly.

Connecting... shows that the NAUTILUS is in the process of connecting to the network.

Disconnecting... shows that the NAUTILUS is in the process of disconnecting from the network, such as might happen if you change the Address Method from DHCP to Off.

Cable unplugged appears if the NAUTILUS initially connected with the network, but the cable was then physically disconnected.

DHCP timed out appears if the Address Method is set to DHCP, but the NAUTILUS has not received a response from the router (or other DHCP server). This could be caused by the cable not being connected, or by the DHCP server not working properly.

IP address conflict appears if the **Address Method** is set to **Manual** and another machine is detected on the same address.

Config failed: This indicates either that the NAUTILUS was turned on without an ethernet cable connected, or that an internal error has occurred.

Off: This will appear if the **Address Method** is set to **None (disable ethernet)**.

Configure button

Pressing this button brings up the Configure TCP/IP dialog, as described below.

0-5b: FTP

FTP stands for "File Transfer Protocol," and is a standard way to access files over networks. You can use FTP to transfer files between the NAUTILUS drive(s) and any modern computer system. If you like, you can also use an FTP client application to copy, move, and rename NAUTILUS files and folders.

When connecting to the NAUTILUS using FTP, you'll need to enter a user name and password. You can configure these with the parameters below.

User name [name]

The user name must be at least one character, and can be up to 32 characters, including letters, numbers, and dashes. The default user name is "NAUTILUS." To edit the name, press the text-entry button and enter the new name using the popup keyboard.

Password [text]

The password may be left blank, if you are not concerned about security, and can be up to 32 characters, including letters, numbers, and dashes. The default password is “NAUTILUS.” To edit the name, press the text-entry button and enter the new name using the popup keyboard

0–5c: Configure TCP/IP dialog

This dialog appears when the **Configure** button is pressed.

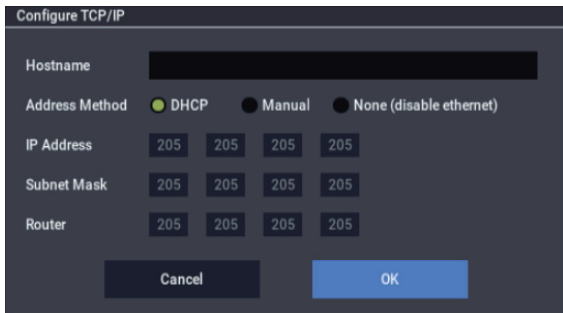

Host name [name]

This is a plain-text name to identify the NAUTILUS on the network. The name must include at least one character, and can be up to 63 characters, including letters, numbers, and dashes. The default is simply “NAUTILUS.” To edit the name, press the text-entry button and enter the new name using the popup keyboard.

Note: While the name can include dashes in the middle of the text, the first and last characters must be either letters or numbers.

Address method [DHCP, Manual, None (disable ethernet)]

DHCP: This is the default setting, recommended for general use. It allows your router to configure the NAUTILUS network settings automatically.

For those who are curious, DHCP stands for “Dynamic Host Configuration Protocol.”

Manual: This allows you to manually specify the **IP Address**, **Subnet Mast**, and **Router**. Use **Manual** only if you have specific requirements; otherwise, use **DHCP** instead.

None (disable ethernet): This allows you to disable ethernet on the NAUTILUS, even if an ethernet cable is physically connected.

OK button

Pressing the **OK** button will apply any changes to the TCP/IP settings, and then close the dialog.

Cancel button

Pressing the **Cancel** button will close the dialog without making any changes to the settings.

Manual TCP/IP settings

The **IP Address**, **Subnet Mast**, and **Router** parameters apply only if the **Address method** is set to **Manual**. Otherwise, these parameters are grayed out.

A detailed discussion of TCP/IP is outside the scope of this manual. If you need more information about how to configure the TCP/IP settings, see the documentation for your router or other network equipment.

IP Address [numeric address]

This is a unique number which identifies the NAUTILUS on the ethernet network.

Subnet Mask [numeric address]

A subnet is a range of IP addresses. Subnets can be used to create virtual divisions within a larger network, to optimize network traffic. The **Subnet Mask** helps to differentiate between traffic on the local subnet and traffic on the wider network.

In simple networks, such as those in homes or moderately-sized businesses, the **Subnet Mask** should generally be set to 255.255.255.0.

Router [numeric address]

This is a unique number which identifies your router on the ethernet network.

Network Troubleshooting

If the **Status** shows an error, try the following:

1. **If possible, use DHCP instead of manual addressing.**
2. **Make sure that all ethernet cables are connected properly.**

If possible, it’s sometimes helpful to swap the cables themselves.

3. **Try restarting the DHCP server (usually, this will be the network router).**

After the steps above, make the NAUTILUS attempt to reconnect to the network by opening and closing the **Configure TCP/IP** dialog:

4. **Press the **Configure** button to open the **Configure TCP/IP** dialog.**
5. **Press **OK** to close the dialog.**

The NAUTILUS will then attempt to reconnect to the network; watch the **Status** parameter to see its progress.

✓ 0–5: Page Menu Commands

- Write Global Setting →p.686
- Set Program Bank Type →p.686
- Change all bank references →p.687
- Touch Panel Calibration →p.687
- Half Damper Calibration →p.687
- LCD Setup →p.688
- Update System Software →p.688
- Display Public ID →p.689
- Auto Power-Off Setting... →p.689
- Fan Control Setting →p.689
- Rear Panel Illumination Setup →p.690
- PAGE →p.126
- MODE →p.126

0-8: Quick Access

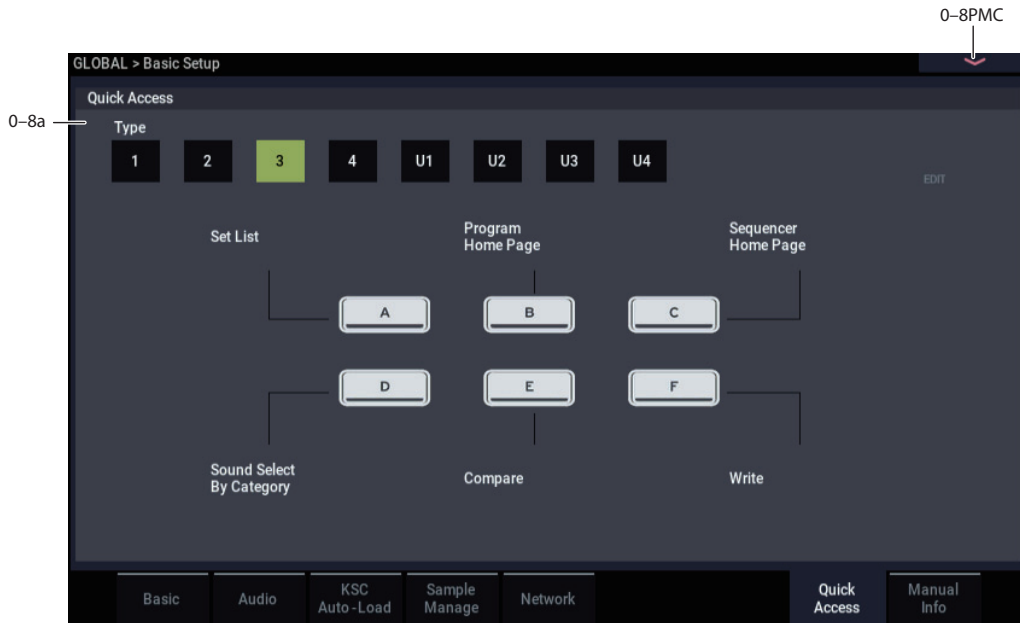

This assigns the operations to the Quick Access A through F buttons on the front panel. You can select from one of four templates to assign.

0-8a: Quick Access

Type [1, 2, 3, 4, U1, U2, U3, U4]

This assigns the operations to the Quick Access A through F buttons on the front panel. Select one of the four templates for the function to assign.

You can assign the functions you choose to the U1–U4 buttons.

| | Type1 | Type2 | Type3 | Type4 |
|---|--------------------------------|-------------------------------|--------------------------|-------------------------------|
| A | Set List | Combination Home Page | Set List | Current Mode Home Page |
| B | Combination Select By Category | Program Home Page | Program Home Page | Current Mode Arp Page |
| C | Program Select By Category | Sequencer Home Page | Sequencer Home Page | Current Mode Sampling Page |
| D | Current Mode Arp Page | Set List | Sound Select By Category | Current Mode Tone Adjust Page |
| E | Current Mode Tone Adjust Page | Current Mode Controllers Page | Compare | Current Mode IFX Page |
| F | Current Mode Controllers Page | Sound Select By Category | Write | Current Mode MFX Page |

Setting dialog box

To assign a function, press the Edit button while U1–U4 are selected.

The A–F buttons on the screen will be outlined in pink. Touch the button for the function you want to set.



Quick Access A Setting

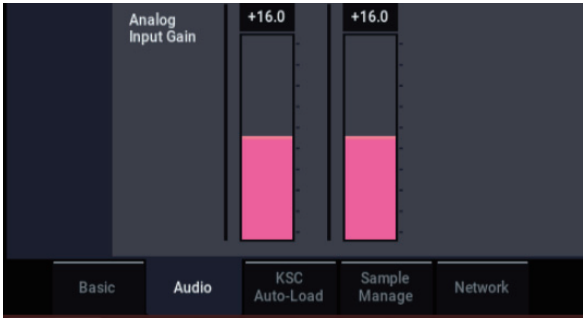

Sound Browse: Displays the Sound Browse that is set.

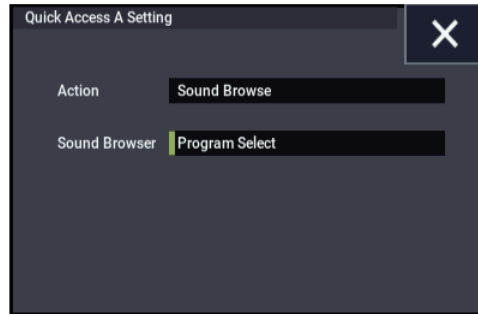

Action [None, Page Jump, Current Mode Page, Sound Browse, Function]

None: Nothing is assigned.

Page Jump: Press this button to display a page that you set. To set the page, hold down the SHIFT button and press the Quick access button while the page to which you wish to jump is shown.

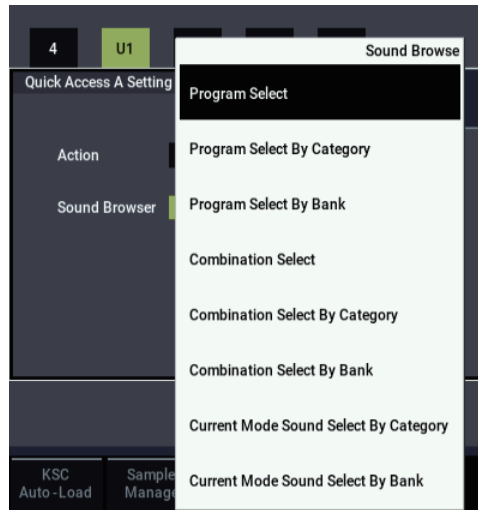
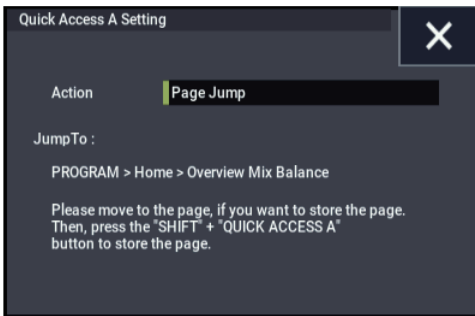

Function: Assigns the set function to the button.

Current Mode Page: Jumps to each page within the currently selected mode.

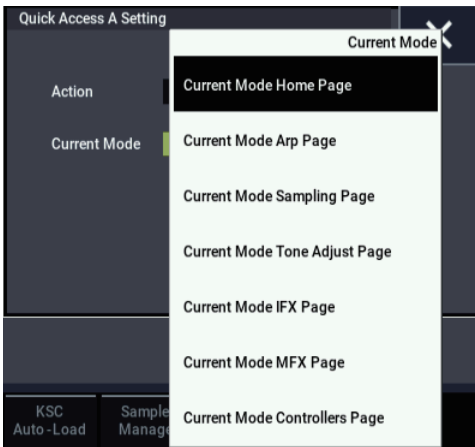
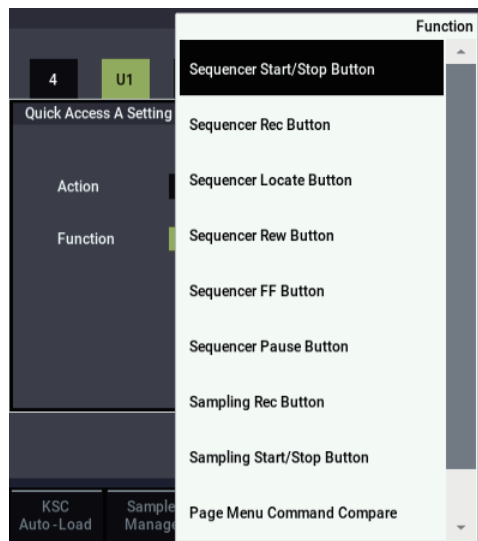
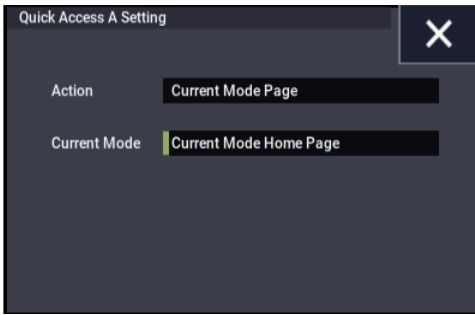
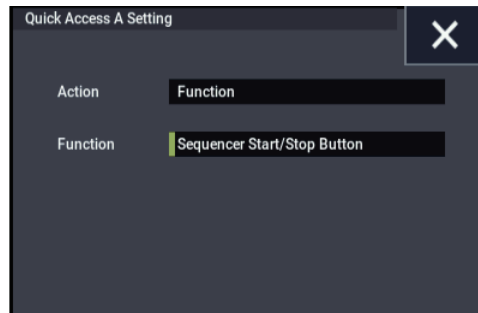

✓ 0-8: Page Menu Commands

- Write Global Setting →p.686
 - Set Program Bank Type →p.686
 - Change all bank references →p.687
 - Touch Panel Calibration →p.687
 - Half Damper Calibration →p.687
 - LCD Setup →p.688
 - Update System Software →p.688
 - Display Public ID →p.689
 - Auto Power-Off Setting... →p.689
 - Fan Control Setting →p.689
 - Rear Panel Illumination Setup →p.690
-
- PAGE →p.126
 - MODE →p.126

0–9: Manual Info

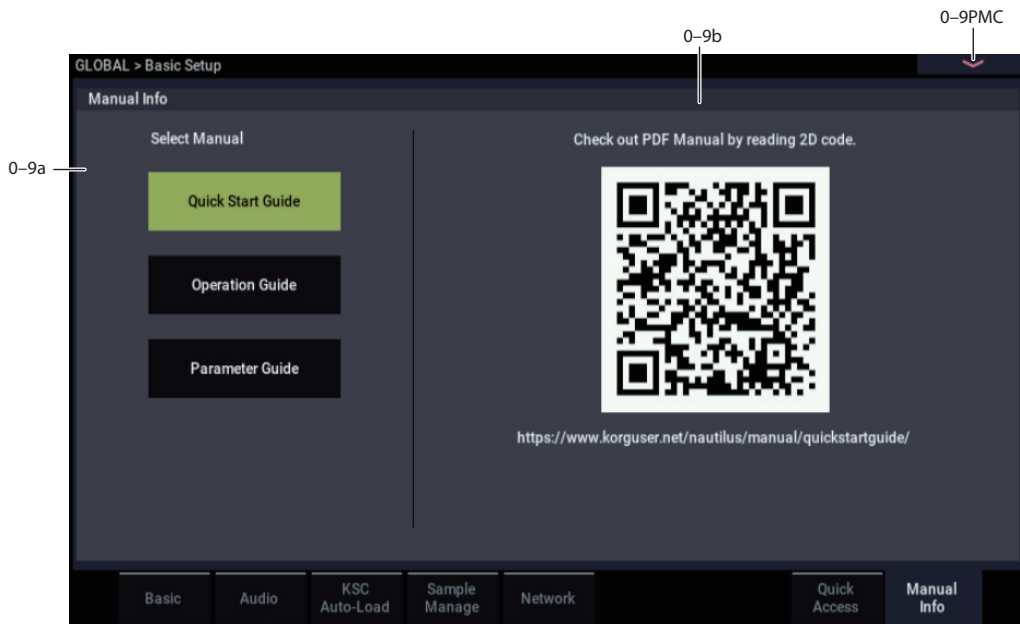

You can download and view the Owner's Manual using your tablet device or smartphone.

Note: You'll need a Wi-Fi connection to download the data.

0–9a: Manual

Select the name (type) of the manual.

0–9b: Manual URL

The link to the selected Owner's Manual will be shown as a 2D code.

Use the camera on your smartphone or other device to read the 2D code and view (download) the PDF data.

✓ 0–9: Page Menu Commands

- Write Global Setting →p.686
- Set Program Bank Type →p.686
- Change all bank references →p.687
- Touch Panel Calibration →p.687
- Half Damper Calibration →p.687
- LCD Setup →p.688
- Update System Software →p.688
- Display Public ID →p.689
- Auto Power-Off Setting... →p.689
- Fan Control Setting →p.689
- Rear Panel Illumination Setup →p.690

- PAGE →p.126
- MODE →p.126

GLOBAL > MIDI

1-1: MIDI



Here you can make MIDI-related settings that affect the entire NAUTILUS. You can also transmit MIDI System Exclusive data dumps using the page menu commands in this page.

1-1a: MIDI Setup

Basic

MIDI Channel (GLOBAL MIDI Channel) [1...16]

Sets the global MIDI channel.

The global MIDI channel is used in the following cases.

- When transmitting and receiving performance data in PROGRAM mode (PROGRAM P0: Play) and SAMPLING mode.
- When selecting combinations via MIDI in COMBINATION mode (COMBINATION P0: Play).
- When selecting Set Lists and Slots via MIDI in SET LIST mode (SET LIST P0: Play).
- When controlling timbres or effects that have been set to Gch in any mode
- When transmitting and receiving system exclusive messages

MIDI received

In PROGRAM mode (PROGRAM P0: Play), MIDI data is received on the global MIDI channel, but in COMBINATION mode (COMBINATION P0: Play) or SEQUENCER mode, MIDI data is received on the MIDI channel specified for each timbre or track.

In COMBINATION mode (COMBINATION P0: Play), program changes received on the global MIDI channel will switch the combination (1-1c: MIDI Filter).

Use the global MIDI channel to switch IFX 1-12 (CC#92), MFX1&2 (CC#94) and TFX1&2 (CC#95) on/off.

To control the pan following IFX, sends 1/2, MFX 1/2 and TFX1/2, use the global MIDI channel when in the PROGRAM or SAMPLING mode; while in the COMBINATION, or SEQUENCER modes, use the channel specified separately by **Ctrl Ch** for IFX1-12, MFX1&2, TFX1&2, and MEQ. By setting **Ctrl Ch** to Gch, you can control these parameters from the global MIDI channel.

MIDI output when playing NAUTILUS

In PROGRAM mode and SAMPLING mode, this data will be transmitted on the global MIDI channel. In COMBINATION mode, data will be transmitted simultaneously on the global MIDI channel and on the MIDI channels of timbres whose **Status** (COMBINATION 0-1b, 2-1a) is set to EXT or EX2.

In SEQUENCER mode, musical data will be transmitted on the channel specified for the currently selected track (SEQUENCER 0-1a) (whose **Status** is Both, EXT, or EX2).

Local Control On [Off, On]

Local Control On (Checked): The NAUTILUS's internal tone generator will be controlled by its own keyboard, joystick, SW1 and SW2, and connected foot pedal. If you are playing the NAUTILUS by itself, leave this setting checked.

Local Control Off (Unchecked): The NAUTILUS's keyboard and joystick etc. will be disconnected from the internal tone generator.

This means that operating the NAUTILUS (playing its keyboard and using the joystick, or playing back the sequencer) will not sound its internal tone generator.

Turn **Local Control** Off if loop-back from an external sequencer causes duplicate notes.

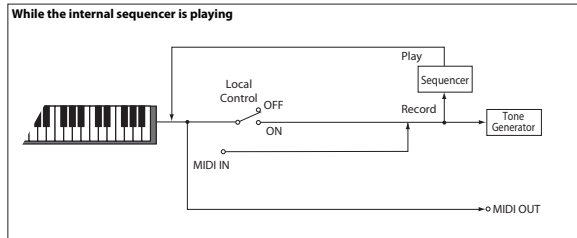
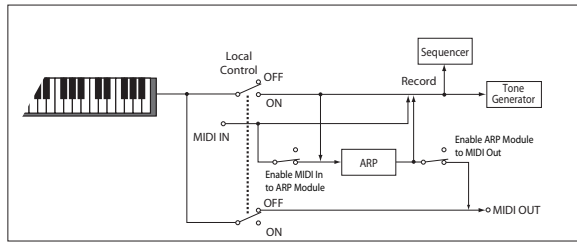

MIDI If **Local Control** is Off, MIDI transmission/ reception will occur normally. Playing the keyboard will cause the corresponding note data to be transmitted, and received note data will play the NAUTILUS's internal sounds.

Convert Position [Pre MIDI, Post MIDI]

Post MIDI also shifts Program, Combination, and Song Scales to match the **Transpose** setting—convenient for use with non-equal-tempered scales. See also “Osc/Timbre/Track Transpose” on page 632.

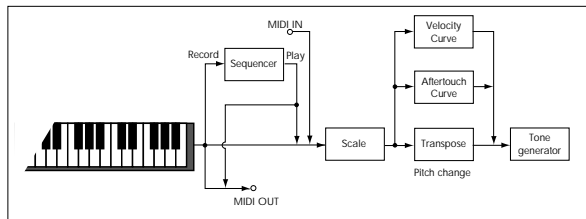

Pre MIDI is the default; it places the **Transpose** and **Velocity Curve** processors at the output of the NAUTILUS keyboard. This means that they affect both MIDI data transmitted by playing the keyboard, and data recorded from the keyboard into the internal sequencer. They do *not* affect either incoming MIDI data or data played back by the internal sequencer.

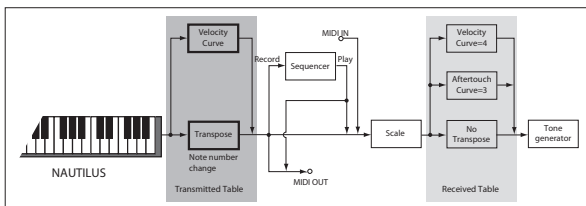

Post MIDI places the processors at the input to the NAUTILUS tone generation. This means that they affect both incoming MIDI data, and data played back by the internal sequencer. They do *not* affect either MIDI output or data recorded into the internal sequencer.

Use **Post MIDI** if you are using an external MIDI controller to play the NAUTILUS sounds, and want the NAUTILUS **Transpose**, and **Velocity Curve** settings to modify the external controller's MIDI output.

Post MIDI also shifts Program, Combination, and Song Scales to match the **Transpose** setting—convenient for use with non-equal-tempered scales. See also “Osc/Timbre/Track Transpose” on page 632.

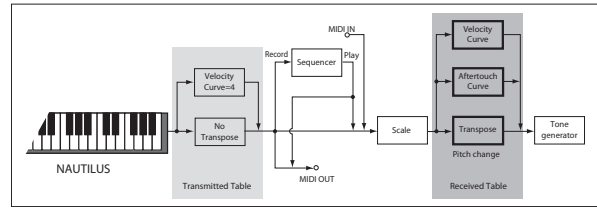

Note Receive (Note Receive Filter) [All, Even, Odd]

This setting specifies whether even-numbered, odd-numbered, or all note numbers will be sounded when note data is received from the NAUTILUS's keyboard or from an external MIDI device. By connecting the NAUTILUS to another NAUTILUS and setting one instrument to Even and the other to Odd, you can effectively double the polyphony by dividing the notes between the two instruments.

For use with Arpeggiator and the Drum, set the main keyboard to transmit ARP via MIDI, and set the slave keyboard to All ARP Off and All Drum Off.

All: All note numbers will be received. This is the default setting.

Even: Only even-numbered notes (C, D, E, F#, G#, A#) will sound.

Odd: Only odd-numbered notes (C#, D#, F, G, A, B) will sound.

MIDI This setting affects only sound generation. Other aspects of the system, such as the sequencer and MIDI through, continue to include all MIDI notes. Also, all notes from the Drum Track Pattern will play, regardless of this setting.

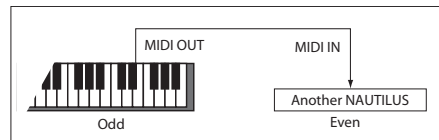

MIDI Clock

MIDI Clock (MIDI Clock Source) [Internal, External MIDI, External USB, Auto MIDI, Auto USB]

This controls whether the NAUTILUS uses the internal Tempo setting, synchronizes to incoming MIDI Clocks from external MIDI devices or USB (from a computer-based sequencer, for instance), or automatically switches between the two.

Tempo affects the internal sequencer, Arpeggiator, step sequencers, and tempo-sync'd Wave Sequences, LFOs, and delay times.

Internal: The NAUTILUS will use the internal tempo setting, as determined by the Tempo parameter, Tempo knob, and TAP button.

Select **Internal** when using the NAUTILUS by itself, or when you want the NAUTILUS to control the tempo of external MIDI devices, such as a sequencer or drum machine.

External MIDI: The NAUTILUS tempo will synchronize to incoming MIDI Clock messages.

Note: This setting relies on MIDI Clocks being received from an external device, such as a sequencer or drum machine. If MIDI Clocks are not being received, tempo-related features will not function: ARP will not play, Wave Sequences will not move from step to step, etc.

External USB: The NAUTILUS tempo will synchronize to incoming MIDI Clock messages from the USB B port. Use this when connected to a computer via USB. As with **External MIDI**, if clocks are not being received, tempo-related features will not function.

Auto MIDI: This combines the functionality of **Internal** and **External MIDI**, so that you don't have to manually switch between the two:

- If MIDI Clocks are being received, they control the NAUTILUS tempo.
- If MIDI Clocks are not being received, the NAUTILUS uses its internal tempo instead.

Auto defaults to using the internal tempo, and then automatically switches to external if MIDI Clock messages are received. It will then switch back to internal tempo in the following circumstances:

- If after receiving a MIDI Clock, Start, or Continue message, no new MIDI Clock message is received within 500 ms.
- If you start the NAUTILUS's sequencer from the front panel without having received a MIDI Clock, Start, or Continue message.

Auto USB: This combines the functionality of **Internal** and **External USB**, so that you don't have to manually switch between the two. The other details are identical to **Auto MIDI**, above.

Receive Ext. Realtime Commands [Off, On]

Off (unchecked): The NAUTILUS will not respond to most MIDI Common and Realtime messages, including Song Position Pointer, Start, Continue, and Stop. Song Select messages will still be recognized, however.

Note: Use this setting if the above messages from an external MIDI sequencer are unnecessarily resetting the NAUTILUS's Song parameters.

On (checked): The above Common messages (including Song Select) and Realtime messages will be received.

MIDI This parameter cannot be set if **MIDI Clock** is set to **Internal**.

1-1b: MIDI Routing Setup

X-Y MIDI Out [X-Y Control, X-Y CC Control]

This setting specifies the MIDI output generated by X-Y envelope.

X-Y CC Control: The NAUTILUS will transmit the MIDI control change messages specified by the X-Y CC Control "+X," "-X," "+Y," and "-Y" settings in each Program, Combination, or Song. Use this setting if you want X-Y Control operations or the X-Y envelope to transmit MIDI control change messages.

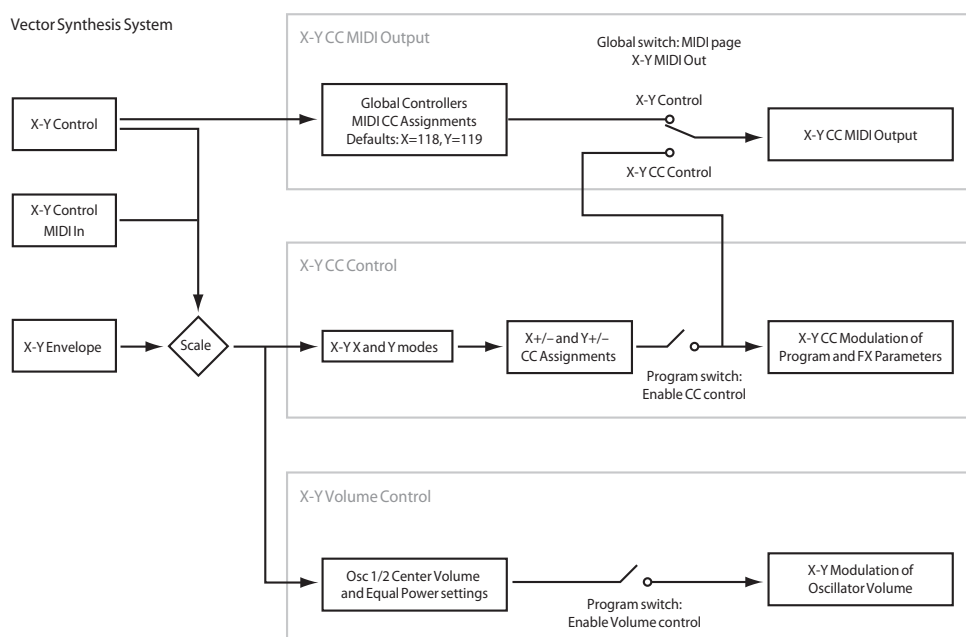

Normally you will use this to control the internal tone generator or effects, but you can also use it to transmit messages to an external MIDI device, or to record these movements on the internal sequencer or an external sequencer.

ARP External Routing

These parameters control MIDI input to and output from ARP.

Enable ARP Module to MIDI Out [Off, On]

This controls whether or not ARP-generated events will be transmitted to external devices.

On (checked): MIDI events generated by ARP Module will be transmitted to external devices.

Off (unchecked): MIDI events generated by ARP will play the internal NAUTILUS sounds, but MIDI messages will not be transmitted to external devices.

Enable MIDI In to ARP Module [Off, On]

This controls whether or not incoming MIDI messages will be received by ARP.

On (checked): MIDI messages will be received by ARP, and will control ARP just like the NAUTILUS’s built-in keyboard.

Off (unchecked): Only the built-in keyboard will control ARP; MIDI messages will affect the rest of the NAUTILUS as normal, but ARP will ignore them.

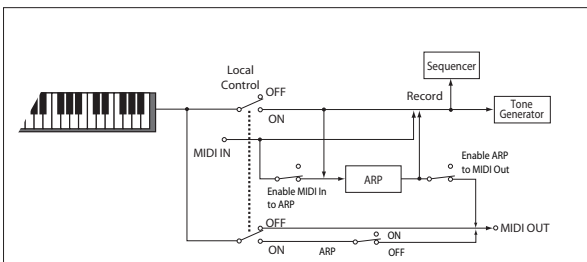

Example settings

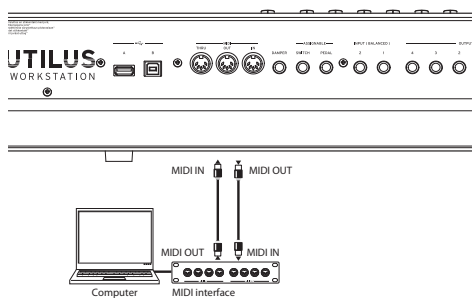

You can use ARP to control external MIDI devices, and record ARP-generated phrases into an external sequencer.

Enable ARP Module to MIDI Out = On

Enable MIDI In to ARP Module = Off

Local Control On = On

You can also use MIDI input to trigger ARP. Or, use an external sequencer to record only the notes you physically play on the NAUTILUS keyboard, and then play them back to trigger ARP in real-time.

Enable ARP Module to MIDI Out = Off

Enable MIDI In to ARP Module = On

Local Control On = Off

Start/Stop (Realtime) Out

Enable Start/Stop Out in Prog/Combi [Off, On]

In PROGRAM and COMBINATION modes, this function transmits a MIDI start message when you trigger Arpeggiator, and a MIDI stop message when you turn it off. This lets you make an external MIDI sequencer or rhythm/groove machine start playing at the moment that Arpeggiator begins playing.

Off (unchecked): Normally you will leave this Off.

On (checked): MIDI system realtime messages “Start” and “Stop” will be transmitted in PROGRAM and COMBINATION mode. If **MIDI Clock** (1–1a) is set to Internal or Auto (and operating as Internal), the start and stop messages will be transmitted under the conditions described below. This can be used to simultaneously start an external MIDI sequencer or rhythm/groove machine at the moment Arpeggiator begins playing.

Start: If the ARP button is on, the MIDI system realtime message “Start” will be transmitted at the moment you use the keyboard to trigger the pattern.

Note: “Start” will be transmitted at the moment that the ARP module pattern is triggered, according to the module’s “ARP Key Zone” setting (PROGRAM 7–1a, COMBINATION 7–1b).

Stop: If “Start” has been previously transmitted, the MIDI system realtime message “Stop” will be transmitted at the moment you turn off the ARP button.

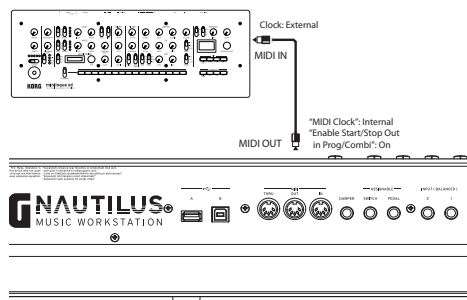

For more information, see “Connecting MIDI devices & computers” on page 929, “Synchronizing the playback of arpeggiator or sequencer” on page 938, and “Synchronizing the Drum Track” on page 167 of the OG.

1-1c: MIDI Filter

Enable Program Change [Off, On]

On (checked): Program changes will be transmitted and received.

In PROGRAM mode (PROGRAM P0: Play), the program will be switched when a program change message is received on the global MIDI channel specified by **MIDI Channel** (1-1a). When you switch programs, a program change message will be transmitted on the global MIDI channel.

In COMBINATION mode (COMBINATION P0: Play), the combination will be switched when a program change message is received on the global MIDI channel. However, it is possible to set the “Enable Combination Change” parameter so that the combination is not switched. When a program change is received on the channel specified for each timbre by **MIDI Channel** (COMBINATION 2-1a), the program of that timbre will be switched. However, the program changes for each timbre will be affected by the setting of the “Enable Program Change” parameter (COMBINATION 3-1a).

When you switch combinations, a program change message will be transmitted on the global MIDI channel, and also transmitted simultaneously on the channel of timbres whose **Status** (COMBINATION 0-1b, 2-1a) is set to EXT or EX2.

In SEQUENCER mode, incoming program change messages on a channel that corresponds to a track whose **Status** (SEQUENCER 2-1a) is set to INT or Both will switch programs on that track. When you select a song or playback sequencer data, program changes will be transmitted on the channels of tracks whose **Status** is set to Both, EXT, or EX2.

In SET LIST mode (Home), the slot will be switched when a program change message is received on the global MIDI channel. When you switch slots, a program change message will be transmitted on the global MIDI channel. If the Slot contains a Combination or Song, other program change messages may be transmitted on additional MIDI channels, as would normally occur in COMBINATION or SEQUENCER modes.

Off (unchecked): Program changes will not be transmitted or received.

Bank Change [Off, On]

On (checked): The Bank Select control change message will be transmitted together with program change messages. This is valid when “Enable Program Change” is checked.

Off (unchecked): Bank Select messages will not be transmitted or received.

When recording on the internal sequencer, bank select messages will be recorded regardless of this setting. However for playback, this setting will apply.

This also controls send and receive of Bank Select messages for Set List selection in SET LIST mode.

Combination Change [Off, On]

On (checked): When in COMBINATION P0: Play, an incoming program change message on the global MIDI channel set by **MIDI Channel** (1-1a) will switch Combinations.

This is valid when “Enable Program Change” is checked.

An incoming program change on a channel other than the global MIDI channel will switch the program of any timbre that matches that MIDI channel.

Off (unchecked): An incoming program change message on the global MIDI channel will switch the program of any timbre whose **MIDI Channel** (COMBINATION 2-1a) matches the global MIDI channel. The combination will not be switched.

The program changes for each timbre will be affected by the setting of the “Enable Program Change” parameter (COMBINATION 3-1a).

Enable After Touch [Off, On]

On (checked): MIDI aftertouch messages will be received.

Off (unchecked): MIDI aftertouch messages will not be received.

Enable Control Change [Off, On]

On (checked): Control change messages will be transmitted and received.

Off (unchecked): Control change messages will neither be transmitted nor received.

This setting has no effect when you use the internal sequencer to playback sequence data that was recorded with control change data; i.e., the control changes previously recorded into the sequencer will be transmitted via MIDI.

Enable Exclusive [Off, On]

On (checked): System exclusive data will be transmitted and received.

Check this if you want to edit the NAUTILUS from a connected computer, or if you want to allow bi-directional editing.

Off (unchecked): System exclusive data will not be transmitted. Normally you will leave this unchecked.

Note: The “Dump” menu commands (“Dump Program”–“Dump Arpeggio Pattern”) will continue to function regardless of this setting.

1-1d: SEQ MIDI Out Setup

Song Track [for Master, for External Seq]

This setting specifies what will be transmitted via MIDI when you switch songs in SEQUENCER mode.

for Master: When you switch songs in SEQUENCER mode, tracks whose Status is EXT or Both will transmit MIDI messages* such as program changes to set-up an external MIDI sound module.

for External Seq: Choose this option if you’re using SEQUENCER mode as an external multi-timbral sound module. When you switch songs on the NAUTILUS, no track whose Status is set to EXT or Both (i.e., any setting other than INT) will transmit MIDI messages* such as program changes. This prevents echo-back from the tracks of your external MIDI sequencer from overwriting the program and other parameters of tracks that are set to the same MIDI channel.

* Applicable MIDI messages and corresponding parameters:

- Program Select: CC#00 bank select (LSB), CC#32 bank select (MSB), program change

- Volume: CC#7 volume
- Pan: CC#10 pan
- Portamento: CC#65 portamento On/Off, CC#5 portamento time
- Send 1/2: CC#93 send 1 level, CC#91 send 2 level
- (Post FX) Pan: CC#8 post insert effect pan

Param Edit **[Control Change, SysEx Param Change]**

This setting specifies whether control changes or system exclusive messages will be transmitted when you edit a parameter in SEQUENCER mode.

Control Change: Data for the edited parameter will be transmitted as a control change.

SysEx Param Change: Data for the edited parameter will be transmitted as a parameter change.

Note: For these to operate, **Enable Control Change** or **Enable Exclusive** must be checked respectively. See “Enable Control Change” and “Enable Exclusive,” above.

* Applicable MIDI messages and corresponding parameters:

- Volume: CC#7 volume
- Pan: CC#10 pan
- Send 1/2: CC#93 send 1 level, CC#91 send 2 level

1-1e: Drum MIDI Setup

In PROGRAM mode, if the **Trigger Mode** is set to Wait KBD Trig, the Drum Track starts and stops in response to the global MIDI channel. However, you can also play the drums Program directly via MIDI on a separate channel, and optionally transmit the drum Pattern/step sequence to MIDI out.

Note: Drums Programs do not transmit or receive MIDI program changes.

Prog MIDI Ch **[01...16]**

This sets the MIDI channel for drum track transmission and reception in PROGRAM mode. This means that you can play the drums Program separately from the main Program via MIDI, if desired.

If **Prog MIDI Out** is On (checked), drum pattern/step sequence note data will be transmitted on this MIDI channel. The default setting is channel 10.

Prog MIDI Out **[Off, On]**

On (checked): The note data of the drum track pattern/step sequence will be transmitted on the channel specified by Prog MIDI Ch.

Off (unchecked): The note data of the drum track pattern/step sequence will not be transmitted.

✓ **1-1: Page Menu Commands**

- Write Global Setting →p.686
- Dump Program →p.690
- Dump Combination →p.690
- Dump Drum Kit →p.690
- Dump Wave Sequence →p.690
- Dump Global Setting →p.690
- Dump Sequencer →p.690
- Dump Set List →p.690
- Dump Drum Track Pattern →p.690
- Dump Arpeggio Pattern →p.690
- PAGE →p.126
- MODE →p.126

GLOBAL > Wave Sequence

Wave Sequences play back a series of different Multisamples over time. You can use this to create a variety of unique timbral and rhythmic effects, as described below.

Like Drum Kits, Wave Sequences are edited in GLOBAL mode, and then used PROGRAM > Basic/X-Y/Controllers–Program Basic page. For more information on using Wave Sequences in Programs, see “2-1c: OSC1 Multisample/Wave Sequence” on page 51.

When editing Wave Sequences, you’ll hear them as if they were being played through the parameter settings of the previously selected Program or Combination. This includes filter settings, envelopes, etc. So, before you begin, it’s best to first select a suitable sound in PROGRAM mode, and then enter GLOBAL mode.

For detailed step-by-step instructions on creating and editing Wave Sequences, please see “Using Wave Sequences” on page 183 of the OG.

Rhythmic Wave Sequences

Rhythmic Wave Sequences use short or abrupt crossfades, so that transitions between the different Multisamples create a rhythmic phrase. Flexible swing amount, rests, and ties let you build complex patterns, which you can then sync to ARP and the system tempo.

Crossfading Wave Sequences

By using long durations and crossfade times, Wave Sequences can produce complex, evolving timbres. Modulating the Start Step, Position, and Duration makes the sound even more organic, so that every note can play the Wave Sequence a little differently.

Velocity-Switching Wave Sequences

By setting each step’s duration to GATE, and then modulating the Start Step by velocity, you can create a sound with up to 64 velocity switches. For instance, you can use this to switch between a large number of different attack transients.

2-1: Seq. Parameter

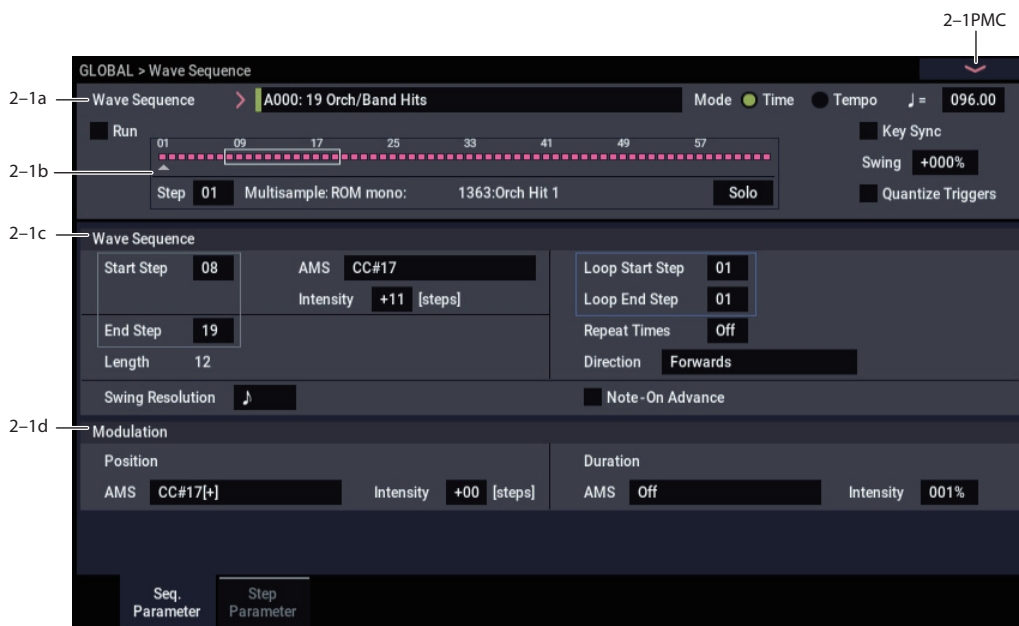

This page contains parameters for the selected Wave Sequence as a whole.

2-1a: Basic

Wave Sequence [A000...A149, B00...O31]

The Wave Sequences in the banks A...I are the built-in “factory” sounds. You can over-write them if you wish, but doing so may change the sounds of the factory Programs in banks A...I, and the Combinations in banks A, B.

As shipped from the factory, all banks except A...I are empty. You can use these for storing sounds that you create yourself, optional sound banks from Korg, or third-party sound libraries. Each User bank has space for 32 Wave Sequences.

When the Wave Sequence Select window is open, you can use the Find button to search for Wave Sequences by name. For more information, see “Find dialog” on page 7.

Mode [Time, Tempo]

This switches between **Time** mode (for crossfading Wave Sequences) and **Tempo** mode (for rhythmic Wave Sequences).

In **Time** mode, step durations are specified in milliseconds, and are not affected by the system tempo.

In **Tempo** mode, step durations are specified in rhythmic values, and are synchronized to the system tempo.

Each step stores separate values for the two modes, so that you can switch back and forth without losing any data.

Crossfade times are always specified in milliseconds, regardless of the **Mode** setting.

J = (Tempo) [040.00...300.00 BPM]

This is the current system tempo.

If the GLOBAL mode **MIDI Clock** parameter is set to **Internal**, you can adjust the tempo directly from this parameter, as well as using the TAP button.

If **MIDI Clock** is set to **External**, this will simply display “EXT.”

 The **Tempo** parameter on this page affects the way that the Wave Sequence plays back during editing, but is not stored with the Wave Sequence itself. Instead, each Program, Combi, and Song has its own stored tempo.

Run [Off, On]

When this is **On**, the Wave Sequence will move through its steps automatically, according to the Duration and Crossfade settings for each step.

When this is **Off**, the Wave Sequence will not move from step to step automatically, and the steps’ Duration and Crossfade settings will be ignored. You can then:

- Use Position Modulation to sweep through the steps manually
- Use Note-On Advance to increment the step with each new note
- Use Start Step AMS to play a different step with each note, modulated by velocity or other AMS sources

Key Sync [On, Off]

On (checked): When Key Sync is On, each note’s Wave Sequence(s) will progress independently, so that each one can be on a different step, or moving at a different rate.

Off (unchecked): When Key Sync is Off, all of the Wave Sequences will be synchronized on the same step. There is one exception to this, however: if Duration is modulated with velocity or note-number, the Wave Sequences can still progress at different rates.

 The **Key Sync** parameter on this page affects the way that the Wave Sequence plays back during editing, but is not stored with the Wave Sequence itself. Instead, each Program, each Combi Timbre, and each Track in a Song has its own **Key Sync** setting.

Swing [-300%...+000...+300%]

This parameter applies only when the **Mode** is set to **Tempo**.

Use **Swing** to add a sense of swing to the rhythm. For example, Swing provides an easy way to turn a “square” rhythm into a shuffle groove.

Swing adjusts the position of the up-beats, relative to the Wave Sequence’s Resolution setting. For instance, if the Resolution is set to 1/8, Swing affects every other 8th note.

When Swing is set to **+100%**, these notes will be moved one third of the way toward the next down-beat. If the Resolution is 1/8, for example, +100% changes straight 8th notes into 8th note triplets.

When Swing is set to **+300%**, up-beats will be moved all the way to the next down-beat. At this point, the notes on the up-beats will not be heard at all.

Positive values make the up-beats later, and negative values make them earlier.

 The **Swing** parameter on this page affects the way that the Wave Sequence plays back during editing, but is not stored with the Wave Sequence itself. Instead, each Program, each Combi Timbre, and each Track in a Song has its own **Swing** setting.

Wave Sequence Swing

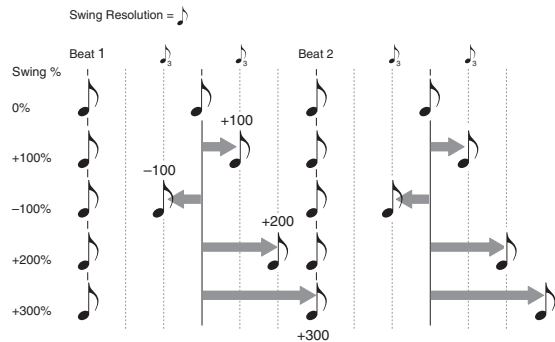

Quantize Triggers [Off, On]

This parameter applies only when the **Mode** is set to **Tempo**.

It allows you to force most Tempo-mode Wave Sequence note-ons to be in sync, making it easier to play along with other rhythmic elements.

When **Quantize Triggers** is **On**, note-ons are quantized to 8th notes using the current tempo reference. (See below for a few more details.)

The tempo reference can come from different sources, depending on the current mode, and whether or not ARP is on:

- In PROGRAM and COMBINATION modes, if ARP is off, note-ons are synchronized with the sounding Tempo-mode Wave Sequence, if any.
- In PROGRAM and COMBINATION modes, if ARP is on, note-ons are synchronized with ARP.
- In SEQUENCER mode during playback or recording, note-ons are synchronized with the sequence.
- In SEQUENCER mode, while the sequencer is stopped, note-ons are synchronized with RPPR and ARP.

On (checked): Note-ons will be quantized.

Off (unchecked): Note-ons will be played instantly, the moment that you play the keyboard.

 The **Quantize Triggers** parameter on this page affects the way that the Wave Sequence plays back during editing, but is not stored with the Wave Sequence itself. Instead, each Program, each Combi Timbre, and each Track in a Song has its own **Quantize Triggers** setting.

How Quantize Triggers works

The **Quantize Triggers** feature tries to make a good guess at where you intended the note to be. If you play the note just a bit late—within a 32nd note of the 8th note—it will assume that you meant the note to sound on the beat that just passed. In this case, the note will play immediately.

On the other hand, if you play the note up to three 32nd notes early, it will assume that you’re intending the note to sound on the next beat. In this case, the note-on is delayed until the next 8th note.

Quantize Triggers

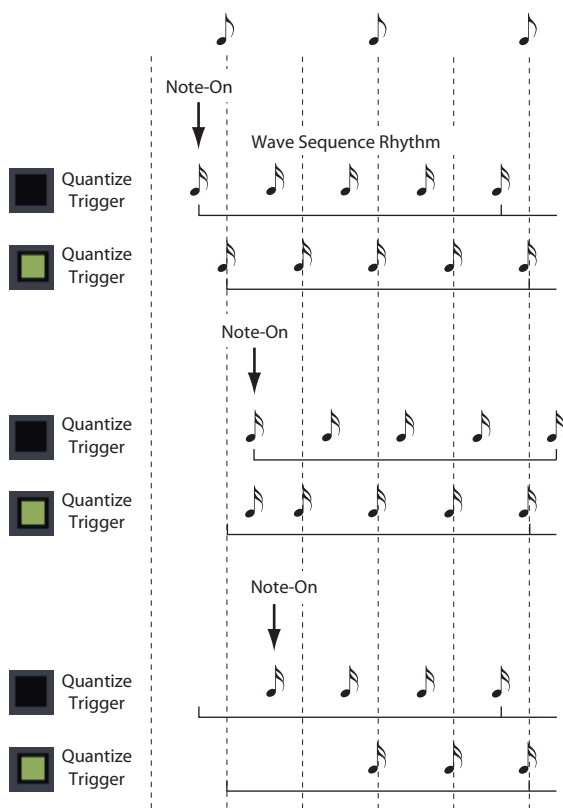

Note: When **Note-On Advance** is **On**, **Start Step** modulation is disabled. For more information, see “Note-On Advance” on page 660.

AMS [List of AMS Sources]

This selects a modulation source to control the Start Step. For a list of AMS sources, see “Alternate Modulation Source (AMS) List” on page 903.

Intensity [-63...+63]

This controls the depth and direction of the Start Step modulation. Negative modulation moves the Start Step earlier in the sequence, to the limit of Step 1. Positive modulation moves the Start Step later in the sequence, to the limit of the End Step.

End Step [1...64]

This sets the number of steps in the Wave Sequence.

Length (Read Only) [1...64]

This read-only display shows the total number of steps in the Wave Sequence, based on the **Start Step** and **End Step**.

Swing Resolution [♩³...]

This sets the resolution which will be used for swing. If a Program contains multiple Wave Sequences with different **Swing Resolution** settings, the Program will use the finest value. For instance, if one Wave Sequence is set to 1/8 and the other is set to 1/16, the Program will use 1/16.

While the resolution is stored in the Wave Sequence, the swing amount is set in the Program, Combi Timbre, or Song Track. This lets you use a single Wave Sequence in different Programs, Combis, and Songs, each with different amounts of swing.

2-1b: Graphic

The graphic gives you a visual overview of the Wave Sequence:

- The current step is marked by a red arrow.
- Red boxes are Multisample steps.
- Green boxes are Tie steps.
- White boxes are Rest steps.
- The length of the Wave Sequence, from the Start Step to the End Step, is shown by a rectangular outline.
- The Loop is highlighted in blue.

Step [1...64]

This selects the current step. This is convenient when setting the Start, End, Loop Start, or Loop End steps.

Multisample (Read-Only) [Bank, Number, and Name]

This shows the bank, number, and name of the current step’s Multisample.

Solo [Off, On]

This button solos the current step, so that you can hear it quickly and easily. When **Solo** is **On**, the Wave Sequence will play only the current step, including the fade-in and fade-out.

2-1c: Wave Sequence

Start Step [1...64]

This is the step on which the Wave Sequence starts. You can modulate this via AMS.

Loop Parameters

Wave Sequences can loop, so that some or all of the steps are played repeatedly—like a drum loop, or a loop in a sequencer.

You can set the start and end of the loop separately from the start and end of the Wave Sequence itself. The loop can either play for as long as the note is played, or repeat a specified number of times. Finally, you can choose whether the loop plays forwards, plays backwards, or alternates between backwards and forwards.

Loop Start Step [1...64]

This is the step on which the loop starts.

Loop End Step [1...64]

This is the step on which the loop ends. It must be after the Loop Start.

Direction [Forwards, Backwards/Forwards, Backwards]

This sets the direction in which the loop is played.

Forwards plays from the Start Step to the Loop End, and then skips back to the Loop Start.

Backwards/Forwards plays from the Start Step to the Loop End, then backwards from the Loop End to the Loop Start, and then forwards again to the Loop End, and so on.

Backwards plays from the Start Step to the Loop End, then backwards from the Loop End to the Loop Start, and then skips back to the Loop End, and so on.

For instance, let's say that **Repeat Times** is set to **1**, **Loop Start** is set to **2**, and **Loop End** is set to **4**. In this case, the different **Loop Directions** work as shown below. The loop itself is shown in **bold italic type**.

Forwards: 1, 2, 3, 4, **2, 3, 4**, 5, 6.

Backwards: 1, 2, 3, **4, 3, 2**, 5, 6.

Backwards/Forwards: 1, 2, 3, 4, **3, 2, 3, 4**, 5, 6.

Repeat Times [Off, 1...127, INF]

This sets how many times the loop is repeated.

OFF means that the **Loop Start**, **Loop End**, and **Loop Direction** parameters have no effect. The Wave Sequence will play from the **Start Step** to the **End Step**, and then stay at the **End Step** for the remainder of the note.

When this is set between **1** and **127**, the loop will repeat the specified number of times. Once the repeats have finished, it will play through to the **End Step**, and then stay there for the remainder of the note.

INF means that the loop will repeat continuously for the duration of the note.

Note-On Advance [Off, On]

This parameter lets you advance the start point of the Wave Sequence by one step with each new note-on. If **Repeat Times** is not set to **Off**, this will step through the loop, paying attention to the loop direction and number of repeats.

For instance, let's say that the Wave Sequence **Start Step** is **2**, and the **End Step** is **6**. Also, the **Loop Start** is set to **3**, the **Loop End** is set to **5**, and the **Loop Direction** is set to **Forward**.

If **Repeat Times** is **Off**, **Note-On Advance** will make the Wave Sequence play as follows:

- 1st note: 2, 3, 4, 5, 6
- 2nd note: 3, 4, 5, 6
- 3rd note: 4, 5, 6
- 4th note: 5, 6
- 5th note: 6
- 6th note: 2, 3, 4, 5, 6
- 7th note: 3, 4, 5, 6
- 8th note: 4, 5, 6
- 9th note: 5, 6
- 10th note: 6
- 11th note: 2, 3, 4, 5, 6
- etc...

If **Repeat Times** is **1**, **Note-On Advance** will make the Wave Sequence play as follows:

- first note: 2, 3, 4, 5, 3, 4, 5, 6
- 2nd note: 3, 4, 5, 3, 4, 5, 6
- 3rd note: 4, 5, 3, 4, 5, 6
- 4th note: 5, 3, 4, 5, 6
- 5th note: 3, 4, 5, 6
- 6th note: 4, 5, 6
- 7th note: 5, 6
- 8th note: 6
- 9th note: 2, 3, 4, 5, 3, 4, 5, 6

10th note: 3, 4, 5, 3, 4, 5, 6

11th note: 4, 5, 3, 4, 5, 6

12th note: 5, 3, 4, 5, 6

13th note: 3, 4, 5, 6

14th note: 4, 5, 6

15th note: 5, 6

etc...

Finally, if **Repeat Times** is **1**, **Note-On Advance** will make the Wave Sequence play as follows. Note that the Wave Sequence never returns to the start step, since it's outside of the loop:

- first note: 2, 3, 4, 5, 3, 4, 5, 3, 4, 5, 3, 4, 5...
- 2nd note: 3, 4, 5, 3, 4, 5, 3, 4, 5, 3, 4, 5...
- 3rd note: 4, 5, 3, 4, 5, 3, 4, 5, 3, 4, 5...
- 4th note: 5, 3, 4, 5, 3, 4, 5, 3, 4, 5...
- 5th note: 3, 4, 5, 3, 4, 5, 3, 4, 5...
- 6th note: 4, 5, 3, 4, 5, 3, 4, 5...
- 7th note: 5, 3, 4, 5, 3, 4, 5...
- 8th note: 3, 4, 5, 3, 4, 5...
- 9th note: 4, 5, 3, 4, 5, 3, 4, 5...
- 10th note: 5, 3, 4, 5, 3, 4, 5...
- etc...

2-1d: Modulation

Position

AMS [List of AMS Sources]

This selects a modulation source to offset the Wave Sequence from its current position. The Wave Sequence will continue to progress through its steps during position modulation. To sweep through a sequence manually, set "Run," above, to **Off**.

If Position AMS changes by a large value over a small amount of time, it will skip intermediate steps if necessary.

For a list of AMS sources, see "Alternate Modulation Source (AMS) List" on page 903.

Intensity [-63...+63]

This controls the depth and direction of the Position modulation. Negative modulation moves the position earlier in the sequence, to the limit of Step 1. Positive modulation moves the position later in the sequence, to the limit of the End Step.

Position modulation and loops

Position AMS affects only the current step, and does not change the loop start or loop end. This means that Position AMS can make the Wave Sequence jump into the middle of the loop, or jump back out of the loop again.

Duration

AMS [List of AMS Sources]

This selects a modulation source to control the step duration and crossfade times. You can speed up or slow down the Wave Sequence so that it runs between 1% and 400% of the original rate. This can be very useful for making a cross-faded Wave Sequence sound more organic.

For a list of AMS sources, see “Alternate Modulation Source (AMS) List” on page 903.

Intensity [1...400%]

This controls the amount of Duration modulation.

1% means that, at the maximum AMS value, step durations and crossfade times will be 100 times shorter than their programmed settings.

400% means that, at the maximum AMS value, step durations and crossfade times will be four times longer than their programmed settings.

Put another way, values **99%** and lower make the Wave Sequence go faster, and values **101%** and higher make it go slower.

✓ **2-1: Page Menu Commands**

- Compare →p.112
- Write Wave Sequence →p.692
- PAGE →p.126
- MODE →p.126

2-2: Step Parameter



2-2a: Basic

Wave Sequence [A000...A149, B00...O31]

This is the bank, number, and name of the current Wave Sequence. For more information, please see “Wave Sequence,” on page 657.

Mode [Time, Tempo]

This switches between **Time** mode (for evolving, crossfaded Wave Sequences) and **Tempo** mode (for rhythmic Wave Sequences). For more information, please see “Mode,” on page 657.

♩= (Tempo) [040.00...300.00, EXT]

This is the current system tempo. For more information, please see “Tempo” on page 658.

Run [Off, On]

This determines whether or not the Wave Sequence will move through its steps automatically. For more information, please see “Run,” on page 658.

Key Sync [Off, On]

This determines whether each note will play its Wave Sequence separately (**Key Sync On**), or whether all of the notes will play together (**Key Sync Off**). For more information, please see “Key Sync,” on page 658.

Swing [-300%...+000...+300%]

Swing adjusts the position of the up-beats, relative to the Wave Sequence’s Resolution setting. This parameter applies only when the **Mode** is set to **Tempo**.

For more information, please see “Swing,” on page 658.

Quantize Triggers [Off, On]

This parameter allows you to force most Tempo-mode Wave Sequence note-ons to be in sync, making it easier to play along with other rhythmic elements. It applies only when the **Mode** is set to **Tempo**. For more information, please see “Quantize Triggers,” on page 658.

2-2b: Graphic

The graphic gives you a visual overview of the Wave Sequence. There's one addition from the graphic shown on the other page: a scroll-bar over the top of the graphic shows the 8 currently displayed steps.

For more information, please see "2-1b: Graphic," on page 659.

Step [1...64]

This selects the current step, which applies to the Cut, Copy, Paste, and Insert commands.

Multisample (Read-Only) [Bank, Number, and Name]

This shows the bank, number, and name of the current step's Multisample.

Solo [Off, On]

This button solos the current step, so that you can hear it quickly and easily. When **Solo** is **On**, the Wave Sequence will play only the current step, as if **Run** were **Off**.

2-2c: Step parameters

This list shows the parameters for eight steps at a time. Use the scroll bar at the right of the screen to change which steps are in view.

Type [Multisample, Rest, Tie]

This sets the step to one of three basic types.

Multisample means that the step will sound a new Multisample, as set by the **Multisample Select** parameter, below.

Rest means that the step will be silent.

Tie is an alternate way of creating rhythmic values, which may sometimes be more convenient than using the Base Note and x (Multiply Base Note By) parameters. Steps set to **Tie** simply extend the duration of the previous step; all parameters other than **Duration**, **Crossfade**, and **Fade-Out Shape** will be grayed out.

Additionally, the **Crossfade** and **Fade-Out Shape** settings of the previous step have no effect.

Multisample Select [List]

This menu selects the step's Multisample.

 Some Multisamples may have an upper limit to their keyboard range, above which they may not produce any sound.

When the Multisample Select window is open, you can use the Find button to search for Multisamples by name. For more information, see "Find dialog" on page 7.

Bank (Multisample) [List of Multisample Banks]

There are four types of Multisample Banks: **ROM**, **SAMPLING mode**, **EXs**, and **User Sample Banks**.

ROM Multisamples are the built-in "factory" sounds, and are always available.

Smp (SAMPLING Mode) Multisamples are the ones that you can see and edit in SAMPLING mode. After the abbreviation "Smp," several different things may appear, as described below.

Smp: Old RAM means that this is an older Program pointing to the legacy "RAM" bank. Instead of pointing to a specific User Sample Bank, it will use whatever Multisample data is loaded into SAMPLING mode.

Smp: New Sampling Session will appear when there's data in SAMPLING mode which hasn't yet been saved to drive as a User Sample Bank. For instance, this might happen if you've loaded an old KSC file, loaded individual Samples or Multisamples, or recorded some new samples. Once the KSC is saved to drive, the name will update to show the file path (as described below).

Smp: [file name] will appear when a User Sample Bank has been loaded into SAMPLING mode. The name is the file name itself along with those of all its enclosing folders.

EXs Multisample banks are PCM expansion sets created especially for the NAUTILUS. Each has its own unique number; for instance, the EXs301 German2 D Piano mono. Only the currently loaded EXs banks will appear on this menu.

User Sample Banks bring the benefits of EXs to your own sample libraries. You can load and play gigabytes of your custom or converted samples at once, using Virtual Memory. The name is shown as a path to the KSC file, including the file name and the names of all enclosing directories. Only the currently loaded User Sample Banks will appear in this menu.

If a sound refers to a User Sample Bank which is not on the internal drive(s), the name will appear as "Unknown Sample Bank [number]" when the bank select dialog is open, shortened to "??[number]" when the dialog is closed.

For more information, see "User Sample Banks" on page 151 of the OG.

Start Offset [Off, 1st...8th]

In addition to simply starting playback from the beginning, ROM and EXs Multisamples can have up to 8 different pre-programmed alternate starting points, called Start Offsets.

Similarly, SAMPLING mode and User Sample Bank Multisamples can play either from the beginning of the waveform, or from the loop start point.

Start Offsets: ROM and EXs

With ROM and EXs Multisamples, the Start Offset specifies whether to use the normal start point (**Off**), or to use one of the alternate start points (**1st-8th**).

Some ROM and EXs Multisamples may have fewer than 8 pre-programmed points, in which case only the available points can be selected.

Start Offsets: SAMPLING mode and User Sample Banks

With SAMPLING mode and User Sample Bank Multisamples, only **Off** and **1st** are available. **Off** uses the normal start point, and **1st** uses the loop start instead. **2nd** through **8th** will be grayed out.

Rev. (Reverse) [Off, On]

This lets you play the selected Multisample backwards, without looping.

Note: If the individual samples within the Multisample are already set to Reverse, they will still play in reverse, regardless of this setting.

On (checked): The Multisample will play back in reverse.

Off (unchecked): The Multisample will play back normally.

Trans. (Transpose) [+/- 24 semitones]

This controls the step's coarse tuning, in semitones.

Tune [+/- 1200 cents]

This sets the step's fine tuning, in cents (1/100 of a semitone).

Level [0-127]

This sets the volume level for the step.

Duration: Mode = Time

The format for setting the Duration will be different depending on whether the Wave Sequence **Mode** is set to **Time** or **Tempo**.

Duration [0ms...10 sec, GATE]

This sets the duration of the step, in milliseconds or seconds. In Time mode, the duration is not affected by the system tempo.

When set to **GATE**, the sequence pauses at the step until note-off, and then the sequence continues. Multiple steps can be set to **GATE**, for modulation via Start Step AMS, Position AMS, or Note-On Advance.

Duration: Mode = Tempo

In this mode, the Wave Sequence synchronizes to the system tempo, as set by either the Tempo knob or MIDI Clock. The step durations are controlled by the **Base Note** and **Multiply** parameters, below

(Base Note) [ ...  GATE]

This sets the basic duration of the step, relative to the system tempo. The values range from a 32nd note to a whole note, including triplets.

GATE works the same as in Time mode.

x (Multiply Base Note by...) [01...32]

This multiplies the length of the Base Note. For instance, if the Base Note is set to a sixteenth note, and Times is set to 3, the step's duration will be a dotted eighth note.

Xfade [0ms...10 sec]

This determines the time it takes to fade into the *next* step. For example, Step 1's Crossfade determines the time to fade between Step 1 and Step 2.

Crossfades use millisecond units for both **Time** and **Tempo** modes.

Note: In **Time** mode, the **Xfade** time cannot exceed the total duration of the two steps being crossfaded; in **Tempo** mode, it cannot exceed twice the duration of the shorter of the two steps.

The **Fade-In** and **Fade-Out Shape** parameters, below, allow linear, equal-power, and custom crossfades.

Fade-Out Shape [Off, Log, -126...-1, Linear, +1...126, Exp]

This sets the shape for the first step's fade-out within the crossfade.

Off means that the step will continue to sound at full volume for the full duration of the crossfade, and then cut off abruptly.

Log means that the step will fade out slowly at first, and then move more rapidly as it approaches the end of the crossfade. You can create an equal-power crossfade by using this shape for both the fade-out of one step and the fade-in of the next step.

Linear means that the step will fade out steadily, at a constant rate, over the duration of the crossfade.

Exp means that the step will fade out quickly at first, and then fade out more slowly as it nears the end of the crossfade.

Fade-In Shape [Off, Log, -126...-1, Linear, +1...126, Exp]

This sets the shape for the second step's fade-in within the crossfade.

Off means that the step will start to sound at full volume at the very beginning of the crossfade.

Log means that the step will fade in quickly at first, and then move more slowly as it nears the end of the crossfade.

Linear means that the step will fade in steadily over the duration of the crossfade.

Exp means that the step will fade in slowly at first, and then moved more rapidly as it nears end of the crossfade.

AMS Out 1 [0...127]

Sets the step's first AMS output. You can use this as a modulation source for any AMS destination—for instance, to change the filter cutoff or pan position for each step. For more information, see "Modulating Program parameters per step" on page 187 of the OG.

AMS Out 2 [0...127]

This sets the step's second AMS output.

Wave Sequence step Durations, Crossfade times, and Fade-In and Fade-Out shapes

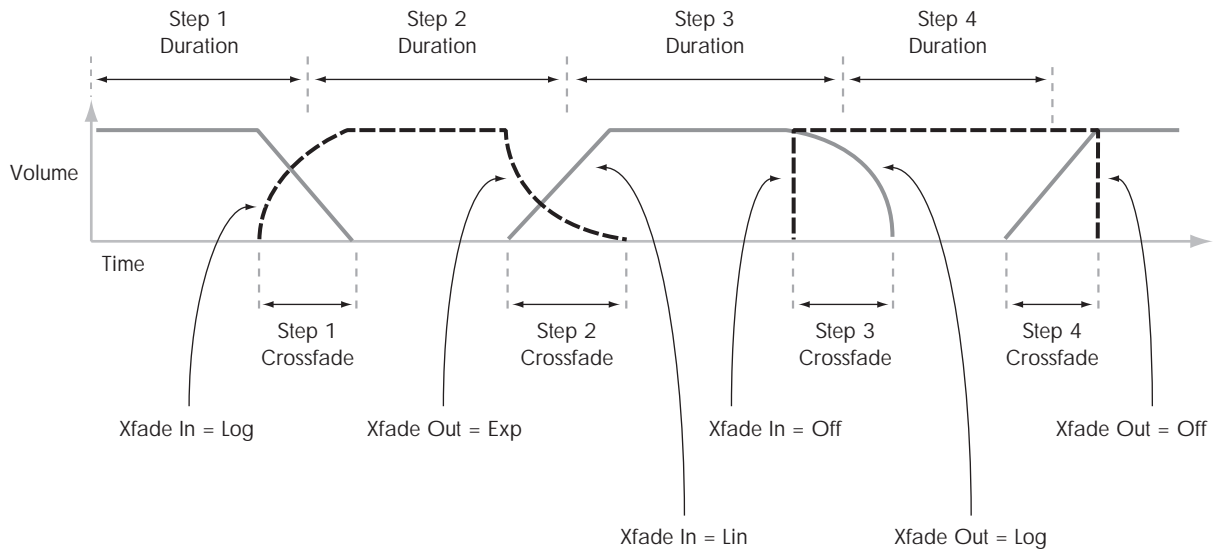

2-2d: Command buttons

Insert

This command inserts the previously **Cut** or **Copied** step before the current step.

Cut

This command removes the current step from the Wave Sequence, and moves the subsequent steps forward. The removed step can then be **Pasted** or **Inserted** into another location, if desired.

Copy

This command copies current step. You can then **Paste** or **Insert** the step into another location.

Paste

This command replaces the current step with the previously **Cut** or **Copied** step.

Exp/Comp (Mode = Time)

This command appears only when the **Mode** is set to **Time**. It brings up a dialog box, which allows you to expand or compress all of the duration and crossfade times by a specified percentage.

Duration Time dialog box

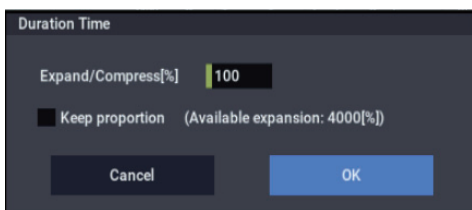

Expand/Compress [%] [0...100,000]

100% means the current duration and crossfade times. Values 99 and below make the times shorter, and values 101 and above make them longer.

/2 (Mode = Tempo)

This command appears only when the **Mode** is set to **Tempo**. It cuts the step durations and/or **Multiply Base Note** settings in half, so that 1/4 notes become 1/8 notes, 1/8 notes become 1/16 notes, and so on.

x2 (Mode = Tempo)

This command also appears only when the **Mode** is set to **Tempo**. It multiplies the step durations and/or **Multiply Base Note** settings by two, so that 1/8 notes become 1/4 notes, 1/4 notes become 1/2 notes, and so on.

✓ 2-2: Page Menu Commands

- Compare →p.112
- Write Wave Sequence →p.692
- Remap MS/Sample Banks →p.121
- PAGE →p.126
- MODE →p.126

GLOBAL > Category Name

Programs, Combinations, and Arpeggiator are organized into categories and sub-categories. Categories make it easy to find a particular type of sound, such as keyboards, bass, or drums.

Each main category also has up to 8 sub-categories, for finer degrees of organization. For instance, the Program keyboard category has sub-categories for acoustic pianos, real electric pianos, synth electric pianos, and clavs and harpsichords.

Anywhere that you can select Programs, or Combinations by bank and number, you can also select them from the category pop-up.

When shipped from the factory, there are 16 preset Program and Combination categories, with 2 more left open for your use (initially named User16 and User17).

On these pages, you can:

- Change the names of any of the categories and sub-categories, including both the factory and user categories
- Add sub-categories to the factory categories (up to the limit of 8)

You can assign a Program or Combination to a category and sub-category during the Write process. For more information, see “Write Program” on page 112, and “Write Combination” on page 433.

- 🔧 To save changes to category names, you’ll need to write the Global settings. To do so, use the menu command “Write Global Setting.” For more information, see “Write Global Setting” on page 686.

3-1: Program Category

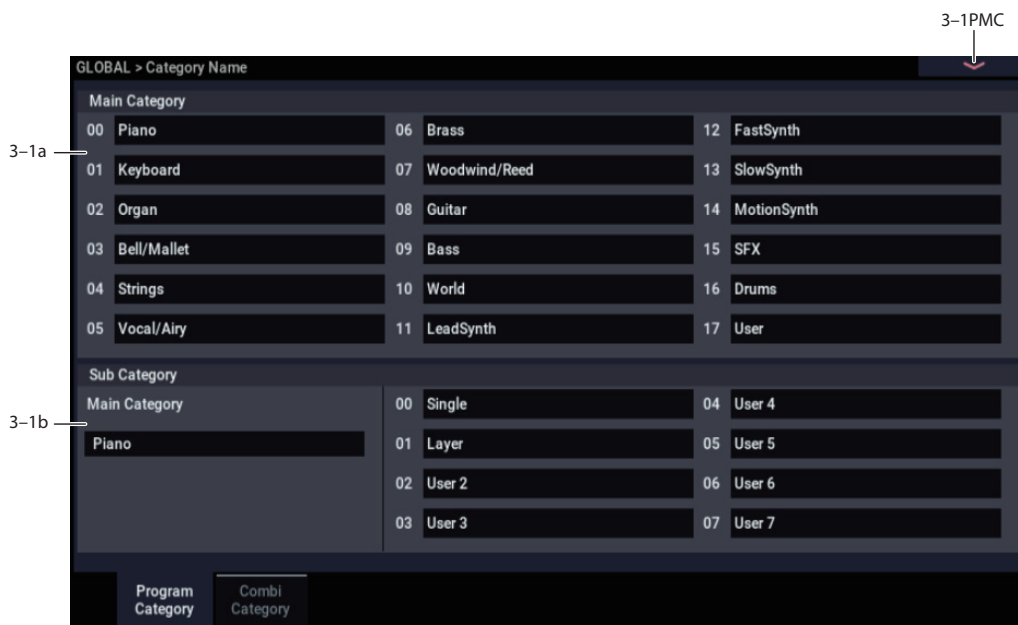

3-1a: Main Category

Main Category 00...17

Main Category Edit [(Text Editor)]

Here you can edit the names of the eighteen Main Categories for Programs.

To rename a Main Category, press its text edit button to open the text edit dialog box, and enter a name (up to 24 characters).

If a USB QWERTY keyboard (commercially available) is connected, you can use this to enter text instead of the on-screen keyboard. For more information, see “Editing names and entering text” on page 206 of the OG.

3-1b: Sub Category

Main Category select [00...17]

Each of the Main Categories can have eight Sub Categories. Select the Main Category whose Sub Category names you’d like to edit.

Sub Category 00...07

Sub Category Edit [(Text Editor)]

Here you can edit the names of the eight Sub Categories within the selected Main Category. Editing the names works the same as for the Main Categories, as described above.

✓ **3-1: Page Menu Commands**

- Write Global Setting →p.686
 - PAGE →p.126
 - MODE →p.126
-

3-2: Combi Category

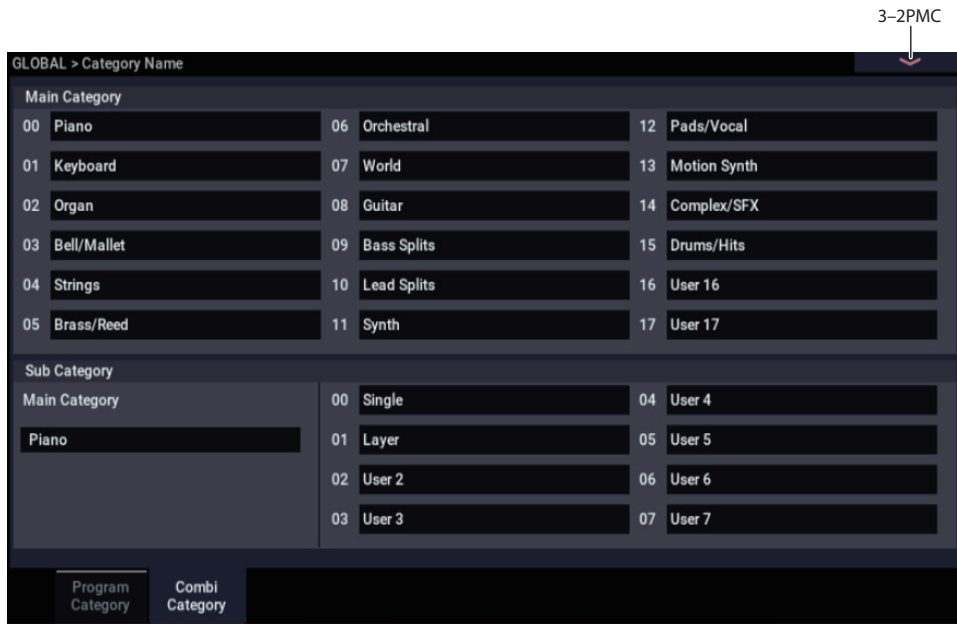

This specifies the combination category and sub-category names. For more information, see “3-1: Program Category”.

✓ **3-2: Page Menu Commands**

- Write Global Setting →p.686
- PAGE →p.126
- MODE →p.126

GLOBAL > Drum Kit

Drum Kits, as the name implies, are optimized for creating drum sounds. They are created and edited here in GLOBAL mode, and can then be used in PROGRAM > Basic/X-Y/Controllers– Program Basic page. You can process them through the HD-1’s filter, amp, drive, effects, and so on, similar to Multisamples or Wave Sequences.

For detailed step-by-step instructions on using and editing Drum Kits, please see “Using Drum Kits” on page 193 of the OG.

Before editing Drum Kits

First, select a Drum Program

While you’re in GLOBAL mode, you’ll play the kit that you’re editing as if you were playing it from within the Program, Combi, or Song which was selected before you entered GLOBAL mode.

So, before you enter GLOBAL mode, it’s best to select a Program which is already set up for drums, with the appropriate EG settings, effects, and so on. Just use the Program Category select popup, and choose a drum Program such as “Studio Standard Kit.”

Note: If you select a Double Drums Program before entering GLOBAL mode, the Drum Kit from Oscillator 1 will be selected and ready for editing. When editing in GLOBAL mode, the selected Drum Kit will always play as if it were in the Program’s Oscillator 1.

The Drum Kit in Oscillator 2 will continue to sound as well, although you can’t edit it directly.

OSC1/Basic Octave setting

In order for the note mappings to match the keyboard, the Oscillator’s **Octave** setting needs to be **+0 [8’]**. All Drum Kit Programs should have this setting already. If you’re unsure, you can check this yourself:

1. Go to the **OSC1/Basic** tab of the **OSC/Pitch** page.
2. Check that the **Octave** parameter (near the top of the page) is set to **+0 [8’]**.

With a setting other than **+0 [8’]**, the relationship between the keys and the Drum Kit sound map will be incorrect.

Make sure that Memory Protect is disabled

Before you start editing, go to the Global Basic page, and look in the Memory Protect section. Make sure that **Drum Kit** is not checked—if so, you won’t be able to make any edits.

Drum Kits may be used by more than one Program

When you edit a Drum Kit, all Programs that use that Drum Kit will be affected. To avoid changing the factory voicing, you may wish to copy Drum Kits to empty locations in the USER banks before editing.

 If you turn off the power or select another drum kit before writing, your edits cannot be recovered. To save your edits, use the **Write Drum Kit** page menu command to open the Update Drum Kit dialog box.

 If “Enable Exclusive” (1–1c) is checked, the drum kit can be edited via MIDI System Exclusive data.

4-1: Sample Setup

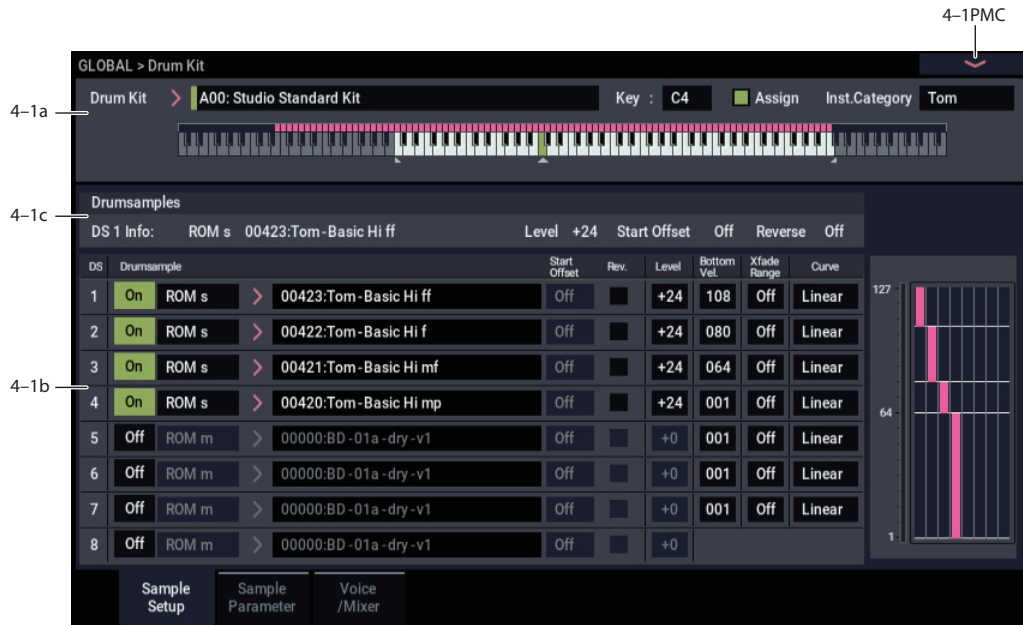

This page lets you assign sounds to each key in the Drum Kit. A single key is shown at a time. Each key can have up to 8 Drum Samples (DS1–8), and each DS has its own settings for start offset, reverse on/off, level, and velocity zone. For additional DS parameters, see “4-2: Sample Parameter” on page 671 and “4-3: Voice/Mixer” on page 673.

For more information on Drum Kits, see “Using Drum Kits” on page 193 of the OG.

4-1a: Drum Kit, Key Select, Assign

Drum Kit [A00...39, B00...O15, GM0...GM8]

Selects the Drum Kit that you wish to edit.

When the Drum Kit Select window is open, you can use the Find button to search for Drum Kits by name. For more information, see “Find dialog” on page 7.

Drum Kit bank contents

| Bank | Contents |
|----------------------|-------------------|
| A00...A39, B00...E15 | Factory Drum Kits |
| F00...O15 | User Drum Kits |
| GM 0...8 | GM2 Drum Kits |

Note: GM0–GM8 are GM2-compatible preset Drum Kits. As with GM bank Programs, they can be edited but must be saved to a non-GM location.

KEY [C-1...G9]

Selects the key to which the drum sample (and its settings) will be assigned.

Use the VALUE controller to specify the key. You can also select the key by holding down the ENTER button and playing a note on the keyboard. You can assign up to eight drum samples (DS1...8) to each key, and switch between them by velocity.

If you check **Assign** for the key you select here, the DS1...8, Voice Assign Mode, and Mixer parameters (see below) will be used.

Drum Kit, Key Select, Assign

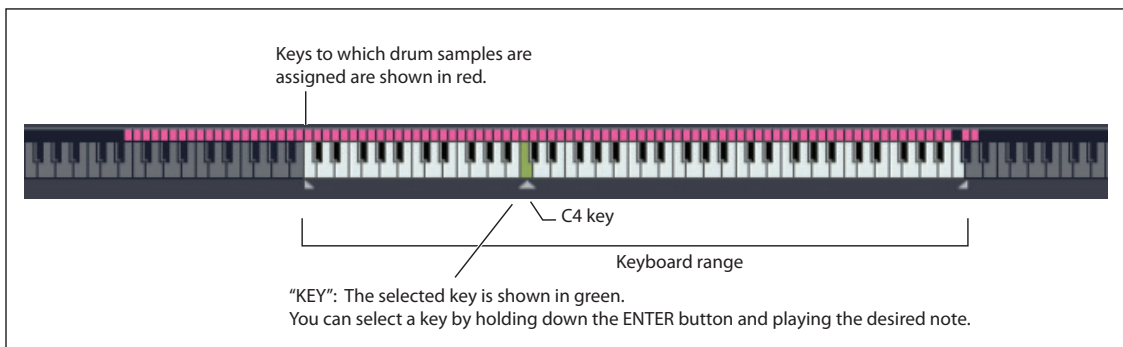

Assign [Off, On]

On (checked): The drum samples you assigned for DS1-4 will sound. Normally you will check this parameter.

Off (unchecked): The selected drum samples will be invalid, and the drum samples of the key to the right will sound. At this time, the pitch will be a semitone lower than the pitch of the key to the right. Uncheck this parameter when you wish to play a drum sample at differing pitches.

Inst. Category [Kick...Else]

Sets the category for the drum instruments assigned to each key.

4-1b: Drumsample

You can specify up to eight Drum Samples. The process is the same as for Multisample s in the HD-1. “Bottom Velocity” and “Xfade Range” specify the velocity zones for each of the Drum Samples.

DS1 (Drum Sample1):

These are the settings for the highest velocity zone.

If you want to create a simple setup using only one drum sample, without velocity switching, use only DS1, and set its “Bottom Velocity” to 1 and “Xfade Range” to Off. Then, make sure that DS2...8 are all turned off.

To use two or more velocity switches or crossfades, start with DS1 and work downwards. For instance, for a three-way velocity switch, use DS1...3.

On **DS1 On/Off** [Off, On]

On (checked): Check this if you want to use DS1 (High). The selected drum sample will sound.

Off (unchecked): DS1 (High) will not be used. The drum sample will not sound.

Bank [List of Multisample Banks]

Drumsample Select [000...416, 0000...15999, 000...]

This lets you select a Drum Sample for DS1.

There are four types of Multisample Banks: **ROM**, **SAMPLING mode**, **EXs**, and **User Sample Banks**. For each type, you can also choose between looking at mono and stereo Drum Samples. Note that stereo Drum Samples will require twice as many voices as mono Multisamples.

ROM: These are the NAUTILUS’s standard Drum Samples.

Smp (SAMPLING Mode) Samples are the ones that you can see and edit in SAMPLING mode. After the abbreviation “Smp,” several different things may appear, as described below.

Smp: Old RAM means that this is an older Drum Kit pointing to the legacy “RAM” bank. Instead of pointing to a specific User Sample Bank, it will use whatever Sample data is loaded into SAMPLING mode.

Smp: New Sampling Session will appear when there’s data in SAMPLING mode which hasn’t yet been saved to drive as a User Sample Bank. For instance, this might happen if you’ve loaded an old KSC file, loaded individual Samples or Multisamples, or recorded some new samples. Once the KSC is saved to drive, the name will update to show the file path (as described below).

Smp: [file name] will appear when a User Sample Bank has been loaded into SAMPLING mode. The name is the file name itself along with those of all its enclosing folders.

EXs: These are the NAUTILUS’s EXs drum samples. The number of drum samples will differ depending on the EXs. The NAUTILUS ships with 9 EXs banks. Note that some EXs banks may not contain drum samples.

When the Drum Sample Select window is open, you can use the Find button to search for Drum Samples by name. For more information, see “Find dialog” on page 7.

ROM/EXs mono and stereo

When you press the “Drumsample Select” popup button a drum sample list will appear, allowing you to choose drum samples from the list.

Use the tabs to choose a category, and then choose a drum sample from within the category. Press the OK button to execute, or press the Cancel button to cancel.

 It is not possible to edit the category names of drum samples, or to re-assign the category.

ROM Mono and EXs Mono: Mono drum samples will be displayed. The individual left and right channels of ROM and EXs stereo drum samples can also be selected as mono drum samples. In these cases, -L or -R is shown following the drum sample name.

ROM Stereo and EXs Stereo: Only stereo drum samples will be displayed.

SAMPLING mode and User Sample Bank mono and stereo

Use the tabs to select a group of one thousand, and then choose a Sample within that group. Press the OK button to execute, or press the Cancel button to cancel.

Mono: Mono drum samples will be displayed. The L-channel or R-channel of stereo drum samples can also be selected as mono drum samples. In these cases, -L or -R is shown following the drum sample of the same name.

Stereo: Only stereo drum samples will be displayed, using the same numbers and names as the mono samples. The same stereo sample will be specified regardless of whether you select -L or -R.

Start Offset [Off, 1st...8th]

In addition to simply starting playback from the beginning, ROM and EXs Drum Samples can have up to 8 different pre-programmed alternate starting points. Similarly, SAMPLING mode and User Sample Bank Drum Samples can play either from the beginning of the waveform, or from the loop start point.

With ROM and EXs Drum Samples, the Start Offset specifies whether to use the normal start point (**Off**), or to use one of the alternate start points (**1st-8th**).

Some ROM and EXs Drum Samples may have fewer than 8 pre-programmed points, in which case only the available points can be selected.

With SAMPLING mode and User Sample Bank Drum Samples, only **Off** and **1st** are available. **Off** uses the normal start point, and **1st** uses the loop start instead. **2nd** through **8th** will be grayed out.

Reverse [Off, On]

This lets you play the selected drum sample backwards, without looping.

On (checked): The drum sample will play back in reverse.

The location at which reverse playback starts and ends is already specified for each drum sample. In the case of RAM bank samples whose “Start” and “End” (SAMPLING 2–1d) are specified, the sample will play (backward) from “End” to “Start.”

Off (unchecked): The drum sample will play back normally.

 This parameter will not change the playback direction of a sample for which “Reverse” (SAMPLING 2–1d) is checked.

Note: Reverse is not available for EXs or User Sample Bank Multisamples loaded using Virtual Memory. To use reverse with this data, set the Load Method to RAM. For more information, see “Change load method” on page 644.

Level (Amp Level) [-99...+99]

Specifies the volume.

Keys for which a value of +99 is specified will sound at a volume twice as high as the amp level of the program which uses that drum kit. Keys for which a value of 0 is specified will sound at the volume of the amp level of the program which uses that drum kit.

Keys for which a value of -99 is specified will not sound.

Bottom Velocity [1...127]

This sets the lowest velocity at which the drum sample will sound. DS1’s Bottom Velocity can be equal to, but not lower than, than that of DS2.

Xfade Range [Off, 1...127]

This specifies the velocity range starting at “Bottom Velocity” over which DS1 will fade-out and DS2 will fade-in.

For instance, if the Bottom Velocity is set to 64, and the Xfade Range is set to 20, DS2 will start to fade in at velocities of 84 and below.

When velocities are within the Xfade Range, the Oscillator will use twice as much polyphony as it would normally.

Note: You can only fade between two zones at once.

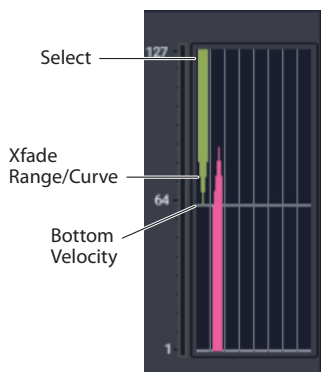

Curve [Linear, Power, Layer]

This controls the volume curve of the crossfade. **Linear** and **Power** (short for Equal Power) let you fine-tune the way that the two drum samples mix together; one or the other may be

more appropriate for a given pair of drum samples. **Layer**, true to its name, lets you layer the two drum samples together without any crossfading.

Linear means that the two samples will each be at 50% of their full volume in the middle of the crossfade. Sometimes, this may create a dip in the volume level; if so, try using **Power** instead.

Power, short for Equal Power, means that the two samples will each be at around 70% of their full volume in the middle of the crossfade. Sometimes, this may create a bump in the volume level, in which case you might try selecting **Linear** instead.

Layer means that the two drum samples will be layered together, both at full volume, for the entire range of the crossfade.

Crossfade Curves

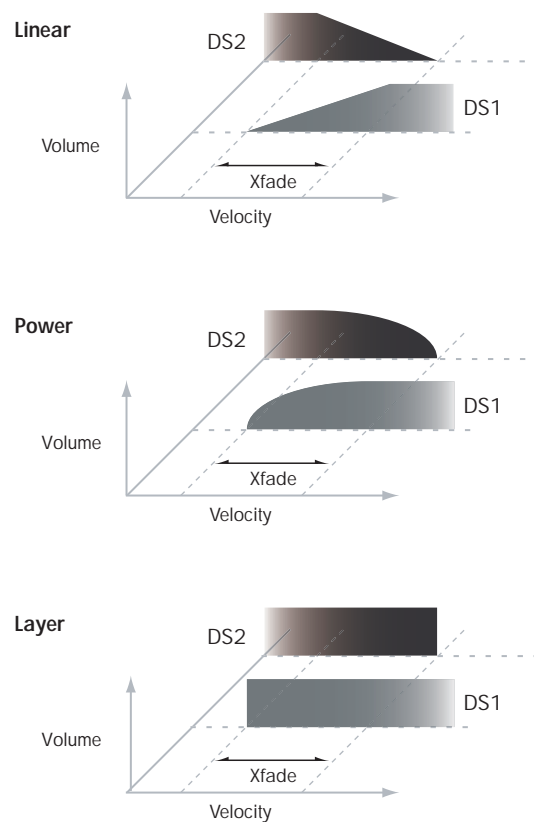

DS2...7 and DS8

These are the settings for the remaining velocity zones. The parameters for DS2...7 are exactly the same as those for DS1, as described above.

The parameters for DS8 are also similar to those for DS1, except that DS8 has no settings for Bottom Velocity (which is always fixed at 1), Xfade Range, or Curve.

4-1c: Drumsamples

Shows the information of the currently selected DS number.

✓ 4-1: Page Menu Commands

- Compare →p.112
- Write Drum Kit →p.693
- Copy Key Setup →p.693
- Swap Key Setup →p.693
- PAGE →p.126
- MODE →p.126

4-2: Sample Parameter



Here you can edit the attack and decay, tuning, filter cutoff and resonance, and three-band EQ settings for each drum sample. These settings are offsets that are applied to the settings of the program.

4-2a: Drumsample Parameters

DS1 (High): (Drum Sample 1 High)

DS1(High) On/Off [Off, On]

On (checked): Check this if you want to use DS1 (High). The selected drum sample will sound.

Off (unchecked): DS1 (High) will not be used. The drum sample will not sound.

Attack (Amp EG Attack) [-64...+63]

Adjusts the attack time of the volume (Amplifier). The attack time for each key is determined by adding this value to the amp EG Attack Time of the Program that uses this drum kit.

Decay (Amp EG Decay) [-64...+63]

Adjusts the decay time of the volume (Amplifier). The decay time for each key is determined by adding this value to the amp EG Decay Time of the Program that uses this drum kit.

Transpose [-64...+63]

Adjusts the pitch in semitone steps.

+12 is one octave up, and -12 is one octave down.

Tune [-99...+99]

This adjusts the pitch in cents, over a range of ±1 octave. A cent is 1/100 of a semitone.

Drive [-99...+99]

This adjusts the drive level. This offset value for each key and drum sample is applied to the driver “Drive” (PROGRAM 4-1a) setting of the programs that use this drum kit.

Low Boost (Driver Low Boost) [-99...+99]

This adjusts the low boost level of the driver. This low boost setting for each key and drum sample is applied to the driver “Low Boost” (PROGRAM 4-1a) setting of the programs that use this drum kit.

Filter Cutoff [-64...+63]

Adjust the cutoff frequency of the filter. The cutoff frequency for each key and drum sample is determined by adding this value to the filter **Frequency** (PROGRAM 3-1b) of the program that uses this drum kit.

Resonance (Filter Resonance) [-64...+63]

This adjusts the filter resonance. This offset value for each key and drum sample is applied to the filter “Resonance” (PROGRAM 3-1b) of the programs that use this drum kit.

3 Band Parametric EQ [dB]

Low [-36.0...+36.0]

Mid [-36.0...+36.0]

High [-36.0...+36.0]

These parameters adjust the gain for each band of the three-band parametric EQ. The gain settings for each key and drum sample are applied to the “Low Gain,” “Mid Gain,” and “High Gain” (PROGRAM 4–9a) settings of the programs that use this drum kit.

DS2...7 and DS8(Low)

These are the parameters for the remaining drum samples. The parameters are the same as those of DS1, as described above.

4–2b: Drumsamples

Shows the information of the currently selected DS number.

✓ 4–2: Page Menu Commands

- Compare →p.112
- Write Drum Kit →p.693
- Copy Key Setup →p.693
- Swap Key Setup →p.693
- PAGE →p.126
- MODE →p.126

4-3: Voice/Mixer

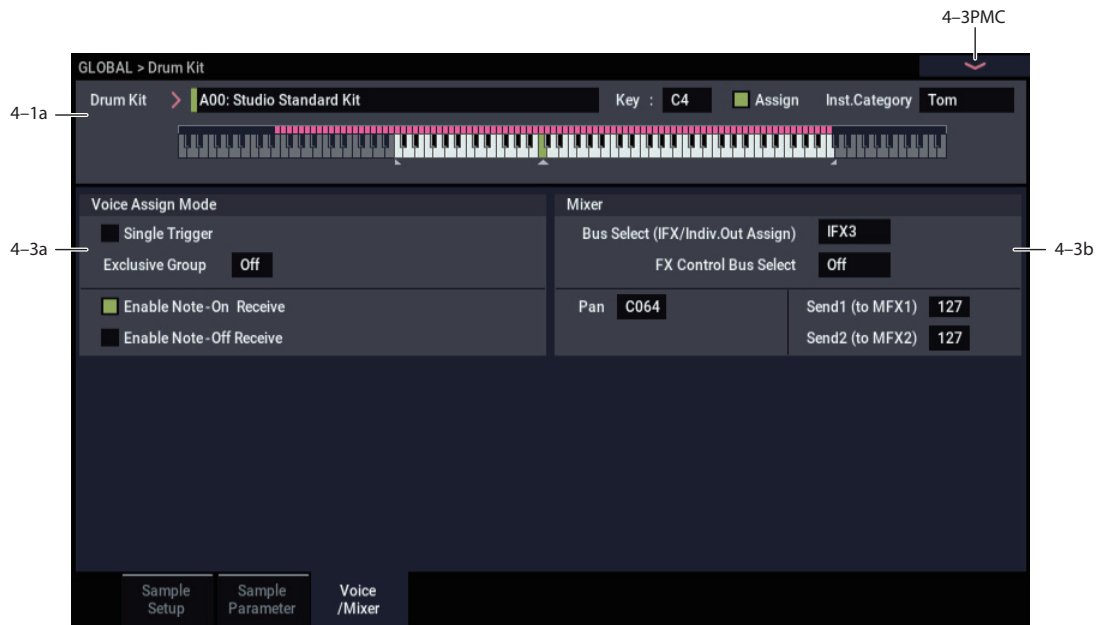

Specify the voice assign, pan, and effect routing etc. for each key of the drum kit.

4-3a: Voice Assign Mode

Single Trigger [Off, On]

On (checked): Even when the same key (note) is played repeatedly, the previous note will be halted before the new note is begun, so that the notes will not overlap. Normally you will leave this unchecked.

Exclusive Group (Exclusive Assign) [Off, 001...127]

001-127: This allows you to assign keys to any of 127 groups. Keys assigned to the same group will be treated as a single group, and will be played monophonically with last-note priority. For example you might assign closed and open hi-hat sounds to the same group so that two or more hi-hat sounds can not sound simultaneously.

Off: Keys will not be grouped. This is the default setting.

Enable Note On Receive [Off, On]

On (checked): Note-on messages will be received. Normally you will check this, but you can uncheck it if you do not want specific notes to sound.

Enable Note Off Receive [Off, On]

On (checked): Note-off messages will be received. Normally you will uncheck this. This parameter is valid when “Hold” (PROGRAM 1-1d) is checked (Hold On). In the case of a drum program, you will normally select Hold On. In this case if “Enable Note Off Receive” is checked, note-off messages will be received, and the sound will stop (the release segment of the EG will begin) when the key is released.

4-3b: Mixer

Drum kits will sound using the settings of the program that is selected in PROGRAM mode. **Pan** is valid if “Use DKit Setting” (PROGRAM 4-1c) is checked. **Bus Select**, **FX Control Bus**, and “Send 1/2” are valid if “Use DKit Setting” (PROGRAM 8-1b) is checked. Be aware that while editing a drum kit, the edited results will not be reflected unless these settings have been made.

Bus Select (IFX/Indiv.Out Assign) [L/R, IFX1...12, 1...4, 1/2...3/4, Off]

For each key, you can specify the bus to which the sound will be sent.

For example, you might send Snare sounds to IFX1 and Kick sounds to IFX2 to apply separate insert effects, and send the remaining sounds to L/R without applying insert effects.

Tip: In most of the preloaded drum kits, the following types of drum instrument have the same **Bus Select** settings.

Tip: Most of the preloaded drum kits use the same basic **Bus Select** settings, as shown below:

Snares → IFX1
 Kicks → IFX2
 Toms → IFX3
 Cymbals → IFX4
 Percussion etc. → IFX5

FX Control Bus [Off, 1, 2]

For each key, you can select whether the signal will be sent to FX Control bus (stereo two-channel) FX Ctrl1 or 2.

Normally you will leave this off, but you can use this setting if you want to control an effect by playing a specific key.

You can use this with the following effects:

Vocoders:

- 026: Vocoder

Compressor and gate-type effects:

- 002: Stereo Compressor
- 003: Stereo Expander
- 005: Stereo Limiter
- 009: Stereo Gate
- 010: Stereo Noise Reduction

Example: Gated Reverb

This is an example of applying a gated reverb to only a specific snare sound. When using a gate effect on reverb, you may not be able to control the gating timing correctly if you use the extended reverberant sound to control the gate. Normally, you will control the gate using sound from before reverb is applied.

For the key for which you've selected the snare sample, set **Bus Select** to IFX6. Also use **FX Control Bus Select** to send the signal to FX Control Bus 1. In IFX7: Stereo Gate, choose FX Control 1 as the Envelope **Source**. Now you can use a signal other than the input (reverberant sound) to control the gate.

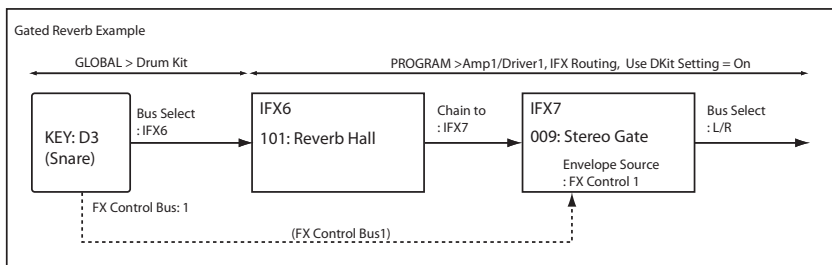

Pan [Random, L001...C064...R127]

Specifies the panning for each key.

L001 places the sound at far left, and **R127** places the signal at far right. With a setting of **Random**, the drum sample will be panned randomly at each note-on.

Send1 (to MFX1) [000...127]

Send2 (to MFX2) [000...127]

For each key, specify the send levels to master effects 1 and 2.

These settings are valid when **Bus Select (IFX/Indiv.Out Assign)** (4-3b) is set to L/R or Off. If **Bus Select** is set to IFX1-12, the send level to master effects 1 and 2 will be determined by the PROGRAM, COMBINATION, or SEQUENCER mode IFX-Insert FX page parameters **Send1** and **Send2** which are located after the sound passes through IFX1-12.

✓ 4-3: Page Menu Commands

- Compare →p.112
- Write Drum Kit →p.693
- Copy Key Setup →p.693
- Swap Key Setup →p.693
- PAGE →p.126
- MODE →p.126

GLOBAL > Controllers/Scales

5-1: Controllers



5-1a: Foot Switch & Pedal/Damper

Foot Switch Assign [Off...SW 2]

This selects the function that will be controlled by a pedal switch (such as the optional Korg PS-1) connected to the ASSIGNABLE SWITCH jack.

For a complete list of possible assignments, please see “Foot Switch Assignments” on page 917.

Foot Pedal Assign [Off...Knob 4]

Selects the function that will be controlled by a volume pedal (such as the optional XVP-20 or EXP-2) connected to the ASSIGNABLE PEDAL jack.

For a complete list of possible assignments, please see “Foot Pedal Assignments” on page 919.

Foot Pedal Behavior [Keep Current, Reset]

This determines what happens to the Foot Pedal value when you select a new Program, Combination, or Song.

Keep Current: The sound will use the actual physical position of the pedal. For instance, this allows you to switch between different CX-3 sounds without resetting the **Expression** value.

Reset: The sound will act as if the pedal was reset to the maximum value. Use this if you would prefer for your sounds to start with a clean slate.

Damper Polarity [(-) Korg Standard, (+)]

Set this to match the polarity of the damper pedal connected to the DAMPER jack. If the polarity does not match, operating the damper pedal will not produce the correct result. If no damper pedal is connected, set this to (-) Korg Standard.

(-) Korg Standard: Use this setting for “open-type” damper pedals, such as the optional Korg DS-1H.

(+): Use this setting for “closed-type” pedals.

Foot Switch Polarity [(-) Korg Standard, (+)]

Set this to match the polarity of the footswitch connected to the ASSIGNABLE SWITCH jack. If the polarity does not match, operating the damper pedal will not produce the correct result. If no damper pedal is connected, set this to (-) Korg Standard.

(-) Korg Standard: Use this setting for “open-type” footswitches, such as the optional Korg PS-1.

(+): Use this setting for “closed-type” pedals.

5-1b: MIDI CC# Assign - Controllers

All of the ARP/DRUM controls can optionally be assigned to Control Change messages (CCs). When you operate a button or RT control knob, the assigned CC will be transmitted via MIDI; when received from MIDI input, the CC will control the corresponding ARP/DRUM function.

Default CC assignments

As shipped from the factory, for simplicity, all ARP and Pad assignments are set to Off. However, the NAUTILUS has a set of recommended CC assignments which can be loaded in a single step. To do so:

1. **Select the menu command Reset Controller MIDI Assign.**

A dialog box will appear.

2. **Set the To menu to CC Default.**

3. **Press OK.**

The controls for ARP, the pads, and the X-Y Control will all be set to their recommended CC assignments. For more information, see “Reset Controller MIDI Assign” on page 692.

If you prefer, you may also manually assign the controls to any other CCs. Make sure to write the Global settings in order to preserve your edits!

LATCH [Off, MIDI CC#00...119]

This assigns a control change message to the ARP LATCH switch. When assigned to a CC, the default is CC#31.

ARP [Off, MIDI CC#00...119]

This assigns a control change message to the ARP button. When assigned to a CC, the default is CC#14.

DRUM [Off, MIDI CC#00...MIDI CC#119]

Assigns control change messages to the DRUM button.

GATE [Off, MIDI CC#00...MIDI CC#119]

Assigns control change messages to the ARP/DRUM Gate knob.

VELOCITY [Off, MIDI CC#00...MIDI CC#119]

Assigns control change messages to the ARP/DRUM Velocity knob.

LENGTH [Off, MIDI CC#00...MIDI CC#119]

Assigns control change messages to the ARP/DRUM Length knob.

SWING [Off, MIDI CC#00...MIDI CC#119]

Assigns control change messages to the ARP/DRUM Swing knob.

DRUM SD [Off, MIDI CC#00...MIDI CC#119]

Assigns control change messages to the ARP/DRUM Drum SD knob.

X-Y Control X [Off, MIDI CC#00...MIDI CC#119]

Assigns control change messages to the X-Y control in the X direction.

X-Y Control Y [Off, MIDI CC#00...MIDI CC#119]

Assigns control change messages to the X-Y control in the Y direction.

✓ 5-1: Page Menu Commands

- Write Global Setting →p.686
- Reset Controller MIDI Assign →p.692

- PAGE →p.126
- MODE →p.126

5-2: User Scales



Here you can make settings for sixteen different User Octave Scales and one User All Notes scale.

The user scales you create here can be selected from the following pages.

- (HD-1) PROGRAM > Basic/X-Y/Controllers– Program Basic
- (EXi Common) PROGRAM > Basic/X-Y/Controllers– Program Basic
- COMBINATION > Timbre Parameters– Pitch
- SEQUENCER > Track Parameters– Pitch

 If you wish to keep an edited user scale after the power is turned off, be sure to write (save) your settings.

Use the page menu command **Write Global Setting** to open the dialog box, and write the data.

5-2a: User Octave Scale

User Octave Scale [User Octave Scale 00...15]

Selects the User Octave Scale that you want to edit.

Tune [-99...+99]

Makes pitch settings for each note in the octave.

When you adjust the pitch of each note in the octave (C–B) in one-cent steps, your settings will be applied to all octaves. This adjustment is relative to equal temperament.

A setting of **-99** lowers the pitch approximately a semitone below normal pitch.

A setting of **+99** raises the pitch approximately a semitone above normal pitch.

The note can also be selected by holding down the ENTER button and playing a note on the keyboard.

By executing the page menu command “Copy Scale,” you can copy settings from a preset scale (other than Stretch) or from another user scale.

5-2b: User All Notes Scale

Tune [-99...+99]

Makes independent pitch settings for each of the 128 notes.

Adjust the pitch of each of the 128 notes (C–1 – G9) in one-cent steps. This adjustment is relative to equal temperament.

A setting of **-99** lowers the pitch approximately a semitone below normal pitch.

A setting of **+99** raises the pitch approximately a semitone above normal pitch.

Use the horizontal scroll bar to move to the key range that you want to set, and select the key that you want to specify.

The note can also be selected by holding down the ENTER button and playing a note on the keyboard.

By executing the page menu command “Copy Scale,” you can copy settings from a preset scale (including Stretch) or another user scale.

✓ 5-2: Page Menu Commands

- Write Global Setting →p.686
- Copy Scale →p.692
- PAGE →p.126
- MODE →p.126

5-3: Function Assign

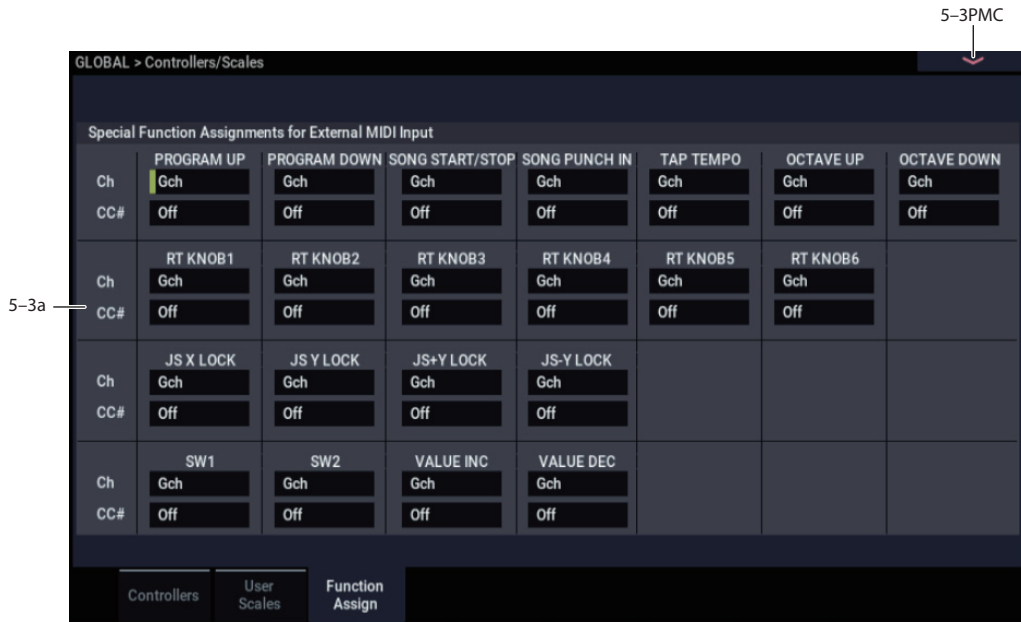

This page is designed for use with external MIDI and USB MIDI controllers in live performance. It allows you to map incoming MIDI CCs to all of the functions available for assignment to the NAUTILUS rear-panel foot switch input or SW1/2. For instance, you can have multiple switches assigned to Program Up, Program Down, Octave Up, Octave Down, Tap Tempo, etc.—all at the same time.

This assignment applies only to external MIDI and USB MIDI input. MIDI CC messages from the controller, arpeggiator and sequencer are ignored.

For each of the functions, you can assign a MIDI Channel (Gch and 1...16) and a CC number (Off, 0...119). The default values are Gch and Off; a menu command, **Clear Special Function Assignments**, resets all assignments to these defaults.

Note: CCs assigned on this page will continue to perform their normal functions as well, so choose them carefully in order to avoid unintended results. It may be helpful to refer to “Responses to standard MIDI controllers” on page 923.

Note: The **Function Assign** settings are saved automatically, and are not part of the GLOBAL PCG file.

What about Arpeggiator controls?

From the GLOBAL > Controllers/Scales– Controllers page, you can assign MIDI CC to the RT control knobs 1–5, which are used when ARP/DRUM is selected with the SELECT button. For more information, see “5-1b: MIDI CC# Assign - Controllers” on page 675.

5-3a: Special Function Assignments for External MIDI Input

All of the assignments have the same two parameters, **MIDI Channel** and **CC# Assign**, as described below.

MIDI Channel [1...16, Gch]

This sets the MIDI Channel on which the function’s MIDI CC will be received, as set below.

Gch means that the selected CC will be received on the Global MIDI Channel, as set in GLOBAL mode.

CC# Assign [Off, 00...119]

This sets the MIDI CC assigned to the function.

If you have changed the settings on this page, they will be saved on the internal drive of the NAUTILUS. Do not turn off the power of the NAUTILUS for at least 10 seconds after making changes.

CC values for on/off and trigger

For functions with on and off states, such as SW1 or SW2, CC values 0–63 turn the function off, and 64–127 turn the function on.

For functions which do not have an “off” state, such as Program Up/Down, Value Inc/Dec, and Tap Tempo, CC values 64–127 trigger the function, while values 0–63 are ignored.

Duplicate entries are prevented

If you attempt to assign the same MIDI Channel and CC# to a second function, an error message will appear as below:

```
Invalid entry for: [name of function being edited]
[existing function name] already has this assignment.
[OK]
```

Program Up and Program Down

These functions increment (Program Up) or decrement (Program Down) the current Program, Combination, or Set List Slot number, for hands-free patch changes. MIDI Program Change and Bank Select messages will also be transmitted as appropriate. CC values 64-127 trigger the function; values 0–63 have no effect.

Important: the NAUTILUS only responds to Program Up and Down while on the PROGRAM > Home or COMBINATION > Home pages, respectively, or while in SET LIST mode.

Song Start/Stop

The selected CC will alternately start and stop the sequencer, and also transmits MIDI Start or Stop messages as appropriate. CC values 64-127 trigger the function; values 0–63 have no effect.

Song Punch In

The selected CC will alternately punch in and out of recording in the sequencer. CC values 64-127 trigger the function; values 0–63 have no effect.

Important: This function is active only when **Recording Setup** is set to **Manual Punch In** on the SEQUENCER > Home—Recording Setup page (see “0–6a: Recording Setup” on page 456).

Tap Tempo

This duplicates the function of the front-panel TAP button, for setting the system tempo in real-time. CC values 64-127 cause a “tap;” values 0–63 have no effect.

Octave Down and Octave Up

These functions transpose the NAUTILUS’s local keyboard up or down by one octave. CC values 64-127 activate the transposition, and values 0–63 turn deactivate it.

Important: Note that these affect the local keyboard only; MIDI input is not transposed.

RT Control Knobs 1...6

The selected CC duplicates the function of the selected RT control knob 1–6. This is particularly useful with RT control knobs 1...6, which may be assigned to different CCs or other functions depending on the selected Program, Combination, or Song.

JS X Lock, JS Y Lock, JS+Y Lock and JS–Y Lock

The Lock functions let you use SW1 or SW2 to “lock” the current position of the joystick, or various combinations thereof. This leaves your hands free to play on the keyboard, or to use other controllers.

For more information, see “Lock functions” on page 915, as well as “Using the Lock function” on page 30 of the OG.

SW1 and SW2

The selected CC duplicates the function of the front-panel switch.

Value Inc and Value Dec

The selected CCs will duplicate the functions of the front-panel + and – buttons. For more information, see “Using a footswitch to select Programs” on page 28 of the OG. CC values 64-127 trigger the + or –; values 0–63 have no effect.

D.TRACK Enable

The selected controller will turn the Drum Track on and off, duplicating the functionality of the front-panel DRUM TRACK button. CC values 0–63 turn the Drum Track off, and values 64-127 turn it on.

✓ 5–3: Page Menu Commands

- Clear Special Function Assignments →p.692
- PAGE →p.126
- MODE →p.126

GLOBAL > Arpeggio Pattern

Here's where you can create user arpeggio patterns.

You can use "Arp Pattern Select" in the ARP DRUM page for each mode (among other places) to select and use the arpeggio patterns you've edited.

Before editing an arpeggio pattern

Selecting a program that will sound

On this page, the program will sound as it was in the mode that was used just before entering GLOBAL mode.

When switching from PROGRAM mode: The arpeggio pattern set in the selected program will be edited here. Even if the arpeggiator was off when you switched from the Program, you can use the ARP button to turn it on.

When switching from COMBINATION mode: The arpeggio pattern set in the selected Combination will be edited here. Even if the arpeggiator was off when you switched from the Combination settings, you can use the ARP button to turn it on. However, the arpeggiator may not sound even when turned on, depending on the settings. Check the arpeggiator MIDI channel settings or the timbre settings.

When switching from SEQUENCER mode: The arpeggio pattern set in the selected Song will be edited here. Even if the arpeggiator was off when you switched from SEQUENCER mode, you can use the ARP button to turn it on. However, the arpeggiator may not sound even when turned on, depending on the settings. Check the arpeggiator MIDI channel settings or the timbre settings.

In the cases above, you can still change the arpeggio pattern settings even while the arpeggiator is not turned on. When editing a pattern, turn the arpeggiator on and make sure that this is the pattern to edit.

Checking the memory protect settings

Before you start editing an arpeggio pattern, go to the "Memory Protect" section of the Global Basic Setup page, and make sure that "ARP Pattern" is off (cleared). If this is selected, you won't be able to save the data.

Things to be aware of when using an arpeggio pattern in multiple Programs

When you edit a arpeggio pattern, this will have an effect on all Programs and Combinations that use that arpeggio pattern. To edit a preloaded arpeggio pattern, you might want to copy it to an unused arpeggio pattern first and then edit it.

 You can save the edited arpeggio patterns on the NAUTILUS from the dialog box in the "Write Arpeggio Patterns" page menu command. If you turn off the power of the NAUTILUS before saving the data, you won't be able to restore it. Also, this save command will save all of the arpeggio patterns.

6-1: Arpeggio Pattern

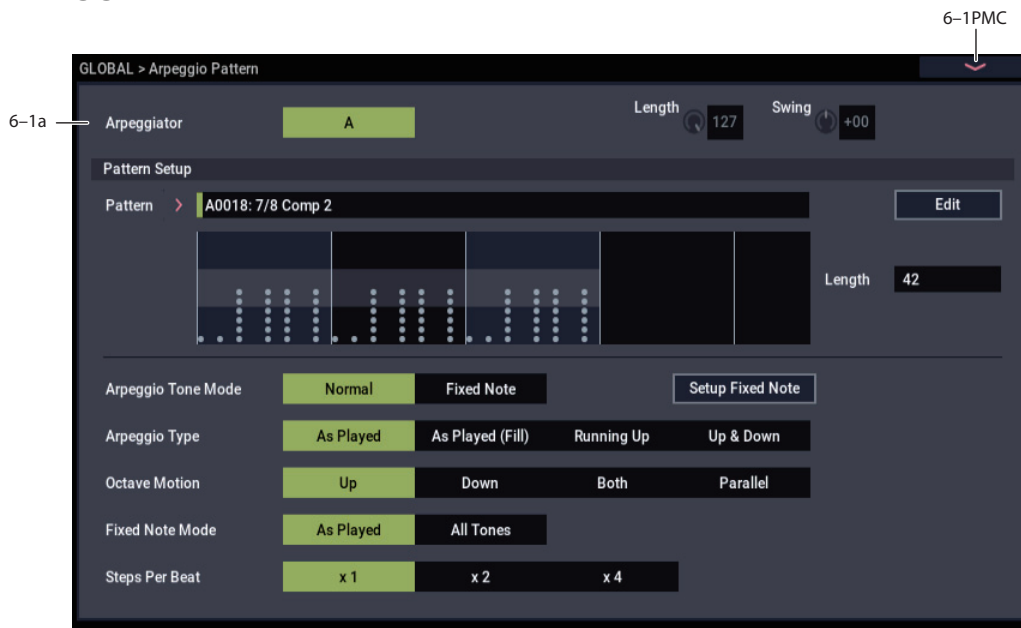

6-1a: Arpeggio Module

Arpeggio Module [A, B]

When you want to edit an arpeggio pattern after switching from the COMBINATION and SEQUENCER modes respectively, select either the A or B arpeggiator. The arpeggiator you select will be the one to edit.

Note: When switching from PROGRAM mode, arpeggiator B will not display.

Length [0...127]

Swing [-64...+63]

Displays the current values for the Length and Swing RT control knobs.

Pattern Setup

The parameters here will be disabled for preset arpeggio patterns P0–P4.

Pattern [P0: UP...P4: RANDOM, A0000...A2047, B000...B127]

Selects the pattern to edit. Although you can select preset arpeggio patterns P0–P4, the parameters here will be disabled for those patterns.

Note: When editing an arpeggio pattern used by a Program (such as a preloaded arpeggio pattern), use the “Copy Arpeggio Pattern” menu command to copy the pattern to an unused number in the A0000...A2047, B000...B127 ranges first.

Note: To change the arpeggio pattern name, use the “Rename Arpeggio Pattern” menu command.

Length

Length (Pattern Length) [01...64]

Specifies the length of the arpeggiator pattern. After the pattern has played the notes specified in “Resolution” in the specified number, the pattern returns to the beginning.

Edit

Opens the ARP Pattern Edit dialog box.

Arpeggio Tone Mode [Normal, Fixed Note]

This sets the Tone type for the arpeggio pattern.

Normal: This is the regular arpeggiator type. The Tone’s scale will be based on the note numbers of the keys you play. The arpeggio will play and notes will sound accordingly.

Fixed Note: A note number will be set for each Tone. The Tone’s scale will ignore the note numbers of the keys you play. Instead, the note numbers set in the Tone will play and notes will sound accordingly. The note numbers from the keyboard will only control the timing of the arpeggiator trigger. This is optimal for arpeggio patterns that are used in drum patterns and similar applications.

The Tones in Arpeggio Pattern Preview will display as circles (“●”) when this setting is “Normal”, and as diamonds “◆” when this setting is “Fixed Note”.

Arpeggio Type [As Played...Up&Down]

Specifies the relationship between the arpeggio notes specified from the keyboard and the Tone at each step.

As Played: If there are more Tones in a step than arpeggio notes specified (notes played on the keyboard), those steps will not sound.

As Played (Fill): If there are more Tones in a step than arpeggio notes specified (notes played on the keyboard), the last-played note (**Sort** is Off), or the highest note (**Sort** is On) will sound for those steps.

Running Up: If there are more Tones in a step than arpeggio notes specified (notes played on the keyboard), the arpeggio will return to the first note (if **Sort** is Off), or the lowest note (if **Sort** is On) and sound it.

Up&Down: If there are more Tones in a step than arpeggio notes specified (notes played on the keyboard), the arpeggio will return in reverse direction from the last arpeggio note back toward the first.

Example

If you set **Length** to 04, **Step No.** 01 to Tone0, **Step No.** 02 to Tone1, **Step No.** 03 to Tone2, **Step No.** 04 to Tone3, and simultaneously play three notes to produce an arpeggio, the following results will be produced depending on the **Arpeggio Type**.

As Played: 0 → 1 → 2 → rest → 0 → 1 → 2 → rest → 0 ...

As Played (Fill): 0 → 1 → 2 → 2 → 0 → 1 → 2 → 2 → 0 ...

Running Up: 0 → 1 → 2 → 0 → 0 → 1 → 2 → 0 → 0 ...

Up&Down: 0 → 1 → 2 → 1 → 0 → 1 → 2 → 1 → 0 ...

Octave Motion [Up, Down, Both, Parallel]

Specifies the operation when **Octave** is set to 2–4 octaves.

Up: Notes will repeatedly ascend within the specified range of octaves.

Down: Notes will repeatedly descend within the specified number of octaves.

Both: Notes will repeatedly ascend and descend within the specified number of octaves.

Parallel: The notes of the specified octaves will sound simultaneously.

Fixed Note Mode [Trigger As Played, Trigger All Tones]

When the **Arpeggio Tone Mode** is Fixed Note, specifies the condition that will trigger the Tones.

Trigger As Played: The **Tones** will be triggered according to the number of keys pressed.

Trigger All Tones: Pressing a single key will trigger all **Tones**.

Steps per Beat [x1, x2, x4]

This sets the steps that will swing. The amount of swing is set with the “Swing” parameter in the ARP settings of Scene Setup (found in each Program, Combination or Song), or with RT control knob 4 (SWING). (When the RT control knob 4 (SWING) is “+00”, the swing effect is determined by the value of the “Swing” parameter in Scene settings.)

x1: Swing will be applied to even-numbered steps (2, 4, 6, 8...).

x2: Swing will be applied to steps 3, 7, 11, 15 and numbers following this pattern. For example, when “Resolution” in the Scene 1–4 Setup detailed settings dialog box is set to  and you input an eight-beat rhythm, you’ll get an eight-beat swing effect.

x4: Swing will be applied to steps 5, 13, 21, 29 and numbers following this pattern. For example, when “Resolution” in the Scene 1–4 Setup detailed settings dialog box is set to  and you input an eight-beat rhythm, you’ll get an eight-beat swing effect.

Setup Fixed Note

Opens the Fixed Notes dialog box. Select the notes used when “Arpeggio Tone Mode” is set to “Fixed Note”.

ARP Pattern Edit

 The parameters here will be disabled for preset patterns P0–P4.

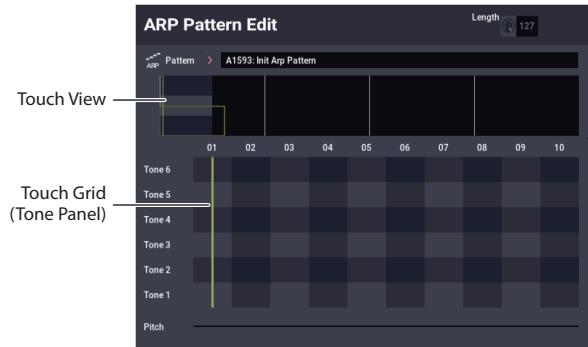

Input Tones 1–12 into steps 01–64. Each “step” can be set up to a length of 64 steps, and up to 12 notes on the keyboard can be played simultaneously per step for a Tone. When “Sort” is selected in the ARP settings of Scene Setup, the Tones will correspond to Tones 1, 2 and so on in the order of the notes that were simultaneously pressed (from low to high). When “Sort” is cleared, the Tones will correspond to Tones 1, 2 in the order that they are pressed.

Touch View

Selects the display area of the Touch Grid.

Touch Grid

Tone Panel

Insert or delete tones by pressing somewhere on the Tone Panel (upper part of the matrix).

Meter [1/4...16/16]

Specifies the beat (time signature) of the arpeggiator pattern.

Step (Step Number) [01...48]

Select the step that you want to edit.

Pitch (Pitch Offset) [-48...+48]

Shifts the pitch of the scale up or down in semitones, corresponding to the Tone for each step. This lets you specify the same Tone for each step and play melodies, or specify multiple Tones for the same step to play parallel chords.

Gate [Off, 001...100%, Legato]

Off: The step in question will not sound, even when a Tone is set. Use this to stop legato parts that sound in previous steps.

Legato: Either the same Tone will be the next to be played (including Gate:Off), or the sound will continue to play until the pattern returns to the beginning.

This setting is enabled when “Gate” in the ARP settings of Scene Setup (found in each Program, Combination or Song) is set to “Step”.

When setting this, make sure that the “Gate” of the mode you are switching from is “Step”.

Velocity [001...127, Key]

Key: The Tones of the steps will sound at the velocity you used when playing the keys.

001–127: The Tones will always sound at the velocity you set. This setting is enabled when “Velocity” in the ARP settings of Scene Setup (found in each Program, Combination or Song) is set to “Step”.

When setting this, make sure that the “Velocity” of the mode you are switching from is “Step”.

Flam [-99...+99]

Sets how the sounds will be distributed when multiple Tones are assigned to the same step.

00: All Tones will sound simultaneously.

+01 to +99: The sounds will be distributed and played in order of their Tone number. (When “Sort” is on, they will play from the lowest note upward; and when “Sort” is off, they will play in the order that the keys were played.)

-01 to -99: The sounds will be distributed in reverse order of that of positive values. You can use positive values for the odd-numbered steps and negative values for the even-numbered steps to simulate strumming chords on a guitar.

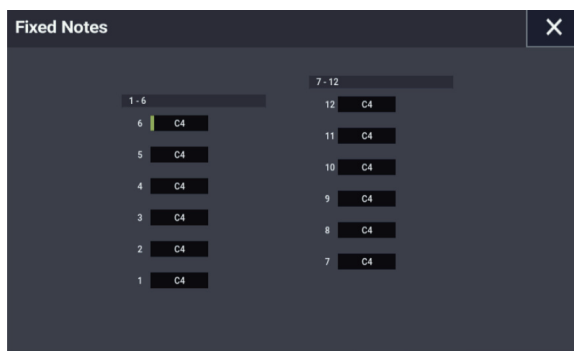
**✓ 6-1: Page Menu Commands**

- Write Arpeggio Patterns →p.693
- Rename Arpeggio Pattern →p.693
- Copy Arpeggio Pattern →p.693

- PAGE →p.126
- MODE →p.126

GLOBAL > Options Info

7-1: Options Info

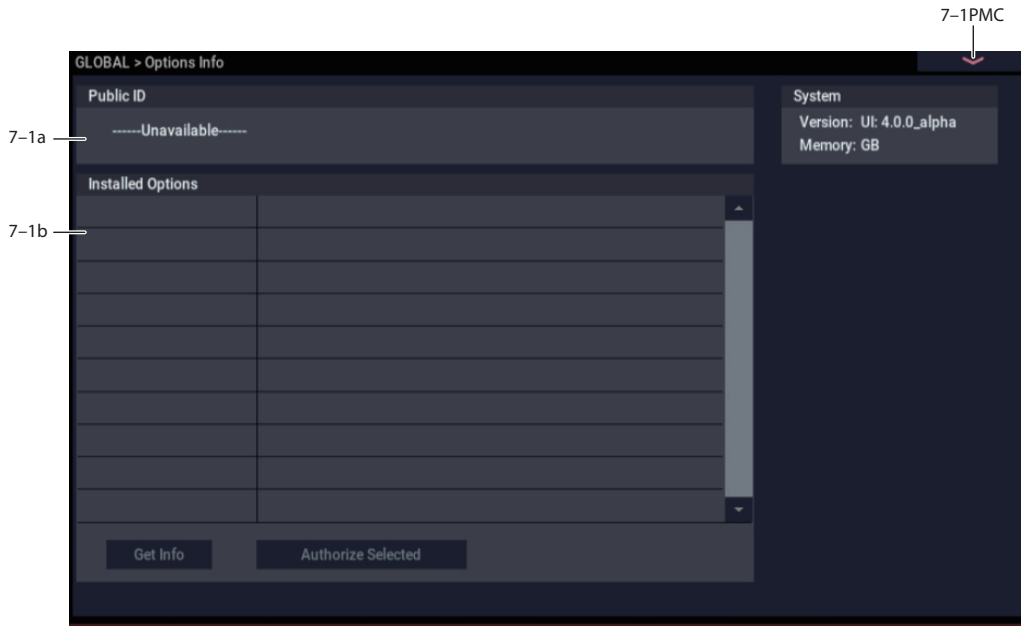

This page lets you manage any installed options. Here, you can:

- View information on all installed options and option bundles
- Authorize options with codes purchased from www.korg.com/NAUTILUS, or from your Korg distributor

7-1a: Public ID

Public ID [nn nn nn nn nn nn nn nn]

This is a unique identifier, like a very specific name; it is different for each and every NAUTILUS. The Public ID is 16 characters long, and uses only the characters 0-9 and A-F. You'll need this ID when registering on www.korg.com, which is required for purchasing options.

7-1b: Installed Options

This section shows all of the installed options or option bundles, and whether they are authorized or in demo mode.

Some options may be bundles which include multiple titles. In this case, the list will show the name of the bundle only. To see all of the titles included in the bundle, select the bundle in the list and press the **Get Info** button.

Demo options are installed on the system, but have not yet been purchased and authorized. When an option is in demo mode, you can play, edit, and save Programs, Combinations, and Songs which use it—but until you purchase and enter an authorization code, any sound which uses the option will fade out periodically. For more information, see “Authorizing options,” below.

Authorized options are fully functional. Some options may already be authorized by default.

Get Info button

Pressing the Get Info button calls up a window containing information for the selected option or option bundle. For instance, it shows all individual titles within an option bundle.

Authorize Selected button

Once you've purchased an authorization code, select the option from the list, and press this button to enter the code into the NAUTILUS. For more information, see “Authorizing options,” below.

Installing EXs

EXs sample data is installed in MEDIA mode. For more information, see “Install EXs” on page 729.

Uninstalling EXs

The **Uninstall EXs** menu command lets you remove optional EXs to reclaim space on the internal drive(s). For more information, see “Uninstall EXs” on page 694.

Authorizing options

Authorizing NAUTILUS options is simple. First, you'll purchase an authorization code; then, you'll enter it on this page. To do so:

1. **Write down the Public ID. Make sure that you've copied it accurately.**
2. **If you have access to the internet, follow the instructions under "Purchasing option licenses via the internet," below.**
or:
If you do not have internet access, follow the instructions under "Purchasing option licenses from your Korg distributor," below.

Purchasing option licenses via the internet

1. **Go to <http://www.korg.com/NAUTILUS>**
2. **Log in under your registered member name.**

If you aren't already registered, follow the online instructions for registering as a member of www.korg.com. After registering as a member, register your NAUTILUS.

3. **Purchase the authorization code for the desired option.**

After purchasing, you'll receive your authorization code. Note that this code is tied to your Public ID, and will not work on other NAUTILUS systems. If you have more than one NAUTILUS, you'll need to purchase authorizations for each one separately.

4. **Once you have the authorization code, follow the instructions under "Authorizing options on the NAUTILUS," below.**

Purchasing option licenses from your Korg distributor

If you do not have access to the internet, your national Korg distributor will be happy to assist you in purchasing option authorization codes.

1. **Write down your NAUTILUS Public ID.**
2. **Contact your Korg distributor, and ask them for assistance with purchasing option authorizations for NAUTILUS.**

You can find contact information for your Korg distributor by contacting your Korg dealer, or from the following page on the Korg website:

<http://www.korg.co.jp/English/index.html>

3. **After you purchase the authorization code(s), proceed to "Authorizing options on the NAUTILUS," below.**

Authorizing options on the NAUTILUS

1. **Go to the Global Options Info page.**
2. **Select the option to authorize from the list of Installed Options.**
3. **Press the Authorize Selected button.**

The Authorize Selected window will appear. You'll see the name of the selected option or option bundle at the top of the window. The window also includes an on-screen keyboard, so that you can enter your authorization code.

4. **Enter the authorization code.**
5. **Press OK.**

Provided that you entered a valid authorization code, the list will now show the option or option bundle as **Authorized**, and the audio limitations of **Demo** mode will be removed.

✓ 7-1: Page Menu Commands

- Write Global Setting →p.686
- Uninstall EXs →p.694
- PAGE →p.126
- MODE →p.126

GLOBAL: Page Menu Commands

| | |
|------------------------------------|--------|
| Compare | →p.112 |
| Write Global Setting | →p.686 |
| Set Program Bank Type | →p.686 |
| Change all bank references | →p.687 |
| Touch Panel Calibration | →p.687 |
| Half Damper Calibration | →p.687 |
| LCD Setup | →p.688 |
| Update System Software | →p.688 |
| Display Public ID | →p.689 |
| Auto Power-Off Setting... | →p.689 |
| Fan Control Setting | →p.689 |
| Rear Panel Illumination Setup | →p.690 |
| Select All | →p.690 |
| Unload all in bank | →p.690 |
| Remap MS/Sample Banks | →p.121 |
| Dump Program | →p.690 |
| Dump Combination | →p.690 |
| Dump Drum Kit | →p.690 |
| Dump Wave Sequence | →p.690 |
| Dump Global Setting | →p.690 |
| Dump Sequencer | →p.690 |
| Dump Set List | →p.690 |
| Dump Drum Track Pattern | →p.690 |
| Dump Arpeggio Pattern | →p.690 |
| System Exclusive Data Dumps | →p.691 |
| Reset Controller MIDI Assign | →p.692 |
| Copy Scale | →p.692 |
| Clear Special Function Assignments | →p.692 |
| Write Wave Sequence | →p.692 |
| Write Drum Kit | →p.693 |
| Copy Key Setup | →p.693 |
| Swap Key Setup | →p.693 |
| Write Arpeggio Patterns | →p.693 |
| Rename Arpeggio Pattern | →p.693 |
| Copy Arpeggio Pattern | →p.693 |
| Uninstall EXs | →p.694 |
| PAGE | →p.126 |
| MODE | →p.126 |

Write Global Setting

This command writes most of the GLOBAL mode settings, with the following exceptions.

- Drum Kits and Wave Sequences are written separately, with their own commands; see “Write Drum Kit” on page 693 and “Write Wave Sequence” on page 692.
- The Effect Global SW settings are not written.

Also, a few settings are saved automatically as soon as they are edited, without need to write the Global Settings, including:

- Auto Power-Off Setting
- Fan Control Setting
- Rear Panel Illumination Setup
- KSC Auto-Load settings

To use the Write Global Setting command:

1. Select Write Global Setting to open the dialog box.

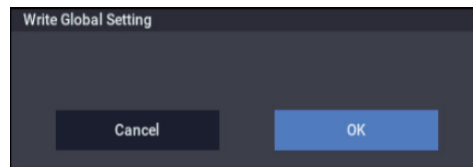

2. To write the data, press the OK button. To cancel without writing, press the Cancel button.

⚠ Do not turn off the power for at least 10 seconds after using the **Write Global Setting** command. This allows the system time to complete the process, which includes saving a backup of the data to the internal drive.

Set Program Bank Type

This command lets you do two related things:

- Set the bank types of each of the Program banks (except for GM) to either HD-1 or EXi
- Initialize banks of Programs

When you execute this command, the Programs within the specified banks will be initialized to Programs of the selected bank type.

Note that bank types are set automatically when loading Program banks from drive; you don’t need to use this command first.

⚠ Before you use this command, make sure that Memory Protect is disabled for Programs (see “0-1e: Memory Protect” on page 635). Otherwise, the message “Memory Protected” will appear after you press OK, and no changes will be made.

1. Choose “Set Program Bank Type” to open the dialog box.

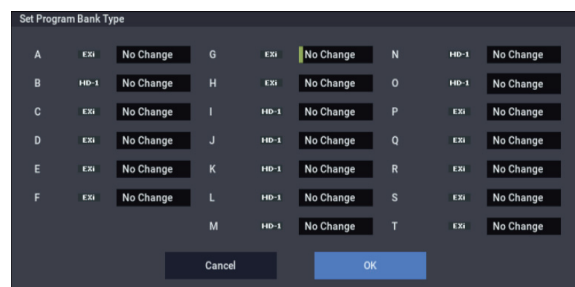

This indicates the current type for each bank.

2. Specify the bank type for each bank.

No Change: The bank type will not be changed, and the bank’s Program data will remain unchanged.

HD-1: The bank type will be set to HD-1, and all of the bank’s Programs will be initialized.

EXi: The bank type will be set to EXi, and all of the bank’s Programs will be initialized.

Note: If a bank is set to anything other than No Change, all data in that bank will be initialized – even if you have specified the same bank type as before. If you want to keep your data, you must first use **Save All** or **Save PCG** to save it.

3. Press the OK button to execute, or press the Cancel button to cancel. A dialog box will ask you to confirm the operation.

4. Verify the settings. Then press the OK button to execute, or press the Cancel button to cancel.

Change all bank references

This command changes all program banks specified for timbres in combinations or tracks of songs.

1. Select “Change all bank references” to open the dialog box.

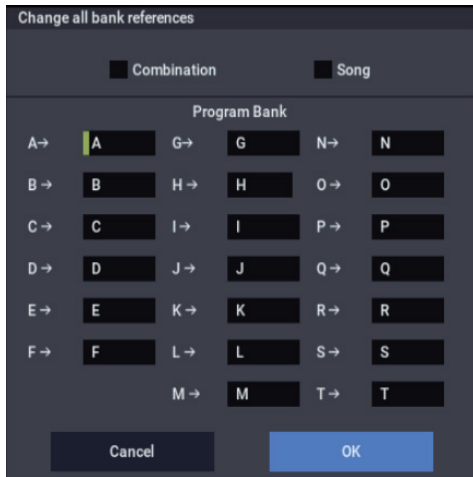

2. If you wish to change bank references for combinations, check “Combination.”
If you wish to change bank references for songs, check Song.
3. In “Program Bank,” specify the replacement for each bank.
4. To execute the Change All Bank References command, press the OK button. To cancel, press the Cancel button.

 If you change two or more different banks to the same bank, it will not be possible to use this function to change them back to different banks. Be careful that the change destination banks do not overlap.

Touch Panel Calibration

If input via the LCD screen does not work as you expect, or if the edit cell moves to a location other than where you pressed the LCD screen, use this command to adjust the sensitivity of the LCD screen.

1. Select “Touch Panel Calibration” to open the dialog box.

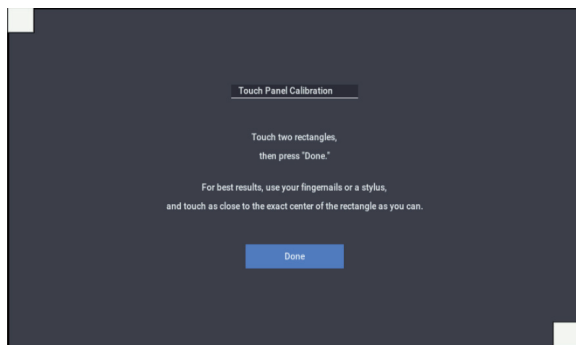

2. If you are unable to select this command from the page menu, go to the Basic Setup page, and then hold

down the ENTER button and press QUICK ACCESS D button. This will call up the calibration dialog.

3. Press the square in the upper left of the LCD. When your touch has been detected correctly the square will be highlighted.
4. Press the square in the lower right of the LCD. When your touch has been detected correctly the square will be highlighted.
5. Press the Done button.

If your touch was not detected correctly, an error message will appear. Please perform the procedure once again.

Half Damper Calibration

If a damper pedal that supports half damper (the DS-1H option) is connected to the DAMPER jack, here’s how you can adjust the sensitivity if the damper effect is not applied appropriately.

 Since the half-damper pedal is highly sensitive, please use the optional DS-1H. Other pedals may not produce the appropriate effect, or may be impossible to calibrate correctly.

1. Connect a half-damper pedal to the DAMPER jack.
2. Select “Half Damper Calibration” to open the dialog box.

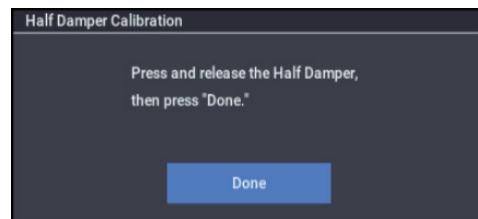

3. Press the half-damper pedal, and then release your foot from the pedal.
4. Press the Done button.

If the adjustment could not be performed correctly, an error message will be displayed. Please perform the procedure once again.

LCD Setup

This lets you adjust the brightness of the LCD screen.

1. Choose LCD Setup to open the dialog box.

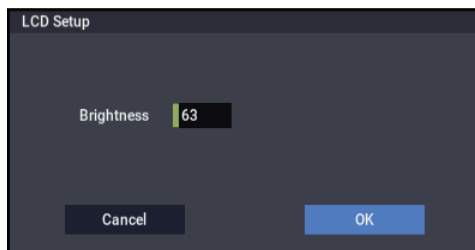

2. Adjust the Brightness as desired.
Brightness: 0...63 (63 is the default)
Adjusts the brightness of the display's backlight.
3. To finish the LCD Setup, press the OK button. To cancel without making changes, press the Cancel button.

Update System Software

Before you start the update process, back up important data on external USB storage media.

1. Using a computer, download the update from the Korg website: www.korg.com/NAUTILUS.

The update will be in compressed, zip format.

2. Un-zip the downloaded file.

Un-zipping will result in a folder containing several different files and at least one sub-folder, with names such as:

```
install.info
mnt (folder)
posttar.sh
pretar.sh
Update[number].tar.gz
```

Files may have different names, and there may also be additional files. Note that some file names may end with "tar.gz" or "tgz;" this is normal, and these files are ready for use by the installer without need for further un-zipping.

Note: Depending on your browser settings, the downloaded file may be unzipped automatically, creating the files and folders described above.

3. Follow any instructions included with the update.
4. Open the folder from step 2, above.
5. From within this folder, copy all of the files and sub-folder(s) to the root level of a FAT32-formatted USB storage device, such as a USB flash drive.

Copy the files and sub-folders only; don't copy the main, enclosing folder.

FAT32 format is required. Other formats, including NTFS (Windows) or HFS+ (Mac OS X), will not work. Most USB flash drives use FAT32 by default.

6. Disconnect all USB devices from the NAUTILUS.

Other USB devices may interfere with the update process.

7. Go to the GLOBAL > Basic Setup page.

To go to this page from any part of the system, press the GLOBAL button to enter GLOBAL mode, and press the EXIT switch up to four times. (This always takes you to the first page of the selected mode.)

8. Open the menu, and select the command "Update System Software."

A dialog will appear on the screen:

Connect the Software Update media, and press OK.

9. Connect the USB storage device containing the update file(s), from step 5 above.

10. Press the OK button.

A window will appear with the message "Searching for update files..."

If a valid update file is found, a new dialog will appear:

Found version [version number] updater files

Press OK to install

11. Press the OK button again.

A message and progress bar will appear on the screen, noting that the system is being updated.

Do not disconnect the USB storage device while the update is in progress.

While the system is being updated, do not touch the NAUTILUS' switches, and never turn off the power. If the power is accidentally turned off while the system is being loaded, the NAUTILUS may become inoperable. If this occurs, using the Restore DVDs may be required; please contact your local Korg distributor.

When the update is complete, a new message will appear:

Update to NAUTILUS system version [nn] complete.
Please turn off the power, wait a moment, and then turn on power again to use the new software.

12. Turn off the NAUTILUS, and then disconnect the USB storage device.

13. Wait approximately ten seconds, and then turn the power on again.

The system version number is shown on the startup screen, and also on the GLOBAL > Options Info page. Verify that it is correct.

Error messages

If any problems occur, an error message will appear:

Error: the system update was not successful

If you see this error or encounter other difficulties, try the following:

- Make sure that all other USB devices are disconnected
- Make sure that you have copied all the files and sub-folders included with the update, as described in step 5 above
- Use a different, freshly-formatted USB storage device

Display Public ID

The Public ID is a unique identifier, like a very specific name; it is different for each and every NAUTILUS. It's 16 characters long (not counting the dashes between each pair of characters), and uses only the characters 0-9 and A-F.

You'll need to know the instrument's Public ID when purchasing NAUTILUS software options, or if you have to re-authorize the NAUTILUS software.

This simple dialog displays the instrument's Public ID.

1. Select **Display Public ID** to open the dialog box.
2. Write down the 16-character Public ID, as displayed on the screen.
3. Press **OK** to close the dialog box.

Auto Power-Off Setting...

This menu command appears only on NAUTILUS models which support the Auto Power-Off feature. These models can be set to automatically turn off the power when the system has not been active for a certain length of time. "Activity" includes using the TouchView display and most front panel controls, playing sounds, sending or receiving MIDI, local or ftp drive activity, etc. It *does not* include usage of the MASTER VOLUME slider, however.

 When the power turns off, any un-saved edits or settings will be lost. Make sure that you save important settings before this occurs.

You can control the amount of time before the system turns off, or disable Auto Power-Off entirely. To do so:

1. In the menu, select the **Auto Power Off Setting...** command.

The dialog box below will appear.

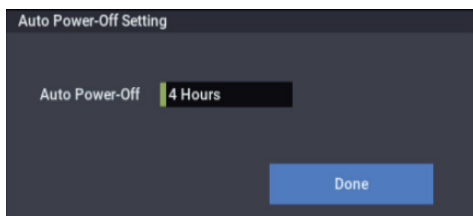

2. Press the "Auto Power-Off" popup button to select the length of idle time after which the power will turn off. If you don't want the power to turn off automatically, set this to **Disabled**.

4 hours is the default.

You can also reach this dialog box from the two warning dialogs associated with Auto Power-Off, as described below.

Changing the Auto Power-Off setting at startup

If Auto Power-Off is enabled, a dialog box indicating the time until automatic power-off will appear immediately after start-up.

This dialog box is shown for several seconds, and then automatically closes. The clock shown in the dialog box shows the time left before the dialog box closes. Press the clock to pause the time and keep the dialog box open. Press the Change Setting or OK button to close this dialog box, or simply wait for the clock to run out.

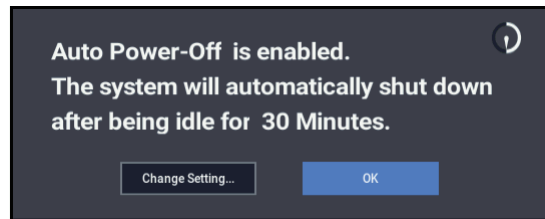

1. To change the auto power-off setting, press the **Change Setting** button.

The **Auto Power-Off Setting** dialog box will appear, just as if you'd selected the Global menu command described above.

Auto Power-Off warning message

When the specified length of time has elapsed without any user input on the NAUTILUS, a message will appear, warning you that the Auto Power-Off function is about to turn off the power.

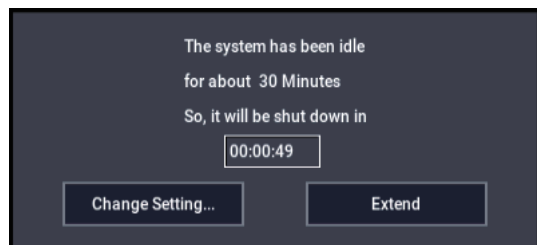

If you want to continue using the system, press the keyboard, a button, or some part of the display such as the Extend button. The Auto Power-Off function will be reset. If the specified length of time again elapses with no user input, the same message will appear again. You can also use the Change Setting button to bring up the **Auto Power-Off Setting** dialog, as described above.

Fan Control Setting

This allows you to control the system's fan, and to check the internal temperature.

1. Select the **Fan Control Setting** command to open the dialog box.

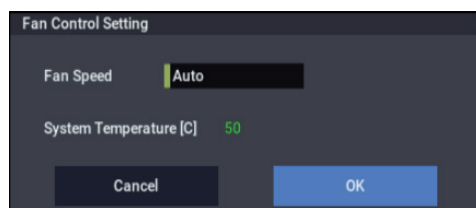

2. Set the **Fan Speed** as desired.

Auto is the default; the system will control the fan based on the temperature of the system.

Use **Off** to minimize the operating noise of the fan. Please note that you should use this setting only temporarily, and not routinely. If **Fan Speed** is set to **Off**, take care that the **System Temperature** shown on-screen does not exceed 80°C. If the temperature exceeds 80°C, the fan will turn on regardless of the **Fan Speed** setting, and continue until the system has cooled sufficiently.

On KRONOS units from 2013 or earlier, and on the KRONOS X, **Slow** is available instead of **Off**. With this setting the fan will move slowly, but will not stop

completely. If the temperature exceeds 89°C, the fan will switch to a higher speed regardless of the **Fan Speed** setting, and continue until the system has cooled sufficiently.

Rear Panel Illumination Setup

The Korg logo on the rear panel includes an LED for illumination. This command lets you turn the LED on or off, as you wish.

1. **Select the Rear Panel Illumination Setup command to open the dialog box.**
2. **Turn on the checkbox if you want the LED to be lit; turn it off if you want the LED to be unlit.**
1. **Press the OK button to confirm, or press the Cancel button to cancel without making a change.**

Select All

This selects all items in the list.

Unload all in bank

This command lets you un-load an entire bank of sample data at once. To do so:

1. **In the menu, select the Unload all in bank command.**
The **Unload all data from selected bank** dialog will appear.
2. **Select the desired bank (SAMPLING Mode, or any EXs or User Sample Bank).**
3. **Press the OK button to confirm, or Cancel to exit the dialog without making changes.**

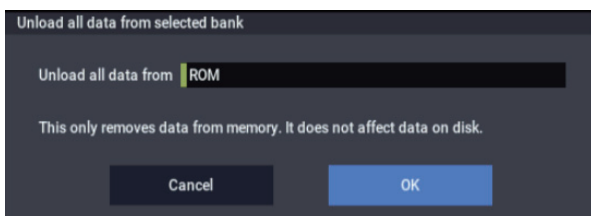

Dump Program

This command lets you send the internal memory's Program data as a System Exclusive data dump. You can choose to send all of the Programs from all of the banks, all of the Programs from a single bank, or a single Program.

For more information, see "System Exclusive Data Dumps" on page 691.

Dump Combination

This command lets you send the internal memory's Combination data as a System Exclusive data dump. You can choose to send all of the Combinations from all of the banks, all of the Combinations from a single bank, or a single Combination.

For more information, see "System Exclusive Data Dumps" on page 691.

Dump Drum Kit

This command lets you send the internal memory's Drum Kit data as a System Exclusive data dump. You can choose to send all of the Drum Kits from all of the banks, all of the Drum Kits from a single bank, or a single Drum Kit.

For more information, see "System Exclusive Data Dumps" on page 691.

Dump Wave Sequence

This command lets you send the internal memory's Wave Sequence data as a System Exclusive data dump. You can choose to send all of the Wave Sequences from all of the banks, all of the Wave Sequences from a single bank, or a single Wave Sequence.

For more information, see "System Exclusive Data Dumps" on page 691.

Dump Global Setting

This command lets you send the internal memory's Global Settings data as a System Exclusive data dump. For more information, see "System Exclusive Data Dumps" on page 691.

Dump Sequencer

This command lets you send the internal memory's Sequencer data, including all Songs in memory, as a System Exclusive data dump.

For more information, see "System Exclusive Data Dumps" on page 691.

Dump Set List

This command lets you send the internal memory's Set List data as a System Exclusive data dump. You can choose to send either all of the Set Lists, or a single Set List.

For more information, see "System Exclusive Data Dumps" on page 691.

Dump Drum Track Pattern

This command lets you send the internal memory's Drum Track User Pattern data as a System Exclusive data dump. You can choose to send either all of the Patterns, or a single Pattern.

For more information, see "System Exclusive Data Dumps" on page 691.

Dump Arpeggio Pattern

This command lets you send the internal memory's Arpeggio Pattern data as a System Exclusive data dump. For more information, see "System Exclusive Data Dumps," below.

System Exclusive Data Dumps

These commands allow the NAUTILUS internal data to be transmitted to another NAUTILUS, MIDI data filter, or computer in the form of MIDI System Exclusive data.

System Exclusive dump types

| | |
|------------------------------|---|
| Dump Program | All Programs, a specific bank of Programs, or a single Program |
| Dump Combination | All Combinations, a specific bank of Combinations, or a single Combination |
| Dump Drum Kit | All Drum Kits, a specific bank of Drum Kits, or a single Drum Kit |
| Dump Wave Sequence | All Wave Sequences, a specific bank of Wave Sequences, or a single Wave Sequence |
| Dump Global Settings | Global settings (except for Drum Kits and Wave Sequences) |
| Dump Sequencer | All Song and Region data |
| Dump Set List | All Set Lists, or a single Set List |
| Dump Drum Track User Pattern | All Patterns, or a single Pattern |
| Dump Arpeggio Pattern | All: Data dump of all user arpeggio patterns Bank: Individual data dumps for bank A and B separately Single: Data dump for a single pattern |

Sending SysEx data dumps

Do not touch the NAUTILUS’s switches or turn off the power while data is being transmitted.

1. Connect the NAUTILUS to the device that will receive the data dump.

If you’re using a computer editor, connect the NAUTILUS USB B port to one of the computer’s USB ports. You may need to wait briefly for the connection to be recognized.

Alternatively, if you’re using a computer with a MIDI interface, connect the MIDI IN connector of your computer’s MIDI interface to the NAUTILUS MIDI OUT connector. Note that this will be much slower than using USB, as described above.

If you are using a MIDI data filer, connect the NAUTILUS’s MIDI OUT connector to the MIDI IN connector of the MIDI data filer.

- 2. Go to GLOBAL > MIDI.**
- 3. Select the desired “dump” command from the menu (see the table “System Exclusive dump types,” above).**
- 4. Select the specific data to send. For example, all of that type, a single bank, or a single item.**

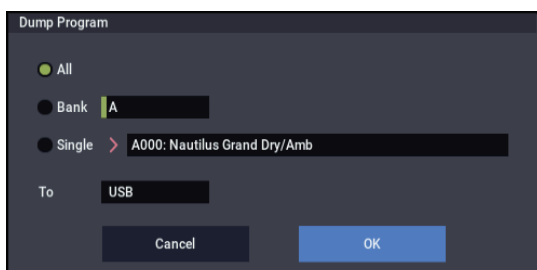

5. Select whether to send the dump via MIDI OUT or USB.

When using a computer, choose USB if possible.

6. Press the OK button to transmit the data.

While the data is being transmitted, the display will indicate “Now Transmitting MIDI Data.”

The size of the data and the time required for transmission will depend on the type of data.

When performing a data dump from the NAUTILUS onto a MIDI data filer, do not transmit multiple data dumps together. If multiple data is saved together, the NAUTILUS will have less than the required time to write the data into memory, and will be unable to receive all of the data correctly.

Receiving SysEx data dumps

1. Connect the NAUTILUS to the device which will send the data dump.

If you are using a computer, connect the USB B port of the NAUTILUS to one of the computer’s USB ports.

If you are using a MIDI data filer, connect the data filer’s MIDI OUT to the NAUTILUS’s MIDI IN.

2. Set the NAUTILUS’s global MIDI channel to match the channel used for the data dump.

When the NAUTILUS sends a SysEx dump, the current global MIDI channel is embedded in the data. In order to receive the data, the NAUTILUS’s global MIDI channel must be set so that it was the same as when the data was transmitted.

3. Turn on the “Enable Exclusive” check-box in the MIDI Filter section of the GLOBAL > MIDI page.

4. Transmit the data from the other device. For the procedure, refer to the owner’s manual for the device you are using.

While the data is being received, the display will show the message “Now receiving MIDI data.”

Do not touch the NAUTILUS’s switches or turn off the power while data is being received.

Before receiving MIDI data, we recommend that you close any open dialog box or menu, with the exception of the Disk page menu command **Save Exclusive (Receive and Save MIDI System Exclusive Data)** dialog box.

After a data dump is received, the NAUTILUS will require approximately one second to process the data and write it into memory. During this time, the display will show the message, “Now writing into internal memory.” While this message is shown, you must under no circumstances turn off the power of the NAUTILUS. If the power is turned off during this time, the NAUTILUS may fail to operate correctly when the power is turned on again.

Transmission and reception of MIDI data is also impossible during this time. When receiving multiple data dumps in succession, you must allow enough time between each data dump for the message to disappear from the screen.

MIDI cannot be transmitted or received while data is being written into internal memory. Also, transmission of Active Sensing (FEh) from the MIDI OUT connector and USB connector will be halted.

Cautions when receiving Program data

- When receiving a data dump for a bank or a single program, and the bank type of the received program is different, the message “Program Bank Type Conflicts” will appear, and the data will not be received. To resolve this, use the Global menu command **Set Program Bank Type** to specify the appropriate bank, and then send the data again. (See “Set Program Bank Type” on page 686.)
- When receiving an All Programs data dump, only bank data whose bank type matches will be received. If banks of a different bank type are received, the message “Program Bank Type Conflicts” will be displayed.

Reset Controller MIDI Assign

This automatically sets the MIDI CC# Assign– Controllers on the Controllers/Scales– Controllers page.

5. Choose “Reset Controller MIDI Assign” to open the dialog box.

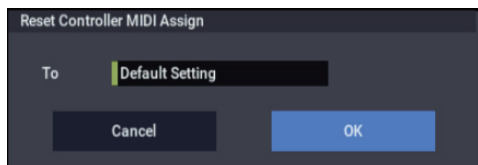

6. Set the “To” field to the desired reset method.

All Off: All settings will be Off.

Default Setting: The ARP/DRUM controls and pads will all be set to Off; the X-Y Control will be set to its default CCs.

CC Default: This sets up the recommended CCs for the pads and ARP/DRUM controls, as well as the X-Y Control. The default values are shown in the table below.

If you want to record ARP/DRUM controllers in SEQUENCER mode, or use the controllers with external MIDI devices, we recommend using this setting.

(You are also free to assign different MIDI CCs to the controllers, if you wish.)

7. Press the OK button to execute the reset command, or press the Cancel button to cancel.

Reset Controller MIDI Assign Default

| | | Default Setting | CC Default |
|-------------|----------|-----------------|------------|
| ARP/DRUM | LATCH | Off | (CC#31) |
| | ARP | Off | (CC#14) |
| | DRUM | Off | (CC#15) |
| | GATE | Off | (CC#22) |
| | VELOCITY | Off | (CC#23) |
| | LENGTH | Off | (CC#24) |
| | SWING | Off | (CC#25) |
| X-Y Control | DRUM SD | Off | (CC#26) |
| | XY X | (CC#118) | (CC#118) |
| | XY Y | (CC#119) | (CC#119) |

Copy Scale

This command copies data from a preset scale or between user scales. For details on the preset scales, see “1–1e: Scale” on page 38.

1. Select “Copy Scale” to open the dialog box.

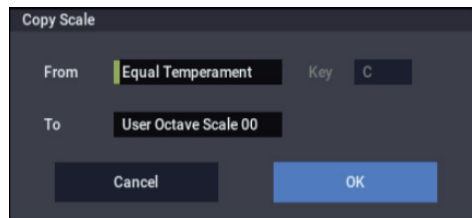

2. Use “From” to select the copy-source scale.

If you select Pure Major or Pure Minor, specify the “Key” (located at the right) as well.

Stretch cannot be selected if “To” is User All Notes Scale.

3. In “To,” selects the copy destination scale.

4. To execute the Copy Scale command, press the OK button. To cancel, press the Cancel button.

Clear Special Function Assignments

This command appears on the Function Assign page. It resets all of the assignments to the default values: MIDI Channel = Gch, and CC = Off.

Write Wave Sequence

A dialog box for saving a wave sequence will appear. You can select a new location, and edit the name of the wave sequence.

You must write an edited wave sequence if you want to keep it. An edited wave sequence cannot be recovered if you turn off the power or select a different wave sequence before writing it.

1. Choose “Write Wave Sequence” to open the dialog box.

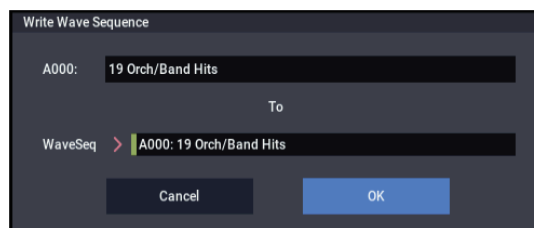

2. The upper line shows the Wave Sequence name. To edit the name, press the text edit button to open the text edit dialog box, and set the name as desired (up to 24 characters).

If a USB QWERTY keyboard (commercially available) is connected, you can use this to enter text instead of the on-screen keyboard. For more information, see “Editing names and entering text” on page 206 of the OG.

3. Use the lower line “To Wave Sequence” to select the writing-destination.

You can also press the popup button and choose the writing-destination from the “Wave Sequence Select” menu. If you select the “Wave Sequence Select” menu,

press the OK button to confirm or press the Cancel button to cancel your selection.

4. **Press the OK button to execute the Write Wave Sequence command, or press the Cancel button to cancel without executing.**

 Do not turn off the power for at least 10 seconds after using the **Write Wave Sequence** command. This allows the system time to complete the process, which includes saving a backup of the data to the internal drive.

Write Drum Kit

This command writes an edited drum kit into internal memory.

You must write an edited drum kit if you want to keep it. An edited drum kit cannot be recovered if you turn off the power or select a different drum kit before writing it.

1. **Choose “Write Drum Kit” to open the dialog box.**

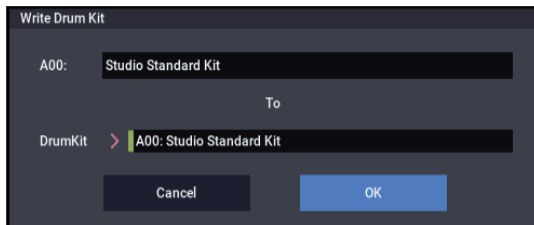

2. **The upper line shows the drum kit name. To edit the name, press the text edit button to open the text edit dialog box, and set the name as desired (up to 24 characters).**

If a USB QWERTY keyboard (commercially available) is connected, you can use this to enter text instead of the on-screen keyboard. For more information, see “Editing names and entering text” on page 206 of the OG.

3. **Use the lower line “To Drum Kit” to select the writing-destination.**

You can also press the popup button and choose the writing-destination from the “Drum Kit Select” menu. If you select the “Drum Kit Select” menu, press the OK button to confirm or press the Cancel button to cancel your selection.

Note: You can’t write to GM0 through GM8. If you’ve edited one of the GM drum kits, you may write it to the A00...O15 banks.

4. **Press the OK button to execute the Write Drum Kit command, or press the Cancel button to cancel without executing.**

 Do not turn off the power for at least 10 seconds after using the **Write Drum Kit** command. This allows the system time to complete the process, which includes saving a backup of the data to the internal drive.

Copy Key Setup

This command copies the Drum Sample assignments and other settings from one Drum Kit key to another. You can also copy settings from two or more contiguous keys at once.

1. **Select Copy Key Setup to open the dialog box.**



2. **In “From Key,” select the range of keys that you wish to copy.**
3. **In “To Key,” select the copy destination key. If two or more keys are selected in “From Key,” their settings will be copied to the keys starting at “To Key” and continuing upward.**
4. **To execute the Copy Key Setup command, press the OK button. To cancel, press the Cancel button.**

Swap Key Setup

This command exchanges (swaps) the Drum Sample assignments and other settings between two keys in a Drum Kit.

1. **Choose Swap Key Setup to open the dialog box.**

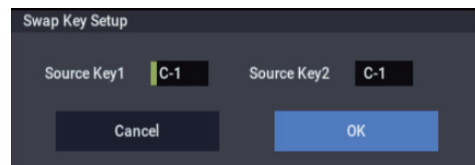

2. **Use “Source1” and “Source2” to specify the keys whose settings you want to swap.**
3. **Press the OK button to execute the Swap Key Setup command, or press the Cancel button to cancel.**

Write Arpeggio Patterns

This writes all user arpeggio patterns in the ranges A0000–A2047 and B000–B127.

Rename Arpeggio Pattern

This renames the selected user arpeggio pattern. You can enter up to 24 characters. You can also change the category and sub-category for the arpeggio pattern here.

Preset patterns P0–P4 cannot be renamed.

Copy Arpeggio Pattern

This copies the settings from a different user arpeggio pattern to the currently selected arpeggio pattern. You cannot copy from preset arpeggio patterns P0–P4.

Use “From” to select the arpeggio pattern of the copy source.

- ⚠ Be careful when executing the “Copy Arpeggio Pattern” command, as the settings of the currently selected arpeggio pattern will be overwritten.

Uninstall EXs

Optional EXs may be uninstalled to reclaim space on the internal drive(s). To do so:

1. Go to the Options Info page.
2. In the list of Installed Options, select the EXs that you'd like to remove.
3. Select the Uninstall EXs command from the menu.

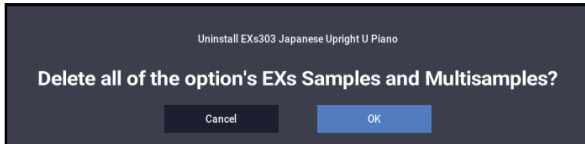

A dialog box will appear:

Uninstall [EXs name and number]
Delete all of the option's EXs Samples and
Multisamples?

4. Press OK to continue.

Another dialog box will appear, showing that the uninstall is in progress. After the uninstall is complete, a third dialog box will appear:

[EXs name and number] sample data deleted.
Related PCG, KSC etc. may remain; delete manually if
desired.

Only the EXs Multisamples and Drum Samples are removed from the drive. KSC and PCG files can be edited, and so they might contain your personal data; to avoid inadvertently affecting your data, these files are left untouched.

5. Press OK to continue.
6. If you like, delete the related PCG and KSC files manually in MEDIA mode.

- ⚠ Uninstall is available only for optional EXs10 and above. It does not apply to EXs1 through 9.
- ⚠ After uninstalling, any sounds which used the uninstalled EXs will no longer play correctly.

MEDIA mode

MEDIA mode is where you can save data from internal memory to the internal drive or an external USB storage device, or load data from media into internal memory. You can also copy or delete files, or format media.

In addition to the internal drive, NAUTILUS supports most USB storage devices, including:

- Hard disk drives
- Removable disk drives
- USB flash media
- CD-R/RW drives

With external drives and flash media, the NAUTILUS supports MS-DOS FAT16 and FAT32 disk formats. FAT 16 supports up to 4 GB; FAT 32 supports up to 2 Terabytes (2,000 GB).

CD-R/RW

The NAUTILUS can read and write UDF format CD-R/RW disks. For more information, see “CD-R/RW disks on the NAUTILUS: UDF and packet-writing” on page 948.

DVD-ROM

The NAUTILUS can read (but not write) UDF format DVD-ROM disks.

Files, directories, and icons

The NAUTILUS manages data on drive and other media in a hierarchical manner, using files and directories. The contents of a file (whether it is a file or a directory) are indicated not only by the name but also graphically by an icon. Files and directories have differently shaped icons.

The NAUTILUS collectively refers to files and directories recognizable by MS-DOS (readable by a MS-DOS computer), and UDF format and ISO9660 format files and directories as “DOS files” and “DOS directories.” Different types of DOS file are distinguished by the extension added to their filename.

In the case of a DOS file with an extension other than listed below, selecting “Load selected” to open the dialog box will cause the file to be considered to be a Standard MIDI File (SMF). However, in this case non-SMF files cannot be loaded

File extensions and NAUTILUS data types.

| Extension | Type |
|-----------|--|
| .PCG | Program, combination, drum kit, wave sequence, global settings (NAUTILUS format) |
| .SNG | Songs and regions (NAUTILUS format) |
| .MID | Standard MIDI File (SMF) |
| .EXL | MIDI System Exclusive data |
| .KMP | Korg Multisample Parameter file Songs and regions (NAUTILUS format) |
| .KSF | Korg Sample File (Korg format) |
| .KSC | Korg Sample Collection file (Korg format) |
| .AIF | AIFF file |
| .WAV | WAVE file |
| .SYX | DX-format System Exclusive files |
| .KFX | Effect preset (NAUTILUS format) |
| .exsins | EXs installer file |

When NAUTILUS data is saved, one of these filename extensions will be added automatically, according to the type of data. If these filename extensions are modified on a computer, the file will be treated as an undefined file when it is reloaded back into the NAUTILUS, and will be handled as a Standard MIDI File.

The diagram on the next page shows how the NAUTILUS handles files.

Since .PCG, .SNG, .KSC, and .KFX files can be opened to divide their contents, they are displayed as directory icons. Different colors are used to indicate different types of file.

Files available in MEDIA mode

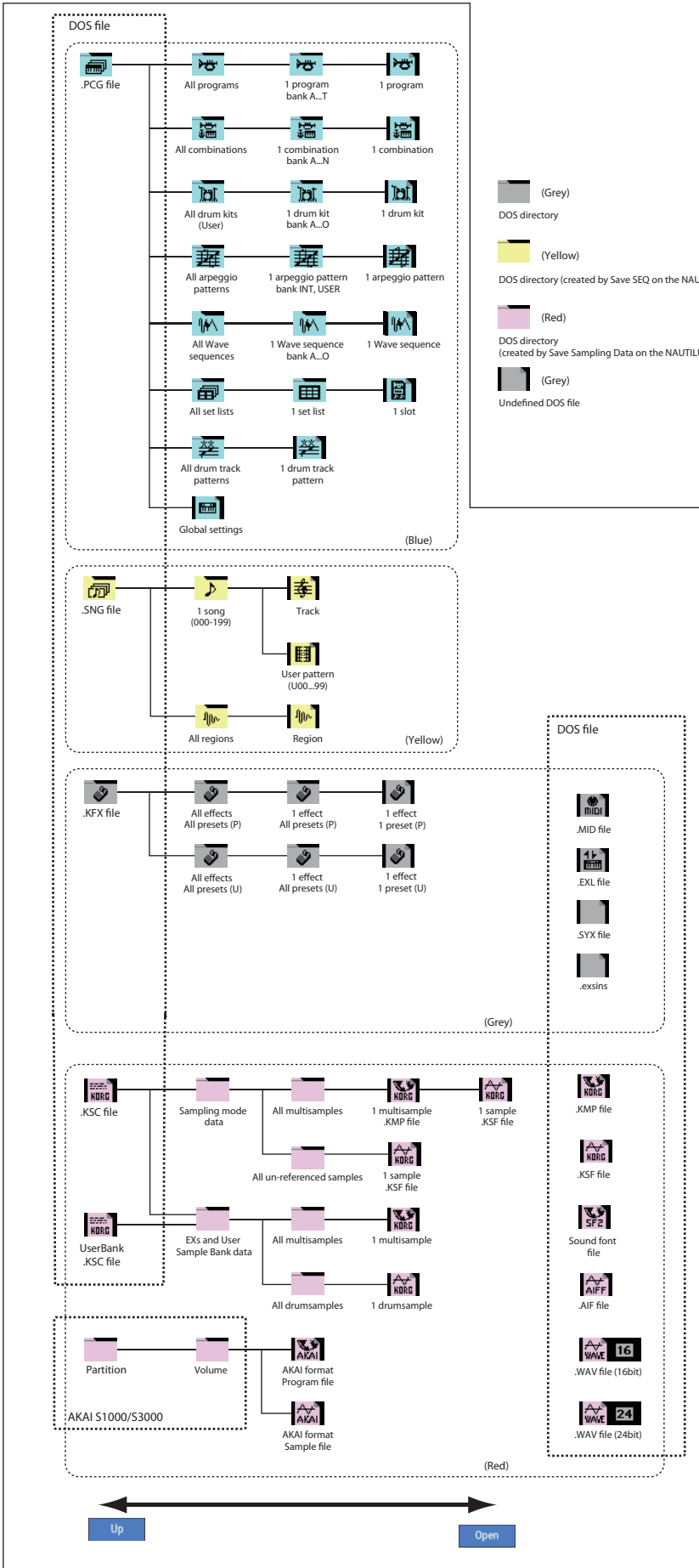

MEDIA

0-1: Load



This page lets you load a selected file or directory into internal memory. Use the Open and Up buttons to select the desired file or directory, and press the Load button to load it. You can also load data by using the **Load selected** page menu command.

Auditioning sounds from disk

Whenever you've selected an individual Program, Combination, Drum Kit, or Wave Sequence from within a PCG file, you can play it from the keyboard immediately—no need to load it into memory!

To do this:

1. Select a PCG file on the disk.
2. Use the OPEN button to open the PCG file, so that you can see its contents.
3. Continue to use the OPEN button to navigate through the folders, until you've can see the name of the sound you'd like to audition.
4. Touch the name of the sound.
5. Play the sound from the keyboard.

When auditioning a Combination, the Timbres will use the Programs currently loaded into internal memory—which may be different from the Programs stored in the PCG file.

Auditioning Drum Kits and Wave Sequences

When auditioning Drum Kits or Wave Sequences, you'll hear them as if they were being played through the parameter settings of the previously selected Program or Combination. This includes filter settings, envelopes, etc. So, before you start auditioning sounds, it's best to first select a suitable sound in PROGRAM mode, and then return to MEDIA mode.

Auditioning sounds which use non-ROM samples

When auditioning sounds from disks, the system can only use Samples and Multisamples which are already loaded. If a Program, Drum Kit, or Wave Sequence uses SAMPLING mode, EXs, or User Sample Bank data which is not loaded, it will not sound correct when auditioned from disk.

Auditioning WAVE files

You can also audition 44.1kHz and 48kHz WAVE files directly from disk. For more information, see "Play (WAVE Preview)" on page 698.

0-1a: Drive Select, Command buttons

Drive Select

[HDD:INTERNAL HD, CDD, HDD, RDD: name]

Selects the device (hard disk, CD, etc.) that you will use for loading/saving.

The volume label assigned to the media will be displayed.

Drive types

HDD: INTERNAL HD: internal drive.

CDD: USB CD-ROM or CD-R/RW drive

HDD: USB hard disk drive

RDD: Removable media such as flash media readers or MO (Magneto-Optical) drives

Volume label

No Label: Media that has no volume label

Unformatted: Media that has not been formatted

No Disc: Media is not inserted in the CD-ROM or CD-R/RW drive

No Media: Media is not inserted in the removable media drive (other than a CD-ROM or CD-R/RW drive)

The volume label display of a CD-R/RW drive will depend on the inserted media and the page.

Blank Disc: Blank media. (If you want to use this disc as a packet-writing-compatible disc, you must format it.)

Media volume label: Media that contains data

Multiple Select MultipleSelect [Off, On]

If this is checked, you will be able to select more than one file or directory. The check mark will turn on or off each time you press it, enabling or disabling multiple selection. Use this when you want to load or copy multiple files in a single operation.

Note: When **Multiple Select** is On, the **Open** and **Up** buttons are disabled.

Open

When you press the Open button, the directory will open, and the current directory will move one level downward.

This can be used when a directory has been selected in the directory window.

Note: When **Multiple Select** is On, the **Open** and **Up** buttons are disabled.

Up

When you press the Up button, the directory will move one level upward.

Sort Sort [Off, On]

This function sorts the files in the current directory.

Press the button to open the dialog box, and use the radio buttons to select the sorting method. Then press the OK button to execute.

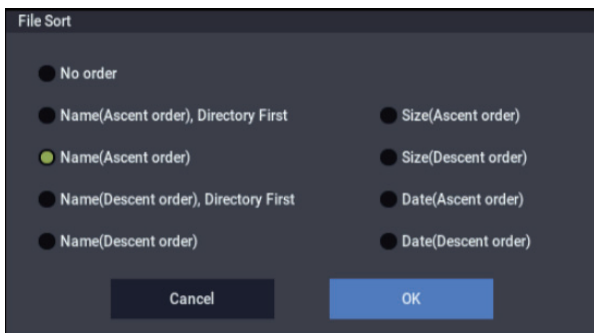

Choose one of the following sorting orders.

No order: Unsorted

Name (Ascending order), Directories First: Sort in alphabetical order, first directories and then files

Name (Ascending order): Sort alphabetically

Name (Descending order), Directories First: Sort in reverse alphabetical order, first directories and then files

Name (Descending order): Sort in reverse alphabetical

Size (Ascending order): Sort in ascending order of size

Size (Descending order): Sort in descending order of size

Date (Ascending order): Sort in ascending order of date

Date (Descending order): Sort in descending order of date

PCG Preview

By selecting a single .PCG file for a Program, Combination, drum kit or wave sequence (for which the bank is open) in the directory window and then playing the keyboard, you can listen to the media directly without loading it. The sound will likely not play correctly if you have not loaded the relevant RAM or EXi samples.

For Combinations, the Programs for the timbre in use will be used on the Program of the NAUTILUS. Drum kits and wave sequences will play using the sound parameters of the Program selected before entering MEDIA mode.

Play (WAVE Preview)

In the Load, Save, and Utility pages and dialog boxes, you can audition WAVE files directly from the disk.

When you select a WAVE file, the PLAY button will become active; simply press it to hear the file. You can also use the front-panel SAMPLING START/STOP button.

Note: This is available only for 44.1kHz and 48kHz files.

Load

This loads the selected file or directory into internal memory.

When you press the Load button, a dialog box will appear. The specific contents of the dialog box will depend on the file you are loading. This is the same as the **Load selected** page menu command.

For more information, see “Load selected” on page 703.

Install

EXs installer files have the suffix .exsins. When one of these files is selected, the **Load** button will change to read **Install**. Pressing this button is the same as using the **Install EXs** menu command on the MEDIA > Utility page.

Note that only one EXs can be installed at a time. If **Multiple Select** is On, **Install** will be disabled.

For more information, see “Install EXs” on page 729.

0-1b: Current Directory

Current Directory

The directory currently selected for processing is referred to as the “current directory.”

The LCD screen will show the full path name of the directory. A slash “/” character is used as the delimiter between directory levels. To change the current directory, use the Open button and Up button (0-1a).

0-1c: Directory Window

This shows file information for the current directory. You can select a file or directory in this window.

Type

This icon indicates the type of file.

For details on how the icons correspond to the different file types, refer to the diagram “Files available in MEDIA mode” on page 696.

Lock [Off, On]

Files and directories with this symbol are locked, and cannot be overwritten, copied, or deleted. Use the “Lock/Unlock” page menu command to lock or unlock a file or directory.

File

When the menu command **Translation** is off (not checked), Multisample (.KMP) and Sample (.KSF) files will be shown with their low-level DOS file names—for example, “TROMB073.KMP.”

When **Translation** is on (checked), you’ll see the full 16-character Multisample and Sample names, as shown elsewhere in the system—for example, “Trombone Section.”

Size

This is the size of the file, in bytes.

Date

This is the date and time at which the file was saved. From the left, this is the year, month, day, hour, minute, and second.

To set the current date and time for the NAUTILUS system, use the Utility page menu command **Set Date/Time**. For more information, see “Set Date/Time” on page 727.

✓ 0-1: Page Menu Commands

- Hide unknown files →p.703
- Translation →p.703
- Show L/R as Stereo Pair →p.703
- Lock/Unlock selected →p.703
- Load selected →p.703
- Load PCG (RAM) and Samples →p.719

- PAGE →p.126
- MODE →p.126

0-2: Save



Here you can save data from internal memory to internal or external disks, CD-R/RW, flash media, etc.

Use the Open and Up buttons to move to the desired directory, and then select the desired menu command. For general information on using the file browser, see “0-1: Load” on page 697.

When you execute a Save operation, the data will be saved in the current directory.

⚠ Do not turn off the power for at least 10 seconds after using any of the **Save** commands. This allows the system time to complete the process, which may continue in the background even after the disk operation appears to be complete.

File date and time

The NAUTILUS contains an internal calendar and clock. When you save a file, it is marked with the current date and time. This can be particularly helpful if you have more than one version of a file, since it lets you see which version is the most recent.

To set the current date and time for the NAUTILUS system, use the Utility page menu command **Set Date/Time**. For more information, see “Set Date/Time” on page 727.

✓ 0-2: Page Menu Commands

- Hide unknown files →p.703
- Translation →p.703
- Show L/R as Stereo Pair →p.703
- Lock/Unlock selected →p.703
- Save All (PCG, SNG and KSC) →p.720
- Save PCG & SEQ →p.721
- Save PCG →p.722
- Save SEQ →p.722
- Save Sampling Data →p.722
- Save to Standard MIDI File →p.723
- Save Exclusive →p.724
- Save Effect Preset →p.724
- Export Samples as AIF/WAV →p.724

- PAGE →p.126
- MODE →p.126

0-3: Utility



Here you can rename, copy, or delete the selected drive or file, create a new directory, format, and set the date and time.

After selecting a folder or file, select the desired menu command.

For general information on using the file browser, see “0-1: Load” on page 697.

-  Do not turn off the power for at least 10 seconds after using any of the **Utility** commands. This allows the system time to complete the process, which may continue in the background even after the drive operation appears to be complete.

✓ 0-3: Page Menu Commands

- Hide unknown files →p.703
- Translation →p.703
- Show L/R as Stereo Pair →p.703
- Lock/Unlock selected →p.703
- Rename →p.726
- Copy →p.726
- Delete →p.726
- Delete Unused WAV Files →p.727
- Create Directory →p.727
- Set Date/Time →p.727
- Format →p.727
- Convert to ISO9660 Format →p.728
- Rate Convert →p.728
- Check Medium →p.728
- Install EXs →p.729

- PAGE →p.126
- MODE →p.126

0-9: Media Info

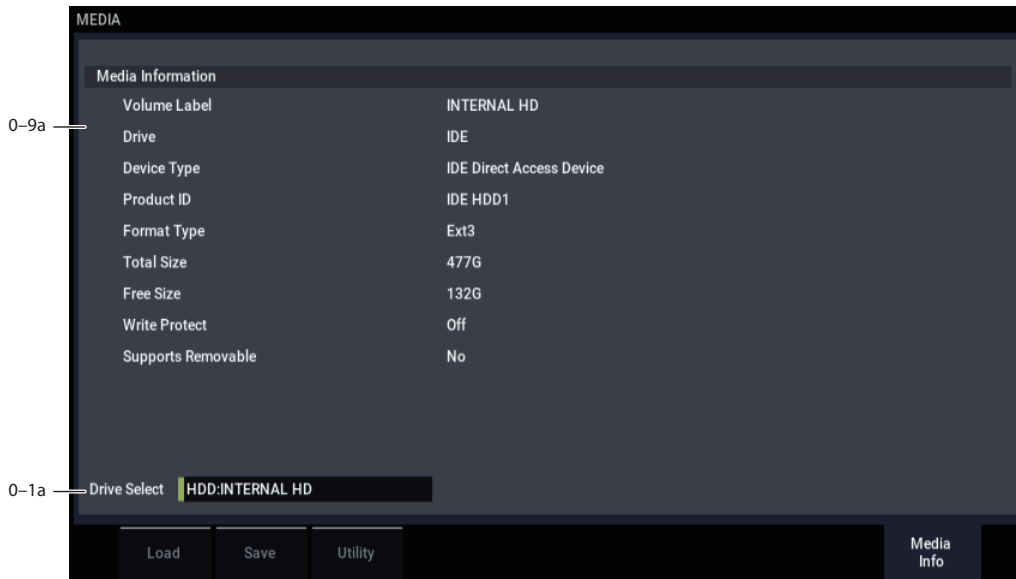

This screen shows information about the media. Use “Drive Select” to select the media.

0-9a: Media Information

Volume Label: The volume label of the media.

Drive: This is the specified drive.

Device Type: The type of media.

Product ID: The vendor ID, product, and product version, etc.

Format Type: The type of format. If not formatted, this will indicate “Unformatted.”

Total Size: The capacity of the media (in bytes).

Free Size: The free capacity of the media (in bytes).

Write Protect: The write protect status of the media. This will indicate “On” if protected, or “Off” if not protected.

Supports Removable: This will indicate “Yes” if the media of the selected device can be removed (e.g., Compact Flash, CD-R/RW disc, MO disc, removable hard disk). If the media is fixed, this will be “No.”

Drive Select

Selects the drive.

MEDIA: Page Menu Commands

| | |
|-----------------------------|--------|
| Hide unknown files | →p.703 |
| Translation | →p.703 |
| Show L/R as Stereo Pair | →p.703 |
| Lock/Unlock selected | →p.703 |
| Load selected | →p.703 |
| Load PCG (RAM) and Samples | →p.719 |
| Save All (PCG, SNG and KSC) | →p.720 |
| Save PCG & SEQ | →p.721 |
| Save PCG | →p.722 |
| Save SEQ | →p.722 |
| Save Sampling Data | →p.722 |
| Save to Standard MIDI File | →p.723 |
| Save Exclusive | →p.724 |
| Save Effect Preset | →p.724 |
| Export Samples as AIF/WAV | →p.724 |
| Rename | →p.726 |
| Copy | →p.726 |
| Delete | →p.726 |
| Delete Unused WAV Files | →p.727 |
| Create Directory | →p.727 |
| Set Date/Time | →p.727 |
| Format | →p.727 |
| Convert to ISO9660 Format | →p.728 |
| Rate Convert | →p.728 |
| Check Medium | →p.728 |
| Install EXs | →p.729 |
| PAGE | →p.126 |
| MODE | →p.126 |

0-1: Load Page Menu Command

Hide unknown files

When this option is turned on, files not recognized by the NAUTILUS will not be shown in the directory window.

To turn **Hide unknown files** on and off, simply select the command in the menu. When on, a check mark will appear at the left of the name.

Note: This option applies only if there are DOS files in the current directory.

Translation

When **Translation** is off (not checked), Multisample (.KMP) and Sample (.KSF) files will be shown with their low-level DOS file names—for example, “TROMB073.KMP.”

When **Translation** is on (checked), you’ll see the full 16-character Multisample and Sample names, as shown elsewhere in the system—for example, “Trombone Section.”

Show L/R as Stereo Pair

This command is only available when browsing into a .KSC file.

When this is enabled (shown as checked in the menu), stereo Multisamples, Drum Samples, and Samples in the KSC will appear as a single entry in the form of [name]-St. This can make long lists more compact and easier to read.

When this is disabled (shown as un-checked in the menu), the left and right channels of stereo Multisamples, Drum Samples, and Samples will appear individually in the form of [name]-L and [name]-R.

Lock/Unlock selected

This locks/unlocks the file or directory that’s selected in the directory window (0-1c). If you lock the file or directory, the lock icon (“Lock”) will appear, and overwriting, copying, or deleting will not be possible.

1. In the directory window (0-1c), select the file or directory that you want to lock or unlock.
2. Select “Lock/Unlock”; the selected file or directory will alternately be locked or unlocked.

Load selected

This loads the file or directory selected in the directory window (0-1c) into internal memory.

1. In the directory window (0-1c), select the file or directory that you want to load.
2. Select “Load selected.”

A dialog box will appear. The dialog box that appears will contain different options, depending on the file you are loading. For more information, please see the list of specific file types below.

Specify the various items as necessary.

3. To load the data, press the OK button. If you decide to cancel, press the Cancel button.

For more information on loading specific file types, please see:

Program data

- “Load .PCG” on page 705
- “Load Programs” on page 706
- “Load Program Bank” on page 706
- “Load a Program” on page 706

Combination data

- “Load Combinations” on page 707
- “Load Combination Bank” on page 707
- “Load a Combination” on page 707
- “Load Drum Kits” on page 707

Global data

- “Load Drum Kit Bank” on page 707
- “Load a Drum Kit” on page 708
- “Load Wave Sequences” on page 708
- “Load Wave Sequence Bank” on page 708
- “Load a Wave Sequence” on page 709
- “Load Global Setting” on page 709

Sequencer data

- “Load .SNG” on page 709
- “Load a Song” on page 710
- “Load Tracks” on page 710
- “Load Pattern Data” on page 710
- “Load Regions” on page 710
- “Load a Region” on page 711

Effects data

- “Load .KFX (FX Presets)” on page 711
- “Load All Presets (P01...15)” on page 711
- “Load All Presets (U00...15)” on page 711
- “Load Presets (P01-15)” on page 711
- “Load Presets (U00...15)” on page 711
- “Load a Preset (P)” on page 711

MIDI and SysEx files

- “Load Standard MIDI File” on page 712
- “Load and Transmit MIDI Exclusive Data” on page 712
- “Load DX Program Bank .SYX file” on page 719

Sample data

- “Loading sample data” on page 712
- “Load .KSC” on page 714
- “Load .KMP” on page 715
- “Load .KSF” on page 715
- “Loading AIFF and WAVE files” on page 715
- “Load .AIF” on page 716
- “Load .WAV” on page 716
- “Loading AKAI S1000/S3000 format Sample files, Program files, or Volumes” on page 716
- “Load AKAI Sample File” on page 716
- “Load AKAI Program File” on page 717
- “Load AKAI Volume” on page 717

ARP data

- “Load Arpeggio Patterns” on page 708
- “Load Arpeggio Pattern Bank” on page 708
- “Load an Arpeggio Pattern” on page 708

Other data

- “Load PCG (RAM) and Samples” on page 719

If a file to be loaded cannot be found, or when loading a file that was saved across media

If a necessary file cannot be found in the current directory or in a lower directory when loading multisamples, sample data, .PCG, or .SNG files, a dialog box like the following (Where is a ...) will appear.



This will appear in the following cases.

- If when loading a .KSC file, a .KMP file used by it cannot be found.
- If when loading a .KMP file, a .KSF file cannot be found.
- If when loading an S1000/S3000 format Program file, a Sample file cannot be found.
- If loading a .KSF file that was larger than the media capacity and was therefore saved on multiple media, when the first media has been loaded and the second media needs to be specified.
- When loading a .PCG file that was split across two or more volumes of media, when the first volume has been loaded and the second media is now required.
- When loading a .PCG file and also simultaneously loading a .SNG file, if the identically-named .SNG file is not found in the current directory after loading the .PCG file.

If this dialog box appears, take the following action.

1. Select the directory that contains the file indicated by “Where is a...”

If the specified file is located on another media, exchange media. Then press the directory window in the LCD screen to make the NAUTILUS recognize the media, and select the appropriate directory.

 It is not possible to open .PCG, .SNG, or .KFX files in the “Where is a ...” dialog box. The Open button cannot be used for .PCG, .SNG or .KFX files.

2. Press the Select button to resume loading.

Loading will be aborted if you press the Cancel button. If you want to abort the loading process, press the OK button. If you press the Skip button, the indicated file will be skipped, and the next file will be loaded.

Except for special situations such as when the media containing the indicated file has been damaged or cannot be found, you should use the Select button to continue the loading process.

Load .PCG 

Data in the .PCG file will be loaded.

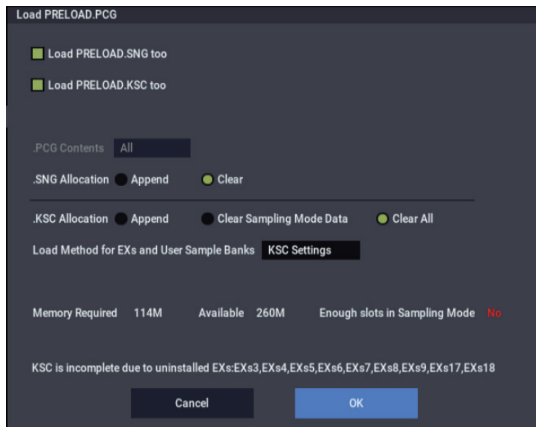

1. Use the “Load ***** .SNG too”, “Load ***** .KSC too” and check boxes to select the .SNG file and .KSC file.

If this file does not exist in the current directory, load it as described under “If a file to be loaded cannot be found, or when loading a file that was saved across media” on page 704.

2. In “.PCG Contents,” specify the data to be loaded.

All: Load all data from the .PCG file.

Bank A-T: Load only the data of the specified bank. In this case, use “To” to specify the load destination bank. When you press OK, the Combinations, Programs, Drum Kits, and Wave Sequences of the specified bank will be loaded to the destination bank. Global settings will not be loaded.

Within the loaded data, all bank references (from Combinations to Programs, and from Programs to Wave Sequences and Drum Kits) will be adjusted automatically to match the destination bank. For instance, if you load Bank B into Bank T, Combi Timbres which previously referred to Programs in Bank B will be changed to Bank T. Only references to the original bank will be adjusted; for instance, if you load Bank I, references to Bank F will remain unchanged.

If a .SNG file is loaded simultaneously, banks will also be adjusted for both Tracks and any Bank Change messages within the sequencer data.

Note that types (HD-1 or EXi) of the loaded and destination banks do not matter;

Note that it doesn’t matter whether the loaded bank is HD-1 or EXi; the system will automatically set the destination bank’s type appropriately.

 If the specified bank is not included in the .PCG file, the error “No readable data” will appear, and the load operation will be halted.

3. If “Load ***** .SNG too” is checked, you can use “Select .SNG Allocation” to specify how song data within the .SNG file will be loaded.

.SNG Allocation

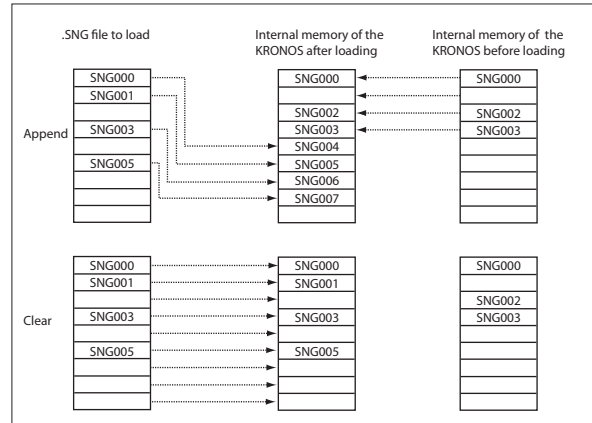

Append: The data will be loaded into song numbers starting after the last song in memory which contains data. The song data within the .SNG file that is being loaded will be packed into the available locations. (See diagram below)

Select this method when you wish to load song data from drive without erasing the song data that is already in memory.

The region data used by the song’s audio tracks will be loaded following the last existing region number, with valid data packed into each consecutive location. (See diagram below) At this time, the region numbers of the song will be reassigned so that the songs in the .SNG file that use region data will correspond correctly to the region data.

Clear: Song data already in internal memory will be completely erased, and the song data will be loaded in the configuration that existed when it was saved. (See diagram below)

Select this when you want to reproduce the saved state immediately after power-on, etc.

4. “.KSC Allocation” is valid if “Load ***** .KSC too” has been checked.

This specifies how the Multisamples, Samples, and Drum Samples in the .KSC file will be loaded.

Append will leave all currently-loaded SAMPLING mode, EXs, and User Sample Bank data intact. SAMPLING mode Multisamples and Samples will be loaded into the next available vacant numbers following the existing data. (See diagram below.)

If the PCG’s Programs, Wave Sequences, and Drum Kits use the KSC’s SAMPLING mode data, the system will automatically remap the Multisample and Sample references so that everything plays correctly.

Clear Sampling mode Data will erase all Multisamples and Samples from SAMPLING mode, and load the data in the same configuration with which it was saved. Existing EXs and User Sample Bank data is left intact.

Clear All is similar to **Clear Sampling mode Data**, above, but also un-loads existing EXs and User Sample Bank data before loading the new .KSC file. This frees up the most memory for the new .KSC.

You can use the information at the bottom of the dialog box, including **Memory Required**, (Memory) **Available**, and **Enough slots for Samples & MS**, to determine whether or not you need to free up room for the new .KSC.

.KSC Allocation

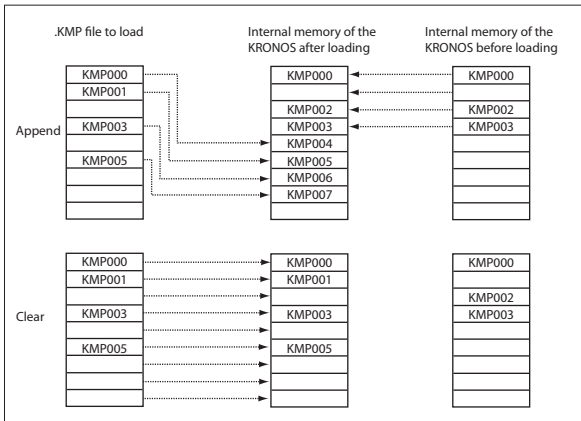

5. Set the Load Method as desired.

This sets the preferred way to load the EXs and User Sample Bank data in the KSC: load it into RAM, or use Virtual Memory. Note that if the data is extremely large, and would not fit into RAM regardless of which other samples were loaded, the data will use Virtual Memory regardless of this setting.

These settings apply only to EXs and User Sample Banks; SAMPLING mode data is always loaded into RAM.

RAM: The samples will be loaded into RAM. This has the advantage of allowing reverse playback.

Virtual Memory: The samples will use Virtual Memory. This generally allows you to load more large samples at once. Note that the samples may still require a significant amount of RAM.

KSC Settings: KSCs can store separate load method settings for each Multisample or Drum Sample, based on the settings when the KSC was saved. Setting **Load method** to **KSC Settings** uses these individual settings.

6. To load the data, press the OK button. To cancel without loading, press the Cancel button.

Load Programs 

All program data from the .PCG file will be loaded.

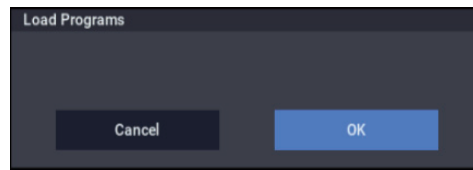

1. To load the data, press the OK button. To cancel without loading, press the Cancel button.

Load Program Bank 

[A...T]

All program data of the selected bank will be loaded into the bank you specify.

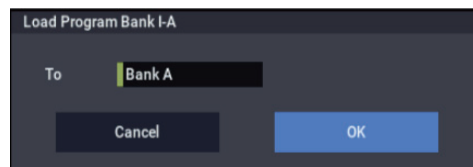

1. In "To," select the loading destination bank.
2. To load the data, press the OK button. To cancel without loading, press the Cancel button.

Note: Data cannot be loaded into Bank GM.

You can load banks of a different type (HD-1 or EXi) from the NAUTILUS's current bank type setting; the bank type will be changed automatically as required.

If "Multiple Select" (0-1a) is checked and you've selected more than one bank, the data will be loaded starting with the bank specified in the "To" field.

Load a Program 

Data for the selected program will be loaded into the program number you specify.

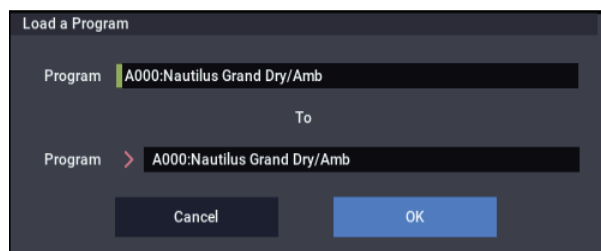

1. If you wish to load a program other than the one already selected, use "Program" (upper line) to select the program that you wish to load.

Note: Whenever you've selected an individual Program, Combination, Drum Kit, or Wave Sequence from within a PCG file, you can play it from the keyboard immediately--no need to load it into memory! For more information, see "Auditioning sounds from disk" on page 697.

2. In "To Program," (lower line) select the bank and program into which the data will be loaded. When you press the popup button, the "Bank/Program Select" window (PROGRAM 0-1a) will appear.

Note: You cannot set the “To” field to a bank whose type differs from the selected program.

Note: If “Multiple Select” (0–1a) is checked and you’ve selected more than one program, the data will be loaded starting with the program you specified in the “To” field.

3. To load the data, press the OK button. To cancel without loading, press the Cancel button.

Load Combinations

All combinations in the .PCG file will be loaded.

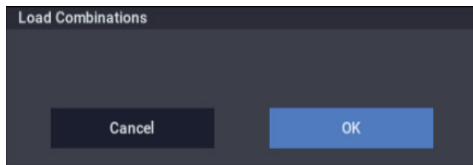

1. To load the data, press the OK button. To cancel without loading, press the Cancel button.

Load Combination Bank

[A...T]

All combinations in the selected bank will be loaded into the bank you specify.

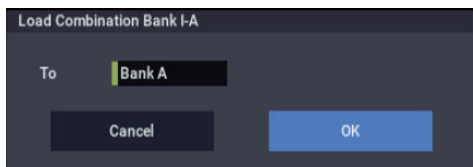

1. In “To,” specify the loading destination bank.
2. To load the data, press the OK button. To cancel without loading, press the Cancel button.

Note: If “Multiple Select” (0–1a) is checked and you’ve selected more than one bank, the data will be loaded starting with the bank you specified in the “To” field.

Load a Combination

This loads the selected Combination into a specified Bank and number in internal memory.

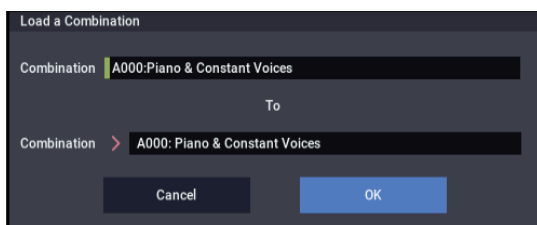

1. If you wish to load a combination other than the one already selected, use “Combination” (upper line) to select the combination that you wish to load.

Note: The selected combination can be played from the keyboard even before you load it. This is convenient when you want to audition the combination to be loaded. (See “Auditioning sounds from disk” on page 697)

2. In “To Combination” (lower line), select the bank and combination into which the data will be loaded.

When you press the popup button, the “Bank/Combination Select” window will appear.

3. To load the data, press the OK button. To cancel without loading, press the Cancel button.

Note: If “Multiple Select” (0–1a) is checked and you’ve selected more than one combination, the data will be loaded starting with the combination you specified in the “To” field.

Load Drum Kits

All drum kits in the .PCG file will be loaded.

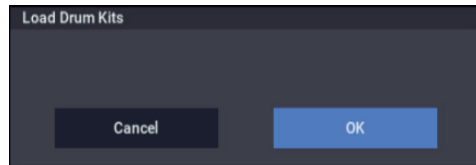

1. To load the data, press the OK button. To cancel without loading, press the Cancel button.

Load Drum Kit Bank

[000-039(A)...257-272(O)]

This loads all drum kit data of the selected bank into the load-destination bank you specify.

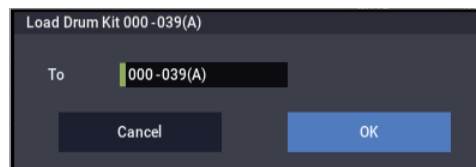

1. Use the “To” field to select the load-destination bank.
2. To load the data, press the OK button. To cancel without loading, press the Cancel button.

Note: If “Multiple Select” (0–1a) is checked and you’ve selected more than one bank, the data will be loaded starting with the bank you specified in the “To” field.

- ⚠ The A bank can hold 40 Drum Kits, while each B–O bank can hold only 16. If you load from a stored A bank into one of the B–O banks, only the first 16 Drum Kits will be loaded (000 ...015). Conversely, if you load from a stored B–O bank into the A bank, the Drum Kits will be loaded into the first 16 slots (000 ...015), and the remaining Drum Kits will be unaffected.

Load a Drum Kit

The selected drum kit will be loaded into the drum kit number you specify.

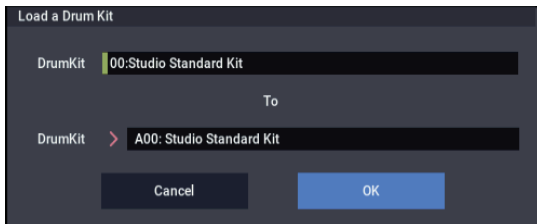

1. If you wish to load a drum kit other than the one already selected, use “Drum Kit” (upper line) to select the drum kit you wish to load.

Note: Whenever you’ve selected an individual Program, Combination, Drum Kit, or Wave Sequence from within a PCG file, you can play it from the keyboard immediately—no need to load it into memory! For more information, see “Auditioning sounds from disk” on page 697.

2. In “To Drum Kit” (lower line), select the loading destination drum kit.
3. To load the data, press the OK button. To cancel without loading, press the Cancel button.

Note: If “Multiple Select” (0–1a) is checked and you’ve selected more than one bank, the data will be loaded starting with the drum kit you specified in the “To” field.

Load Arpeggio Patterns

This loads all arpeggio pattern data in the .PCG file.

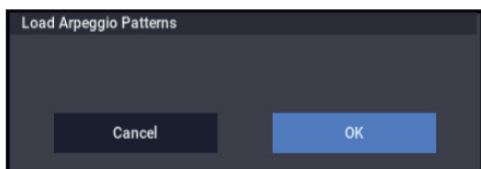

1. Press the OK button if you want to load, or press the Cancel button if you decide not to load.

Load Arpeggio Pattern Bank

Loads all arpeggio pattern data in the selected bank into the bank specified for the load destination.



1. Use “To” to select where to load the data.
2. Press the OK button if you want to load, or press the Cancel button if you decide not to load.

Load an Arpeggio Pattern

Loads the selected single arpeggio pattern data into the arpeggio pattern number selected as the load destination.

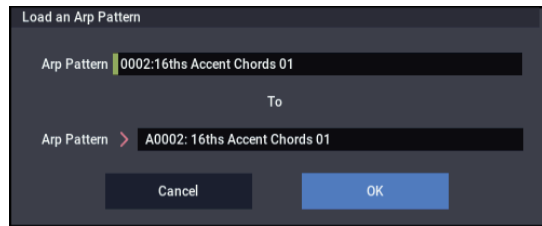

1. For the “Arp Pattern” (upper row), when loading an arpeggio pattern other than the one selected, reselect the arpeggio pattern to load.

Note: The selected arpeggio pattern will sound when you play the keyboard, even if it hasn’t been loaded yet. This is useful when you want to check the arpeggio patterns before loading them. For more information, see “PCG Preview” on page 698.

2. For the other “Arp Pattern” (lower row), select where you want to load the arpeggio pattern.
3. Press the OK button if you want to load, or press the Cancel button if you decide not to load.

Note: If “Multiple Select”(0–1a) is selected and you’ve selected more than one wave sequence, the data will be loaded starting with the wave sequence you specified in the “To” field.

Load Wave Sequences

All wave sequence data of the .PCG file will be loaded.

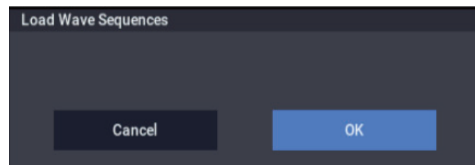

1. To load the data, press the OK button. To cancel without loading, press the Cancel button.

Load Wave Sequence Bank

[000-149(A)...566-597(O)]

All wave sequence data of the selected bank will be loaded into the bank you select as the load-destination.

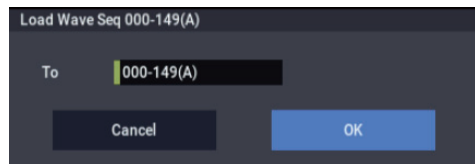

1. Use the “To” field to select the load-destination bank.
2. To load the data, press the OK button. To cancel without loading, press the Cancel button.

Note: If “Multiple Select” (0–1a) is checked and you’ve selected more than one bank, the data will be loaded starting with the bank you specified in the “To” field.

- The A bank can hold 150 Wave Sequences, while each B–O bank can hold only 32. If you load from a stored A bank into one of the B–O banks, only the first 32 Wave Sequences will be loaded (000 ...031). Conversely, if you load from a stored B–O bank into the A bank, the Wave

Sequences will be loaded into the first 32 slots (000 ...031), and the remaining Wave Sequences will be unaffected.

Load a Wave Sequence

The selected wave sequence data will be loaded into the wave sequence number you select as the load-destination.

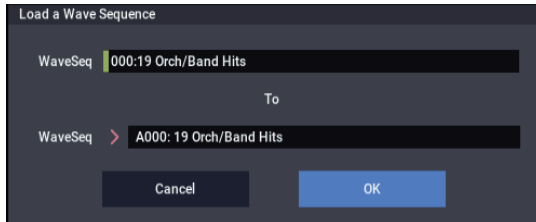

1. If you want to load a wave sequence other than the selected wave sequence, use “Wave Sequence” (the upper line) to re-select the wave sequence to be loaded.
Note: Whenever you’ve selected an individual Program, Combination, Drum Kit, or Wave Sequence from within a PCG file, you can play it from the keyboard immediately—no need to load it into memory! For more information, see “Auditioning sounds from disk” on page 697.
2. Use “To Wave Sequence” (the lower line) to select the load-destination wave sequence.
3. To load the data, press the OK button. To cancel without loading, press the Cancel button.

Note: If “Multiple Select” (0–1a) is checked and you’ve selected more than one wave sequence, the data will be loaded starting with the wave sequence you specified in the “To” field.

Load Global Setting

Global setting data in the .PCG file will be loaded.

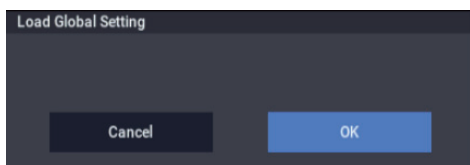

This includes most of the GLOBAL mode parameters, except for the following:

- Drum Kits
- Wave Sequences
- Memory Protect settings
- System Clock setting

1. To load the data, press the OK button. To cancel without loading, press the Cancel button.

Load .SNG

All data in the .SNG file will be loaded.

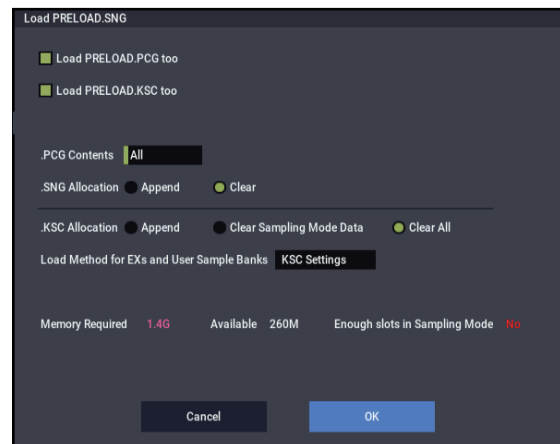

1. Use “Select .SNG Allocation” to specify how the song data from the .SNG file will be loaded.

Append: The data will be loaded into song numbers starting after the last song in memory which contains data. At this time, the song data in the .SNG file being loaded will be packed forward. (See the diagram “.SNG Allocation” on page 705)

Select this when you want to add song data from drive without erasing the song data that currently exists in internal memory.

The region data used by the song’s audio tracks will also be loaded following the last region number existing in internal memory, with valid data packed into each consecutive location. At this time, the region numbers of the song will be reassigned so that the songs in the .SNG file that use region data will correspond correctly to the region data.

Clear: Song data already in internal memory will be completely erased, and the song data will be loaded in the configuration that existed when it was saved. (See the diagram “.SNG Allocation” on page 705)

Select this when you want to reproduce the saved state immediately after power-on, etc.

2. If an identically-named .PCG, or .KSC file exists in the current directory, you’ll be able to select the “Load *****.PCG too,” and “Load *****.KSC too,” check boxes.

If this file does not exist in the current directory, load it as described under “If a file to be loaded cannot be found, or when loading a file that was saved across media” on page 704.

- If you check “Load *****.PCG too,” use “.PCG Contents” to specify the bank within the .PCG file. For more information, see “In “.PCG Contents,” specify the data to be loaded.” on page 705.
 - If you check “Load *****.KSC too,” use “.KSC Allocation” to specify how the multisamples and samples within the .KSC file will be loaded. For more information, see “.KSC Allocation” is valid if “Load *****.KSC too” has been checked.” on page 705.
3. Press the OK button to load the data, or press the Cancel button to cancel without loading.

Load a Song

Data for the selected song will be loaded into the song number you specified as the load destination.

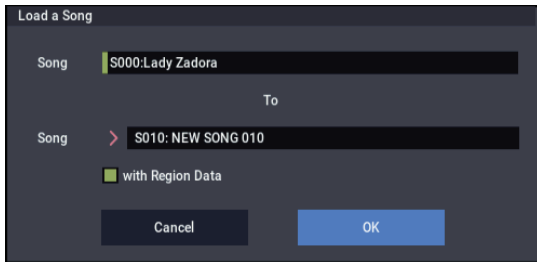

1. If you wish to load a song other than the selected song, use Song (upper line) to re-select the song to be loaded.
2. In “To Song” (lower line), select the loading destination song.
3. If you’ve enabled the “with Region Data” check-box, the Song’s region data will be loaded following the last region number existing in internal memory, with data packed into each consecutive location (Append load).
At this time, the region numbers of the song will be reassigned so that they correspond correctly to the region data.
4. To load the data, press the OK button. To cancel without loading, press the Cancel button.

Load Tracks

The event data of all tracks in the selected song will be loaded into the song you specify as the loading destination. However, it is not possible to specify an uncreated song as the loading destination.

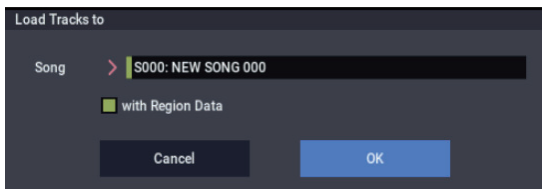

1. In Song, specify the loading destination song.
2. If you’ve enabled the “with Region Data” check-box, the region data used by the song tracks being loaded will also be loaded following the last region number existing in internal memory, with data packed into each consecutive location (Append load).
At this time, the region numbers of the tracks in the song will be reassigned so that they correspond correctly to the region data.
3. To load the data, press the OK button. To cancel without loading, press the Cancel button.

Load Pattern Data

The selected user pattern will be loaded into a user pattern of the selected loading destination song.

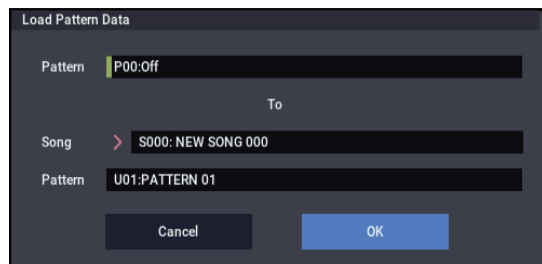

1. If you wish to load a user pattern other than the one already selected, use Pattern (upper line) to re-select the user pattern that you wish to load.
2. In “To Song” and Pattern (lower line), select the loading destination song and user pattern.
3. To load the data, press the OK button. To cancel without loading, press the Cancel button.

Load Regions

All region data will be loaded from the .SNG file.

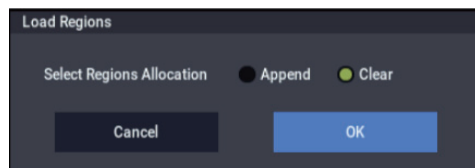

1. Use “Select Regions Allocation” to specify how the song data in the .SNG file will be loaded.
Append: The data will be packed into each consecutive location following the last region number existing in internal memory. Choose this method when you want to load additional region data from the drive without erasing the region data already in internal memory.
Clear: All region data in internal memory will be erased, and the region data will be loaded in the configuration that existed when it was saved. Choose this method when you want to replicate the configuration that you saved, such as immediately after turning the power on.
 If you load using Append, the region numbers used by the song may no longer correspond correctly. If so, you will need to re-select the region numbers used by the song. When loading song data, you will normally use Load .SNG or Load a Song and check the “with Region Data” setting. Even if you load using Append, the region numbers of the song will automatically be re-specified so that the song will correspond to the correct region data.
2. To load the data, press the OK button. To cancel without loading, press the Cancel button.

Load a Region 

This loads the selected region data into the region number you select as the load-destination.

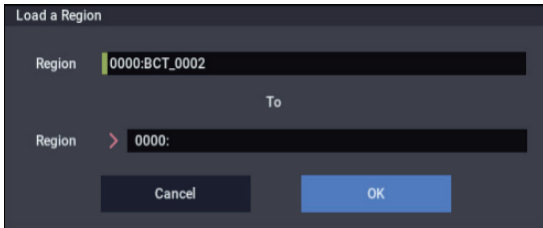

1. If you're loading region data other than the selected data, use "Region" (the upper line) to reselect the region data you want to load.
2. Use "To Region" (the lower line) to select the load-destination region.
3. To load the data, press the OK button. To cancel without loading, press the Cancel button.

Load .KFX (FX Presets) 

All data from the .KFX file will be loaded. All preset data (P01–15) and user data (U00–15) for all effects will be loaded.

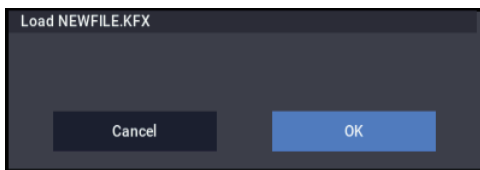

1. To load the data, press the OK button. To cancel without loading, press the Cancel button.

Load All Presets (P01...15) 

All preset data from the .KFX file will be loaded. All presets (preset) data (P01–15) for all effects will be loaded.

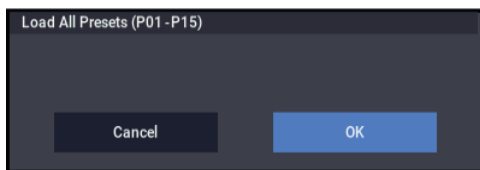

1. To load the data, press the OK button. To cancel without loading, press the Cancel button.

Load All Presets (U00...15) 

All user data from the .KFX file will be loaded. All preset (user) data (U01–15) for all effects will be loaded.

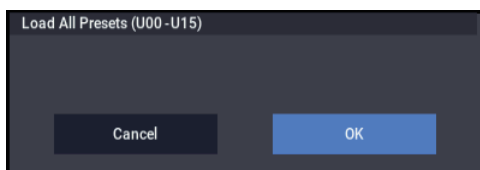

1. To load the data, press the OK button. To cancel without loading, press the Cancel button.

Load Presets (P01–15) 

Preset (preset) data (P01–15) for the selected effect will be loaded.

Load Presets (P01-P15) in "Stereo Dyna Compressor"

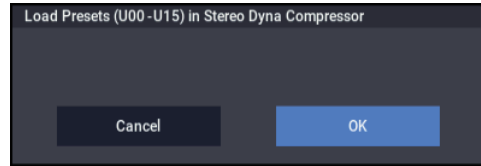

1. To load the data, press the OK button. To cancel without loading, press the Cancel button.

Load Presets (U00...15) 

Preset (user) data (U00–15) for the selected effect will be loaded.

Load Presets (U00-U15) in "Stereo Dyna Compressor"

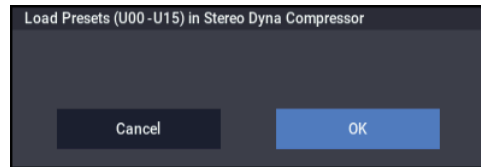

1. To load the data, press the OK button. To cancel without loading, press the Cancel button.

Load a Preset (P) 

The selected effect preset data (P01–15) will be loaded into the load-destination effect preset number (P01–15, U00–U15) you specify.

Load a Preset in "Stereo Dyna Compressor"

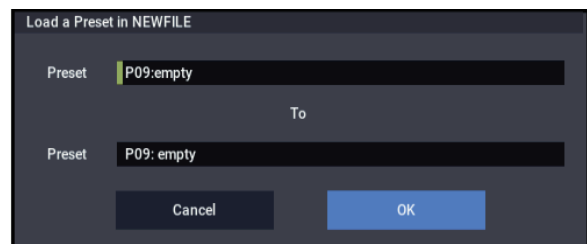

1. If you're loading an effect preset other than the selected one, use "Preset" (the upper line) to re-select the effect preset that will be loaded.
2. Use "To Preset" (the lower line) to select the load-destination effect preset.
3. To load the data, press the OK button. To cancel without loading, press the Cancel button.

Note: If "Multiple Select" (0–1a) is checked and you've selected more than one effect preset, the data will be loaded starting with the effect preset you specified in the "To" field.

Load a Preset (U)



The selected effect preset data (U00–15) will be loaded into the load-destination effect preset number (P01–15, U00–U15) you specify.

For more information, see “Load a Preset (P)” on page 711.

Load Standard MIDI File



The selected Standard MIDI File will be loaded into the song number you select as the loading destination.

“Load Standard MIDI File *****.MID to”

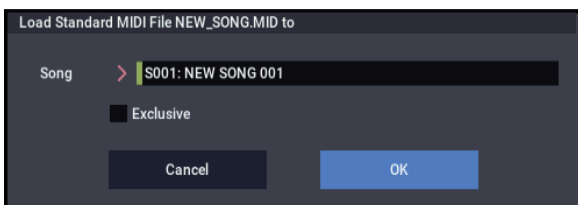

1. In Song, select the loading destination song.
2. If you turn “Exclusive” Off (unchecked), any system exclusive messages or universal exclusive messages included in the SMF data will not be loaded.

If this is On (checked), system exclusive messages and universal exclusive messages included in the SMF data will be loaded as System Exclusive events.

The GS/XG sound maps and messages are not supported. Depending on the content of the data, it may not play back correctly, but the data itself will be maintained if **Exclusive** is checked.

3. To load the data, press the OK button. To cancel without loading, press the Cancel button.

If you select an undefined file and choose **Load selected**, the file will be assumed to be a Standard MIDI File, and the **Load Standard MIDI File** dialog box will appear. When you execute loading, the file will be loaded into the song that was specified as the loading destination. However if the file format is inappropriate, the operation will be invalid and an error message will be displayed.

The program bank and program numbers loaded into the song will follow the “Bank Map” (GLOBAL 0–1d) setting. If “Bank Map” is Korg, bank A will be selected for bank select 00.00 (MSB.LSB). If “Bank Map” is GM(2), bank G will be selected.

Load and Transmit MIDI Exclusive Data



All data from the .EXL file will be loaded and transmitted from the MIDI OUT connector.

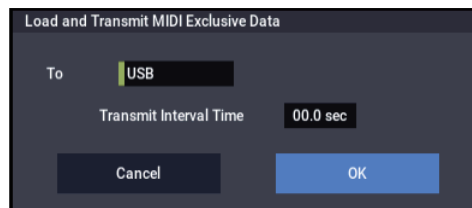

1. If the .EXL file contains two or more exclusive data items, use “Transmit Interval Time” to specify the time interval that will be inserted between each item of exclusive data.

If you are transmitting the data to another NAUTILUS, the required time interval will depend on the type of data. After transmitting all program data, you must allow an interval of approximately 2 seconds. For more information, see “System Exclusive Data Dumps” on page 691. For other MIDI devices, refer to their owner’s manual.

2. To load the data, press the OK button. To cancel without loading, press the Cancel button.

The maximum data size that can be transmitted is 1,048,576 bytes.

Load Drum Track Patterns



This command loads all drum track user patterns from the .PCG file.

Load a Drum Track Pattern



This command loads the selected single drum track user pattern data into the drum track user pattern location that you specify as the load-destination.

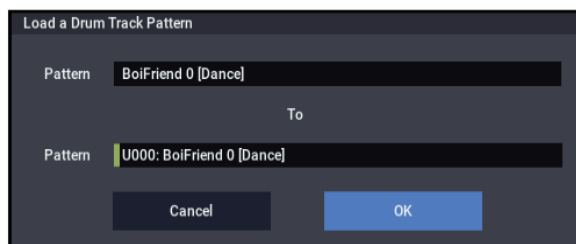

1. If you want to load a pattern other than the selected pattern, use “Pattern” (the upper field) to re-select the pattern that you want to load.
2. Use the “To Pattern” field (the lower field) to specify the load-destination pattern.

Loading sample data

The explanations under Load .KSC, Load .KMP, and Load .KSF, below, explain how Korg format PCM data files are loaded into SAMPLING mode.

About sample RAM

The amount of RAM available for SAMPLING mode will vary, depending on both the amount of physical RAM, and which (if any) EXs or User Sample Bank data is currently loaded. For more information, see “Sampling and RAM” on page 571.

Maximum numbers of Samples and Multisamples that can be loaded into SAMPLING mode

- Multisamples: up to 4,000
- Samples: up to 16,000
- Samples used by multisamples (“Indexes”): up to 16,000

About Korg format PCM data files

KSC files



KSC stands for Korg Sample Collection. KSC files contain links to SAMPLING mode, EXs, and/or User Sample Bank data, including Multisamples, Samples, and Drum Samples. Loading a KSC file loads all of the linked sample data, including .KMP and .KSF files as well as EXs and/or User Sample Bank data.

When saving, a .KSC file and a directory with the same name as the .KSC file will be created. The .KMP files and .KSF files listed in the .KSC file will be saved in this directory. EXs and User Sample Bank data are only linked, and not saved again.

For more information on User Sample Banks, see “User Sample Banks” on page 151 of the OG.

KMP files



Files with the extension .KMP (Korg Multisample Parameters) contain the parameters which make up a single multisample. These parameters also include the filename of the .KSF files that are used by that multisample, so when a .KMP file is loaded, the necessary .KSF files will also be loaded at the same time.

When saving, a .KMP file and a directory with the same name will be created, and the .KSF files used by the multisample will be saved in this directory.

KSF files



Files with the extension .KSF (Korg Sample File) contain the parameters and waveform data which make up a single sample.

A .KSF file can be used as one of the samples used by a multisample. A .KSF file can also be selected and used as a drum sample for a drum kit.

Loading multiple files at once

For simply selecting two or more files at once, just check the **Multiple Select** check-box at the bottom of the file list. You can then select multiple files within the directory, and load, copy, etc. all of them in a single operation.

For more complex file selections, or for selecting all the files within a directory, “wildcards” are useful. Wildcards are two special characters—the asterisk “*” and question mark “?”—which stand in for *any* other characters. The question

mark “?” stands for any single character, such as 4, y, or _; the asterisk “*” stands for any number of characters, one or more, such as 7, pno, or big_synth.

Wildcards are supported for many different sample file formats, including .KMP, .KSF, .AIF, .WAV, AKAI Program, AKAI Sample, and Sound Font 2.0.

Note: Wildcards only work on a single file type at a time, based on the file selected when Load is pressed. For example, if you select a .WAV file and press Load, wildcards will select only other .WAV files. Wildcards also only work within the current directory.

To use wildcards, select a file of the desired type (.WAV, for example), open the Load dialog box, and then press the text edit button to open the text input dialog box.

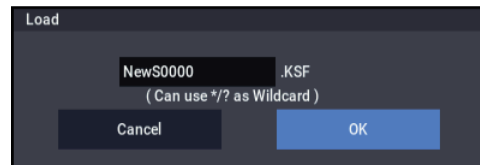

For instance, let’s say that a folder contains the following files:

- PIANO.WAV
- SFX_A_00.WAV
- SFX_A_01.WAV
- SFX_B_00.WAV
- SFX_B_01.WAV
- SFX_C_00.WAV



Select “SFX_A_00.WAV,” and choose “Load selected” to open the dialog box.

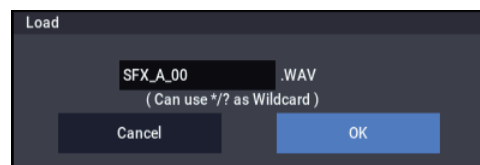

Press the text edit button (T) to open the text input dialog box, and enter the desired combination of text and wildcards. If a USB QWERTY keyboard (commercially available) is connected, you can use this to enter text instead of the on-screen keyboard.

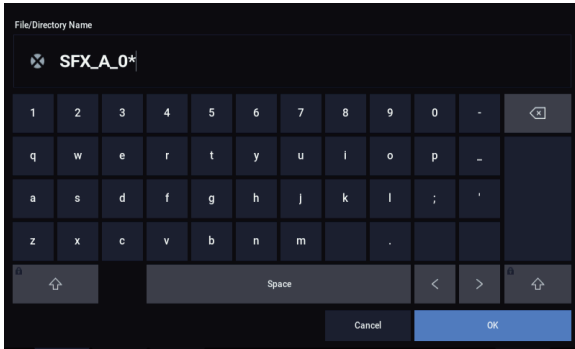

The “*” wildcard stands for any number of characters

The “?” wildcard stands for a single character

To load all of the WAVE files, enter only a single asterisk “*” and press OK.

If you enter SFX_A* and press OK, the following files will be loaded:

- SFX_A_00.WAV
- SFX_A_01.WAV

If you enter SFX_?_00 and press OK, the following files will be loaded:

- SFX_A_00.WAV
- SFX_B_00.WAV
- SFX_C_00.WAV

If you enter SFX_*_00 or SFX_* and press OK, the following files will be loaded:

- SFX_A_00.WAV
- SFX_A_01.WAV
- SFX_B_00.WAV
- SFX_B_01.WAV
- SFX_C_00.WAV

Load .KSC



This loads all of the SAMPLING mode, EXs, and/or User Sample Bank Multisamples, Samples, and Drum Samples linked within the KSC.

For more information on User Sample Banks, see “User Sample Banks” on page 151 of the OG.

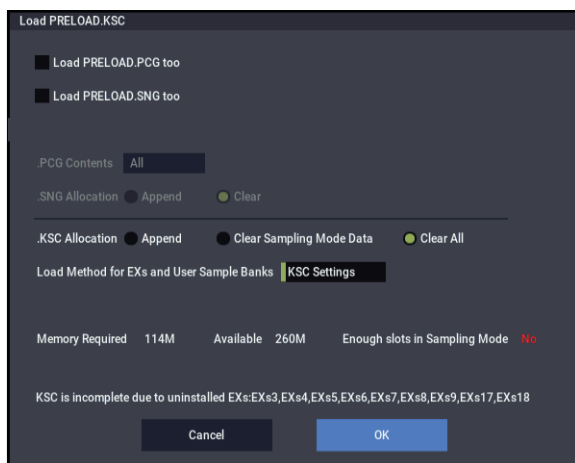

If the KSC includes SAMPLING mode data, the Multisamples and Samples (.KMP and .KSF files) are saved in an automatically-created directory with the same name as the .KSC file.

1. “KSC Allocation” allows you to specify how the multisamples and samples in the .KSC file will be loaded.

Append will leave all currently-loaded SAMPLING mode, EXs, and User Sample Bank data intact. SAMPLING mode Multisamples and Samples will be loaded into the next available vacant numbers following the existing data. (See the diagram “KSC Allocation” on page 706.)

If “Load *****.PCG too” is enabled, and the PCG’s Programs, Wave Sequences, and Drum Kits use the KSC’s SAMPLING mode data, the system will automatically remap the Multisample and Sample references so that everything plays correctly.

Clear Sampling mode Data will erase all Multisamples and Samples from SAMPLING mode, and load the data in the same configuration with which it was saved. Existing EXs and User Sample Bank data is left intact.

Clear All is similar to **Clear Sampling mode Data**, above, but also un-loads existing EXs and User Sample Bank data before loading the new .KSC file. This frees up the most memory for the new .KSC.

You can use the information at the bottom of the dialog box, including **Memory Required**, (**Memory**) **Available**, and **Enough slots for Samples & MS**, to determine whether or not you need to free up room for the new .KSC.

2. Set the Load Method as desired.

This sets the preferred way to load the KSC’s EXs and User Sample Bank data: load it into RAM, or use Virtual Memory. Note that if the data is extremely large, and would not fit into RAM even if no other samples were loaded, the data will be loaded into Virtual Memory regardless of this setting.

These settings apply only to EXs and User Sample Bank data; SAMPLING mode data is always loaded into RAM.

RAM: The samples will be loaded into RAM. This has the advantage of allowing reverse playback.

Virtual Memory: The samples will use Virtual Memory. This generally allows you to load more large samples at once. Note that the samples may still require a significant amount of RAM.

KSC Settings: KSCs can store separate load method settings for each Multisample or Drum Sample, based on the settings when the KSC was saved. Setting **Load method** to **KSC Settings** uses these individual settings.

3. If the current directory contains a .PCG file, and .SNG file of the same filename, you can select the “Load ***.PCG too” check box, and the “Load *****.SNG too” check box.**

(See “Load: .PCG: 1”)

- If you check “Load *****.PCG too,” the .PCG file of the same name as the .KSC file will also be loaded. (See “Load .PCG: 2”)
- If you check “Load *****.SNG too,” the .SNG file of the same name as the .KSC file will also be loaded. (See “Load .PCG: 3”)

4. To load the data, press the OK button. To cancel without loading, press the Cancel button.

If the .KSF files used by the .KMP file are not in the current directory or below it, a dialog box will appear, allowing you to specify the directory. For more

information, see “If a file to be loaded cannot be found, or when loading a file that was saved across media” on page 704.

Since overflow checking of sample RAM is performed when loading each individual .KSF file, it is possible that an overflow may occur in the middle of the loading process.

Loading individual files from within a .KSC file

Similar to .PCG files, you can browse inside a .KSC file as if it were a folder on the disk. You can use this to load individual Multisamples, Drum Samples, or Samples—including more than one at a time, using Multiple Select.

Groups of data appear with folder icons within the .KSC. As with folders on the disk, you can select one or more folders to load all of their contents, or open a folder to browse within.

The total size of all referenced files is shown to the right of each item’s name.

When you open a .KSC file, you’ll see folders for each EXs used by the .KSC. If the .KSC includes User Samples, there will also be a folder titled User Sample Data. The folder and file structure is as shown below.

User Sample Data folder

- Multisamples folder
 - Multisamples
 - Samples used by the Multisample
- Un-referenced Samples folder
 - All samples not in Multisamples

EXs(n) (Name)

- Multisamples folder
 - Multisamples
- Drum Samples
 - List of Drum Samples

To load data from within a .KSC:

1. Use the OPEN and UP buttons to browse through the KSC’s folders.
2. Select the data to load. Enable Multiple Select in order to select two or more items.
3. Press the LOAD button.
 - The Load Sample Data from KSC dialog will appear.
4. Set Sample & MS allocation to Append, Clear SAMPLING mode Data, or Clear All as desired.
5. If you’re loading EXs or User Sample Bank data, set the Load Method as desired.

For more information on the allocation and Load Method options, see “Load .KSC” on page 714.

Note the metrics in the dialog, which show the amount of memory required, the amount of memory available, and whether or not there are enough slots for the selected User data.

6. Press OK to load the data.

Load .KMP



The selected .KMP file will be loaded as a multisample. The .KSF files used by the .KMP will also be loaded as samples.

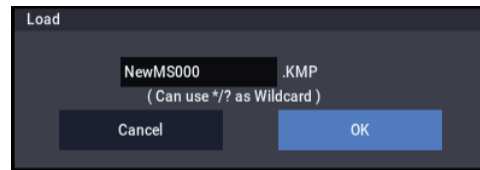

The .KSF files used by the .KMP file will be saved in an automatically-created directory with the same name as the .KMP file.

1. To load the data, press the OK button. To cancel without loading, press the Cancel button.

Samples will be loaded starting at the first unoccupied number following the last multisample or sample that currently exists in the sample memory. Only valid multisamples or samples will be packed and loaded (Append load).

If the .KSF files used by the .KMP file are not in the current directory or below it, a dialog box will appear, allowing you to specify the directory. For more information, see “If a file to be loaded cannot be found, or when loading a file that was saved across media” on page 704.

Since sample RAM overflow checking is performed when loading each .KSF file, an overflow may occur during the loading process.

Load .KSF



The selected .KSF file will be loaded as a sample.

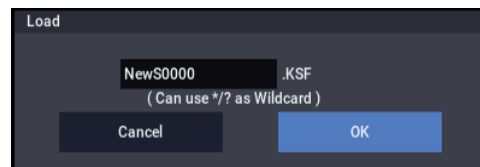

1. To load the data, press the OK button. To cancel without loading, press the Cancel button.

The sample will be loaded after the last Multisample or Sample that currently exists in SAMPLING mode (similar to loading with the Append option).

Loading AIFF and WAVE files

The NAUTILUS can load AIFF format or WAVE format files, which are formats used to save audio data on personal computers etc. When this data that has been loaded, it can be used as a sample or a drum sample.

Files with an extension of other than .AIF/.WAV cannot be recognized as AIFF/WAVE files. In this case, use the Utility “Rename” menu command to change the last four characters of the filename to “.AIF”/“.WAV”

If the data that is loaded as a sample contains a loop point, you can set **Start Offset** (PROGRAM 1–2a) on the NAUTILUS so that the sound will begin from the loop point.

 If data whose sample size is 8 bits or less is loaded, it will be converted into 16 bit data inside the NAUTILUS. This will mean that the amount of internal memory consumed will be approximately twice as large as the file size. The increase in size resulting from this conversion may mean that it is impossible to save that data on a media.

Load .AIF



The selected AIFF file will be loaded as a sample.

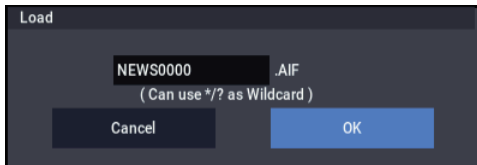

1. To load the data, press the OK button. To cancel without loading, press the Cancel button.

The sample will be loaded after the last Sample that currently exists in SAMPLING mode (similar to loading with the Append option).

Note: You can load multiple files at once, as long as they are in the same directory. See “Multiple Select” on page 698 and “Loading multiple files at once” on page 713

Load .WAV



The selected WAVE file will be loaded as a sample.

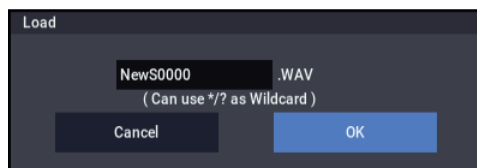

1. To load the data, press the OK button. To cancel without loading, press the Cancel button.

The sample will be loaded after the last Sample that currently exists in SAMPLING mode (similar to loading with the Append option).

Note: You can load multiple files at once, as long as they are in the same directory. See “Multiple Select” on page 698 and “Loading multiple files at once” on page 713

Loading AKAI S1000/S3000 format Sample files, Program files, or Volumes

The NAUTILUS can load AKAI S1000/S3000 format Samples, Programs, and Volumes. The sounds can then be used in SAMPLING mode, and saved as User Sample Banks.

The AKAI format uses the concept of “key groups.” For each key zone, up to four samples can be assigned, and these four can be switched or crossfaded by velocity. Key zones can also be crossfaded.

If you load an AKAI Program file into the NAUTILUS with **Advanced Conversion Load** turned off, a single sample will correspond to each key zone, meaning that a maximum of four multisamples will be used to create a key map in the velocity order of each key group. Also, key zones will not be crossfaded.

- When you load Program file data, settings such as key group, key group zone, oscillator, pitch, filter, amp/pan, and EG are supported, and can be converted into a NAUTILUS program, or programs + combination.
- When you load a Volume, all Program files and Sample files included in the Volume can be loaded together.
- AKAI S1000/S3000 format stereo Sample files and Program files whose names end in “-L” and “-R” can be loaded into the NAUTILUS as stereo samples and multisamples.

When the above files are loaded, “-L” and “-R” will automatically be moved to the end of the sample name or multisample name (23 and 24 character) so that they can automatically be recognized as stereo samples or multisamples.

Load AKAI Sample File



The selected Sample will be loaded as a sample.

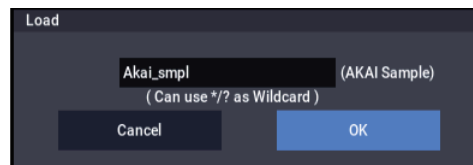

1. To load the data, press the OK button. To cancel without loading, press the Cancel button.

The sample will be loaded after the last sample that currently exists in SAMPLING mode (similar to loading with the Append option). If you save the data, it will be stored in Korg format. It is also possible to export as a .AIF or .WAV file; see “Export Samples as AIF/WAV”.

Note: You can load multiple files within the directory. (See “Multiple Select” on page 698, “Loading multiple files at once” on page 713)

 If the data that is loaded as a sample contains a loop point, you can set **Start Offset** (PROGRAM2-1c) on the NAUTILUS so that the sound will begin from the loop point.

Note: If the end (19 and 20 characters) of the sample name is “-L” and “-R,” the “-L” and “-R” will automatically be moved to the end of the NAUTILUS’s sample name (23 and 24 characters).

When you load two files whose sample names are identical except for ending in “-L” and “-R,” and assign them to a stereo multisample in SAMPLING mode, they will be recognized as a stereo sample.

Akai S1000/S3000 Loop Conversion

In rare cases, loops from Akai samples may need to be changed when loaded into the NAUTILUS:

- Some Akai samples may contain multiple loops. If this is the case, NAUTILUS will use the first HOLD loop, if present. If there is no HOLD loop, NAUTILUS will use the longest loop.
- Some Akai samples may have loop lengths with a resolution of less than a single sample. In this case, NAUTILUS will round the loop to the nearest sample.

Load AKAI Program File



The selected Program file will be loaded as a NAUTILUS program, or converted and loaded as programs + combination. You also have the option of loading only as multisamples and samples.

1. Select an AKAI Program file in the directory window.
2. Select the page menu command “Load selected” to open the dialog box.

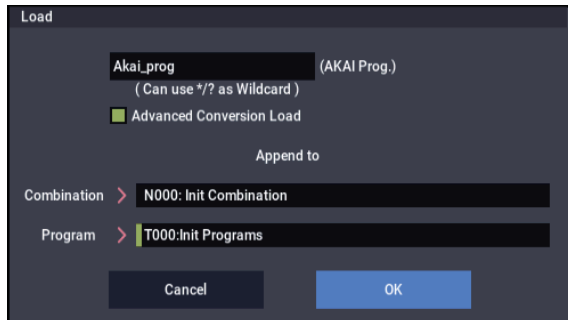

3. In “Advanced Conversion Load,” select how the AKAI Program file will be loaded.

On (checked): Program file parameters such as key group, key group zone, oscillator, pitch, filter, amp/pan, LFO, and EG will be converted into a NAUTILUS program or programs and combination.

Off (unchecked): The selected Program file will be loaded as a multisample. Only the keymap-related parameters within the Program file will be loaded to create the multisample.

4. If you checked “Advanced Conversion Load,” use “Append to: Combination” to specify the destination bank and number of the combination that will be created by the convert-load operation.

When you execute the command, the combinations that are created will be loaded starting at the bank and number you specify here.

5. If you checked “Advanced Conversion Load,” use “Append to: Program” to specify the destination bank and number of the program that will be created by the convert-load operation.

When you execute the command, the programs that are created will be loaded starting at the bank and number you specify here.

Note: The Multisamples and Samples will be loaded after the last Multisample and Sample currently existing in SAMPLING mode, like loading with the Append option.

Note: If the Sample files used by the Program file are not in the current directory or below it, a dialog box will appear, allowing you to specify the directory. For more information, see “If a file to be loaded cannot be found, or when loading a file that was saved across media” on page 704.

- Since sample RAM overflow checking is performed when loading each sample file, an overflow may occur during the loading process.

Note: If a loaded multisample is assigned samples whose sample names end in “-L” and “-R,” an “-L” and “-R” will automatically be added to the end (23 and 24 characters) of the multisample name.

Note: When you load two multisamples whose multisample names are identical except for ending in “-L” and “-R,” they will be recognized in SAMPLING mode as a stereo multisample.

- Depending on the structure of the AKAI Program, the data may be converted into two or more programs and one combination when it is loaded. In this case, the number of programs created is limited to a maximum of sixteen (the maximum number of programs usable in a combination), and the message “Exceeded 16 Programs” may appear. Please be aware of this when loading complex AKAI Program data.
- If the loading-destination bank and number exceed T127, loading will automatically stop.
- The data in the locations following the specified bank/number will be rewritten when you load. If you want to keep this data, use **Save All** or **Save PCG** before you load the AKAI Program data.

Load AKAI Volume



You can load Program files and Sample files in a single operation from a Volume on an AKAI S1000/S3000 format sample CD. On AKAI S1000/S3000 format sample CDs, the Program files and Sample files are organized into Partitions and Volumes (see “Files, directories, and icons” on page 695).

1. In the 0–1: Load page, use “Drive Select” to select the AKAI S1000/S3000 format media.
2. In the directory window, select the desired AKAI S1000/3000 format volume.
3. Select the page menu command “Load selected” to open the dialog box.

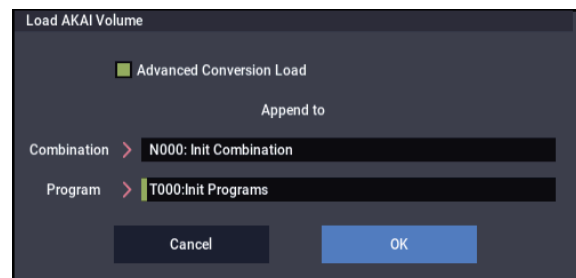

4. If you check “Advanced Conversion Load,” all Sample files included in the selected volume will be loaded as samples.

Program file settings such as key group, key group zone, oscillator, pitch, filter, amp/pan, and EG will be converted into a NAUTILUS program, or into programs and a combination. (Multisamples will also be converted-loaded.)



If you don’t check this, all Sample files included in the selected volume will be loaded as samples, and the Program file will be loaded as a multisample. Only the keymap-related parameters from the Program file will be loaded to create a multisample.

5. If you checked “Advanced Conversion Load,” use “Append to: Combination” to specify the destination bank and number of the combination that will be created by the convert-load operation.

When you execute the command, the combinations that are created will be loaded starting at the bank and number you specify here.

6. If you checked “Advanced Conversion Load,” use “Append to: Program” to specify the destination bank and number of the program that will be created by the convert-load operation.

When you execute the command, the programs that are created will be loaded starting at the bank and number you specify here.

-  If the loading-destination bank and number exceed T127, loading will automatically stop.
-  The data in the locations following the specified bank/number will be rewritten when you load. If you want to keep this data, use **Save All** or **Save PCG** before you load the AKAI Volume data.

Loading SoundFont 2.0 format files

SoundFont 2.0 is a file format that includes sound parameters with the sample data, and is widely supported in the multimedia field as well as by many software synthesizers and software samplers.

SoundFont 2.0 files may contain a number of different sounds—not just a single sound. When you load a SoundFont 2.0 file into the NAUTILUS, all of the file’s sounds will be loaded together.

Note: The entire file is always loaded. If you only want particular sounds from the SoundFont file, delete them before saving the KSC file to disk.

- Sound parameters such as key group, key group zone, oscillator, pitch, filter, amp/pan, LFO, and EG are supported, and will be converted to a NAUTILUS program or a combination and programs as they are loaded.
- Sample data will be converted into Multisamples and Samples, and loaded into SAMPLING mode.



Note: Multisamples, Programs, and Combinations are given the name of the SoundFont 2.0 file with a numbered suffix. When sounds are converted to Combinations, the Programs used in those Combinations will be given an asterisk (*) before the name.

If sample data that has the same settings is used in more than one item of sound data in a SoundFont 2.0 file, the sample data will be loaded into the first-loaded multisample, and will not be loaded into other multisamples. In such cases, please note that the program after loading will be assigned differently- named multisamples.

Note: If a loaded multisample assigns stereo samples, an “-L” and “-R” will be automatically added to the end of the multisample name and sample name (the 23rd and 24th characters).

Note: If two identical multisamples whose file names differ only by ending in “-L” and “-R” are loaded, SAMPLING mode will recognize them as a stereo multisample.

-  In some cases depending on the structure of the sound data, the data will be converted into multiple programs and one combination when you load it. In this case, the maximum number of programs following conversion is limited to the sixteen programs that a combination can use, and a message of “Exceeded 16 Programs - some data not loaded” may appear. Please be aware of this when loading complex sound data structures.

-  SoundFont 2.0 files may contain sound data that is assigned to use ROM sample data from a specific sound card. In this case, the sample data will not be included in the SoundFont 2.0 file, and so the sound will not play correctly.
-  SoundFont 2.0 files may contain sound data that is assigned to use effects from a specific sound card or sampler program. These effect settings will not be loaded.
-  SoundFont 2.0 files may use sample data of a sampling frequency not supported by the NAUTILUS. In this case, the Pitch parameter for each Index of the multisample will be set automatically in order to correct the playback pitch. Since the Pitch parameter is set in units of a cent, the pitch may not be accurate. If you use the loaded sample in another multisample or drum kit, you must use the multisample’s Pitch parameter or the drum kit’s Transpose and Tune parameters to adjust the pitch.

Load SoundFont 2.0 File



This command loads the selected SoundFont 2.0 file.

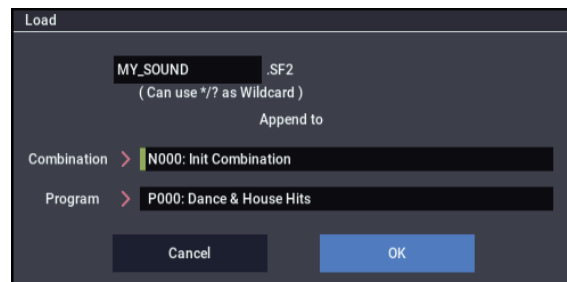

1. Use “Append to: Combination” to specify the destination bank and number of the combination that will be created by the convert-load operation.
When you execute this command, the created combination(s) will be loaded starting at the bank and number you specify here.
2. Use “Append to: Program” to specify the destination bank and number of the program that will be created by the convert-load operation.

When you execute this command, the created program(s) will be loaded starting at the bank and number you specify here.

Note: The Multisamples and Samples will be loaded after the last Multisample and Sample currently existing in SAMPLING mode, like loading with the Append option.

-  Since an overflow check for the user sample RAM is performed when loading each individual sample file, it is possible for an overflow to occur during the load operation.

Loading DX format .SYX

The NAUTILUS can load sounds created for the vintage Yamaha DX7. These sounds will be converted into MOD-7 Programs. For more information, please see “Loading DX sounds” on page 300.

Load DX Program Bank .SYX file

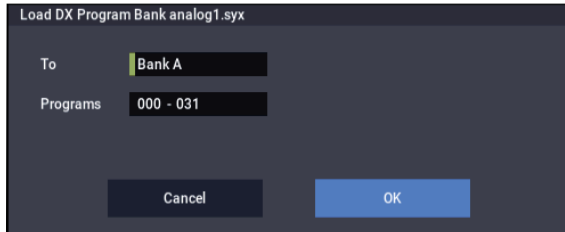

Load PCG (RAM) and Samples

Load PCG (RAM) and Samples loads only the Programs, Wave Sequences, and Drum Kits that use SAMPLING mode data, as well as the Combinations or Songs that use these Programs. This is useful when you are editing Programs and Combinations that use SAMPLING mode data.

Optionally, you can also load all the Programs used by the loaded Combinations and Songs, even if they don't use SAMPLING mode data.

The Programs and Combinations will be loaded in order from the bank and number you specify.

Content loaded from the .PCG file

This command loads:

- Drum Kits or Wave Sequences which use at least one SAMPLING mode Sample or Multisample.
- Programs which use at least one SAMPLING mode Multisample, or one Drum Kit or Wave Sequence as described above.
- Combinations which use at least one Program as described above.

Content loaded from the .SNG file

The command also loads Songs which use at least one Program as described in (2), above.

These Songs will be loaded into vacant numbers starting after the last Song in internal memory. For more information, see “.SNG Allocation” on page 705.

Automatic reassignment of banks and numbers

When loading, the banks and numbers for all data will be adjusted automatically so that all references work correctly. This includes:

- SAMPLING mode Samples used by Multisamples and Drum Kits
- SAMPLING mode Multisamples used by Programs and Wave Sequences
- Drum Kits and Wave Sequences used by Programs
- Programs used by Combinations or Songs

1. Select a .PCG file in the directory window.

2. Select this command to display the dialog box.

This command will be available only if you've selected a .PCG file.

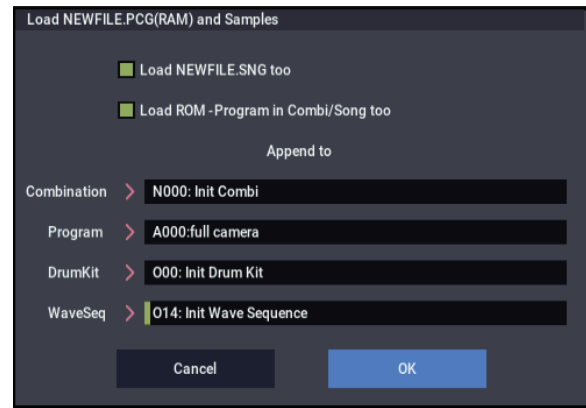

3. If you also want to load the .SNG file of the same name as the .PCG file, check the “Load *****.SNG too” check box.

Note: The .KSC file of the same filename as the .PCG file will be loaded together with the .PCG file. If the file does not exist in the current directory, load the file as described in “If a file to be loaded cannot be found, or when loading a file that was saved across media” on page 704.

4. If you check “Load ROM-Program in Combi/Song too,” ROM-based programs in the .PCG file combinations or .SNG file songs will be loaded together with the Programs which use SAMPLING mode data.

Choose this setting if the Combinations or Songs being loaded rely on both user and preload Programs. This is the default.

If you leave this unchecked, only Programs, Drum Kits, and Wave Sequences which use SAMPLING mode data will be loaded, along with any Combinations or Songs which use those Programs.

(To ensure that those Combinations and Songs sound correctly, all Programs that they require will also be loaded, even if they use only ROM data.)

⚠ Program data whose bank type is EXi will not be loaded.

5. Use “Append to: Combination” to specify the loading-destination bank and number for the combinations in the .PCG file.

When you execute, only the applicable combinations will be loaded into consecutive numbers starting at the bank and number you specify here.

6. Use “Append to: Program” to specify the loading-destination bank and number of the programs in the .PCG file.

When you execute, only the applicable programs will be loaded into consecutive numbers starting at the bank and number you specify here.

If the loading-destination bank and number exceed N127, loading will automatically stop.

⚠ If the load-destination bank and number in steps 5 and 6 exceeds USER-G127, the load operation will end automatically.

7. Use “Append to: Drum Kit” to specify the loading-destination number for the drum kits in the .PCG file.

When you execute, only the applicable drum kits will be loaded into consecutive numbers starting at the number you specify here.

- Use the **Append to “Wave Sequence” field to specify the load-destination number for the wave sequences in the .PCG file.**

When you execute the command, only the valid wave sequences will be loaded starting at the number you specify, and occupying each consecutive number.

- If the load-destination bank and number in steps 7 and 8 exceeds O15, O31 respectively, the load operation will end automatically.
 - The data in the locations following the specified bank/number will be rewritten when you load. If you want to keep this data, use **Save All** or **Save PCG** before you load the new data.
- Press the **OK** button to load the data. If you decide not to load, press the **Cancel** button.

0-2: Save Page Menu Command

Cautions regarding Save

- When saving combinations with **Save All**, **Save PCG & SNG**, or **Save PCG**, you should also try to save the programs used by each timbre (and the drum kits, wave sequences used by the programs) at the same time.

Similarly, when saving programs, you should also save the drum kit, wave sequence used by the program and the wave sequence at the same time.

- If multisamples or samples created in **SAMPLING** mode are used in a program or drum kit, we recommend that you save the data using **Save All**.

Also when using **Save PCG** or **Save Sampling Data** to save an individual program, drum kit, or multisample or sample created in **SAMPLING** mode, we recommend that you save the data in the same directory with the same filename.

When using **Load PCG** to load a .PCG file, the .KSC file of the same name will be loaded at the same time so that the multisamples/samples that were saved with the program or drum kit will correspond correctly.

If the data being saved does not fit on one volume of media

When saving a .PCG, .KSC, .KMP, or .KSF file, and the data does not fit on one volume of media, the display will ask “No space available on medium. Do you want to make a divided file?” Save your data to media that has more available space.

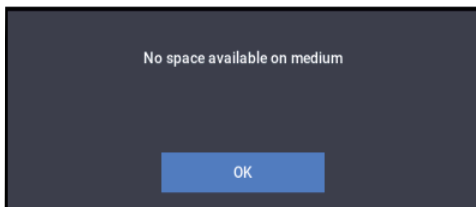

Save All (PCG, SNG and KSC)

Save All lets you save all of the internal data to disk in a single step, including:

.PCG file: Programs, combinations, drum kits, Arpeggio Pattern, wave sequences, global settings

.SNG file: Songs, region data

.KSC file: References to Multisamples, Samples, and Drum Samples from **SAMPLING** mode, EXs, or User Sample Banks

This command is valid only when the current directory is a DOS directory. If you are browsing inside a .PCG, .SNG, or .KSC file, for instance, the menu command will be grayed out.

- Select **Save All** to open the dialog box.

Save All (PCG, SNG and KSC)

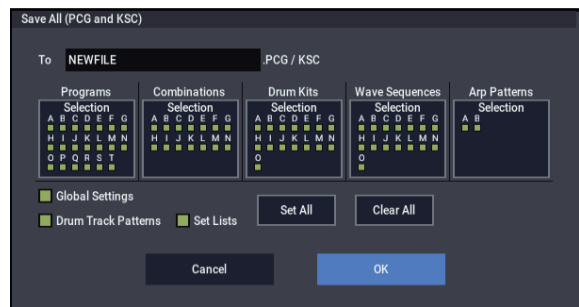

- Use the text edit button to open the text edit dialog box, and set the name as desired.

The name will be shared by all of the saved files, each with its own three-letter extension. For example, the name “NewFile” will result in files named NewFile.PCG, NewFile.SNG, and NewFile.KSC.

If a USB QWERTY keyboard (commercially available) is connected, you can use this to enter text instead of the on-screen keyboard. For more information, see “Editing names and entering text” on page 206 of the OG.

- Select the bank(s) that you want to save.

Programs, combinations, drum kits, wave sequences, and Arpeggio Pattern can be saved in units of banks.

Information on the bank to be saved is displayed below each Selection button. Banks that are checked will be saved.

If you want to modify the selections, press the Selection button to open the dialog box, and check the check boxes for the data you want to save.

Example: when the Selection button for Program is pressed

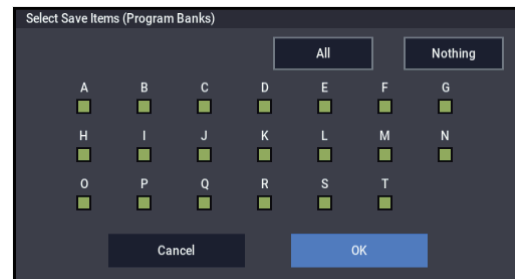

If you press the **All** button, all banks will be checked.

If you press the **Nothing** button, all banks will be unchecked.

Press the OK button to change the selections as specified, or press the Cancel button to discard your changes.

To specify whether “Global Settings” will be saved, use the check box in step 1.

4. To save the data, press the OK button. To cancel without saving, press the Cancel button.

If the error message “No space available on medium” appears, see “If the data being saved does not fit on one volume of media” on page 720.

When you save, files will be created in the current directory. If the data you save extends across two or more media, these files will be divided. In addition to the .PCG, .SNG, and .KSC files that will be created with the specified filename, one directory will also be created. The files listed in NEWFILE.KSC will be saved in this directory.

In addition to the .PCG, .SNG, and .KSC files created with the specified filename, two directories will also be created.

 One directory will have the “specified filename” as its directory name, and will contain the files listed in .KSC. (File: purple)

 The other directory will have “(specified filename)_A” as its directory name, and will contain the WAVE files used by the regions of each audio track in each song. (File: red)

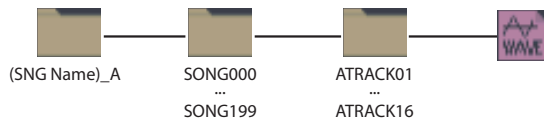

Save PCG & SEQ

This command saves all internal memory programs, combinations, drum kits, wave sequences, and global settings as a .PCG file, and saves songs and regions data to a .SNG file on the specified media.

This command is valid only when the current directory is a DOS directory. If you are browsing inside a .PCG, .SNG, or .KSC file, for instance, the menu command will be grayed out.

1. Select “Save PCG & SEQ” to open the dialog box.

Save PCG & SEQ Data

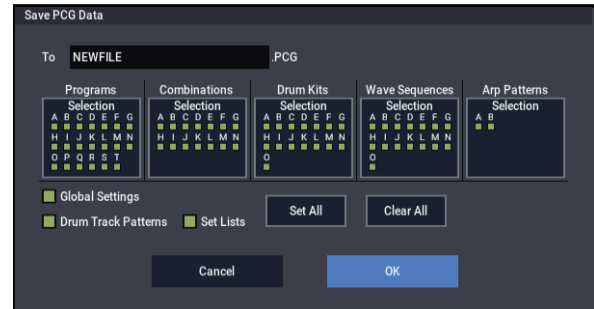

2. Use the text edit button to open the text edit dialog box, and set the name as desired.

The name will be shared by all of the saved files, each with its own three-letter extension. For example, the name “NewFile” will result in files named NewFile.PCG, and NewFile.SNG.

If a USB QWERTY keyboard (commercially available) is connected, you can use this to enter text instead of the on-screen keyboard. For more information, see “Editing names and entering text” on page 206 of the OG.

3. Select the bank(s) that you want to save.

For more information, see “Save All (PCG, SNG and KSC)” on page 720.

4. To save the data, press the OK button. To cancel without saving, press the Cancel button.

A directory will be created in addition to the .PCG and .SNG files created with the specified filename.

 The directory will have “(specified filename)_A” as its directory name, and will contain the WAVE files used by the regions of each audio track in each song. (File: red)

Note: Some Global settings are not saved, including:

- Memory Protect settings
- System Clock setting

Save PCG

This command saves all internal memory programs, combinations, drum kits, wave sequences, and global settings as a .PCG file.

This command is valid only when the current directory is a DOS directory. If you are browsing inside a .PCG, .SNG, or .KSC file, for instance, the menu command will be grayed out.

1. Select “Save PCG” to open the dialog box.

Save PCG Data

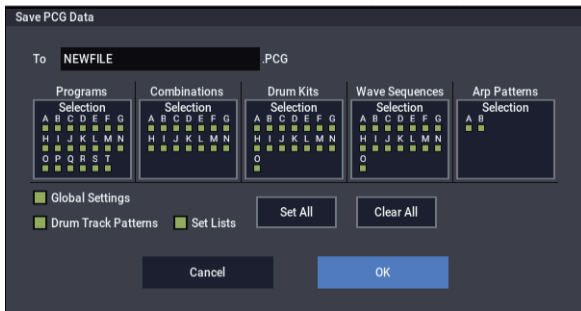

2. Use the text edit button to open the text edit dialog box, and set the name as desired.

The extension “.PCG” will be added automatically. For example, the name “NewFile” will result in a file named NewFile.PCG.

If a USB QWERTY keyboard (commercially available) is connected, you can use this to enter text instead of the on-screen keyboard. For more information, see “Editing names and entering text” on page 206 of the OG.

3. Select the bank(s) that you want to save.
For more information, see “Save All (PCG, SNG and KSC)” on page 720.
4. To save the data, press the OK button. To cancel without saving, press the Cancel button.

Save SEQ

This command saves all songs and regions data from internal memory as a .SNG file.

This command is valid only when the current directory is a DOS directory. If you are browsing inside a .PCG, .SNG, or .KSC file, for instance, the menu command will be grayed out.

1. Select “Save SEQ” to open the dialog box.

Save Songs and Regions Data

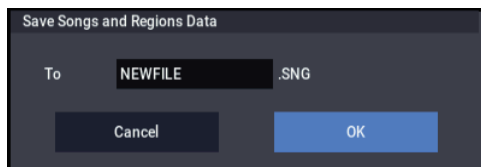

2. Use the text edit button to open the text edit dialog box, and set the name as desired.

The extension “.SNG” will be added automatically. For example, the name “NewFile” will result in a file named NewFile.SNG.

If a USB QWERTY keyboard (commercially available) is connected, you can use this to enter text instead of the on-screen keyboard. For more information, see “Editing names and entering text” on page 206 of the OG.

3. To save the data, press the OK button. To cancel without saving, press the Cancel button.

A directory will be created in addition to the .SNG file created with the specified filename.



The directory will have “(specified filename)_A” as its directory name, and will contain the WAVE files used by the regions of each audio track in each song. (File: red)

Save Sampling Data

This command lets you save any or all of the data from SAMPLING mode (either created through sampling, or previously loaded from disk), the current set of loaded EXs and User Sample Bank data, or both. In most cases a .KSC file is also created; see “What’s a KSC file?” below.

Save Sampling Data is valid only when the current directory is a DOS directory. If you are browsing inside a .PCG, .SNG, or .KSC file, for instance, the menu command will be grayed out.

SAMPLING mode Multisamples and Samples are saved as Korg format .KMP and .KSF files, respectively.

What’s a KSC file?

KSC stands for Korg Sample Collection. .KSC files contain links to SAMPLING mode, EXs, and/or User Sample Bank data, including Multisamples, Samples, and Drum Samples. Loading a .KSC file loads all of the linked data.

If a .KSC includes links to SAMPLING mode data, other .KSC files can link to *that* .KSC as a User Sample Bank.

Saving SAMPLING mode data creates two KSC files

When you save a KSC which includes SAMPLING mode data, two KSC files are created:

- A KSC with the name you’ve specified, which includes the actual Samples and Multisamples from SAMPLING mode.
- A second KSC which includes links to the first KSC’s SAMPLING mode Data, with Load Method set to Virtual Memory. The name for this KSC is the name you’ve specified followed by the text “_UserBank.” For instance, if the first KSC is named BillGig.KSC, the second will be BillGig_UserBank.KSC. This is the file that you’ll load to access the sample data as a User Sample Bank.

Both files may contain references to other EXs or User Sample Banks, depending on the setting of the **Include** parameter in the Save dialog.

For more information on User Sample Banks, see “User Sample Banks” on page 151 of the OG.

Using Save Sampling Data

1. Select “Save Sampling Data” to open the dialog box.

Save Multisample and Sample Data

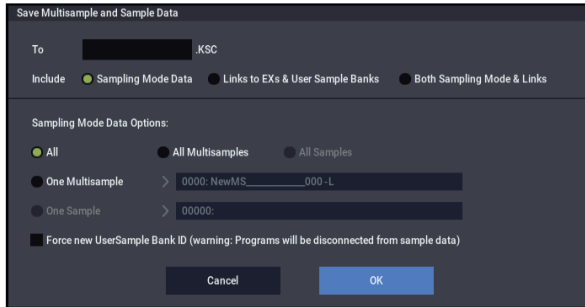

2. Use the text edit button to open the text edit dialog box, and set the name as desired.

If a USB QWERTY keyboard (commercially available) is connected, you can use this to enter text instead of the on-screen keyboard. For more information, see “Editing names and entering text” on page 206 of the OG.

3. Use “Include” to specify whether to save SAMPLING mode data, references to EXs and User Sample Banks, or both.

4. Under “User Sample Data options,” specify which parts of the SAMPLING mode data will be saved. Use the following five radio buttons to make your selection.

All: This is the default; it saves all Multisamples and Samples from SAMPLING mode (as .KMP and .KSC files, respectively), inside a directory with the name entered above. KSC files are also created, as described under “Saving SAMPLING mode data creates two KSC files,” above.

All Multisamples: Only the Multisamples from SAMPLING mode, along with any Samples that they use, will be saved (as .KMP and .KSC files, respectively) inside a directory with the name entered above. Any Samples not used by Multisamples will not be saved. KSC files are also created, as described under “Saving SAMPLING mode data creates two KSC files,” above.

All Samples: All samples will be saved as .KSF files, inside a directory with the name entered above. KSC files are also created, as described under “Saving SAMPLING mode data creates two KSC files,” above.

One Multisample: The selected Multisample will be saved as a .KMP file. Simultaneously, a directory will also be created, and the Samples used by the Multisample will be saved in that directory.

The names of both the file and the directory will be set to the first five characters (uppercase) of the sixteen-character Multisample name, followed by the Multisample number. If the Multisample number is greater than 999, only the first four characters will be used. For example:

000: NewMS_0000 → NEWMS000.KMP

001: 108bpmDrLoop00 → 108BP001.KMP

One Sample: The selected sample will be saved as a .KSF file.

The filename will automatically be set to the first four characters (uppercase) of the sixteen-character Sample name, followed by the Sample number. If the number is

greater than 9,999, only the first three characters will be used. For example:

0000: NewSample_0000 → NEWS0000.KSF

0001: C#3-EGuitar → C#3-0001.KSF

Note: If you wish to export the data in AIFF (.AIF) or WAVE (.WAV) format, use the menu command **Export Samples as AIF/WAV** instead.

5. In general, leave “Force new User Sample Bank ID” un-checked.

This should be used only in special cases.

For instance, you might use **Force new User Sample Bank ID** if you have loaded a User Sample Bank, edited it substantially, and wish to save the result as a totally new User Sample Bank. After doing so, you’ll also need to use the Remap MS/Sample Bank References menu command to assign Programs, Wave Sequences, or Drum Kits to use the new bank instead of the old one.

For more information, see “User Sample Bank IDs” on page 156 of the OG.

6. To save the data, press the OK button. To cancel without saving, press the Cancel button.

Note: If the **Translation** menu command is enabled, .KMP and .KSF files will be shown with their full sixteen-character Multisample or Sample names, as opposed to the abbreviated 8.3-character file names.

Save to Standard MIDI File

This command saves the selected song from internal memory to storage media as a .MID file (Standard MIDI File).

Save to Standard MIDI File is valid only when the current directory is a DOS directory. If you are browsing inside a .PCG, .SNG, or .KSC file, for instance, the menu command will be grayed out.

Note: This applies only to MIDI track data. Audio track data will not be saved.

1. Select “Save to Standard MIDI File” to open the dialog box.

Save Song as Standard MIDI File

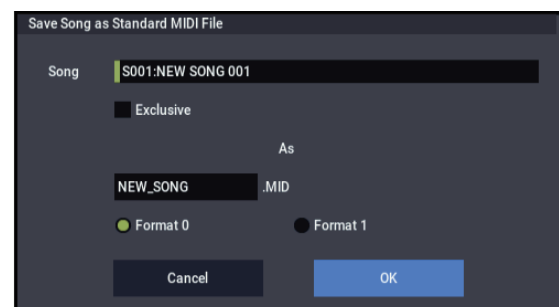

2. In Song, select the Song that you wish to save.

3. If “Exclusive” is On (checked), System Exclusive events and Universal Exclusive events included in the song data will be saved as exclusive messages.

If this is Off (unchecked), system exclusive events and universal exclusive events included in the song data will not be saved.

4. Use the text edit button to open the text edit dialog box, and set the name as desired.

By default, the name will be the first eight characters of the song name, in uppercase.

If a USB QWERTY keyboard (commercially available) is connected, you can use this to enter text instead of the on-screen keyboard. For more information, see “Editing names and entering text” on page 206 of the OG.

5. Use the radio buttons to specify the format.

Format 0 will save sixteen channels of MIDI data together in a single track.

Format 1 will save each MIDI channel to a separate track.

6. To save the data, press the OK button. To cancel, press the Cancel button.

The song data (MIDI track data) you save here can be played back on a device that supports Standard MIDI Files. However if you intend to playback the data on the NAUTILUS, we recommend that you use “Save SEQ” to save the data, since this will allow a higher degree of reproducibility.

Save Exclusive

This command first captures incoming MIDI System Exclusive data (SysEx), and then saves the data as an .EXL file.

Save Exclusive is valid only when the current directory is a DOS directory. If you are browsing inside a .PCG, .SNG, or .KSC file, for instance, the menu command will be grayed out.

1. When you select “Save Exclusive,” the NAUTILUS will wait for incoming MIDI SysEx data. The following dialog box will appear.

Receive and Save MIDI System Exclusive Data

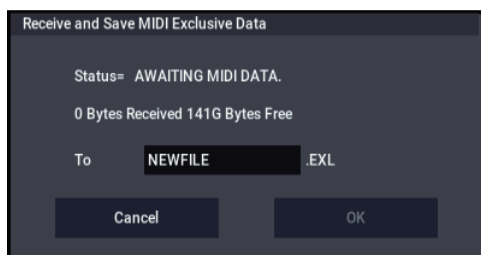

2. Transmit the exclusive data that you wish to save to the NAUTILUS.

While the data is being received, the display will indicate “Status=RECEIVING MIDI DATA.” When reception ends, the size of the received data and the size of the remaining free area will be rewritten. The display will change to “Status=AWAITING MIDI DATA,” and you can continue transmitting exclusive data to the NAUTILUS. During reception, the Cancel button and the OK button cannot be pressed.

3. Use the text edit button to open the text edit dialog box, and set the name as desired.

If a USB QWERTY keyboard (commercially available) is connected, you can use this to enter text instead of the on-screen keyboard. For more information, see “Editing names and entering text” on page 206 of the OG.

4. To save the data, press the OK button. To cancel without saving, press the Cancel button.

Save Effect Preset

Effect preset data will be saved to disk as a .KFX file.

This command is valid only when the current directory is a DOS directory. If you are browsing inside a .PCG, .SNG, or .KSC file, for instance, the menu command will be grayed out.

1. Select “Save Effect Preset” to open the dialog box.

Save Effect Preset

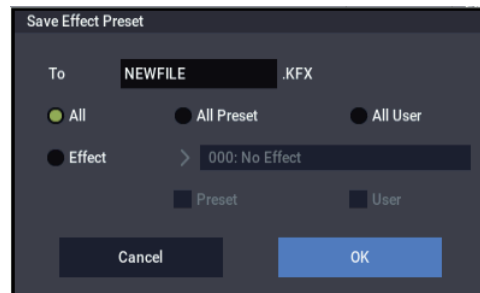

2. Use the text edit button to open the text edit dialog box, and set the name as desired.

The extension “.KFX” will be added automatically. For example, the name “NewFile” will result in a file named NewFile.KFX.

If a USB QWERTY keyboard (commercially available) is connected, you can use this to enter text instead of the on-screen keyboard. For more information, see “Editing names and entering text” on page 206 of the OG.

3. Specify the contents that will be saved. Choose one of the following five radio buttons.

All: All preset data (P01–P15 and U00–U15) for all effects will be saved.

All Preset: Preset data P01–P15 for all effects will be saved.

All User: Preset data U01–U15 for all effects will be saved.

One Effect: Only the preset data of the selected effect will be saved. If you check Preset, P01–P15 will be saved; if you check User, U01–U15 will be saved.

4. Press the OK button to save the data, or press the Cancel button to cancel without saving.

Export Samples as AIF/WAV

SAMPLING mode data can be exported to disk as AIFF or WAVE format sample files.

This command is valid only when the current directory is a DOS directory. If you are browsing inside a .PCG, .SNG, or .KSC file, for instance, the menu command will be grayed out.

Note: Normally, it is recommended that you use Save All or Save Sampling Data to save sample data in Korg format (.KSC, .KMP, .KSF). This preserves all of the parameters of the Multisamples and Samples for use in Programs, Wave Sequences, and Drum Kits.

Use **Export Samples as AIF/WAV** if you wish to use an AIFF or WAVE format compatible application on your computer to work with samples that were recorded or edited on the NAUTILUS.

Export Samples as AIF/WAV does not export multisample files. The exported AIFF or WAVE format samples can be re-loaded, but if the sample number when saving is different than the sample number when loading, you may need to re-make certain settings, such as selecting the sample for each index of a multisample.

Furthermore, the following sample parameters are not preserved when using **Export Samples as AIF/WAV**:

- Sample Name
- Loop Tune (see “Loop Tune” on page 590)
- Reverse (see “Reverse” on page 590)
- +12dB (see “+12dB” on page 590)

Stereo samples will be exported as two independent L and R files.

1. Select “Export Samples as AIF/WAV” to open the dialog box.

Export Samples as AIFF/WAVE



2. In “Format,” select either AIFF or WAVE as the file format for export.

3. Use the text edit button to open the text edit dialog box, and set the name as desired.

If a USB QWERTY keyboard (commercially available) is connected, you can use this to enter text instead of the on-screen keyboard. For more information, see “Editing names and entering text” on page 206 of the OG.

4. In “To,” specify the content that will be exported.

All Samples: All samples will be exported.

Filenames will automatically be set to the first four characters (uppercase) of the sixteen-character Sample name, followed by the Sample number. If the number is greater than 9,999, only the first three characters will be used. For example:

0000: NewSample_0000→NEWS0000.AIF

0001: C#3-EGuitar→C#3-0001.WAV

Samples in One MS: All samples used by the selected multisample will be exported.

Filenames will automatically be set to the first five characters (uppercase) of the sixteen-character Multisample name, followed by the index number of the Sample within the Multisample (001-128). For example:

000: NewMS_000:

Sample selected for index 001 → MS000001.AIF

Sample selected for index 002 → MS000002.AIF

001: 108bpmDrLoop00:

Sample selected for index 001 → MS001001.AIF

Sample selected for index 002 → MS001002.AIF

When exporting All Samples or Samples in One MS, and all of the sample data does not fit on one volume of media, another dialog box will appear, directing you to specify the next media. (See “If the data being saved does not fit on one volume of media” on page 720.) However at this time if a single sample is larger than the capacity of the media, the sample cannot be exported. Either specify media with a larger capacity, or press Skip button to omit exporting that sample and proceed to exporting the next sample.

One Sample: The single selected sample will be exported.

The filename will automatically be set to the first four characters (uppercase) of the sixteen-character Sample name, followed by the Sample number. If the number is greater than 9,999, only the first three characters will be used.

When exporting One Sample, it is not possible to export sample data that will not fit on one volume of media.

5. To export the data, press the OK button. To cancel without exporting, press the Cancel button.

0-3: Utility Page Menu Command

Rename

This command renames the selected file or directory.

Rename is valid only when a DOS file or a DOS directory is selected. If you are browsing inside a .PCG, .SNG, or .KSC file, for instance, the menu command will be grayed out.

1. Select the file or directory whose name you want to edit.
2. Select “Rename” to open the dialog box.

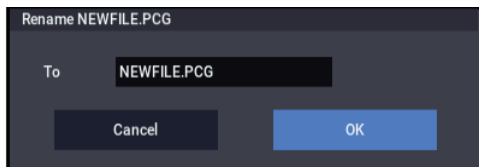

3. Use the text edit button to open the text edit dialog box, and set the name as desired.

If a USB QWERTY keyboard (commercially available) is connected, you can use this to enter text instead of the on-screen keyboard. For more information, see “Editing names and entering text” on page 206 of the OG.

4. To rename the file or directory, press the OK button. To cancel, press the Cancel button.

Copy

Copy is valid only when a DOS file or a DOS directory is selected. If you are browsing inside a .PCG, .SNG, or .KSC file, for instance, the menu command will be grayed out.

1. Select the file or directory that you want to copy.

If **Multiple Select** is enabled, you can select more than one file and copy them in a single operation.

2. Select “Copy” to open the dialog box.



3. “Copy” will show the name of the selected file or directory.

If you wish to change the file or directory that will be copied, use the text edit button to open the text edit dialog box, and enter the filename that you wish to copy.

You can also use wildcards to copy multiple files at once; for more information, see “Using wildcards,” below, and “Loading multiple files at once” on page 713.

4. Use the Open button and Up button to select the copy destination directory.

If you wish to specify a different USB device, use “Drive Select” (0-1a) to select it.

5. If you wish to change the name of the newly copied file or directory, use the text edit button (in the lower line) to open the text input dialog box, and enter the new name.

You can’t change the filenames if you’re using wildcards or **Multiple Select** to copy two or more files simultaneously.

If a USB QWERTY keyboard (commercially available) is connected, you can use this to enter text instead of the on-screen keyboard. For more information, see “Editing names and entering text” on page 206 of the OG.

6. To copy the data, press the OK button. To cancel without copying, press the Cancel button.

If the drive that you selected in “Drive Select” is a removable disk (floppy disk, CD-R/RW, MO disc, removable hard disk etc.), it is not possible to copy to different media on the same drive.

Using wildcards

(Can use */? as Wildcard): When you use the text edit dialog box to specify the name of the file to be copied, you can use “*” and “?” characters as wildcards.

“*” designates zero or more characters of any kind. For instance, if in the above example you enter PRELOAD1.* instead of PRELOAD1.PCG, all filenames starting with “PRELOAD1.” will be copied at the same time, regardless of their file extension: i.e., PRELOAD1.PCG, PRELOAD1.SNG, PRELOAD1.KSC, etc.

“?” designates a single character. For instance, if you enter PRELOAD?.PCG, all PCG files whose names start with “PRELOAD” followed by any single character will be copied : i.e., PRELOAD1.PCG, PRELOAD2.PCG, PRELOAD3.PCG, etc.

- When wildcards are used, only files will be copied. Directories will not be copied.

Delete

This command deletes the selected file or directory.

Delete is valid only when a DOS file or a DOS directory is selected. If you are browsing inside a .PCG, .SNG, or .KSC file, for instance, the menu command will be grayed out.

1. Select the file or directory that you want to delete.

If **Multiple Select** is enabled, you can select more than one file and delete them in a single operation.

2. Select “Delete” to open the dialog box.

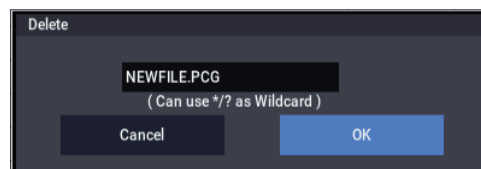

3. “Delete” will show the name of the selected file or directory.

If you wish to change the file or directory that is to be deleted, use the text edit button to open the text edit dialog box, and specify the name of the file or directory that you wish to delete.

(Can use */? as Wildcard): When you use the text edit dialog to specify the name of the file to be deleted, you can use the “*” or “?” characters as wildcards. This

allows you to simultaneously delete multiple files with identical filenames and different extensions, or files whose names are partially identical. For more information, see “Using wildcards,” above.

When wildcards are used, only files will be subject to deletion. Directories will not be deleted.

- To delete the selected file or directory, press the **OK button**. To cancel without deleting, press the **Cancel button**.

Delete Unused WAV Files

This command operates on an .SNG file selected in the file browser. It searches the .SNG’s audio directory for WAV files which are not used in any of the .SNG’s Songs (such as discarded audio takes), and then deletes those files along with any related region data.

This can be useful to free up space on your disk.

If an .SNG file is not selected, the menu command is unavailable.

For more information on .SNG audio directories, see “How audio data is stored on the internal drive” on page 92 of the OG.

- Select the .SNG file for which you want to delete unused sounds.
- Select the “Delete Unused WAV Files” menu command.

The Delete Unused WAV Files dialog will appear.

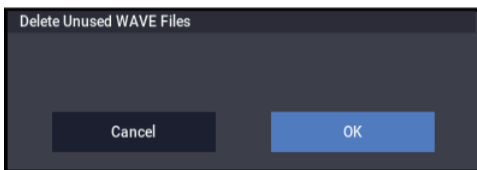

- To delete the unused WAV files, press the **OK button**. To cancel without affecting any files, press the **Cancel button**.

Once you press OK, the deletion is permanent and cannot be undone. Executing Page menu command “Compare” will have no effect.

Create Directory

This command creates a new directory within the current directory.

Create Directory is valid only when the current directory is a DOS directory. If you are browsing inside a .PCG, .SNG, or .KSC file, for instance, the menu command will be grayed out.

- Select “Create Directory” to open the dialog box.

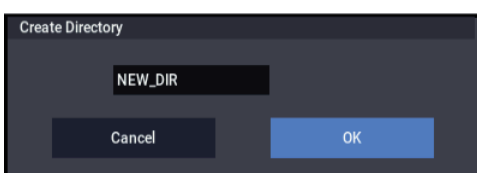

- Use the text edit button to open the text edit dialog box, and set the name as desired.

If a USB QWERTY keyboard (commercially available) is connected, you can use this to enter text instead of the on-screen keyboard. For more information, see “Editing names and entering text” on page 206 of the OG.

- To create the directory, press the **OK button**. To cancel without creating the directory, press the **Cancel button**.

Set Date/Time

This command sets the date and time of the NAUTILUS’s internal calendar.

- Select “Set Date/Time” to open the dialog box.

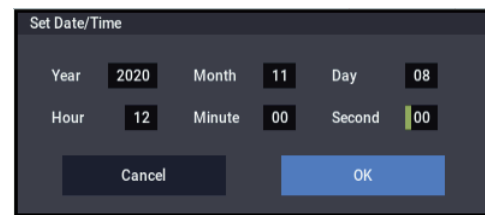

- Set each parameter.

“Year” 1980–2037

“Month” 1–12

“Day” 1–31

“Hour” 0–23

“Minute” 0–59

“Second” 0–59

- To set the date and time, press the **OK button**. To cancel, press the **Cancel button**.

Format

This command formats the selected media. The volume label (a name for the entire media) you specify will be assigned to the media. The volume label you assign here will be displayed in “Drive Select” (0–1a). The volume label can be a maximum of eleven characters.

When you format, all data saved on that media will be erased. If you had used a computer etc. to set up that drive so that it can be used as multiple drives (partitions), this data will also be erased. Be sure to double-check before you format.

After formatting, it is not possible to execute Page menu command “Compare” to return to the previous state.

- Make sure that the media you want to format is inserted.
- Use “Drive Select” to select the media that will be formatted.
- Select “Format” to open the dialog box.

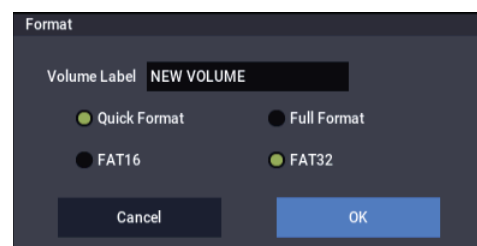

- In “Volume Label,” use the text edit button to open the text input dialog box, and set the name as desired.

The previously-specified volume label will be displayed. If no volume label had been specified for the media, or if a non-DOS media was inserted, this will indicate “NEW VOLUME.”

If a USB QWERTY keyboard (commercially available) is connected, you can use this to enter text instead of the on-screen keyboard. For more information, see “Editing names and entering text” on page 206 of the OG.

5. Specify the initialization format.

Quick Format: Normally you should use Quick Format to initialize the media.

Select this if the media has already been physically formatted, or if you want to format media that has been UDF-formatted by the NAUTILUS. Since only the system area of the media need be formatted, this will require less time.

Full Format: Select this when formatting media that has not been physically formatted, or media (CD-RW) that has not been UDF-formatted.

Note: For the internal drive you can only select “Quick Format.” Also, the file system selection of FAT16 or FAT32 in step 6 is not available.

Note: Normally, it is not necessary to perform a Full Format on media that has already been physically formatted. Execute the Quick Format for such media.

Note: You will normally select Full Format for CD-RW media etc. that has not been UDF-formatted. If an error message of “Media not formatted” appears, execute Full Format. Depending on the capacity of the media, executing Full Format may require a substantial length of time.

6. Specify the file system.

FAT16 can format a maximum of 4 Gigabytes. If you are using media larger than this., use FAT32 format instead. (FAT32’s theoretical maximum is 2 Terabytes, or 2,000 Gigabytes.)

7. To format the media, press the OK button. To cancel without formatting, press the Cancel button.

Note: If you want to use a CD-R/RW for writing packet data, you must format it. If you will be using it as an audio CD, formatting is not necessary.

Convert to ISO9660 Format

This command converts UDF format CD-R media to ISO9660 format.

If a file that was saved by the NAUTILUS to CD-R is to be loaded by another device, you must execute this command to convert it to ISO9660 format.

This conversion temporarily uses memory space on the drive.

1. Select “Convert to ISO9660 Format” to open the dialog box.

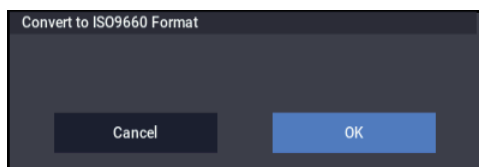

2. Press the OK button to execute the conversion, or press the Cancel button to cancel without executing.

 Even if data is converted into ISO9660 format, some files may not be readable by certain devices.

Rate Convert

This command converts the sampling rate (frequency) of the selected WAVE file from 48 kHz to 44.1 kHz or 44.1 kHz to 48 kHz.

This is valid only when a 48 kHz or 44.1 kHz WAVE file is selected.

- 1. Select the file or directory whose sampling rate (frequency) you want to convert.**
- 2. Select “Rate Convert” to open the dialog box.**



“Rate Convert” will indicate the name of the selected file.

3. Use the Open button and Up button to select the save-destination directory.

If you want to specify another USB device, use “Drive Select” to specify it.

4. If you want to change the filename for saving, press the text edit button in the lower line to open the text edit dialog box, and set the name as desired.

If a USB QWERTY keyboard (commercially available) is connected, you can use this to enter text instead of the on-screen keyboard. For more information, see “Editing names and entering text” on page 206 of the OG.

5. Press the OK button to execute the Rate Convert command, or press the Cancel button to cancel without executing.

Check Medium

This command checks the selected storage media for errors, and corrects any errors if possible. Use **Check Medium** if you frequently experience messages such as “Error in writing to medium” while saving files, or “Buffer overrun error occurred” while sampling to disk.

- 1. Use “Drive Select” to select the media that you want to check.**
- 2. Select “Check Medium” to open the dialog box.**

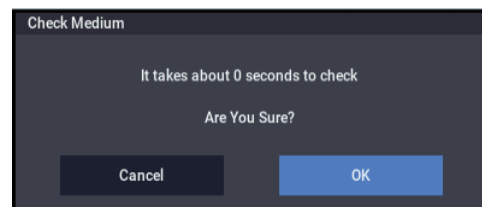

The dialog includes a rough estimate of the time required to complete the process for the selected media. The actual time required will vary depending on the speed and capacity of the media, as well as the number of errors that are found.

3. Press the OK button to start checking the media, or press the Cancel button to cancel.
4. When process has been completed, the recovered content will be displayed.

Note: If you want to stop the checking process before it has been completed, press the Abort button.

Install EXs

This command installs the selected EXs data onto the internal SSD, along with any associated files (.KSC, .PCG, .SNG etc). Note that EXs can only be installed onto the internal SSD, and not to USB storage media.

To install an EXs:

1. If you downloaded the EXs data, un-zip the downloaded file.

Un-zipping the archive will result in a folder containing several different files.

Note: Depending on your browser settings, the downloaded file may be unzipped automatically. One of the files in the resulting folder has a name which ends with “tar.gz.” Please do not un-zip this tar.gz file.

2. Copy the un-zipped folder to a USB storage device.
3. Safely disconnect the USB storage device from your computer.
4. Connect the USB storage device to the NAUTILUS.
5. Go to the MEDIA– Utility page.
6. Using the Drive Select menu at the bottom of the page, select the USB storage device.

You may need to wait a few seconds after connecting the device before it is recognized.

7. Open the folder containing the EXs data from step 2.
8. Select the file whose name ends in .exsins.

The “exsins” suffix stands for “EXS INStaller.” For instance, an installer file might be named “EXs10.exsins.”

When a .exsins file is selected, the **Load** button changes to read **Install**. Only one EXs can be installed at a time. If **Multiple Select** is **On**, **Install** will be disabled.

9. Select **Install EXs** from the menu, or press the **Install** button.

The system will check to confirm that the installation files are valid, and that there is sufficient space on the SSD to install the EXs. Next, a dialog box will appear:

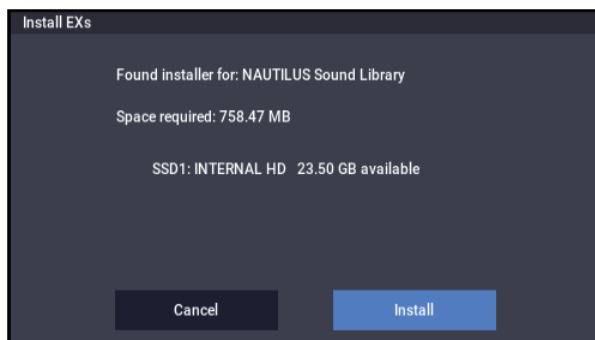

Found installer for: [EXs name]

Space required: [nnn] MB

SSD1: [drive name] [nnn] GB available

10. Press **Install** to continue with the installation, or press **Cancel** to stop without installing.

An “are you sure?” message will appear to confirm the installation.

11. Press **OK** to continue with the installation, or press **Cancel** to stop without installing.

The installation will then begin. This may take a while; a progress bar shows the installation as it proceeds. Next, the newly installed files will be verified.

After the verification has completed successfully, the progress bar will disappear, and the installation is complete. The EXs sample data itself is installed on an invisible, protected part of the drive. To use the EXs, you’ll load its associated files (.KSC, .PCG etc.); for the location of these files, see the documentation of the specific EXs.

Using the newly installed EXs

To use the new EXs:

1. Load the newly installed .PCG and .KSC files.

Make sure to back up any sounds before over-writing them in memory. You may need to free up sample RAM, or use the “Clear” option when loading the .KSC. You can also load specific sounds from the .KSC, make your own sub-sets of its sounds, and automatically load the new samples at startup. For more information, see:

GLOBAL “0–3: KSC Auto-Load” on page 640

GLOBAL “0–4: Sample Manage” on page 643

MEDIA mode menu command “Load .PCG” on page 705

MEDIA mode menu command “Load .KSC” on page 714

Authorization

If an authorization code is required, the EXs will work in demo mode, fading in and out, until the code is purchased and entered into the NAUTILUS. For more information, see “GLOBAL > Options Info” on page 684.

Error messages

When installing, error messages may be displayed to indicate problems, as described below.

“Error: invalid option file” means that the installation data is corrupted. Copy the file to the USB media again, or if that fails, download the data again.

“Error: not enough disk space for the installation” means that the internal SSD is too full. Remove data from the SSD, backing it up to USB media, in order to free up space.

Uninstalling EXs

Optional EXs may be uninstalled to reclaim space on the internal drive(s). For more information, see “Uninstall EXs” on page 694.

Effect Guide

Overview

The NAUTILUS provides 12 insert effects, two master effects, and two total effects, together with a mixer section that controls the routing of these effects.

For each of these effect processors, you can choose from 197 different types of effects, grouped into the following categories:

Effects categories

| | |
|---------------------------|---|
| Dynamics: 000...010 | Dynamics-type effects such as compressor and limiter |
| EQ/Filter: 011...026 | Filter-type effects such as EQ, exciter, and wah |
| OD/Amp/Mic: 027...039 | Overdrive effects and modeling effects such as guitar/bass amps and mics |
| Cho/Fln/Phs: 040...054 | Pitch and phase modulation effects such as chorus and flanger |
| Mod/PShift: 055...076 | Other modulation effects such as tremolo and rotary speaker, and pitch shifters |
| Delay: 077...099 | Delays |
| Reverb/ER: 100...108 | Reverb and early reflections |
| Mono-Mono: 109...140 | Mono & Mono chain effects that internally connect two mono effects in series |
| Mono/Mono: 141...185 | Mono & Mono parallel effects that allow two mono effects to be applied to L and R independently |
| Vintage: 186...197 | Collection of vintage effects from the EP-1 and CX-3 |

Effect presets

You can save parameter settings for each effect from 001:Stereo Compressor through 197:Rotary Speaker Pro CX Custom, to the NAUTILUS's internal memory. This function is called "effect presets".

Although the effect parameters you have configured are saved for each Program, Combination and song, effect presets let you save variations for each effect. The effect settings you like are saved as presets, and you can easily recall them from other Programs or modes.

The following presets can be saved to memory for each effect.

P00: Initial Set: These are the default settings that are recalled when selecting an effect on the Insert FX page. The settings cannot be saved here.

P01...P15: This area includes the preset data.

U00...U15: This area is for saving user settings.

 Some effects do not contain preset data.

-----: This will be shown after selecting the effect. The function does not work simply by being displayed. Selecting the "-----" will not change anything.

For more information, see "Effect preset function" on page 103.

Effects in each mode

PROGRAM mode

With HD-1 Programs, you can use insert effects to process the final sound in the same way that you use the Filter, Driver, Amplifier, and EQ (equalizer) to process the sound from the oscillators (OSC 1 & 2). Then the master effects are used to create overall ambience such as reverb, and use the

total effects to make final adjustments. All of these settings can be made independently for each program. EXi Programs have a different filter and amp structure for each type, but you can also apply insert effects, master effects, and total effects to the oscillators (EXi1&2), just as for an HD-1 program.

PROGRAM mode: HD-1

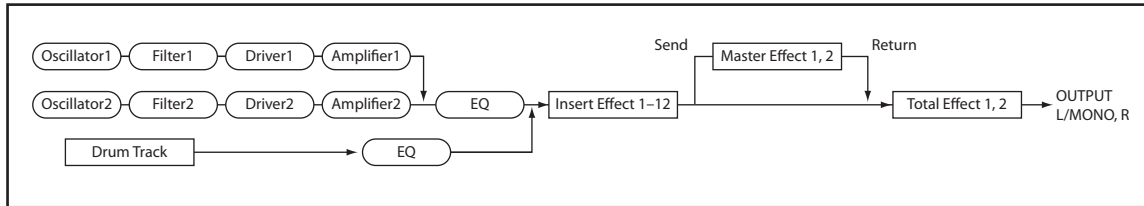

COMBINATION and SEQUENCER modes

In COMBINATION and SEQUENCER modes, you can use the track EQ and insert effects to process the program sound (and audio track sound) of each timbre/track. Then you can use the master effects to create overall ambience, and use the total effects to make final adjustments.

In COMBINATION mode you can make these settings for each combination, and in SEQUENCER mode you can make them for each song.

In SEQUENCER mode, you can switch between effects or modify the effect parameters and record these changes, so that effects will switch automatically or effect parameters will be modified automatically as the song plays back.

COMBINATION and SEQUENCER modes

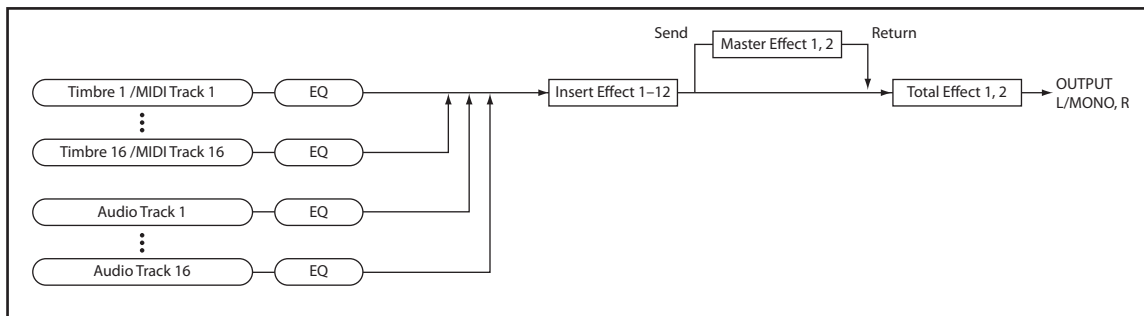

SAMPLING mode

In SAMPLING mode, external audio sources from AUDIO INPUT 1-2, and USB jacks can be processed by insert effects, master effects, and total effects, and then sampled.

Use the Recording– Audio Input page to make audio input settings for SAMPLING mode. These settings apply only to SAMPLING mode.

Samples that you've assigned as a multisample can also be processed by the insert effects, master effects, and total effects, and then resampled.

SAMPLING mode

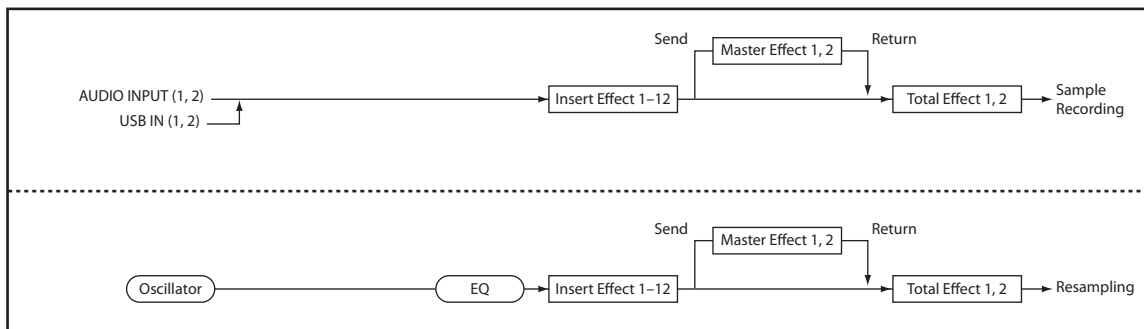

Audio Input

You can also use the external audio inputs in PROGRAM, COMBINATION, and SEQUENCER modes.

You can apply the insert effects, master effects, and total effects to external audio sources and sample them, or use the NAUTILUS as a 4-in (stereo analog, and USB) 6-out effect processor. You can also use an external mic input to control a vocoder effect (026: Vocoder) applied to internal sounds.

In SEQUENCER mode you can also use the effects when recording external audio sources to audio tracks.

⚠ When effects are applied to the audio inputs, certain effect types or parameter settings may cause oscillation to occur. If this occurs, adjust the input level, output level, or effect parameters. Please be aware of this particularly when using an effect that has a high gain.

Use the Sampling page of each mode to make audio input settings. Alternatively, you can check **Use Global Setting** and make these settings in the GLOBAL > Basic Setup–Audio page. Normally you will leave Use Global Setting checked. Uncheck this if you want programs and combinations to use their own settings—for example, when writing a program to use as a vocoder effect.

Audio Input (PROGRAM mode)

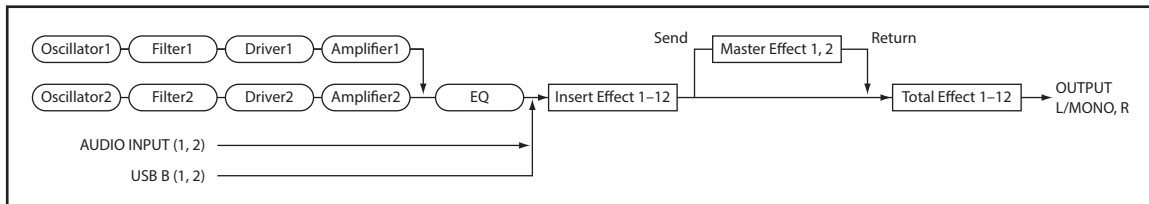

Dynamic modulation (Dmod) and Tempo Synchronization

Dynamic modulation (Dmod)

Dynamic modulation lets you control certain effects parameters in real-time, using either the built-in controllers or MIDI. These effect parameters are marked with the logo .

For more information, see “Dynamic Modulation Sources (Dmod)” on page 912.

Tempo Synchronization

You can synchronize some effects parameters, such as LFO speeds and delay times, to the system tempo. This lets you sync the effects to Program LFOs, step sequencers, Wave Sequences, X-Y Envelope, ARP, the internal sequencer, and external MIDI clocks.

These effects parameters are marked with the logo .

Synchronizing LFOs

Most effects with LFOs, such as 016: Stereo Wah/Auto Wah, can be synchronized to tempo. This applies to the individual effects LFOs, and also the Common FX LFO.

To set up LFOs to synchronize to tempo:

1. Set **MIDI/Tempo Sync** to **On**.
2. Set the **BPM** as desired.

To synchronize to the system clock, set **BPM** to **MIDI**.

To set the LFO to a specific tempo, separate from the system clock, set **BPM** to the desired tempo (between 40 and 240 BPM).

3. Use the **Base Note** and **Times (x)** parameters to set the **rhythmic value of the LFO**.

For instance, if you set **Base Note** to 1/8 and **Times (x)** to 2, each cycle of the LFO will last for a quarter-note (two eighth-notes).

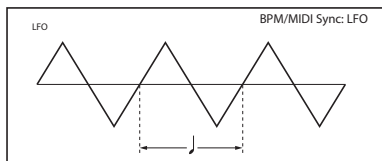

Synchronizing Delay Times

Delays with “BPM” in their title will sync to tempo.

For instance, you might set up effect 093: Stereo BPM Delay as follows:

1. Set **L Delay Base Note** to 1/8, and **Times (x)** to 1
2. Set **R Delay Base Note** to 1/16, and **Times (x)** to 3

This means that the left channel will be delayed by an eighth-note, and the right channel will be delayed by a dotted eighth-note (three sixteenth-notes).

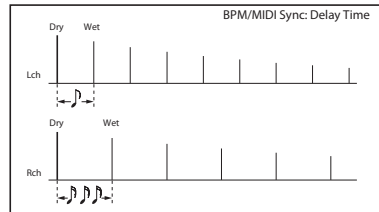

3. Set the BPM as desired.

To synchronize to the system clock, set **BPM** to **MIDI**.

To set the delays to a specific tempo, separate from the system clock, set **BPM** to the desired tempo (between 40 and 240 BPM).

If the combination of the tempo, **Base Note**, and **Times (x)** settings in conjunction would exceed the maximum delay time, a warning such as “Time Over? >OVER!” will appear in the display. If this happens, just reduce the delay time. Note that the maximum delay time depends on which delay effect you’re using. For instance, the maximum delay time for 093: Stereo BPM Delay is 1,360msec, while the maximum delay time for 094: Stereo BPM Long Delay is 2,730msec.

Common FX LFOs

Normally, LFO-based effects—such as choruses, flangers, phasers, filters, and auto-panners—each have their own independent LFO. The NAUTILUS effects support this standard mechanism, but add a new one: Common FX LFOs.

The two Common FX LFOs allow you to synchronize multiple LFO-based effects together. They're available in most LFO-based effects, in addition to the individual LFOs, providing:

- Master sources of frequency and phase for all LFO-based effects
- LFO speed set by either frequency or tempo
- Reset from Dmod sources, for either realtime performance or synchronizing to a down-beat in a sequence

When using the Common FX LFOs, you can still control the LFO phase individually for each effect, and often change the waveform individually as well.

You can edit the Common FX LFO parameters on the P8—Common FX LFO pages of PROGRAM, COMBINATION, SEQUENCER, and SAMPLING modes.

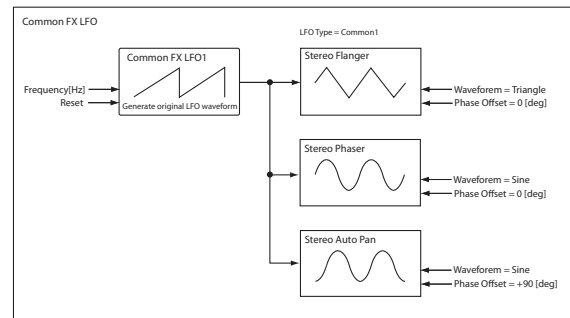

FX Control Buses

The FX Control Buses lets you create effects “sidechains.” Sidechains let you control an effect with one audio signal (the sidechain), while the effect processes a completely different audio signal. This is convenient for use with vocoders, compressors and limiters, gates, etc.

NAUTILUS includes two stereo FX Control Buses, which can be used with the following effects:

Vocoder

- 026: Vocoder

Compressor, limiter, and gate effects

- 002: Stereo Compressor
- 003: Stereo Expander
- 005: Stereo Limiter
- 009: Stereo Gate
- 010: Stereo Noise Reduction

Gated Reverb (PROGRAM mode)

The classic gated reverb sound is created using a sidechain:

- Dry audio goes through a reverb effect
- The output of the reverb goes to a gate effect
- The opening and closing of the gate is controlled by the original dry audio, through a sidechain

To create this on the NAUTILUS, in PROGRAM mode:

1. On the IFX Routing page, set Bus Select to IFX1.
2. Set FX Control Bus to FX Control 1.
3. On the IFX Insert Effects page, set IFX1 to 101: Reverb Hall.
4. Set IFX2 to 009: Stereo Gate.
5. Enable Chain for IFX1, and set Chain To to IFX2.
6. In the Stereo Gate effect, set the Envelope Source to FX Control 1.

Now, the gate will affect the output of the reverb, but the gate will be controlled by the pre-reverb dry signal.

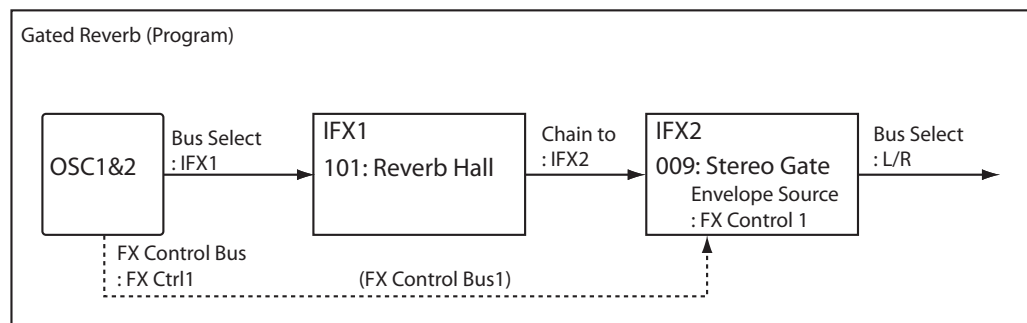

Compressor (COMBINATION mode)

Compressors, limiters, and gates use the level of the audio input to control the level of the audio output. For these effects, the envelope detection source can be either the audio input itself (the usual method) or FX Control Bus 1 or 2.

The diagram below shows a split Combination, with a pad on the bottom of the keyboard and a distorted guitar on the top. The output of the OD/High-Gain Wah effect controls the action of the pad's compressor, so that when the guitar is played, the level of the pad decreases automatically. To do this:

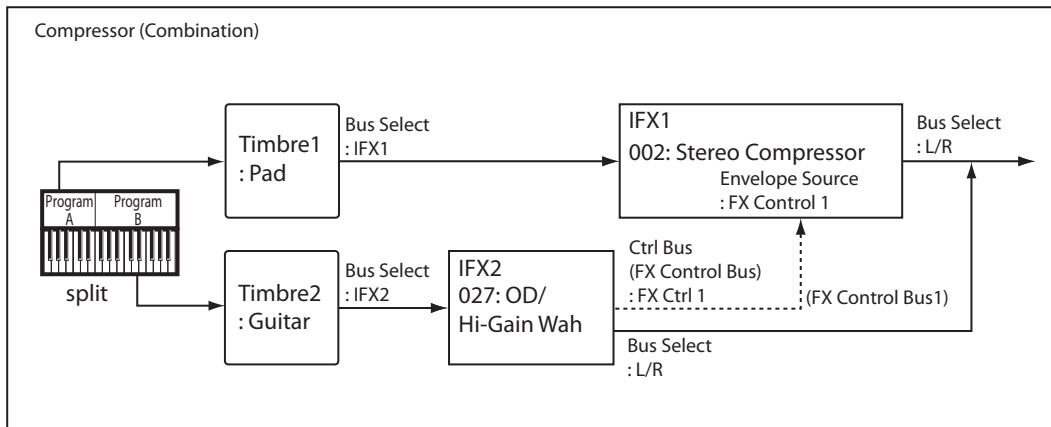

1. Set up the Timbres and effects as shown in the diagram below.

2. Set IFX2's Ctrl Bus to FX Ctrl1.

This sends the output of IFX2 to FX Control Bus 1.

3. In IFX1: Stereo Compressor, set the Envelope Source to FX Ctrl1.

Now, the compressor will still process the input from the pad, but the amount of compression will be controlled by the guitar (through IFX2).

Vocoder (PROGRAM mode)

Vocoder effects produce their distinctive sound by using an audio signal (the modulator) to modulate a different audio signal (the carrier). In the diagram, the combined output of OSC1 and 2 is the carrier, and the audio input from a mic is used as the modulator to produce a "speaking instrument" type of effect. To do this:

1. In the Program, set Bus Select to IFX1.

This sends the output of the Program to the Vocoder.

2. For the Audio Input, set the FX Control Bus (0-8c) to FX Control 1.

This sends the audio input to FX Control Bus 1.

3. In IFX1: Vocoder, set the Modulator Source to FX Control 1.

Now, through FX Control Bus 1, the audio input is the modulator for the vocoder.

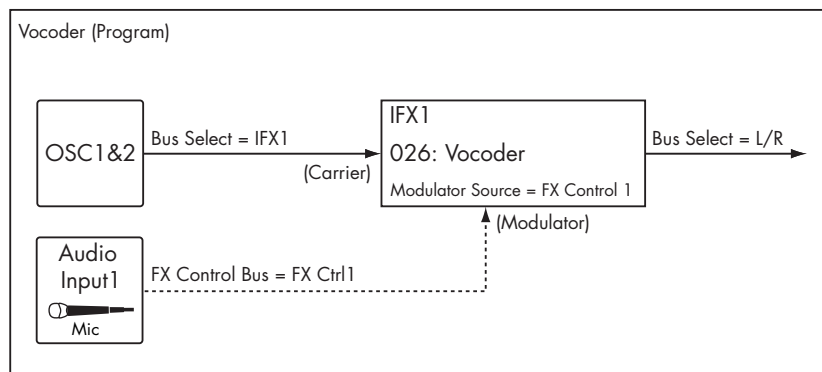

Rhythmic Vocoder (COMBINATION mode)

Vocoder effects produce their distinctive sound by using an audio signal (the modulator) to modulate a different audio signal (the carrier). Although the most common application of a vocoder is to use audio from a mic as the modulator, you can also use a drum pattern or similar signal as the modulator, producing a rhythmic effect.

In the example shown in the diagram, a drum pattern generated by ARP is sent to an FX Control bus and used as the modulator for the vocoder. To do this:

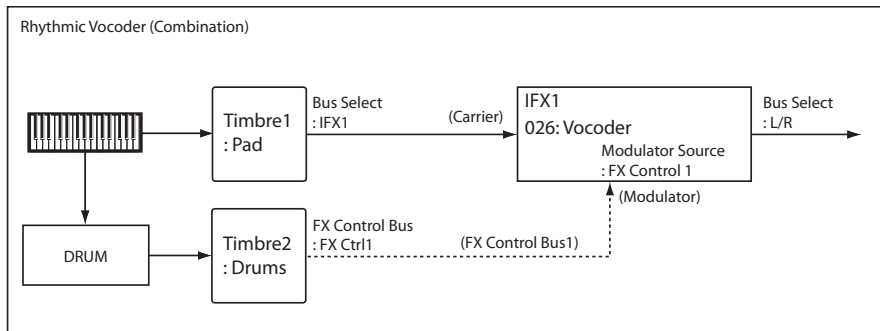

1. For **Timbre 1 (the carrier)**, set **Bus Select** to **IFX1**. This sends the signal to the Vocoder, as the carrier.
2. For **Timbre 2 (the drum program we're using as the modulator)**, set **FX Control Bus** to **FX Ctrl1**.

This sends the signal from Timbre 2 to FX Control Bus 1.

3. In **IFX1: Vocoder**, set the **Modulator Source** to **FX Control 1**.

Now, through FX Control Bus 1, Timbre 2 is the modulator for the vocoder.

Parallel Effects routing

You can create parallel effects paths using the FX Control Buses. You'll need to use one IFX slot to do so, however.

1. **Route the signal (program, IFX output, etc.) to an output or IFX bus as normal.**
2. **In addition to the normal bus, assign it to one of the FX Control Buses.**
3. **Place an effect which uses the FX Control Buses - the Stereo Compressor, for instance - on any IFX.**

4. **In the Stereo Compressor, set the Envelope Source to the FX Control Bus from step 2.**
5. **Also in the Stereo Compressor, enable the check-box labeled Side Chain Monitor.**

Enabling **Side Chain Monitor** means that, instead of hearing the output of the compressor, you'll hear the FX Control Bus input. You can save the effect in this state.

At this point, the compressor is simply serving as a way to access the FX Control Bus, and you can use it to start the parallel branch of the effects chain.

Effect I/O

To achieve the best tonal quality, signals sent to the effects should be at the maximum level below clipping. Also, use the **Wet/Dry** parameter for the Insert Effects, Total Effects and the **Output Level** or **Return 1/ 2** parameters for the Master Effects to adjust the effect output level.

- ⚠ If the input level is too low, the SN ratio may decrease. On the other hand, if the input level is too high, clipping may occur. The Global **Internal Headroom** setting will also change the maximum input level of the effect.

The following tables show the parameters related to volume level:

PROGRAM mode (HD-1)

| |
|---|
| OSC1/2 MS1...8 Level (OSC/Pitch page) |
| Filter1/2 Input Trim (Filter page) |
| Filter1/2 Output Level (Filter page) |
| Driver1/2 Drive (Amp/EQ page) |
| Amp1/2 Amp Level (Amp/EQ page) |
| EQ Input Trim (Amp/EQ page) |
| Send1/2 (IFX page) |
| Effect Trim parameter *1 (IFX page, MFX/TFX page) |

| |
|---|
| Effect Wet/Dry parameter (IFX page, MFX/TFX page) |
| Return1, 2 (MFX/TFX page) |
| Master Volume (MFX/TFX page) |

PROGRAM mode (EXi: Common)

| |
|---|
| EQ Input Trim (EQ page) |
| Send1/2 (IFX page) |
| Effect Trim parameter *1 (IFX page, MFX/TFX page) |
| Effect Wet/Dry parameter (IFX page, MFX/TFX page) |
| Return1, 2 (MFX/TFX page) |
| Master Volume (MFX/TFX page) |

PROGRAM mode (AL-1)

| |
|--|
| OSC Mixer Level (OSC1, OSC2, Sub OSC, Ring Mod., Noise) (AL-1: OSC/Pitch page) |
| Filter1/2 Input Trim (Filter page) |
| Filter1/2 Output Level (Filter page) |
| Driver1/2 Drive (AL-1: Amp page) |
| Amp1/2 Amp Level (AL-1: Amp page) |

PROGRAM mode (CX-3)

| |
|---|
| Expression Minimum, Level (CX-3: Basic page) |
| Drawbar (CX-3: Split/Drawbar page) |
| Output Level (CX-3: Amp/VC/Rotary Speaker page) |

PROGRAM mode (STR-1)

| |
|---|
| Mixer Level (STR-1: String-Mixer page) |
| Filter Input Trim, Level (STR-1: Filter page) |
| Amp Level (STR-1: Amp page) |

PROGRAM mode (MS-20EX)

| |
|--|
| VCO Mixer, Level (MS-20EX: Oscillators & Filters page) |
| Mixer1, 2 (MS-20EX: MG, EG, and Modulation page) |
| Volume (MS-20EX: Patch Panel page) |

PROGRAM mode (PolysixEX)

| |
|--------------------------------------|
| Output Volume (PolysixEX: Main page) |
|--------------------------------------|

PROGRAM mode (MOD-7)

| |
|--|
| Level (MOD-7: Oscillator page) |
| Output Level (MOD-7: Oscillator page) |
| Filter Output Level (MOD-7: Filter page) |
| Mixer Level (MOD-7: Amp & Mixer page) |
| Amp Level (MOD-7: Amp & Mixer page) |

PROGRAM mode (SGX-2)

| |
|-------------------------------|
| Volume (SGX-2: Main page) |
| Components (SGX-2: Main page) |

PROGRAM mode (EP-1)

| |
|---|
| Harmonic/Attack Noise/Release Noise Level (EP-1: Basic/Oscillator page) |
| Output Level (EP-1: Basic/Oscillator page) |
| Volume (EP-1: Panel/IFX/Amp page) |
| Cabinet On/Off, Drive (EP-1: Panel/IFX/Amp page) |

COMBINATION and SEQUENCER modes

| |
|---|
| Volume (Home page) |
| Timbre EQ Input Trim (EQ/X-Y/Controllers page) |
| Send1/2 (IFX page) |
| Effect Trim parameter *1 (IFX page, MFX/TFX page) |
| Effect Wet/Dry parameter (IFX page, MFX/TFX page) |
| Return1, 2 (MFX/TFX page) |

SAMPLING mode

| |
|---|
| Analog Input Level (Recording page) |
| Effect Trim parameter *1 (IFX page, MFX/TFX page) |
| Send1/2 (Recording page, IFX page) |
| Effect Wet/Dry parameter (IFX page, MFX/TFX page) |
| Return1, 2 (MFX/TFX page) |

*Audio Input *2*

| |
|---------|
| Level |
| Send1/2 |

*1 Some effects may not have these parameters.

*2 These settings are made separately for Programs, Combinations, and Songs. If “Use Global Setting” is checked, these settings are made in GLOBAL > Basic Setup – Audio page.

Insert Effects (IFX1...IFX12)

In/Out

Insert Effects (IFX 1–12) have a stereo input and a stereo output. If you set the **Wet/Dry** parameter (IFX– IFX1–12 page) to Dry (no effect), the input signal will be passed through, in stereo, without being processed by the effect. If you select Wet (effect applied), the processed signal will be output in one of the following ways:

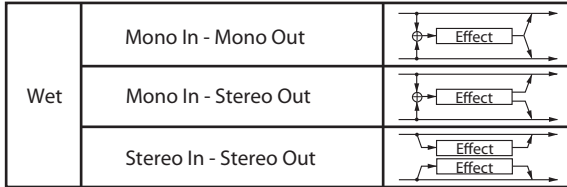

IFX1: 148: P4EQ // Phaser



Mono–Mono Parallel Effects

141: P4EQ // P4EQ - 185: Mt.BPM Dly // Mt.BPM Dly

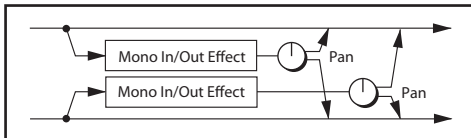

These effects are typically stereo-in/stereo-out, but they have a special structure. The L channel and R channel of the stereo input each have their own independent mono effect. Each mono output can then be panned to the desired position in the stereo field.

- Track1: Piano, **Pan**=L001, **Bus Select**=IFX1
- Track2: E.Piano, **Pan**=R127, **Bus Select**=IFX1

So that you don't mix the sound of the two tracks that are being input, set the SEQUENCER > Home– Mixer page **Pan** parameter to L001 and R127 respectively.

Example: IFX1: 148: P4EQ // Phaser

Track 1: Piano is sent to the L channel P4EQ, and Track 2: E.Piano is sent to the R channel Phaser. Use the IFX– Insert FX page **Pan** parameter to set the output position of each sound. In this example, both are set to C064. See the diagram below.

If you select **000: No Effect**, stereo input signals are output in stereo without being processed.

Pressing the ON/OFF button of IFX1–IFX12 in the IFX– Insert FX pages in each mode will toggle between ON and OFF. When OFF is selected, the effect will be bypassed, and the stereo input signal will be output in stereo without being processed.

MIDI The NAUTILUS can also turn IFX1–IFX12 off separately from the setting of the ON/OFF button by receiving MIDI control change message CC#92. Value 0 will turn them off, and value 1–127 will turn them on.

You can also use “Effect Global SW” to turn IFX1–12 on and off. This MIDI control is performed on the global **MIDI channel**.

Routing

You can use up to twelve channels (IFX 1...12) for the Insert Effects in any mode.

PROGRAM mode

Use **Bus Select** (PROGRAM 8-1c) to set the destination bus of the oscillator output.

L/R: Send the output to the L/R bus. Instead, it is sent to AUDIO OUTPUT (MAIN) L/MONO and R after the TFX1 and 2.

IFX1...12: The signal is sent to Insert Effects IFX 1-12.

1...4, 1/2...3/4: The signal is sent to the selected Individual Output. For more information, please see "Individual Outputs" on page 759.

Off: The output will not be sent to the L/R bus, IFX1-12 buses, or Individual 1-4 buses. Choose the Off setting if you want to connect the oscillator output to a master effect in series. Use **Send1 (to MFX1)** and **Send2 (to MFX2)** to adjust the send level.

Use **Send1 (to MFX1)** and **Send2 (to MFX2)** (PROGRAM 8-1f) to specify the send level for the Master Effects. This setting is effective if **Bus Select** (PROGRAM 8-1c) is set to L/R or Off.

If **Bus Select** is set to IFX1-12, use **Send1** and **Send2** (PROGRAM 8-5a) to specify the send level of the post-IFX signal.

MIDI Send1 responds to CC#93, and Send2 responds to CC#91. At this time, the actual send level uses the value of the Send 1 and 2 settings for Oscillators 1 and 2, multiplied by the Send 1 and 2 values received via MIDI.

In the example shown in the diagram (Fig. 2-1a), Oscillators 1 and 2 outputs being sent to IFX1.

If you are connecting the Insert Effects in series, **check the Chain box** (PROGRAM 8-5a). Use **Chain to** (PROGRAM 8-5a) to specify the destination to which the signal will be chained.

If you check the IFX1 checkbox, the output of IFX1 will be sent to the input of the IFX you specify in "Chain to."

Effects can be chained only in ascending order of their number; for example IFX1 can be chained to IFX2 through IFX12, and IFX2 can be chained to IFX3 through IFX12.

You can create a chain of up to twelve insert effects in series, IFX1 through IFX12.

When the Insert Effects are connected in series, the values of the **Pan (CC#8)**, **Bus Sel.**, **REC Bus**, **Send1**, and **Send2** parameters for the post-IFX signal will be used.

In the example shown in the diagram (Fig. 2-1b), the **Chain** check box is checked, and each **Chain to** parameter is set to the subsequent effect, creating a series connection of IFX1 → IFX2 → IFX3 → IFX4 → IFX5 → IFX6 → IFX7 → IFX8 → IFX9 → IFX10 → IFX11 → IFX12. The post-IFX12 settings for **Pan (CC#8)**, **Bus Select**, **REC Bus**, **Send1**, and **Send2** will be used.

Settings for drum programs

If you have selected "Drums" for **Oscillator Mode** (PROGRAM 1-1b) of a Program, the "Use DKit Setting" box (PROGRAM 8-1b) becomes available. For more information, please see diagram Fig. 2-1c.

If you **check this box, Bus Select (IFX/Indiv.Out Assign), FX Control Bus, Send1 (to MFX1), and Send2 (to MFX2)** (GLOBAL 4-3b) for each key of the selected DrumKit becomes effective. For example, you can send a snare sound to IFX1 to apply the Gate effect, a kick sound to IFX2 to apply EQ, and other sounds to AUDIO OUTPUT (MAIN) L/MONO and R without applying any Insert Effects.

Tip: In most of the preloaded drum kits, the following types of drum instrument have the same **Bus Select** settings.

- Snares → IFX1
- Kicks → IFX2
- Toms → IFX3
- Cymbals → IFX4
- Percussion etc. → IFX5

Fig. 2-1a



If you de-select the box, all drum instrument outputs are sent to the bus specified by **Bus Select** (PROGRAM 8-1c). You may apply any Insert Effects to all drum instruments, regardless of the DrumKit settings.

Fig. 2-1b



Fig. 2-1c



COMBINATION and SEQUENCER modes

Use **Bus Select** (IFX– Routing1 and 2 page in each mode) for timbres (Combination) and tracks (Sequencer) to select an Insert Effect to apply to the corresponding timbres and tracks. You can route multiple timbres and tracks to a single Insert Effect.

Tip: You can use each timbre/track’s **Bus Select**, post-IFX **Chain to** and **Chain** parameters (IFX– Insert FX page of each mode) to create a variety of routings.

Example: Inserting one IFX into two or more timbres

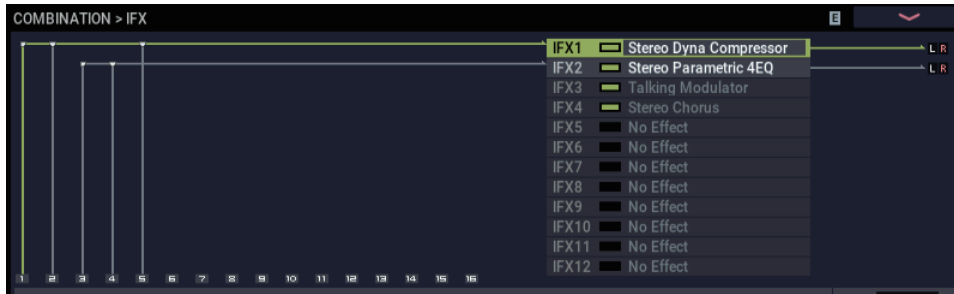

Example: Inserting a separate IFX into each timbre, and inserting another IFX later

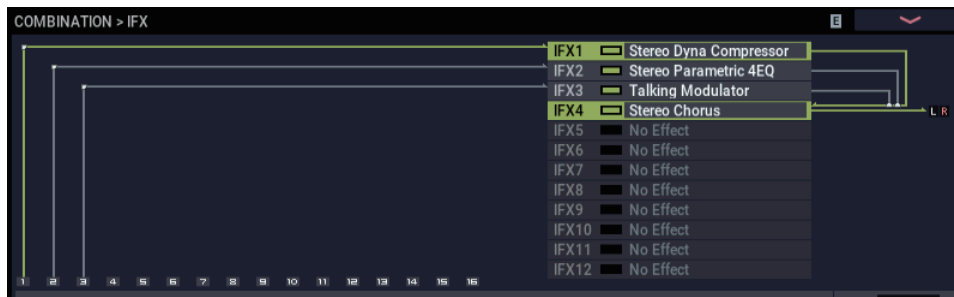

Example: Sharing part of a timbre’s IFX chain with another timbre



As with PROGRAM mode, select L/R, IFX1–12, 1–4, 1/2–3/4, or Off for each timbre and track.

Send1 (to MFX1) and **Send2 (to MFX2)** become available if **Bus Select** has been set to L/R or Off. If you’ve set **Bus Select** to IFX1–12, use **Send1** and **Send2** (IFX– Insert FX page) following the insert effect to adjust the send levels.

MIDI Send1 responds to CC#93, and Send2 responds to CC#91. At this time, the actual send level uses the value of the Send 1 and 2 settings for Oscillators 1 and 2 of the Programs (selected for the timbres and tracks), multiplied by the Send 1 and 2 values received via MIDI.

The following diagram (Fig. 2-2a) shows an example of COMBINATION mode. The Timbre 1 output is sent to IFX1 and the Timbre 2 output is sent to IFX2 according to the Bus

Select setting. Other timbres are sent to L/R. The output signal passes through the TFX1 and 2, then goes to AUDIO OUTPUT (MAIN) L/MONO and R.

Fig. 2-2a



In the diagram (Fig. 2-2b), IFX1's Chain check box is checked and Chain to set to IFX2, sending the output of IFX1 to IFX2. Timbre 1 is being processed by IFX1: 001: Stereo Dyna Compressor and IFX2: 048: Stereo Flanger

effects. Timbre 2 is being processed by the IFX2: 048: Stereo Flanger effect. The Routing Map area of the diagram (Fig. 2-1a) shows these settings. (With these settings, IFX3-12 are not being used.)

Fig. 2-2b



Drum Programs in COMBINATION and SEQUENCER modes

If a drum program (**Oscillator Mode** = Drums) is selected for a timbre (Combination) or track (Sequencer), the DKit check box is available (Fig. 2–2c).

Checking this check box will enable the **Bus Select** settings etc. of each key in the drum kit, letting you specify the bus to which each drum instrument will be sent. For example you can send snare sounds to IFX1, kick sounds to IFX2, and other drum sounds to L/MONO and R.

If this check box is **unchecked**, all drum instruments will be output according to the **Bus Select** setting of each timbre/track (IFX– Routing page of each mode). This lets you apply an insert effect to all of the drum instruments in that drum kit.

Drum Kit IFX Patch

If “Bus Select DKit” is checked, you can select the **Drum Kit IFX Patch** page menu command by selecting a timbre parameter or by pressing Timbre Number (the blue area in the display for each timbre).

This option allows you to change the routing of the Insert Effects temporarily by changing **Bus Select** for each key.

For example, assume that the DrumKit key assignment is set so that a snare sound is routed to IFX1 and a kick sound is routed to IFX2 etc., IFX1–5. In this case, if you wish to assign IFX 1 and 2 to the Programs used by other timbres and tracks, you can view the routing so that these DrumKit sounds are routed to IFX3 and IFX7 respectively.

Patching is possible only if the **Bus Select (IFX/Indiv.Out Assign)** (GLOBAL 4–3b) setting of each key in the drum kit is assigned to an insert effect. The state of these settings is also shown in the Routing Map. Make the desired settings for “DrumKit IFX Patch,” and press the OK button to execute.

If you want to revert to the original settings of the drum kit, execute **Drum Kit IFX Patch** with the settings IFX1 → IFX1, IFX2 → IFX2, IFX3 → IFX3, IFX4 → IFX4, IFX5 → IFX5, IFX6 → IFX6, IFX7 → IFX7, IFX8 → IFX8,

IFX9 → IFX9, IFX10 → IFX10, IFX11 → IFX11, and IFX12 → IFX12. You can also revert to the original settings by pressing the RESET button.

In diagram (Fig. 2–2c) below, Drum Program is assigned to Timbre 1, and normal Programs are assigned to Timbres 2 and 3. **Bus Select** is set to DKit for Timbre 1, IFX1 for Timbre 2, and IFX2 for Timbre 3. With Timbre 1, the **Bus Select (IFX/Indiv.Out Assign)** (GLOBAL 4–3b) for DrumKit setting becomes effective.

Fig. 2–2d: DrumKit IFX Patch dialog



Use the **Drum Kit IFX Patch** page menu command if you want the drum program to use effects other than timbres 2 and 3. Choose **Drum Kit IFX Patch** from the page menu, and temporarily send the drum kit IFX1 to IFX3, IFX2 to IFX4, IFX3 to IFX5, IFX4 to IFX6, and IFX5 to IFX7 (Fig. 2–2d). Executing with these settings will temporarily change the effects to which the drum kit is being sent (Fig. 2–2e).

Fig. 2–2c



Fig. 2-2e

COMBINATION > IFX

IFX1 Stereo Dyna Compressor L R
 IFX2 Stereo Flanger L R
 IFX3 Stereo Limiter L R
 IFX4 Stereo Dyna Compressor L R
 IFX5 Stereo Limiter L R
 IFX6 No Effect L R
 IFX7 No Effect L R
 IFX8 No Effect
 IFX9 No Effect
 IFX10 No Effect
 IFX11 No Effect
 IFX12 No Effect

C000: Init Combination 120.00

T 01 : HD-1 0018: Studio Standard Kit Ch : Gch

| 1 | 2 | 3 | 4 | 5 | 6 | 7 | 8 | 9 | 10 | 11 | 12 | 13 | 14 | 15 | 16 |
|----------|----------|-------|-------|-------|-------|-------|-------|-----------|-------|-------|----------|-------|-------|-------|---------------|
| Drums | Piano | Piano | Piano | Piano | Piano | Piano | Piano | Piano | Piano | Piano | Piano | Piano | Piano | Piano | Piano |
| DKit | DKit | DKit | DKit | DKit | DKit | DKit | DKit | DKit | DKit | DKit | DKit | DKit | DKit | DKit | DKit |
| L/R | IFX 1 | IFX 2 | L/R | L/R | L/R | L/R | L/R | L/R | L/R | L/R | L/R | L/R | L/R | L/R | L/R |
| 127 | 127 | 127 | 127 | 127 | 127 | 127 | 127 | 127 | 127 | 127 | 127 | 127 | 127 | 127 | 127 |
| 127 | 127 | 127 | 127 | 127 | 127 | 127 | 127 | 127 | 127 | 127 | 127 | 127 | 127 | 127 | 127 |
| Routing1 | Routing2 | | | | | | | Insert FX | | | IFX 1-12 | | | | Common FX LFO |

SAMPLING mode

The analog, and USB audio inputs can be processed by the insert effects, master effects, or total effects then sampled. You can also apply insert effects to the samples assigned to a multisample, and resample the result.

The **Bus Select** settings in the Recording– Audio Input page specify the buses to which the external inputs will be sent. You can choose from L/R, IFX1–12, 1–4, 1/2–3/4, or Off. If you want to apply an insert effect while sampling, choose IFX1–12.

In the example shown in the diagram (Fig. 2–3a), the signal from AUDIO INPUT 1 and 2 is being sent to IFX1. Use the IFX page to select an insert effect, and edit its parameters.

The following diagram (Fig. 2–3b) shows an example of bus settings in which the samples assigned to a multisample are resampled with IFX1 applied. Set **Bus Select** (SAMPLING 8–1b) to IFX1.

⚠ When sampling ends, L/R will automatically be selected as the **Bus Select** setting. Please be aware of this if you continue sampling.

For more details on any of these sampling methods, please see “Preparations for sampling” on page 126 of the OG.

Fig. 2–3a



Fig. 2–3b



Analog, and USB inputs

In PROGRAM, COMBINATION, and SEQUENCER modes, external audio sources from the analog, and USB inputs can be processed by insert effects, master effects, and total effects just as they can in SAMPLING mode.

You can sample while applying the NAUTILUS's effects to the external audio sources from these jacks, or use the NAUTILUS as a 4-in (analog, and USB) 6-out effect processor. You can also use an external mic input to control a vocoder effect (026: Vocoder) applied to internal sounds.

In SEQUENCER mode you can also use the effects when recording external audio sources to audio tracks.

In each mode, use "Audio Input" (Sampling page) to make settings for the audio inputs. Alternatively, you can check **Use Global Settings** and use the GLOBAL mode "Audio" settings.

Set **Bus Select** to specify the bus to which the external audio input will be sent. You can select L/R, IFX1-12, 1-4, 1/2-3/4, or Off. If you want to apply an insert effect, select IFX1-12.

Send1 (to MFX1) and **Send2 (to MFX2)** become effective only when **Bus Select** is set to L/R or Off. If IFX1-12 is selected, use IFX-Insert Effect page **Send1** and **Send2** for the post-IFX signal.

The diagram (Fig. 2-4a) shows an example in which the input from INPUT 1 and 2 is panned to left and right, and sent to insert effect 1.

 In MEDIA mode, effects will use the settings of the mode in which you previously were.

Fig. 2-4a



Mixer

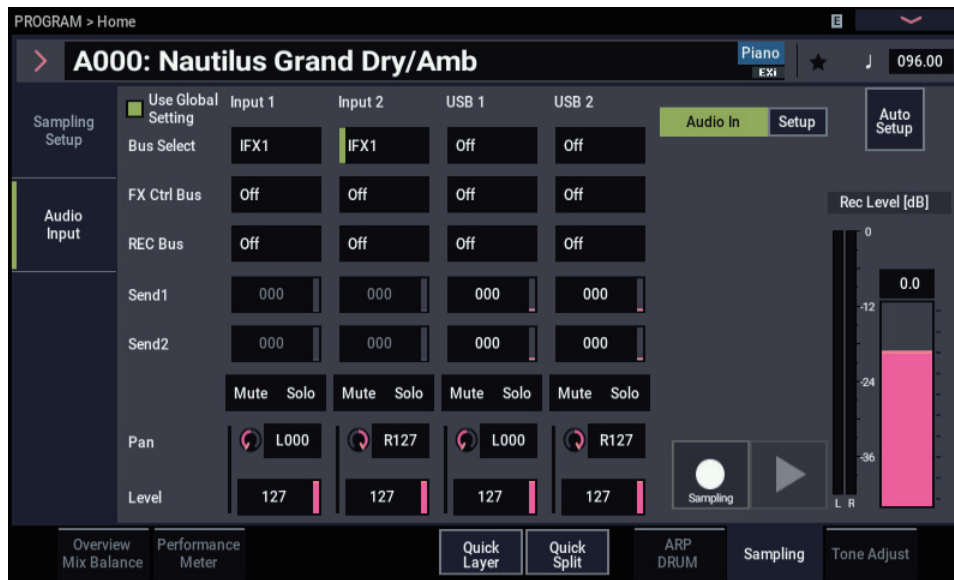

In PROGRAM, COMBINATION, and SEQUENCER modes, the IFX– Insert FX page lets you set “Pan (CC#8)” (post-IFX panning), “Bus Sel. (Bus Select),” “Ctrl Bus” (FX control bus), **REC Bus**, and **Send1** and **Send2** levels to the master effects.

If you have checked the **Chain** to connect the Insert Effects in series, these parameters “Pan (CC#8)” –**Send2** for the post-IFX (last Insert Effect in the chain) signal become effective.

Pan (CC#8)

This parameter enables you to set the pan of the post-IFX signal.

If you are using the stereo-in/stereo-out Insert Effects, set this parameter to “C064” to enable the **Pan** settings for the oscillators (PROGRAM 4–1c, 4–5), timbres (COMBINATION 0–1b), tracks, and audio inputs.

If you are using mono-in/stereo–out or mono-in/mono–out Insert Effects, the **Pan** settings for the oscillators, timbres, tracks and audio inputs are ignored, and they are set to Center. Use the “Pan (CC#8)” parameter (IFX– Insert FX page) to set the pan. “L000” is hard left, and “R127” is hard right.

For more about effect types such as stereo-in/stereo-out, see “In/Out” on page 739.

MIDI You can control these parameters via CC#8.

Bus Sel. (Bus Select)

This parameter enables you to specify the destination bus for the post-IFX signals.

“L/R” is a common setting to send signals to the Total Effects (TFX1, TFX2) before they are routed to the OUTPUT (MAIN) L/MONO and R outputs.

Select 1...4 or 1/2...3/4 to route the signals to one of the Individual Outputs. If this is set to 1–4, the output will be monaural. If set to 1/2–3/4, the post-IFX pan settings will be valid, and the output will be stereo. If set to **Off**, the signal will not be sent to the L/R bus or buses 1–4. Choose this setting if you want to use the **Send1** or **Send2** levels to route the signal through a master effect in series (i.e., not as a send effect).

Ctrl Bus (FX Control Bus)

This specifies the FX Control bus that follows the insert effect. The FX Control buses (FX Control 1, 2) are stereo two-channel buses.

The NAUTILUS provides two (stereo two-channel) effect control buses, giving you a wide range of ways to control effects.

Insert Effect = Stereo In – Stereo Out

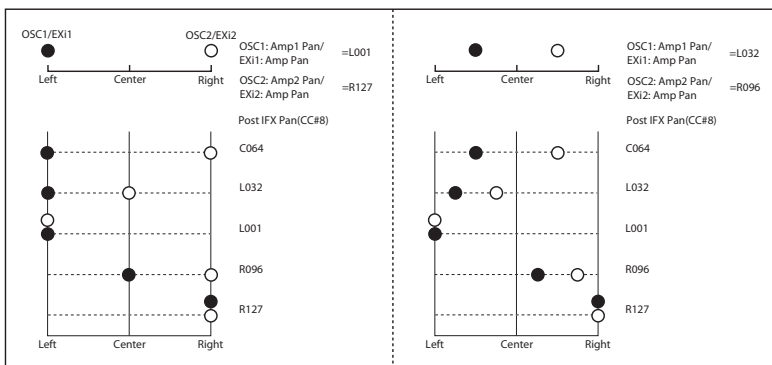

Insert Effect = Mono In - Stereo Out
Mono In - Mono Out

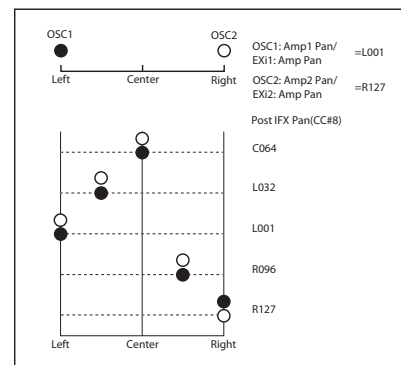

FX Control buses can be used with vocoder, compressor, and gate-type effects.

For details on the effects that be used with FX Control buses, see “FX Control Buses” on page 735.

As an example, here’s how you can use the FX Control bus following an insert effect.

Example: Gated Reverb

When using a gate effect with reverberant sound, using the reverberant sound to control the gate may not produce the desired results because the reverb extends the duration of the sound. Normally, you will use the un-reverberated sound to control the gate, as shown in the diagram below.

In this example, we send the sound from the OSC etc. to IFX1 and process it through an equalizer. IFX1 is sent via **Chain** to IFX2 and also sent via “Ctrl Bus” (FX Control Bus) to FX Control 1. The Envelope **Source** of IFX3: Stereo Gate is set to FX Control 1. This allows the gat to be triggered by a signal other than its input (the reverberant sound).

REC Bus

NAUTILUS provides two stereo recording (REC) buses: REC 1/2 and REC 3/4.

Using the REC busses, you can isolate one or more sounds for recording or sampling—even if the sounds are also being mixed into the main outputs. For example, you can play a

guitar through NAUTILUS IFX while listening to a ARP drum phrase, and record the processed guitar without recording the drums.

Individual Programs, Combi Timbres, Sequencer Tracks (both MIDI and Audio), audio inputs, and Insert Effects can all be routed to the REC busses, in addition to their main output/IFX bus settings.

If you don’t need to use the REC bus for a particular sound, turn it **Off**.

Setting the REC bus to 1, 2, 3, or 4 lets you record up to four mono signals simultaneously. Setting it to 1/2 or 3/4 lets you record stereo signals, including the effects of the “Pan (CC#08)” setting.

Send1, Send2

These parameters enable you to set the send level of the signals routed to Master Effects MFX1 and MFX2. The signal is sent in stereo to master effects MFX1 and MFX2. This is valid when **Bus Select** is L/R or Off.

If you are not using any Insert Effects, use **Send1** and **Send2** of the IFX– Routing page in PROGRAM, COMBINATION, SEQUENCER, and Song play modes to set the Master Effect send level (Use the Sampling– Audio Input page in each mode to set the send level for the audio inputs.).

MIDI **Send1** responds to CC#93 and **Send2** responds to CC#91.

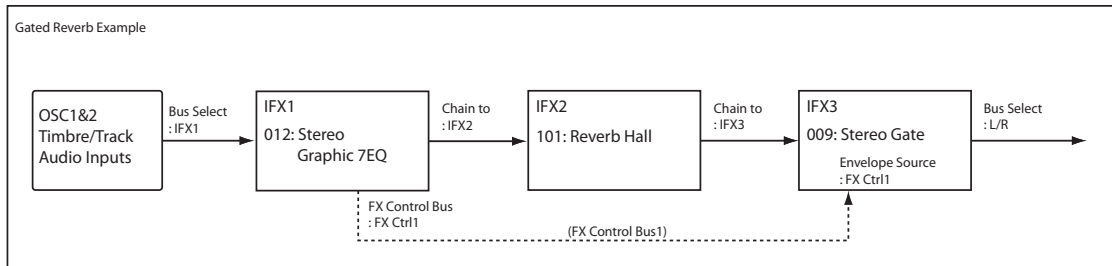

Controlling the Insert Effects via MIDI

Using the Dynamic Modulation (Dmod) function enables you to control all effect parameters in real-time during performance from the controllers of the NAUTILUS or a connected MIDI sequencer. You can also control the **Pan (CC#8)**, **Send1**, and **Send2** parameters in the same way.

Note: Since SEQUENCER mode lets you record and play exclusive messages and edit tracks that include System Exclusive events, you can use them to switch effects or modify effect parameter values during song playback.

PROGRAM and SAMPLING modes

You can control the parameters on the global **MIDI channel**.

COMBINATION mode

The IFX–IFX1–12 page lets you specify the control channel Ch (Control Channel) for IFX1–12. You can choose from CH01–16, Gch, or All Routed.

Ch01–16: Select this when you want to control each insert effect from a different channel. An “*” symbol will be displayed at the right of the MIDI channel Ch01–16 of the timbre that is routed to each insert effect. If the routed timbres have different MIDI channel settings, this parameter is used to specify the channel that will control the insert effect.

Gch: Select this option if you wish to control the parameters on the global **MIDI channel**. This is a common setting.

All Routed: Select this option to control the parameters on all the channels (channels 1–16 that have a “*” mark) that are routed to the corresponding Insert Effects.

-  If you’ve checked “Bus Select DKit” (8–1c) for a timbre for which a drum program is selected, the MIDI channel of that timbre will be valid if any IFX1–12 is set to All Routed, regardless of the drum kit’s **Bus Select (IFX/Indiv.Out Assign)** settings and the settings of the **Drum Kit IFX Patch** page menu command.

SEQUENCER mode

Use “Ch” parameters of the “IFX–IFX1–12” pages to set up the control channels for IFX1–12. Select an appropriate option from Ch01–16 and All Routed.

Ch01–16: Select this when you want to control each insert effect from a different channel. An “*” symbol will be displayed at the right of the MIDI channel Ch01–16 of the track that is routed to each insert effect. If two or more tracks with differing MIDI channels Ch01–16 are being sent to a single insert effect, this parameter is used to specify the one track that will control the insert effect.

All Routed: Select this option to control the parameters on all the channels (channels 1–16 that have a “*” mark) that are routed to the corresponding Insert Effects. “All Routed” is a typical option. If you wish to control the parameters on a single channel, you may select it from Ch01–16.

-  If you’ve checked “Bus Select DKit” for a track for which a drum program is selected, the MIDI channel of that track will be valid if any IFX1–12 is set to All Routed, regardless of the drum kit’s **Bus Select (IFX/Indiv.Out Assign)** settings and the settings of the **Drum Kit IFX Patch** page menu command.

Master Effects (MFX1, 2)

In/Out

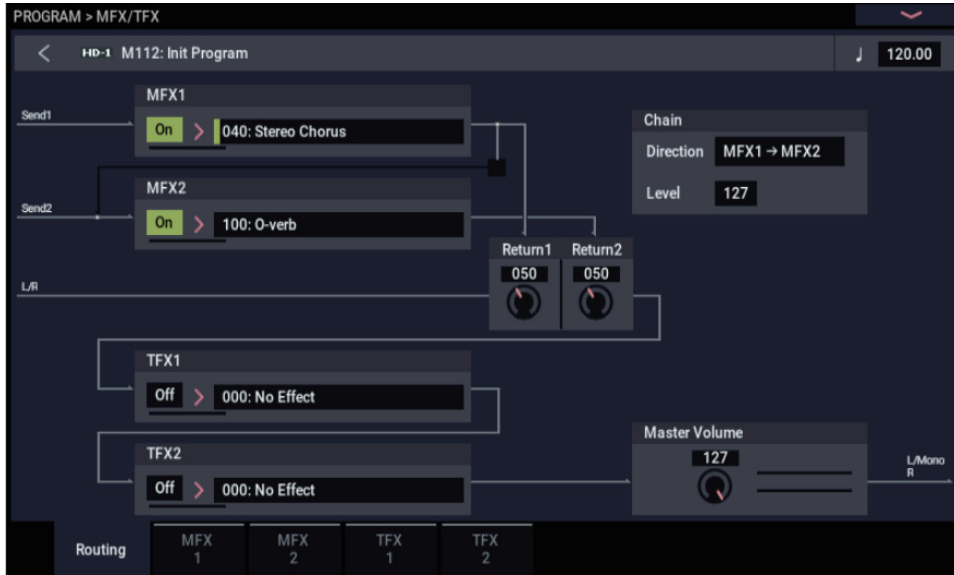

The I/Os of Master Effects MFX1 and MFX2 are stereo-in/stereo-out. **Send1** and **Send2** determine the send level to the Master Effects. (For Send1 and 2, see “Routing” and “Mixer.”)

Master effects will not output the Dry (unprocessed) signal specified in **Wet/Dry** (MFX/TFX– MFX1, 2 page). Only the Wet (processed) signal will be output. The output signals from the Master Effects are routed to the L/R bus with the output level specified by **Return1** and “Return2.” These output signals are mixed with the output signals from the bus specified by **Bus Select** (IFX– Routing page in each mode) L/R, or with the output signals from the bus specified by **Bus Select** (IFX– Insert FX page in each mode) L/R, then routed to the Master EQ.

Selecting “000: No Effect” will mute the output. The processed signal will be output in one of the following ways, according to the type of effects 001–197.

| | | |
|-----|------------------------|--|
| Wet | Mono In - Mono Out | |
| | Mono In - Stereo Out | |
| | Stereo In - Stereo Out | |

Mono–Mono Parallel

141: P4EQ//P4EQ-185: Mt.BPM Dly//Mt.BPM Dly

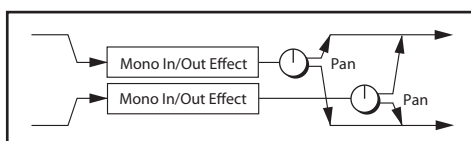

These effects are typically stereo-in/stereo-out, but they have a special structure. The L channel and R channel of the stereo input each have their own independent mono effect. Each mono output can then be panned to the desired position

in the stereo field. Normally, you will use these as insert effects, but you can also use them as master effects. For details, see “Mono–Mono Parallel Effects” on page 739.

Pressing the ON/OFF button for MFX1 and 2 of the MFX/TFX– Routing page in each mode will toggle between ON and OFF. When OFF is selected, the output signals will be muted.

MIDI Separately from the setting of this ON/OFF button, MFX1 and MFX2 can be switched off by receiving a MIDI control change CC#94. Value 0 will turn them off, and value 1–127 will turn them on. You can also use “Effect Global SW” (GLOBAL 0–1b) to turn MFX1 and 2 on and off. This MIDI control is performed on the global **MIDI channel**.

Routing

Master effects MFX1 and MFX2 can both be used in any mode. If you are not using any Insert Effects in any mode, the Master Effects send levels are determined by the **Send1 (to MFX1)** and **Send2 (to MFX2)** parameters specified independently for the oscillators (PROGRAM/SAMPLING mode), timbres (COMBINATION mode), tracks (SEQUENCER mode), and audio inputs (in all modes).

For example, since you can adjust the master effect send levels for each timbre/track, you can make settings so that reverb is applied deeply to the piano, lightly to the strings, and not at all to the bass.

If you're using insert effects, use the post-IFX **Send1** and **Send2** to adjust the send amounts.

PROGRAM mode

Use the **Send1 (to MFX1)** and **Send2 (to MFX2)** parameters of the IFX– Routing page, or the **Send1** and **Send2** parameters of the IFX– Insert FX page for the post-IFX1–12 signals, to set the Master Effect send level.

If you have set **Bus Select** to L/R or Off, **Send1 (to MFX1)** and **Send2 (to MFX2)** of the Routing page are effective. These parameters can be set for oscillators 1 and 2 individually. (Fig. 2–1a)

If you have set **Bus Select** to IFX1–12, **Send1** and **Send2** of the Insert FX page for the post-P8-IFX1–12 signals are effective. If you are using the Insert Effects in chain (series), the **Send1** and **Send2** parameters for the post-IFX (last IFX) are effective (Fig 2–1b).

If you have set **Bus Select** to 1–4 or 1/2–3/4, the oscillator signals are output directly to AUDIO OUTPUT (INDIVIDUAL) 1–4.

In this case the Send 1 and Send 2 settings are ignored, and the Master Effects will not be applied (see “Individual Outputs” on page 759).

MIDI Send1 responds to CC#93 and Send2 responds to CC#91 on the global **MIDI channel**. At this time, the actual send level uses the value of the Send 1 and 2 settings for Oscillators 1 and 2, multiplied by the Send 1 and 2 values received via MIDI.

Fig. 2–1a



Fig. 2–1b



If the Program’s **Oscillator Mode** is set to Drums, the “Use DKit Setting” box (PROGRAM 8–1b) becomes available. If you check this box, Send1 and Send2 levels for each key of the selected DrumKit become effective. If **Bus Select** is set to L/R or Off for a drum instrument key, **Send1 (to MFX1)** and **Send2 (to MFX2)** become effective.

If **Bus Select** is set to IFX1–12, the post-IFX1–12 **Send1** and **Send2** (PROGRAM 8–5a) become effective.

If this is unchecked, **Send1 (to MFX1)** and **Send2 (to MFX2)** (PROGRAM 8–1f), and the post IFX1–12 **Send1** and **Send2** (PROGRAM 8–5a) will be valid for all drum instruments, in the same way as when **Oscillator Mode** is Single or Double, or for EXi programs.

COMBINATION and SEQUENCER modes

Use **Send1 (to MFX1)** and **Send2 (to MFX2)** (IFX–Routing page) for timbres (Combination) and tracks (Sequencer) to set the Send1 and 2 levels for each timbre and track. As with PROGRAM mode, if **Bus Select** is set to L/R or Off, **Send1 (to MFX1)** and **Send2 (to MFX2)** become effective.

The actual levels use these Send1 and 2 level values, multiplied by the send level values of oscillators 1 and 2 of the PROGRAM > IFX–Routing page.

Send level

For example if you set the program’s OSC1 **Send1 (to MFX1)** to 127, **Send2 (to MFX2)** to 064, OSC2 **Send1 (to MFX1)** to 064, **Send2 (to MFX2)** to 127, and the combination’s **Send1 (to MFX1)** to 064 and **Send2 (to MFX2)** to 127, the actual send levels of the combination will be as follows.

- OSC1/EXi1 Send1=127 (100%) *064 (50%)=064 (50%)
- OSC1/EXi1 Send2=064 (50%) *127 (100%)=064 (50%)
- OSC2/EXi2 Send1=064 (50%) *064 (50%)=032 (25%)
- OSC2/EXi2 Send2=127 (100%) *127 (100%)=127 (100%)

If IFX1–12 is selected for **Bus Select**, use the **Send1** and **Send2** parameters for the post-IFX signals. If 1–4 or 1/2–3/4 is selected instead, these Send1 and 2 settings are ignored and the Master Effect is not applied.

MIDI Send1 responds to CC#93, and Send2 responds to CC#91. If **Send1 (to MFX1)** and **Send2 (to MFX2)** for each timbre/track are effective, the parameter will be controlled on the MIDI channels set for the corresponding timbres and tracks. If the **Send1** and **Send2** parameters for the post-IFX1–12 signals are effective, they can be controlled on the MIDI channels assigned to IFX1–12.

An example for COMBINATION mode is given below. In the upper figure (Fig. 2–2a), **Bus Select** is set so that Timbre 1 is routed to IFX1, Timbre 2 to IFX2, Timbre 3 to IFX3, Timbre 4 to IFX4, Timbres 5 and 6 to IFX5, and Timbres 7 and 16 to L/R. In this case, use **Send1** and **Send2** for the post-IFX1 (001:St. Dyna Compressor) signal to set the send level of the Timbre 1 routed to the Master Effect. (In this example they are set to 032 and 127.) In the same way, use **Send1** and **Send2** for the post-IFX2, 3, and 4 signals to set the send levels of Timbres 2, 3, and 4, and use the **Send1** and **Send2** parameters for the post-IFX5 signal to set the send levels of Timbres 5 and 6. For Timbres 7 and 16, the settings of **Send1 (to MFX1)** and **Send2 (to MFX2)** will be

effective. (At this time, the actual send levels use these Send 1 and 2 values multiplied by the Send 1 and 2 settings for Program oscillators 1 and 2.)

“Bus Select DKit” is valid if you’ve selected a drum track for a Timbre (Combination) or Track (Sequencer).

Fig. 2–2a

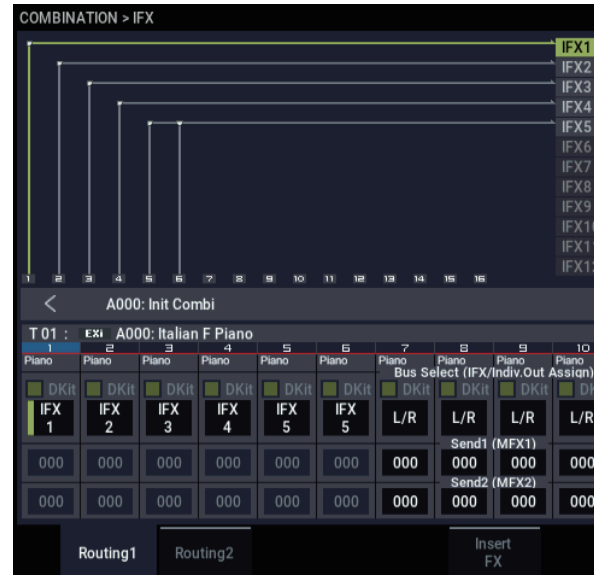

If you select **DKit**, the **Bus Select** settings for each key become effective, and each drum instrument sound will be routed to the corresponding buses. At this time, the actual send levels use these Send 1 and 2 values, multiplied by the Send1 and 2 settings for each DrumKit key.

If a drum kit’s **Bus Select** is set to L/R or Off, the levels will be these Send 1 and 2 settings multiplied by the send levels you specify in PROGRAM > IFX–Routing page for OSC1 **Send1 (to MFX1)** and **Send2 (to MFX2)** (PROGRAM 8–1d), just as in other cases (**Oscillator Mode** Single or Double).

If **Bus Select** is set to IFX1–12, use **Send1** and **Send2** for the post-IFX signal. If **Bus Select** is set to 1–4 or 1/2–3/4, the Send 1 and 2 settings will be ignored.

Fig. 2–2b



SAMPLING mode

You can apply insert effects, master effects, and total effects to an external audio source (analog or USB), and sample the result. You can also apply insert effects, master effects, and total effects to samples assigned to a multisample, and resample the result.

Use the Recording– Audio Input page to make settings for external audio sources.

The **Bus Select** setting for each jack specifies the bus to which the external input source will be sent. You can choose from L/R, IFX1–12, 1–4, 1/2–3/4, or Off. If **Bus Select** is set to L/R or Off, use **Send1 (to MFX1)** and **Send2 (to MFX2)** to adjust the send levels to the master effects. If **Bus Select** is set to IFX1–12, use the post-IFX **Send1** and **Send2** to adjust the send levels to the master effects.

If you want to apply the master effects to the samples of a multisample and play or resample the result, use the IFX– Routing page settings **Send1 (to MFX1)** and **Send2 (to MFX2)** or the IFX– Insert FX page settings post-IFX1–12 **Send1** and **Send2** settings to adjust the send levels to the master effects.

 **MIDI** Send1 can be controlled by receiving CC#93, and Send2 by receiving CC#91. These parameters are controlled on the global **MIDI channel**.

Audio Input, USB

In PROGRAM, COMBINATION, SEQUENCER, and MEDIA modes, external audio sources from the audio inputs (analog, S/P DIF, and USB) can be processed by insert effects, master effects, and total effects just as they can in SAMPLING mode.

In the Home– Sampling page of each mode, the **Use Global Settings** parameter makes settings for all of the audio inputs (analog and USB).

Set **Bus Select** to specify the bus to which the external audio input will be sent. You can select L/R, IFX1–12, 1–4, 1/2–3/4, or Off. If **Bus Select** is set to L/R or Off, adjust the send levels to the master effects using **Send1 (to MFX1)** and **Send2 (to MFX2)**. If **Bus Select** is set to IFX1–12, use the post-IFX **Send1** and **Send2**. If this is set to individual outputs 1–4 or 1/2–3/4, the signal will not be sent to the master effects.

 In MEDIA mode, effects will use the settings of the mode in which you previously were.

Mixer

The input levels to the master effects are determined by the send levels. In the MFX/TFX– Routing page of each mode, you can specify the output level and chaining (series connection) between the two master effects.

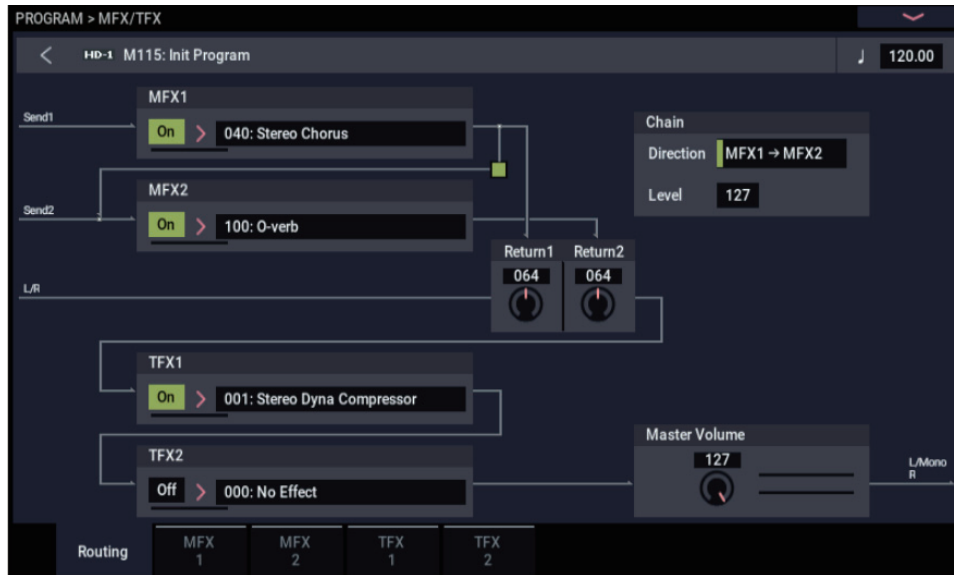

Return1, Return2

These adjust the amount of signal that is returned from the master effects MFX1 and MFX2 outputs to the L/R bus.

The left-side value of the **Wet/Dry** parameter for the MFX1 or 2 effect is the output level of that master effect. (In other words if **Wet/Dry** is 25:75, the output level is 75%. It is 100% if Wet, and 0% if Dry.) The **Wet/Dry** value multiplied by the **Return1** or **Return2** value is sent to the L/R bus and mixed with the IFX– Routing page **Bus Select** L/R or Insert FX page **Bus Select** L/R output.

For example, with MFX1 **Wet/Dry** set to 50:50 (50%) and **Return1** set to 64 (50%), the resultant effect level will be 25%. The effect level is maximum (100%) when **Wet/Dry** is set to “Wet” and **Return1** is set to 127.

Chain check box

Press this box to chain MFX1 and MFX2 to each other.

In the example shown in the preceding page, the output of MFX1 (Stereo Chorus) is added to the input of MFX2 (Reverb Hall).

Chain Direction

If you have checked the **Chain** box, you can set the direction of the connection here. You can also visually confirm the direction on the LCD.

Chain Level

This parameter determines the level of signals routed from one MFX to the other MFX in a chain connection.

Controlling the Master Effects via MIDI

In the same way as for insert effects, parameters of the master effects can also be controlled in realtime via Dynamic Modulation (Dmod) from the NAUTILUS's controllers or an external MIDI device during performance or from the sequencer.

PROGRAM and SAMPLING modes

Effect parameters are controlled on the global **MIDI channel**.

COMBINATION and SEQUENCER modes

In COMBINATION and SEQUENCER modes, the control channel for MFX1 and MFX2 are specified by the Ch (Control Channel) setting in the MFX1 and 2 pages. You can choose Ch01–16 or Gch.

Ch01–16: Select this option if you wish to control the parameters for each Master Effect on different channels.

Gch: Select this option if you wish to control the parameters on the global **MIDI channel**. This is the normal setting.

Note: Since SEQUENCER mode lets you record and play exclusive messages and edit tracks that include System Exclusive events, you can use them to switch effects or modify effect parameter values during song playback.

Total Effects (TFX1, 2)

In/Out

The total effects TFX1 and TFX2 are stereo-in and stereo-out. The Dry (unprocessed) side of the **Wet/Dry** parameter sends the stereo input sound directly to the stereo output. The way in which the Wet (processed) side is output depends on the type of effect, as follows.

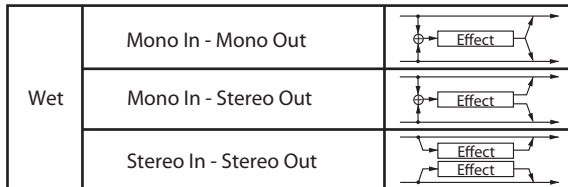

If you select 000:No Effect, the stereo input will be passed to the stereo output without any processing.

You can switch the effects on/off using the MFX1 or 2 ON/OFF buttons or the MFX/TFX– Routing settings in each mode. When off, the effect will be bypassed. The stereo input will be passed to the stereo output without any processing, just as if 000:No Effect is selected.

MIDI Separately from this ON/OFF button, MIDI control change CC#95 can be received to turn TFX1 and TFX2 off. A control change value of 0 turns them off, and a value of 1–127 restores them to the prior setting. You can also use “Effect Global SW” to turn off TFX1 and TFX2 in the same way. This is controlled on the global **MIDI channel**.

Mono–Mono Parallel

141: P4EQ//P4EQ-185: Mt.BPM Dly//Mt.BPM Dly

For details, see “Mono–Mono Parallel Effects” on page 739.

Routing

The total effects TFX1 and TFX2 are placed immediately before the AUDIO OUTPUT (MAIN) L/MONO and R outputs. Both effects (TFX1 and 2) are available in all modes.

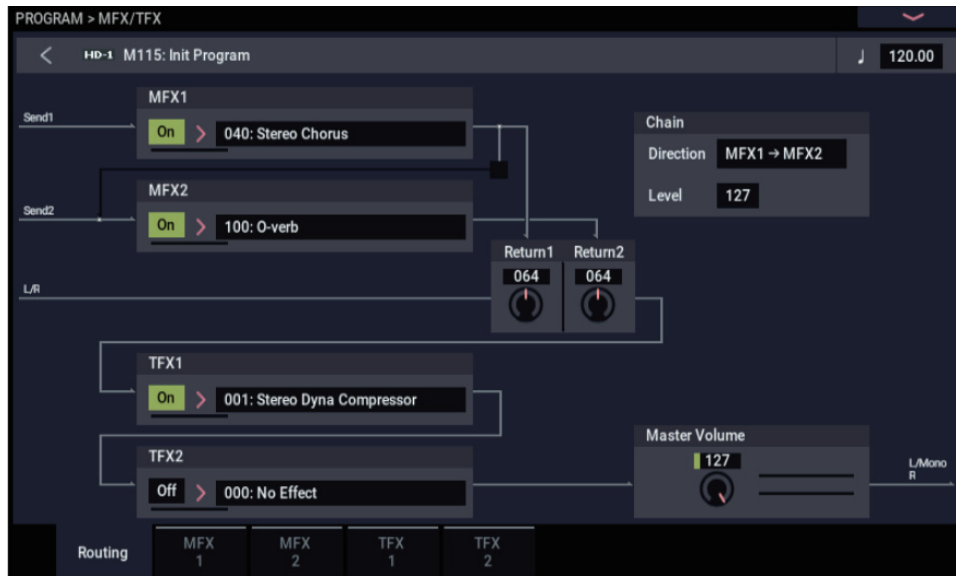

If the **Bus Select** setting for an oscillator (PROGRAM/SAMPLING modes), timbre (COMBINATION mode), track (SEQUENCER mode), or audio input (in all modes) or the post-insert **Bus Select** is set to L/R, the signal will be output from the AUDIO OUTPUT (MAIN) L/MONO and R jacks.

The sound from MFX1 and 2 is routed through TFX1 and TFX2, and then output to AUDIO OUTPUT (MAIN) L/MONO and R.

Mixer

Master Volume

This sets the level of the final output after passing through the total effects.

Using MIDI to control the Total Effects

In the same way as for Insert and Master Effects, the Total Effects can be controlled in realtime via Dynamic Modulation (Dmod). You can use either the built-in NAUTILUS's controllers or an external MIDI device, during live performance or from a sequencer.

PROGRAM and SAMPLING modes

Effect parameters are controlled on the global **MIDI channel**.

COMBINATION and SEQUENCER modes

In COMBINATION and SEQUENCER modes, the control channel for TFX1 and TFX2 are specified by the Ch (Control Channel) setting in the TFX1 and 2 pages. You can choose Ch01–16 or Gch.

Ch01–16: Choose from these settings if you want to control each total effect on a separate channel.

Gch: Choose this setting if you want to control the total effects on the global **MIDI channel**.

Note: In SEQUENCER mode, you can record and play back exclusive messages, and edit tracks that include System Exclusive events. This lets you switch effects or vary the value of effect parameters while a song plays.

Outputs

Main Outputs

The main L/MONO and R outputs of the NAUTILUS are output from the AUDIO OUTPUT (MAIN) L/MONO and R jacks, and the headphone jack.

Individual Outputs

The NAUTILUS is equipped with four individual audio outputs, which can be used as individual mono outputs, stereo pairs, or any combination of the two. Almost any signal source can be routed to these outputs, including:

- Each note in a Drum Kit
- Insert Effect outputs
- Each Program in a Combination or Song
- Audio tracks
- Audio inputs

You can use these to isolate or group together sounds for recording, or for complex live performance setups.

If the signal is going through one or more insert effects, the output is set at the last IFX in the chain, via the **Bus Select** parameter on the IFX– Insert Effects page.

If a Program, Timbre, or Track is *not* going through any insert effects, the output is set using the **Bus Select** parameters on the IFX– Routing page.

To assign audio inputs directly to outputs, use **Bus Select** parameters in the Sampling– Audio Input page.

In GLOBAL mode, the Audio page **L/R Bus Indiv. Assign** setting lets you mirror the MAIN stereo L/R output on any pair of individual outputs. You can use this to create a private monitoring setup in live and studio environments. For more information, see “L/R Bus Indiv. Assign” on page 638 of the Parameter Guide.

Note: You can’t use the VOLUME knob to adjust the volume of the individual outputs.

Effect/Mixer Block Diagrams

PROGRAM mode

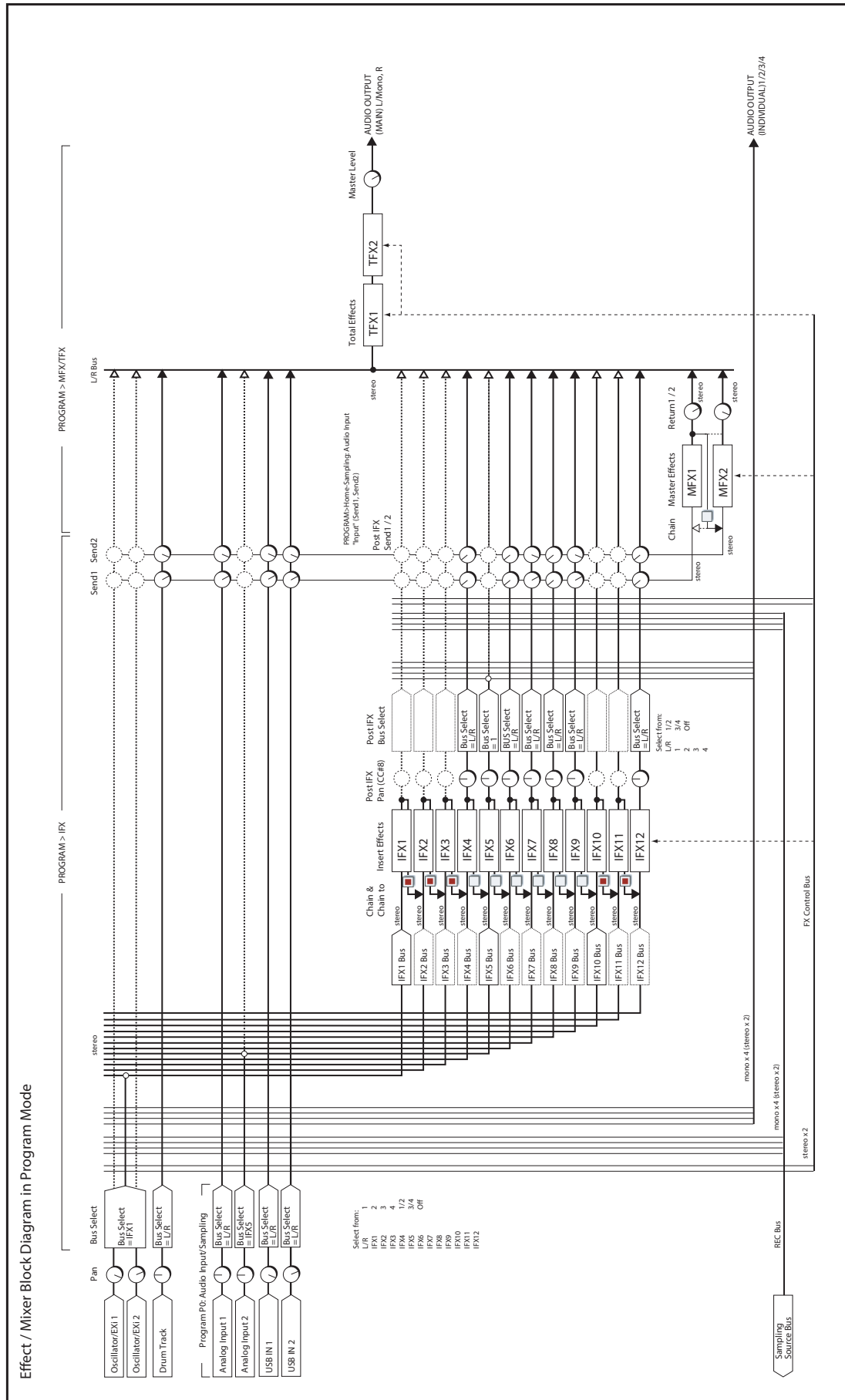

COMBINATION mode, SEQUENCER mode

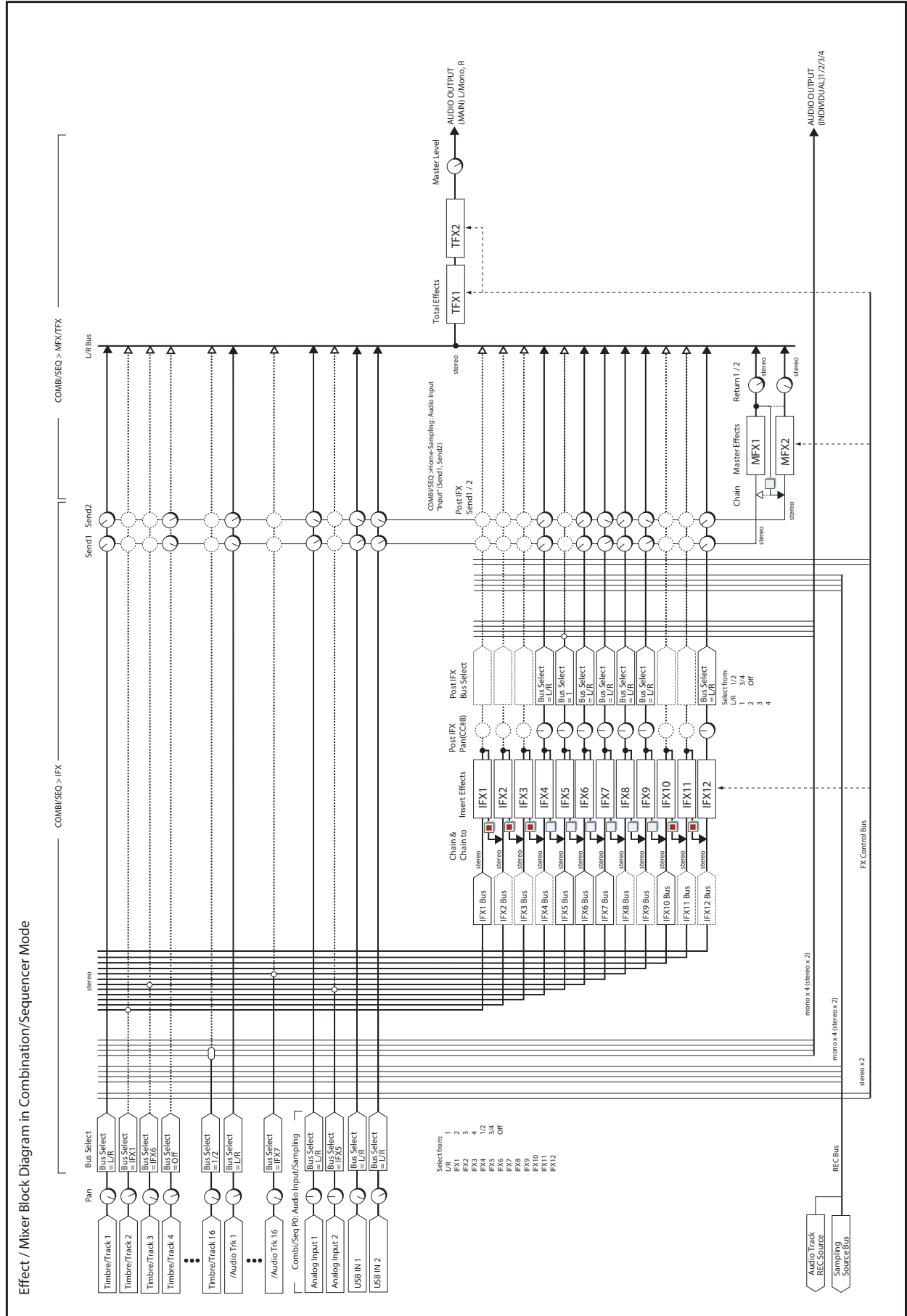

SAMPLING mode

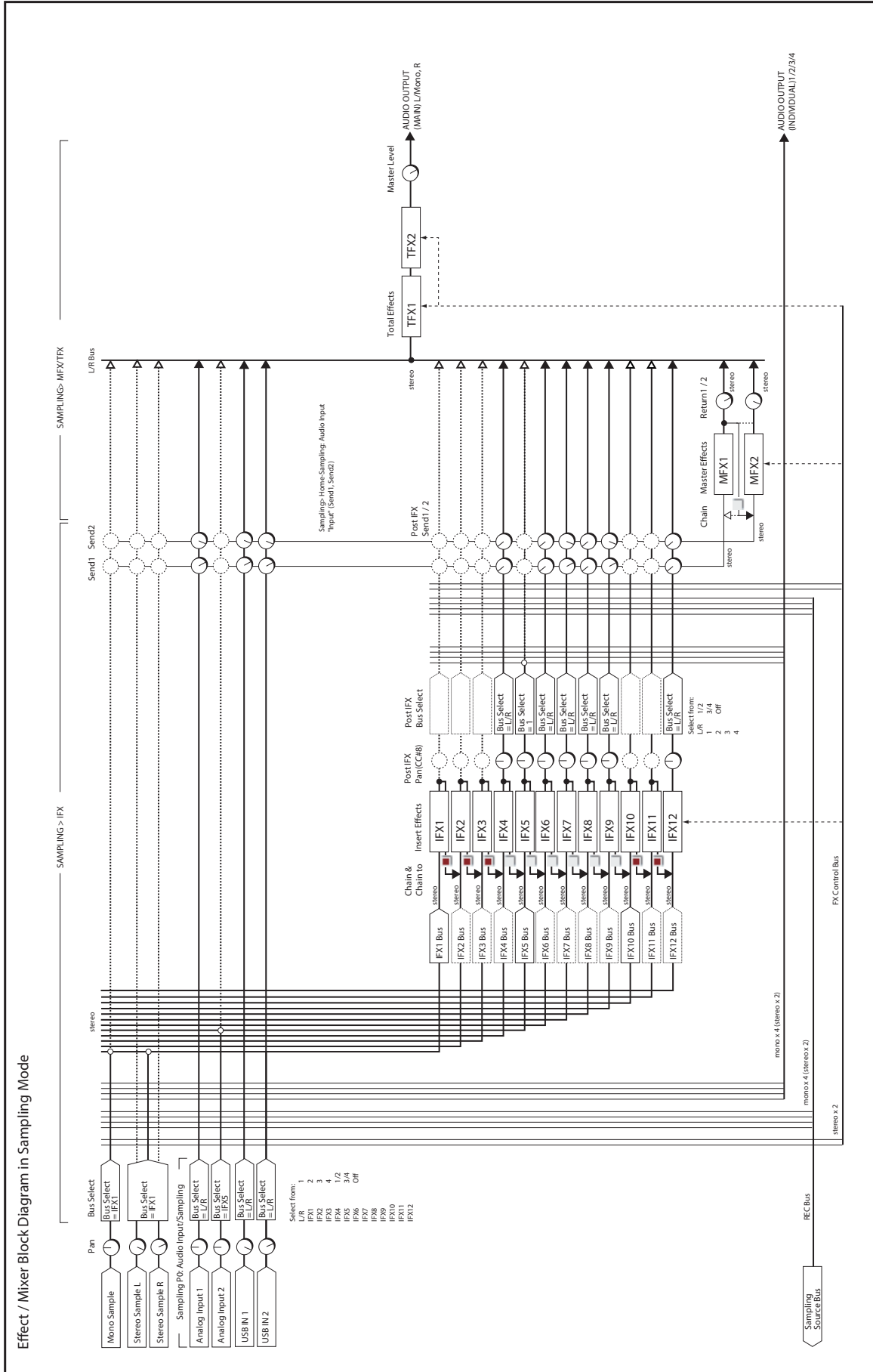

Dynamics

000: No Effect

Choose this option when you are not using the selected effects slot. This frees up processing resources for other effects and/or synth voices.

When a slot is set to **No Effect**:

- Insert Effects and Total Effects pass through the dry, unprocessed signal
- Master Effects mute their outputs

001: Stereo Dyna Compressor

On-screen graphic, 001 Stereo Dyna Compressor

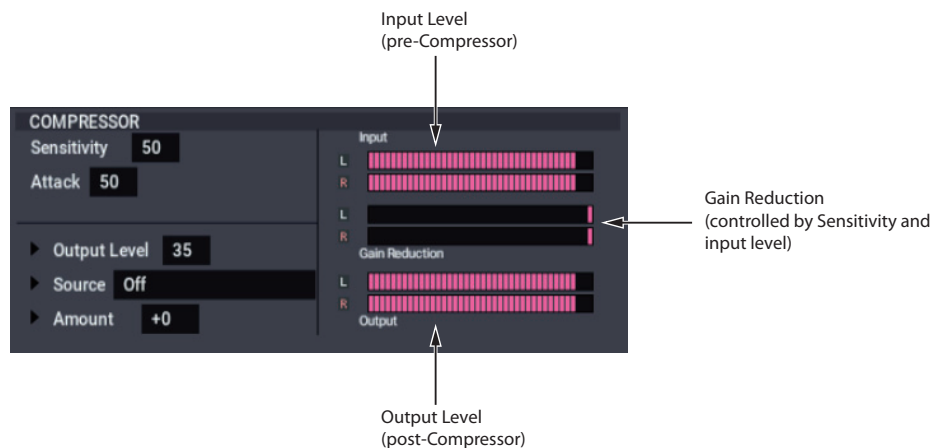

This effect reduces the dynamic range of the input signal, to regulate the level and give a “punchy” effect. It is useful for guitar, piano, and drum sounds. This is a true stereo effect; you can link the left and right channels, or use each channel separately.

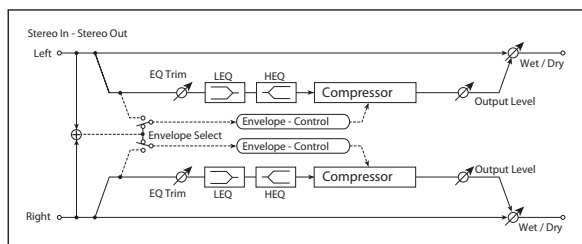

ENVELOPE

Select [L/R Mix, L/R Individually]

This determines how the left and right channels of the selected **Source** are used for controlling the compressor. Note that this applies only to the control signal; the effect always processes both channels of the input signal in stereo.

L/R Mix is generally the best choice for stereo signals; this compresses both channels equally, based on the combined volumes of the left and right channels.

L/R Individually splits the effect into two separately controlled mono compressors. When processing stereo signals, this will cause the stereo image to shift.

Pre EQ

Trim [0...100]

This sets the input level for the EQ.

LEQ Fc [Low, Mid-Low]

Selects the frequency of the EQ’s low band.

LEQ Gain [dB] [-15.0...+15.0]

Sets the gain of the Low EQ.

HEQ Fc [High, Mid-High]

Selects the frequency of the EQ’s high band.

HEQ Gain [dB] [-15.0...+15.0]

Sets the gain of the High EQ.

COMPRESSOR

Sensitivity [1...100]

This controls the amount of compression. Increasing the value boosts lower level sounds, and raises the overall volume.

To adjust the final volume, use the **Output Level** parameter.

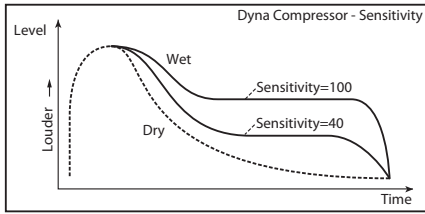

Attack

[1...100]

This controls the onset time of the compressor.

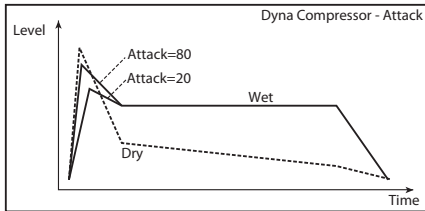

Output Level D_{mod} [0...100]

Sets the output level of the compressor.

Source [Off...Tempo]

Selects the modulation source for the **Output Level**.

Amount [+/-100]

Sets the modulation amount for the **Output Level**.

OUTPUT

Wet/Dry D_{mod} [Dry, 1:99...99:1, Wet]

Sets the balance between the “wet” processed sound and the dry input.

Source [Off...Tempo]

Selects a modulation source for **Wet/Dry**.

Amount [+/-100]

Sets the modulation amount for **Wet/Dry**.

002: Stereo Compressor

On-screen graphic, 002 Stereo Compressor

The yellow line shows the output level, relative to the input level. This will change according to the Ratio, Threshold, and Soft Knee Width.



This meter shows the amount of gain reduction, in real-time. To show that the gain is being reduced, the meter moves in the opposite direction from the Input meter.

The red marks show the Threshold setting.

The light gray area shows the Soft Knee Width. Notice how the slope of the yellow line changes as it passes through this range.

The red marks show the Threshold setting.

These lights show the relation of the control input to the Threshold and Soft Knee, in real-time. Under (green) means the input is below the Soft Knee area, and so no compression is occurring. Knee (yellow) means that the input is within the Soft Knee range. Within this range, as the signal gets louder, the amount of compression will gradually increase towards the Ratio setting. Over (red) means that the input is above the Soft Knee range, and the full Ratio is being applied.

This is a sophisticated stereo compressor that allows you to make detailed settings, such as the level detection method and the compression curve.

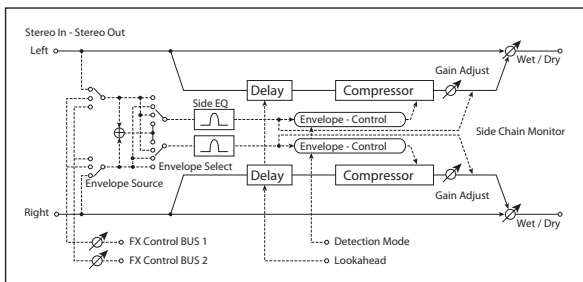

ENVELOPE

Source [Input, FX Control 1, FX Control 2]

The action of the compressor is controlled by the level of the selected **Source**.

Input is the normal setting, in which the level of the input signal controls the compressor.

FX Control 1 or **2** let you process the input signal with the compressor, while using a completely different signal to control it. For instance, you might use a different Timbre or Track to duck the input signal. For more information, please see “FX Control Buses” on page 735.

Select [L/R Mix, Left, Right, L/R Individually]

This determines how the left and right channels of the selected **Source** are used for controlling the compressor. Note that this parameter applies only to the control signal; the effect always processes both channels of the input signal in stereo.

L/R Mix is generally the best choice for stereo signals; this compresses both channels equally, based on the combined volumes of the left and right channels.

L Only and **R Only** use only the selected channel for controlling the limiter; the other channel is ignored.

L/R Individually splits the effect into two separately controlled mono compressors. When processing stereo signals, this will cause the stereo image to shift.

Fx Control Trim [0...100]

This adjusts the level of the FX Control Bus inputs.

Detection Mode [RMS, Peak]

RMS bases the amount of compression on the average level, which tends to sound more natural in most cases.

Peak does not do this averaging, and so the compressor responds more quickly to sudden jumps in level.

Choose **RMS** if you want to make the overall volume more consistent, or choose **Peak** if you want to be sure that even sudden peaks are suppressed.

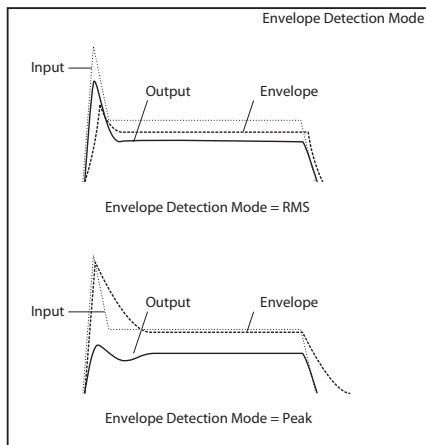

Side Chain Monitor [Check-box]

When this is **On**, you'll hear the control signal (as selected by the **Source** parameter) through the sidechain EQ, instead of the output of the limiter. This can be helpful when you're tuning the EQ to emphasize or de-emphasize specific frequencies.

To hear the output of the limiter, set this to **Off**.

SIDE CHAIN EQ

This multimode filter applies only to the control signal, and not to the main audio path. Use it to alter the response of the compressor so that it reacts (or does not react) only to specific frequencies.

For instance, if you want the compressor to ignore cymbal crashes, adjust the sidechain EQ to reduce the gain of frequencies specific to the cymbals. While doing so, it may help to turn on the **Side Chain Monitor** switch, so that you can listen as you hone in on the desired frequencies.

EQ On [Check-box]

Switches the EQ on and off.

Type [Low Pass, Band Pass, High Pass, Band Reject]

Selects the type of filter for the sidechain. For more information, see "Filter Type" on page 63.

Frequency [Hz] [20...20.00k]

Sets the filter's cutoff frequency.

Q [0.5...10.0]

Sets the bandwidth of the EQ.

COMPRESSOR

Ratio [1.0:1...50.0:1, Inf:1]

This determines how strong the effect of the compressor will be, expressed by how many dB in input level over the **Threshold** is required for a 1dB change in output level.

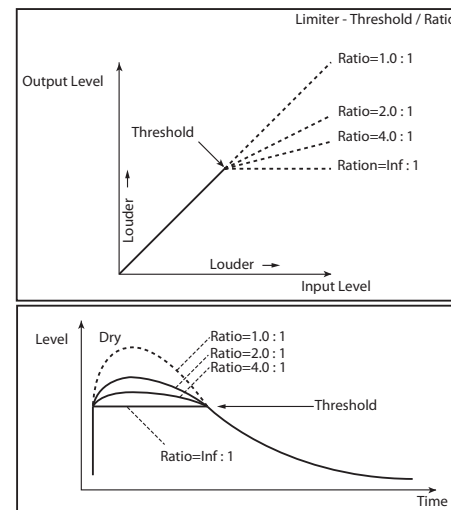

At **1.0:1**, the compressor has no effect. At **20.00:1**, a 20dB increase in the input level (over the **Threshold**) results in only a 1dB change in output. At **Inf:1**, the compressor becomes a brick-wall limiter; once the signal hits the **Threshold**, the output level will no longer increase, regardless of the input level.

Threshold [dB] [-40...0]

Compression happens only when the input signal exceeds this level. Input levels above the threshold will be compressed, and input levels below the threshold will not be compressed.

Soft Knee Width [dB] [0...30]

Increasing this value will produce a more gentle volume change around the **Threshold** level.

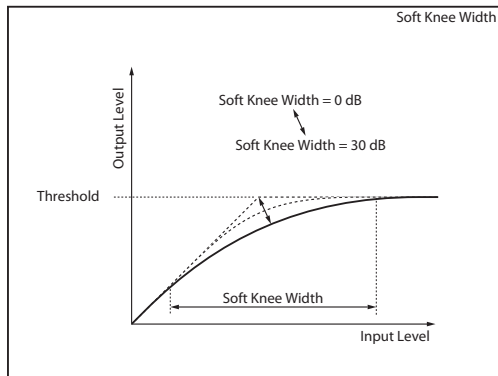

Attack [msec] [0.45...500.0]

This determines how quickly the compressor will take affect after the signal crosses above the threshold.

Release [msec] [5...5000]

This controls how quickly the compressor will stop reducing volume level after the signal falls below the threshold.

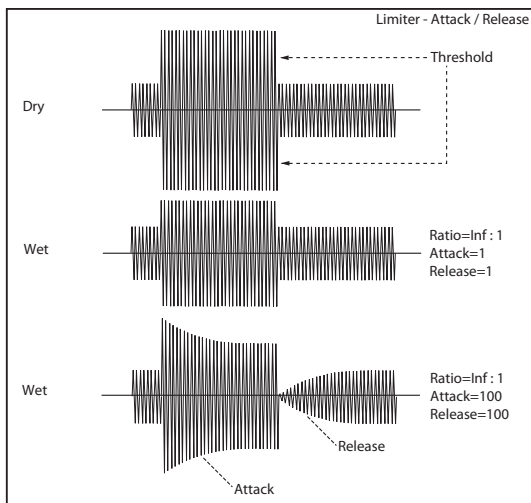

Lookahead [Check-box]

If this is on, the input signal to the compressor is delayed so that the level will be detected from the trigger input before the input signal is actually processed. This allows compression to accurately follow changes in the trigger input.

Gain Adjust [dB] D_{mod} [-Inf, -38...+24]

Sets the output gain. It's often useful to increase the gain, since compression causes the entire level to be reduced.

Source [Off...Tempo]

Selects the modulation source for the output gain.

Amount [-63...+63]

Sets the amount of output gain modulation.

OUTPUT

This is the standard effects output section, with modulatable control over wet/dry balance. For more information, see "OUTPUT" on page 764.

003: Stereo Expander

On-screen graphic, 003 Stereo Expander

The yellow line shows the output level, relative to the input level. This will change according to the Ratio, Threshold, and Soft Knee Width. The expander lowers the level when the input signal is below the Threshold, to the left of the gray area. In the example shown here, a -30 dB input results in -40 dB output, while a -5 dB input passes through unchanged.

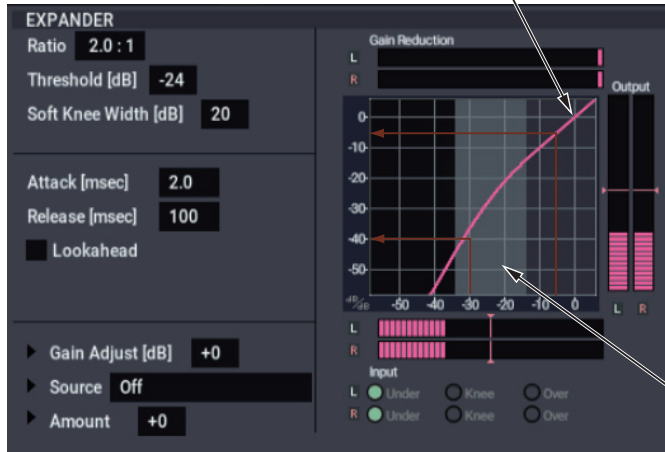

Please see the description of the Stereo Compressor for more information on the graphic display.

The light gray area shows the Soft Knee Width. Notice how the slope of the yellow line changes as it passes through this range.

An expander is like the opposite of a compressor: it makes quiet signals more quiet. You can use this to increase dynamic range, emphasizing the differences between soft and loud.

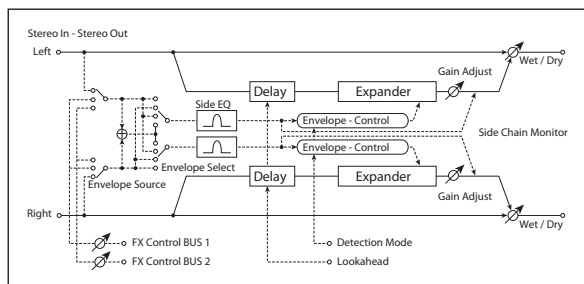

ENVELOPE

This part of the effect allow you to select and listen to the control signal, adjust the input level of the FX Control Buses, and select between RMS and Peak detection modes. The parameters are the same as for the Stereo Compressor; for more information, see “ENVELOPE” on page 764.

SIDE CHAIN EQ

This multimode filter applies only to the control signal, and not to the main audio path. Use it to alter the response of the expander so that it reacts (or does not react) only to specific frequencies. The parameters are the same as for the Stereo Compressor; for more information, see “SIDE CHAIN EQ” on page 765.

EXPANDER

Ratio [1.0:1...10.0:1]

Sets the signal compression ratio.

Threshold [dB] [-40...0]

Sets the level above which the compressor is applied. For more information, see “Threshold [dB]” on page 765.

Soft Knee Width [dB] [0...30]

Sets the curve at which compression is applied. p.765.

Attack [msec] [0.45...500.0]

Sets the attack time. For more information, see “Attack [msec]” on page 766.

Release [msec] [5...5000]

Sets the release time. For more information, see “Release [msec]” on page 766.

Lookahead [Check-box]

Switches level detection look-ahead (expander input delay) on/off. For more information, see “Lookahead” on page 766.

Gain Adjust [dB] [-Inf, -38...+24]

Sets the output gain.

Source [Off...Tempo]

Selects the modulation source for the output gain.

Amount [-63...+63]

Sets the modulation amount of the output gain.

OUTPUT

This is the standard effects output section, with modulatable control over wet/dry balance. For more information, see “OUTPUT” on page 764.

004: St.Multiband Compressor

On-screen graphic, 004 St. Multiband Compressor crossover

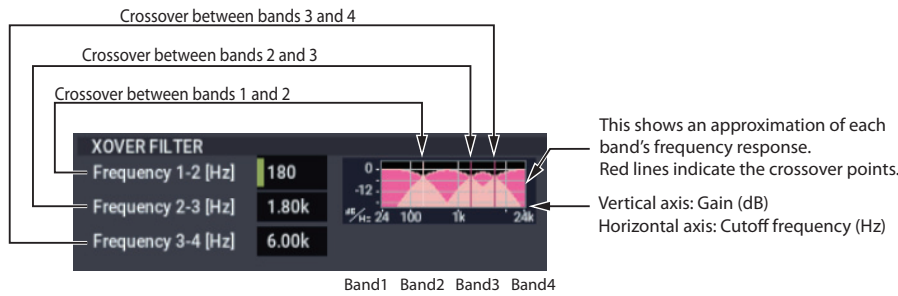

This stereo effect divides the input signal into four bands, low through high, with separate dynamics control of each band. While it's named a "compressor," it's actually much more than that. It can be used as a compressor, expander, gate, or EQ—with each band performing a different function, if desired.

The dynamics processing works somewhat differently than a standard compressor/expander. For more information, see "Range [dB]," below.

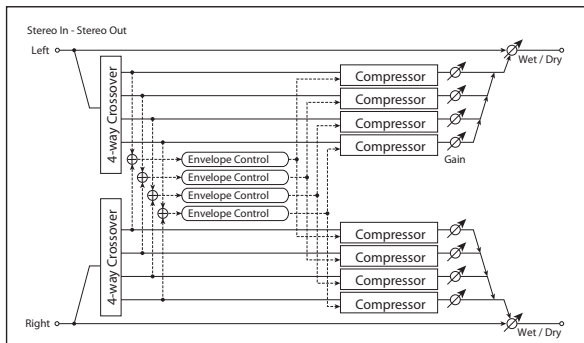

XOVER FILTER

Slope [6dB Oct, 12dB Oct, 18dB Oct, 24dB Oct]

Selects the steepness of the crossover filters.

Frequency 1-2 [Hz] [40...240]

Sets the frequency at which bands 1 and 2 are divided.

Frequency 2-3 [Hz] [100...6.00k]

Sets the frequency at which bands 2 and 3 are divided.

Frequency 3-4 [Hz] [2.00k...16.00k]

Sets the frequency at which bands 3 and 4 are divided.

ADJUST

Knee [Soft, 0.01...0.74, Hard]

This effectively controls both the onset/offset shape of the dynamics processing, and (in conjunction with **Range**), the compression/expansion ratio.

For more information, see "Range [dB]," below.

Output Gain [dB] [-18.0...+18.0]

Sets the overall output gain.

Bands 1-4

Each of the four bands has identical parameters.

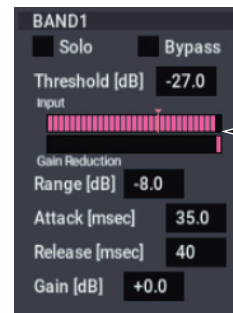

These meters show the band's input level and gain reduction, in real-time. The red mark shows the Threshold setting.

Solo

[Check-box]

Use this setting to audition the processed sound of each band.

If this is On, the output of other bands will be muted. If this is On for more than one band, only the bands for which this is On will be heard. Normally, this should be turned Off for all bands.

Bypass

[Check-box]

You can bypass compression for each band individually.

When this is On, you'll hear the band's un-compressed signal.

Threshold [dB]

[-80.0...0.0]

The compression/expansion functions only in a range around the **Threshold** level. Signals outside of this range are not affected.

For more information, see "Range [dB]," below.

Range [dB]

[-24.0...+18.0]

The combination of **Threshold** and **Range** controls the band's basic functionality (traditional compressor, low-level expander, etc.), and the combination of **Range** and **Knee** creates the band's compression/expansion.

To create a traditional compressor action, set the **Threshold** around 0.0, and the **Range** to a negative value.

To create a low-level expander (raising lower volume levels, while leaving higher levels untouched), set the **Threshold** to a low level, and the **Range** to a positive value.

You can also create special compression effects, such as compressing (or expanding) only the middle range of levels. For more information, see the diagram below.

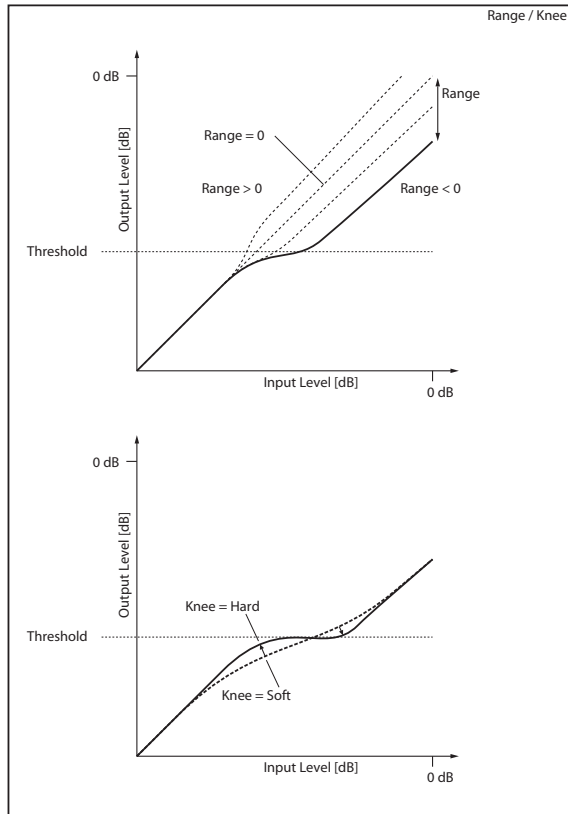

Attack [msec] [0.60...500.0]

Sets the band's attack time. For more information, see "Attack [msec]" on page 766.

Release [msec] [5...5000]

Sets the band's release time.

Gain [dB] [-18.0...+18.0]

Sets the band's output gain.

OUTPUT

This is the standard effects output section, with modulatable control over wet/dry balance. For more information, see "OUTPUT" on page 764.

005: Stereo Limiter

On-screen graphic, 005 Stereo Limiter

The yellow line shows the output level, relative to the input level. This will change according to the Ratio and Threshold settings. Input above the Threshold will be compressed. In the example shown here, a -10 dB input will result in -20 dB output.

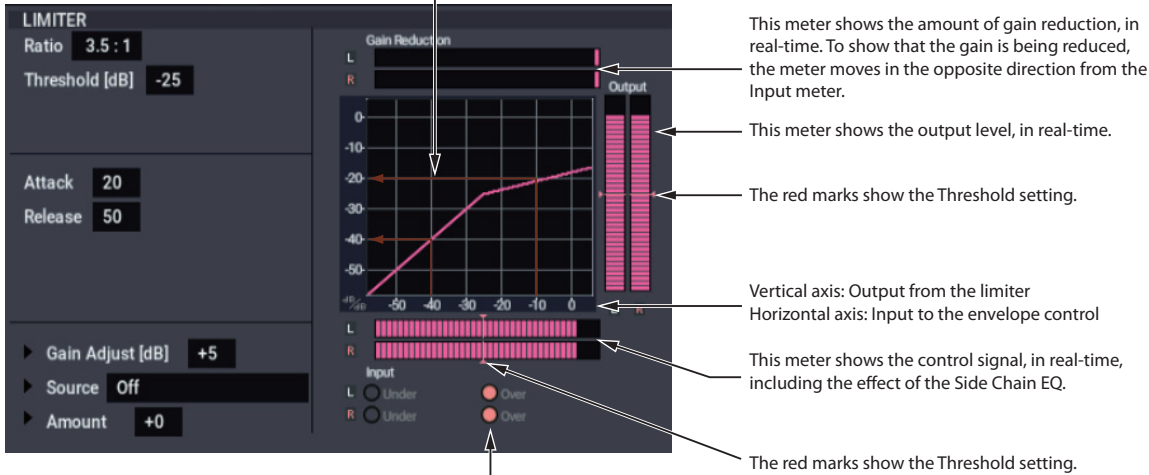

These lights show the relation of the control input to the Threshold, in real-time. Under (green) means the input is below the Threshold, and so the signal will pass through unchanged. Over (red) means that the input is above the Threshold, and so the signal will be limited.

The Limiter regulates the input signal level. It is similar to the Compressor, except that the Limiter compresses only signals that exceed the specified level to lower unnecessary peak signals. The Limiter applies a peaking-type EQ to the trigger signal (which controls the degree of the Limiter effect), allowing you to set any band width to be covered. This is a true stereo effect; you can link left and right channels, or use each channel individually.

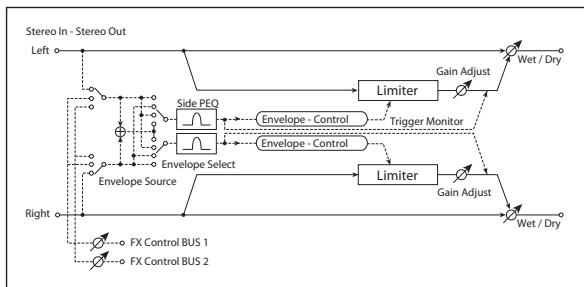

ENVELOPE

Source [Input, FX Control 1, FX Control 2]

This selects the control signal for the limiter: the input signal, FX Control Bus 1, or FX Control Bus 2. For more information, see “Source” on page 764.

Select [L/R Mix, L Only, R Only, L/R Individually]

This determines how the left and right channels of the selected **Source** are used. Note that this parameter applies only to the control signal; the effect always processes both channels of the input signal in stereo. For more information, see “Select” on page 765.

L/R Mix is generally the best choice for stereo signals; this will cause the limiting to be applied equally to both channels, based on the combined volumes of the left and right channels.

L Only and **R Only** use only the selected channel for controlling the limiter; the other channel is ignored.

L/R Individually essentially splits the stereo limiter into two separately controlled mono limiters. When processing stereo signals, this will cause the stereo image to shift.

FX Control Trim [0...100]

This adjusts the level of the FX Control Bus inputs.

Side Chain Monitor [Check-box]

This lets you listen directly to the control signal (as selected by the **Source** parameter) through the sidechain EQ. See “Side Chain Monitor” on page 765.

SIDE CHAIN EQ

This EQ applies only to the control signal, and not to the main audio path. Use it to alter the response of the limiter so that it reacts (or does not react) only to specific frequencies.

For instance, if you want the limiter to ignore cymbal crashes, adjust the sidechain EQ to reduce the gain of frequencies specific to the cymbals. While doing so, it may help to turn on the **Side Chain Monitor** switch, so that you can listen as you hone in on the desired frequencies.

Side PEQ On [Check-box]

This lets you enable and disable the sidechain EQ—handy for comparing its effect.

Fc [Hz] [20...12.00k]

Sets the EQ center frequency for the control signal.

Q [0.5...10.0]

Sets the EQ bandwidth for the control signal.

Gain [dB] [-18.0...+18.0]

Sets the EQ gain for the control signal.

LIMITER

Ratio [1.0:1...50.0:1, Inf:1]

Sets the signal compression ratio. For more information, see “Ratio” on page 765.

Threshold [dB] [-40...0]

Sets the level above which the compressor is applied. For more information, see “Threshold [dB]” on page 765.

Attack [1...100]

Sets the attack time. For more information, see “Attack [msec]” on page 766.

Release [1...100]

Sets the release time. For more information, see “Release [msec]” on page 766.

Gain Adjust [dB] [-Inf, -38...+24]

Sets the output gain. For more information, see “Gain Adjust [dB]” on page 766.

Source [Off...Tempo]

Selects the modulation source for the output gain.

Amount [-63...+63]

Sets the modulation amount of the output gain.

OUTPUT

This is the standard effects output section, with modulatable control over wet/dry balance. For more information, see “OUTPUT” on page 764.

006: Multiband Limiter

On-screen graphic, 006 Multiband Limiter

The yellow line shows the output level, relative to the input level. This will change according to the Ratio and Threshold settings.

The screenshot shows the 006 Multiband Limiter interface. At the top, there are global settings: Ratio (3.5:1), Threshold (-25 dB), Attack (20), and Release (50). A central graph plots input level (dB) on the x-axis from -50 to 0 and output level (dB) on the y-axis from -50 to 0. A red line represents the threshold, and a yellow line represents the output level. Below the graph are three frequency bands: LOW, MID, and HIGH. Each band has an 'Offset [dB]' control (all set to 0) and a meter showing 'Input' and 'Gain Reduction'. Annotations include: a yellow arrow pointing to the yellow line in the graph; a red arrow pointing to the red line in the graph; and two white arrows pointing to the top and bottom meters of the HIGH band.

This mono effect provides separate limiters for the low, mid, and high frequencies. You can control the dynamics for each range to adjust the relative levels of the low, mid, and high ranges, with very different results from EQ.

Threshold Offsets

The three bands share common settings for ratio, attack and release times, and output gain adjust. The difference is in the threshold settings. In addition to the overall **Threshold** parameter, each band has a threshold **Offset**, which makes the band more or less sensitive to the input signal.

For example, if you do not want to apply limiting to the high range, reduce the **High Offset** so that it is lower than the **Threshold**. This means that the high range limiter will not respond, and so the high band will pass through unaffected.

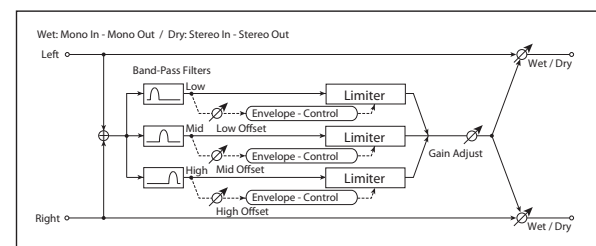

LIMITER

Ratio [1.0:1...50.0:1, Inf:1]

Sets the signal compression ratio. For more information, see “Ratio” on page 765.

Threshold [dB] [-40...0]

Sets the overall level above which the limiter is applied. Each band's Offset parameter then works as an offset for this parameter.

For more information, see "Threshold [dB]" on page 765.

Attack [1...100]

Sets the attack time. For more information, see "Attack [msec]" on page 766.

Release [1...100]

Sets the release time. For more information, see "Release [msec]" on page 766.

Gain Adjust [dB] D^{mod} [-Inf, -38...+24]

Sets the output gain. For more information, see "Gain Adjust [dB]" on page 766.

Source [Off...Tempo]

Selects the modulation source for the output gain.

Amount [-63...+63]

Sets the modulation amount of the output gain.

LOW

Offset [dB] [-40...0]

This adjusts the **Threshold** level for the low range.

MID

Offset [dB] [-40...0]

This adjusts the **Threshold** level for the mid range.

HIGH

Offset [dB] [-40...0]

This adjusts the **Threshold** level for the high range.

OUTPUT

This is the standard effects output section, with modulatable control over wet/dry balance. For more information, see "OUTPUT" on page 764.

007: Stereo Multiband Limiter

This is a true-stereo multiband limiter. For more information, see the mono version, "006: Multiband Limiter," above.

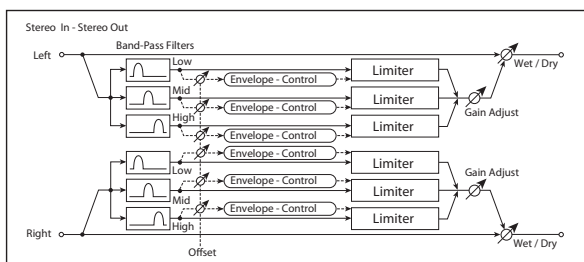

LIMITER

Ratio [1.0:1...50.0:1, Inf:1]

Sets the signal compression ratio. For more information, see "Ratio" on page 765.

Threshold [dB] [-40...0]

Sets the level above which the compressor is applied. For more information, see "Threshold [dB]" on page 765.

Attack [1...100]

Sets the attack time. For more information, see "Attack [msec]" on page 766.

Release [1...100]

Sets the release time. p.766.

Gain Adjust [dB] D^{mod} [-Inf, -38...+24]

Sets the output gain. p.766.

Source [Off...Tempo]

Selects the modulation source for the output gain.

Amount [-63...+63]

Sets the modulation amount of the output gain.

LOW

Offset [dB] [-40...0]

This adjusts the **Threshold** level for the low range. For more information, see "Threshold Offsets" on page 771.

MID

Offset [dB] [-40...0]

This adjusts the **Threshold** level for the mid range.

HIGH

Offset [dB] [-40...0]

This adjusts the **Threshold** level for the high range.

OUTPUT

This is the standard effects output section, with modulatable control over wet/dry balance. For more information, see "OUTPUT" on page 764.

008: Stereo Mastering Limiter

This stereo limiter is optimized for mastering full mixes. It uses a short look-ahead delay (1.3 ms) for zero-overshoot performance, and automatically optimizes the output level to a specified maximum.

For a description of the on-screen graphics, see “005: Stereo Limiter” on page 770.

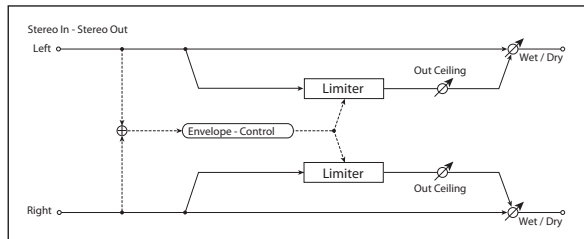

LIMITER

Threshold [dB] **[-30.0...0.0]**

This affects both the limiting threshold and the output gain.

Signals above the **Threshold** will be limited; signals below this level will not be limited, but will still benefit from any increase in output gain (see below).

The output gain is automatically increased by the difference between the **Threshold** and the **Out Ceiling**. For instance, if the **Threshold** is -9.0dB and the **Out Ceiling** is -3.0dB, gain will be increased by 6dB.

Out Ceiling [dB] **[-30.0...0.0]**

This controls the maximum output level. In general, it's best to set this slightly below 0.0, in order to accommodate the less-than-optimal output stages which are sometimes found in consumer audio devices.

An aggressive setting would be -0.3dB; a conservative setting, to avoid clipping on some older CD players, would be -3dB.

Release [msec] **[0.65...1000.0]**

This controls how long it takes the limiter to allow the gain to rise again after the signal is no longer above the threshold. Generally, settings between 1.0 and 5.0 milliseconds will be most effective. For more information, see “Release [msec]” on page 766.

OUTPUT

Wet/Dry **[Dry, 1:99...99:1, Wet]**

Sets the balance between the effect and the dry input.

Important: The look-ahead delay will cause phasing effects if this is set to any in-between values (1:99...99:1). Only completely **Wet** or **Dry** will sound correct.

Source **[Off...Tempo]**

Selects a modulation source for Wet/Dry.

Amount **[+/-100]**

Sets the modulation amount for Wet/Dry.

Using the Stereo Mastering Limiter

Careful compression and limiting are great mastering tools. Here are some simple instructions which should produce good results with most material:

1. **Go to the TFX/MFX page.**
2. **For TFX2, select 008: Stereo Mastering Limiter**
The limiter should be the last effect before the output.
3. **Set the Out Ceiling to a value between -0.3dB and -3dB.**
4. **Leave the Release at the default setting.**
5. **Make sure that Wet/Dry is set to Wet, with no modulation.**
6. **Go to the loudest part of the song.**
7. **While playing the song, adjust the Threshold, and watch the gain reduction meter. Set the Threshold so that the gain reduction meter rarely if ever shows more than 6dB of limiting.**

You could also use a compressor in TFX1, before the limiter, such as 002: Stereo Compressor or 004: St. Multiband Compressor.

Above all, remember to be gentle; the more you increase the volume, the more likely you are to add distortion.

009: Stereo Gate

On-screen graphic, 009 Stereo Gate

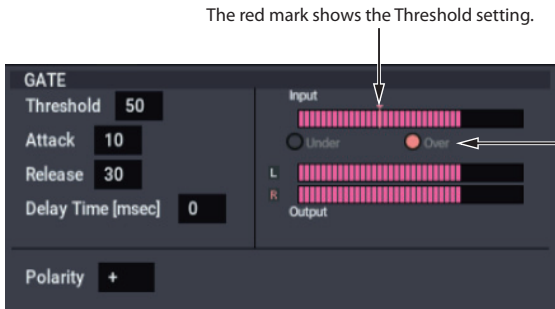

The red mark shows the Threshold setting.

These lights show the relation of the control input to the Threshold, in real-time. Under (green) means the input is below the Threshold, and Over (red) means that it is above the Threshold. Going above the Threshold may make the gate open or close, depending on the Polarity setting.

This effect mutes the input signal when it falls below a specified level. You can also invert the on/off status of the gate, or use note-on/off messages to turn the gate on/off directly.

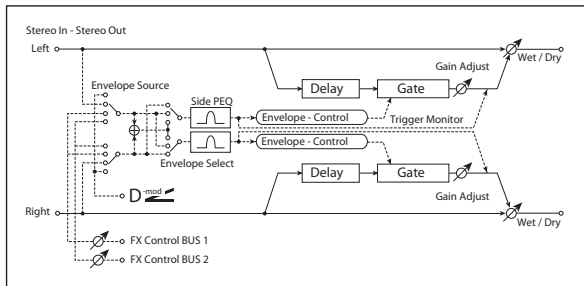

ENVELOPE

Source [Dmod, Input, FX Control 1, FX Control 2]

Selects the source to control the gate: Dmod control, or use the input signal or FX Control Bus 1 or 2 as a trigger. See "Source" on page 764.

Dmod Control [Off...Tempo]

Selects the source that will control the gate when Envelope Source = Dmod.

Select [L/R Mix, L Only, R Only]

Selects the control signal: left and right linked, left only, or right only. See "Select" on page 765.

Fx Control Trim [0...100]

This adjusts the level of the FX Control Bus inputs.

Side Chain Monitor [Check-box]

Switches between monitoring the effect output and the trigger signal. For more information, see "Side Chain Monitor" on page 770.

SIDE CHAIN EQ

This band of fully parametric EQ applies only to the control signal, and not to the main audio path. Use it to alter the response of the limiter so that it reacts (or does not react) only to specific frequencies. Its parameters are identical to those in the Stereo Limiter; for more information, see "SIDE CHAIN EQ" on page 770.

GATE

Threshold [0...100]

Sets the level at which gating is applied.

Note that this does not apply when the ENVELOPE Source is set to **Dmod**.

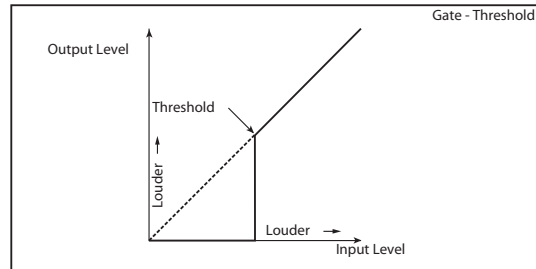

Attack [1...100]

Sets the attack time.

Release [1...100]

Sets the release time.

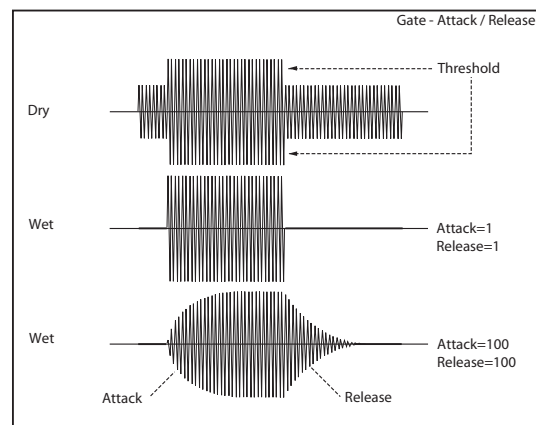

Delay Time [msec] [0...100]

This sets the delay time for the input to the gate. When using shorter Attack Time settings, you can lengthen the Delay Time so that the sound is input after the gate opens.

Polarity [+ , -]

This controls the way that the gate opens and closes in response to the input signal.

+: This is the default setting, for normal gate behavior. The gate will open when the input is above the Threshold, and close when the input falls below it.

–: This reverses the normal operation. The gate will *close* when the input is above the Threshold, and *open* when the input falls below it.

With –, the direction in which the modulation source opens or closes the gate is reversed as well.

OUTPUT

This is the standard effects output section, with modulatable control over wet/dry balance. For more information, see “OUTPUT” on page 764.

010: Stereo Noise Reduction

This effect minimizes obtrusive noise by reducing the volume when the signal is at a low level. You can use this if a guitar or mic signal from the audio input contains noise.

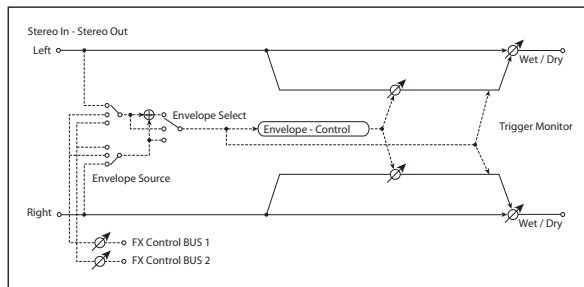

On-screen graphic, 010 Stereo Noise Reduction

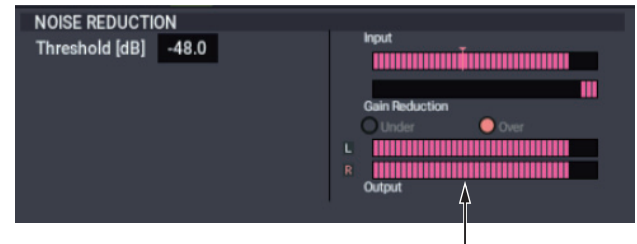

This is a realtime indication of the control input signal level (Input), the gain reduction produced by the control input signal (Gain Reduce), and the output signal level (Output). Noise Reduction reduces the noise level below the Threshold.

ENVELOPE

Envelope Source [Input, FX Control 1, FX Control 2]

Selects the trigger source to use: the input signal, FX Control Bus 1, or FX Control Bus 2. p.764.

Envelope Select [L/R Mix, Left, Right]

Selects whether the compressor is linked between left/right, controlled only by the left signal, only by the right signal, or independently for left and right. p.765.

Fx Control Trim [0...100]

This adjusts the level of the FX Control Bus inputs.

NOISE REDUCTION

Trigger Monitor [Check-box]

Switches between monitoring the effect output and the trigger signal. p.770.

Threshold [dB] [-72.0...-22.0]

Sets the noise level

OUTPUT

This is the standard effects output section, with modulatable control over wet/dry balance. For more information, see “OUTPUT” on page 764.

EQ and Filters

011: Stereo Parametric 4EQ

On-screen graphic, 011 Stereo Parametric 4EQ

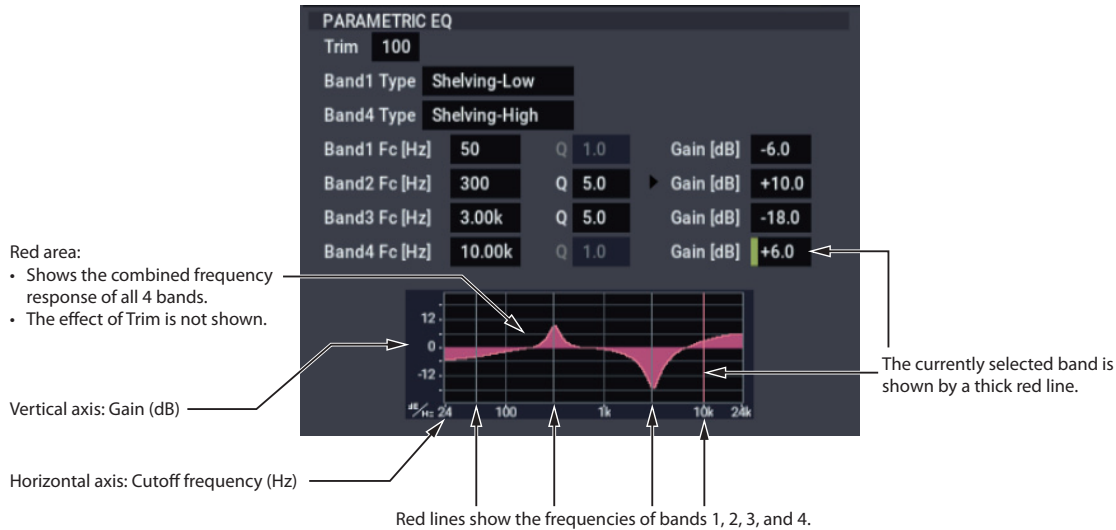

This is a stereo 4-band parametric equalizer. Bands 1 and 4 can be set to either peaking or shelving modes, and you can modulate the gain of Band 2 in real-time.

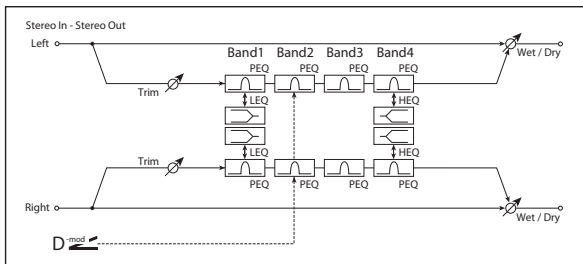

PARAMETRIC EQ

Trim [0...100]

Sets the input level.

Band1 Type [Peaking, Shelving-Low]

Peaking creates a bell shape around a center frequency.

Shelving creates a slope up to a “shelf,” which then extends all the way to the bottom or top of the frequency range.

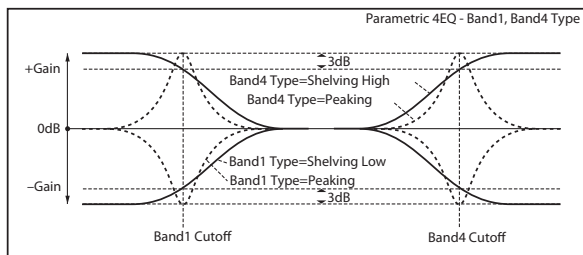

Band4 Type [Peaking, Shelving-High]

Selects the EQ type for Band 4. See “Band1 Type,” above.

Band1 Fc [Hz] [20...1.00k]

Sets the center frequency of Band 1.

Q [0.5...10.0]

Sets the bandwidth of Band 1. The higher the value, the narrower the band becomes.

Gain [dB] [-18.0...+18.0]

Sets the gain of Band 1.

Band2 Fc [Hz] [50...10.00k]

Sets the center frequency of Band 2.

Q [0.5...10.0]

Sets the bandwidth of Band 2.

Gain [dB] $D_{mod} \leq$ [-18.0...+18.0]

Sets the gain of Band 2.

Band3 Fc [Hz] [300...10.00k]

Sets the center frequency of Band 3.

Q [0.5...10.0]

Sets the bandwidth of Band 3.

Gain [dB] [-18.0...+18.0]

Sets the gain of Band 3.

Band4 Fc [Hz] [500...20.00k]

Sets the center frequency of Band 4.

Q [0.5...10.0]

Sets the bandwidth of Band 4.

Gain [dB] [-18.0...+18.0]

Sets the gain of Band 4.

GAIN MOD

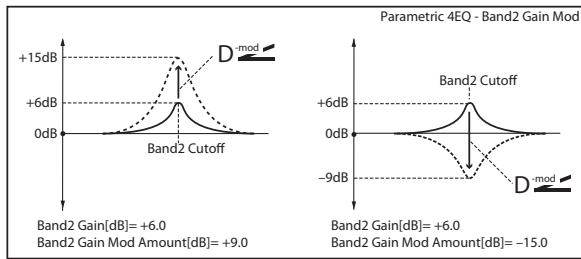

Band2 Source

[Off...Tempo]

Selects the modulation source for the Band 2 gain.

Amount [dB]

[-18.0...+18.0]

Sets the modulation amount for the Band 2 gain.

OUTPUT

This is the standard effects output section, with modulatable control over wet/dry balance. For more information, see "OUTPUT" on page 764.

012: Stereo Graphic 7EQ

On-screen graphic, 012: Stereo Graphic 7EQ

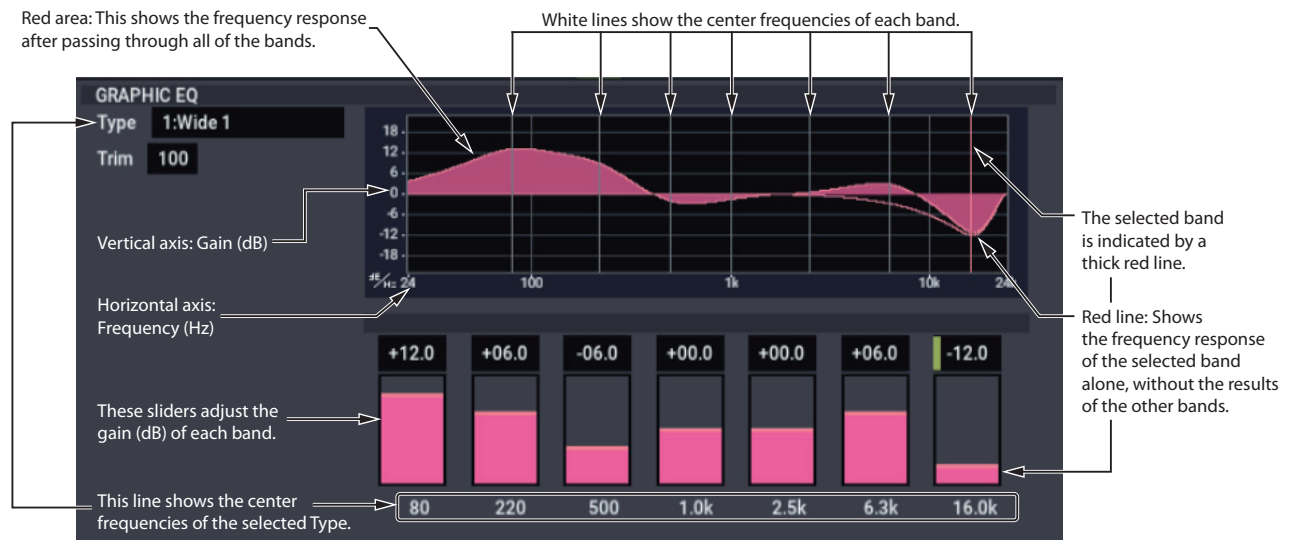

This is a stereo 7-band graphic equalizer. The bar graph of the gain setting for each band gives you a clear, visual idea of frequency responses. You can select a center frequency setting for each band from twelve types, according to the sound.

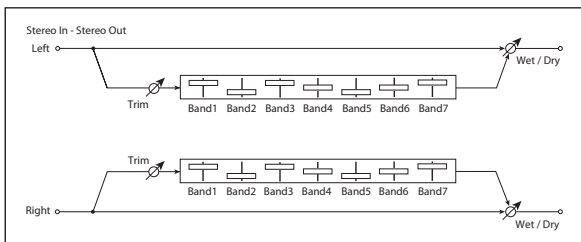

GRAPHIC EQ

Type

[1:Wide 1, 2:Wide 2, 3:Wide 3, 4:Half Wide 1, 5:Half Wide 2, 6:Half Wide 3, 7:Low, 8:Wide Low, 9:Mid, 10:Wide Mid, 11:High, 12:Wide High]

This parameter selects a combination of center frequencies for each band. Each center frequency is shown on the bottom of the Gain slider.

You can configure a 21-Band Graphic EQ ranging from 80Hz to 18kHz if you route three Graphic 7Band EQ effects in series, with a setting of 7:Low, 9:Mid, and 11:High for each EQ.

Trim

[0...100]

Sets the input level

(Band1...8 Gain [dB])

[-18.0...+18.0]

These controls set the gain for each of the eight bands.

OUTPUT

This is the standard effects output section, with modulatable control over wet/dry balance. For more information, see "OUTPUT" on page 764.

013: Stereo Master 3EQ

This is a stereo three-band equalizer, with sweepable low and high shelving and a fully parametric mid-band. The low and high gains can be controlled in real-time. You can use this as a TFX to make final adjustments to the sound.

For a description of the on-screen EQ graphic, see “011: Stereo Parametric 4EQ” on page 776.

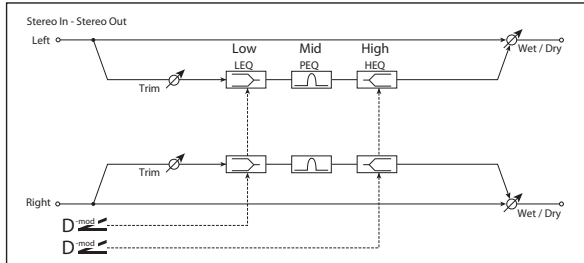

OUTPUT

This is the standard effects output section, with modulatable control over wet/dry balance. For more information, see “OUTPUT” on page 764.

PARAMETRIC EQ

Trim [0...100]

Sets the input level.

Low Fc [Hz] [0...980]

Sets the cutoff frequency of the Low EQ (shelving type).

Gain [dB] D_{mod} [-18.0...+18.0]

Sets the gain of the Low EQ.

Mid Cutoff [Hz] [100...10.00k]

Sets the cutoff frequency of the Mid EQ (peaking type).

Q [0.5...10.0]

Sets the bandwidth of the Mid EQ

Gain [dB] [-18.0...+18.0]

Sets the gain of the Mid EQ.

High Cutoff [Hz] [500...20.00k]

Sets the cutoff frequency of the High EQ (shelving type).

Gain [dB] D_{mod} [-18.0...+18.0]

Sets the gain of the High EQ.

GAIN MOD

Low Source [Off...Tempo]

Selects the source that will modulate the Low Gain.

Amount [dB] [-36.5...+36.0]

Sets the amount by which the Low Gain will be modulated.

High Source [Off...Tempo]

Selects the source that will modulate the High Gain.

Amount [dB] [-36.5...+36.0]

Sets the amount by which the High Gain will be modulated.

014: Stereo Exciter/Enhancer

This effect is a combination of the Exciter, which adds a punch to the sound and the Enhancer, which adds spread and presence.

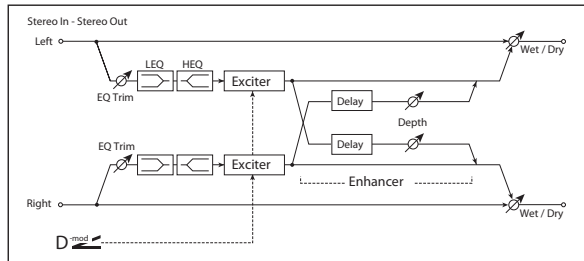

Pre EQ

Trim [0...100]

Sets the 2-band EQ input level.

LEQ Fc [Low, Mid-Low]

Selects the cutoff frequency (low or mid-low) of the low-range equalizer.

LEQ Gain [dB] [-15.0...+15.0]

Sets the gain of the Low EQ.

HEQ Fc [High, Mid-High]

Selects the cutoff frequency (high or mid-high) of the high-range equalizer.

HEQ Gain [dB] [-15.0...+15.0]

Sets the gain of the High EQ.

EXCITER

Emphasis Frequency D_{mod} [0...70]

This parameter sets the frequency to be emphasized. Higher values will emphasize lower frequencies.

Source [Off...Tempo]

Selects the modulation source for the Emphasis Frequency.

Amount [-70...+70]

Sets the amount of modulation of the frequency to be emphasized

Blend D_{mod} [+/-100]

This parameter sets the depth (intensity) of the Exciter effect. Positive values give a frequency pattern (to be emphasized) different from negative values.

Source [Off...Tempo]

Selects the modulation source for the Exciter intensity.

Amount [+/-100]

Sets the modulation amount for the Exciter intensity.

ENHANCER

L Delay Time [msec] [0.0...50.0]

The L and R Delay Time parameters set the delay times for the Enhancer's left and right channels. Specifying slightly different delay times for the left and right channels will add a stereo image, depth, and width to the sound.

R Delay Time [msec] [0.0...50.0]

Sets the delay time for the Enhancer's right channel. For more information, see "L Delay Time [msec]," above.

Depth D_{mod} [0...100]

Sets the determines to what degree the Enhancer effect is applied.

Source [Off...Tempo]

Selects the modulation source of the Enhancer width.

Amount [+/-100]

Sets the modulation amount of the Enhancer width.

OUTPUT

This is the standard effects output section, with modulatable control over wet/dry balance. For more information, see "OUTPUT" on page 764.

015: Stereo Isolator

This is a stereo effect that separates the input signal into low, mid, and high-frequency bands, and controls the volume of each band independently. For example you can separately boost or cut the kick, snare, and hi-hat sounds from a drum signal in realtime.

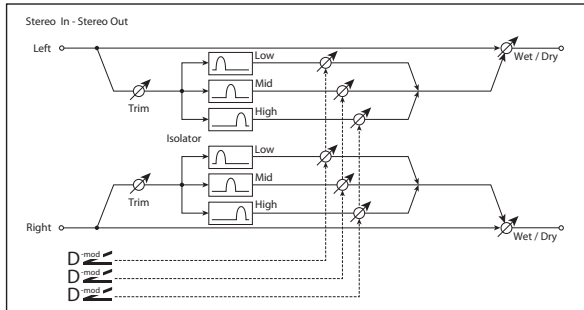

XOVER FILTER

For a description of the on-screen Crossover Filter graphic, see “004: St.Multiband Compressor” on page 768.

Trim [0...100]

Sets the input level.

Frequency Low-Mid [Hz] [100...500]

Sets the frequency at which the low and mid bands are divided.

Frequency Mid-High [Hz] [2000...6000]

Sets the frequency at which the mid and high bands are divided.

ISOLATOR

Low Gain [dB] D_{mod} [-Inf, -59...+12]

Sets the low-frequency gain.

Source [Off...Tempo]

Selects the source that will modulate low-frequency gain.

Amount [-72...+72]

Sets the amount by which the low-frequency gain will be modulated.

Mid Gain [dB] D_{mod} [-Inf, -59...+12]

Sets the mid-frequency gain.

Source [Off...Tempo]

Selects the modulation source for mid-frequency gain.

Amount [-72...+72]

Sets the amount by which the mid-frequency gain will be modulated.

High Gain [dB] D_{mod} [-Inf, -59...+12]

Sets the high-frequency gain.

Source [Off...Tempo]

Selects the modulation source for high-frequency gain.

Amount [-72...+72]

Sets the amount by which the high-frequency gain will be modulated.

OUTPUT

This is the standard effects output section, with modulatable control over wet/dry balance. For more information, see “OUTPUT” on page 764.

016: Stereo Wah/Auto Wah

This stereo wah effect allows you to create sounds from vintage wah pedal simulation to auto-wah simulation, and much broader range settings.

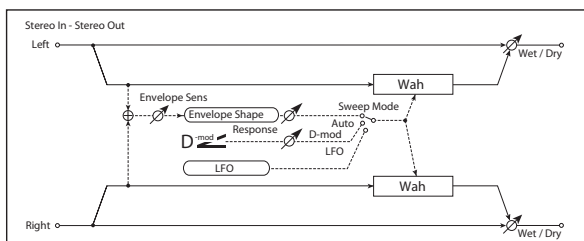

CONTROL

Sweep Mode [Auto, Dmod, LFO]

This parameter selects how the wah will be controlled.

Auto makes the sweeps follow the input signal’s volume envelope. Auto-wah is frequently used for funk guitar parts and clav sounds.

Dmod lets you control the filter directly via a modulation source, just like a wah pedal.

LFO uses an LFO to create cyclic sweeps.

Source D_{mod} [Off...Tempo]

Selects the modulation source for the wah when **Sweep Mode** is set to **Dmod**.

Response [0...100]

Sets the response speed when **Sweep Mode** is set to **Auto** or **Dmod**.

Envelope Sens [0...100]

This parameter sets the sensitivity of auto-wah. Increase the value if the input signal is too low to sweep. Reduce the value if the input signal is so high that the filter is stopped temporarily.

Envelope Shape [+/-100]

This parameter determines the sweep curve for the auto-wah.

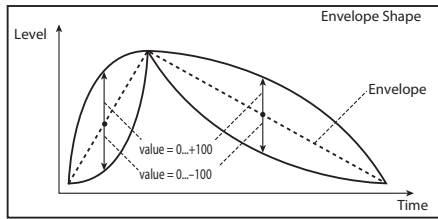

LFO

Frequency

Frequency [Hz] [0.02...20.00]

This sets the LFO speed, in Hz. It applies only when **MIDI/Tempo Sync**, below, is **Off**.

Source [Off...Tempo]

This selects a modulation source for the **Frequency**.

Amount [-20.00...+20.00]

This sets the **Frequency** modulation amount, in Hz.

MIDI/Tempo Sync

MIDI/Tempo Sync [Check-box]

On (checked): When **MIDI/Tempo Sync** is **On**, the LFO will synchronize to tempo as set by **BPM**, below. The LFO speed will be controlled by the **Base Note** and **Times** parameters, below. All settings for **Frequency** and **Frequency Source** and **Amount** will be ignored.

Off (unchecked): When **MIDI/Tempo Sync** is **Off**, the **Frequency** settings will determine the speed of the LFO, and the **BPM**, **Base Note**, and **Times** settings will have no effect.

BPM [MIDI, 40.00...300.00]

MIDI syncs to the system tempo. **40-240** sets the tempo manually for this individual effect.

Base Note [...]

This sets the basic speed of the LFO, relative to the **BPM** setting. The values range from a 32nd note to a whole note, including triplets.

Times [x1...x32]

This multiplies the length of the **Base Note**. For instance, if the **Base Note** is set to a sixteenth note, and **Times** is set to 3, the LFO will cycle over a dotted eighth note.

LFO Type

Type [Individual, Common1, Common2]

Individual: the LFO uses the **Frequency** and **MIDI/Tempo Sync** parameters, above.

Common 1 or 2: the LFO uses the frequency or tempo sync of the selected Common LFO, so that you can synchronize multiple LFO-based effects together.

For more information, see “Common FX LFOs” on page 735.

Common LFO Phase Offset [degrees] [+/-180]

This specifies the phase difference relative to the selected Common FX LFO. It applies only when **Type** is set to **Common 1** or **Common 2**.

WAH

Frequency Bottom [0...100]

This sets the wah frequency when the modulation signal (selected by **Sweep Mode**) is at its minimum level.

To reverse the sweep direction, you can set this to be higher than the **Frequency Top**, below.

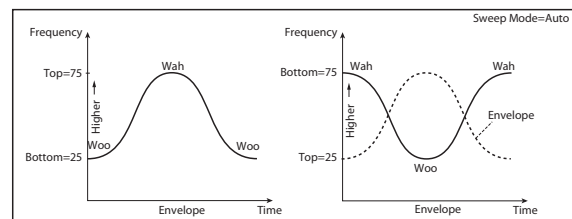
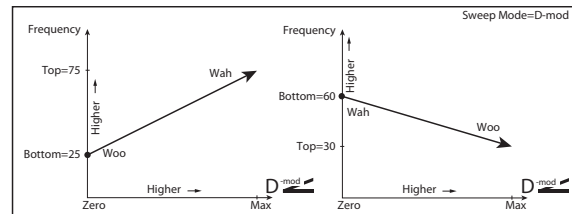

Frequency Top [0...100]

This sets the wah frequency when the modulation signal (selected by **Sweep Mode**) is at its maximum level.

Resonance [0...100]

Sets the resonance amount.

Low Pass Filter [Check-box]

Switches the wah low pass filter on and off.

Output Level [0...100]

Sets the output level of the effect sound.

Source [Off...Tempo]

Selects the modulation source that will control the effect output level.

Amount [+/-100]

Sets the modulation amount of the effect output level.

OUTPUT

This is the standard effects output section, with modulatable control over wet/dry balance. For more information, see “OUTPUT” on page 764.

017: St. Vintage/Custom Wah

This effect models the tonal character of a vintage wah pedal. You can customize the tone and range settings.

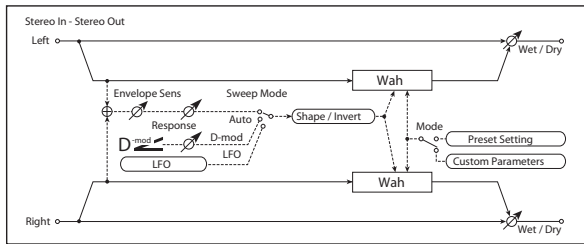

CONTROL

Sweep Mode [Auto, Dmod, LFO]

Selects the control from auto-wah, modulation source, and LFO. For more information, see “Sweep Mode” on page 780.

Source [Off...Tempo]

Selects the modulation source for the wah when **Sweep Mode** is set to **Dmod**.

Manual [0...100]

Sets the center frequency when **Sweep Mode** is set to **Dmod** and **Source** is set to **Off**.

Response [0...100]

Sets the speed of response when **Sweep Mode** is set to **Auto** or **Dmod**.

Envelope Sens [0...100]

Sets the auto-wah sensitivity.

LFO

Frequency [Hz] [0.02...20.00]

This sets the LFO speed, in Hz. It applies only when **MIDI/Tempo Sync**, below, is **Off**.

Source [Off...Tempo]

This selects a modulation source for the **Frequency**.

Amount [-20.00...+20.00]

This sets the **Frequency** modulation amount, in Hz.

MIDI/Tempo Sync [Check-box]

BPM [MIDI, 40.00...300.00]

Base Note []

Times [x1...x32]

When **MIDI/Tempo Sync** is **On**, the LFO speed is set by **BPM**, **Base Note**, and **Times**, instead of **Frequency**. For more information, see “MIDI/Tempo Sync” on page 781.

Type [Individual, Common1, Common2]

This controls whether the effect uses its individual LFO, or one of the Common FX LFOs. For more information, see “LFO Type” on page 781.

Common LFO Phase Offset [degrees] [+/-180]

When **Type** is set to **Common FX LFO 1** or **2**, this lets you offset the phase from the master LFO.

WAH

Mode [Preset, Custom]

Selects either preset or custom settings.

Frequency Bottom [0...100]

Sets the lower limit of the wah center frequency when **Mode** is set to **Custom**. p.781.

Frequency Top [0...100]

Sets the upper limit of the wah center frequency when **Mode** is set to **Custom**. p.781.

Resonance Bottom [0...100]

Sets the lower limit of resonance amount when **Mode** is set to **Custom**.

Resonance Top [0...100]

Sets the upper limit of resonance amount when **Mode** is set to **Custom**.

Shape [+/-100]

This parameter specifies the sweep curve of the wah. It applies to all control via auto-wah, Dmod, and LFO, and lets you adjust subtle nuances of the wah effect.

Invert [Check-box]

Inverts the polarity of the sweep.

Output Level [0...100]

Sets the output level of the effect sound.

Source [Off...Tempo]

Selects the modulation source that will control the effect output level.

Amount [+/-100]

Sets the modulation amount of the effect output level.

OUTPUT

This is the standard effects output section, with modulatable control over wet/dry balance. For more information, see “OUTPUT” on page 764.

018: Stereo Random Filter

This stereo band pass filter is modulated by an LFO, using either a step-shape waveform and or a sample-and-hold shape. The filter will also self-resonate, for creating special effects.

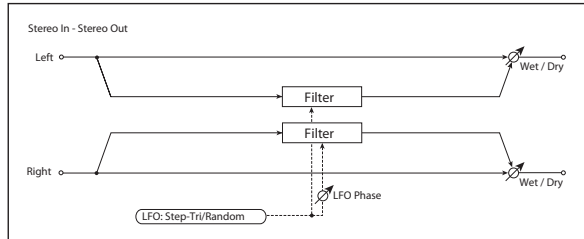

FILTER

Manual [0...100]

Sets the filter's center frequency, before LFO modulation.

Depth D_{mod} [0...100]

The LFO modulates the filter's frequency; this sets the intensity of the LFO modulation.

Source [Off...Tempo]

Selects a source to modulate the LFO Depth.

Amount [+/-100]

Sets the intensity of the Depth modulation.

Resonance [0...100]

Resonance emphasizes the audio around the filter's center frequency.

At 0, there is no emphasis, and frequencies outside the center will simply diminish smoothly.

At medium settings, the resonance will alter the timbre of the filter, making it sound more nasal or extreme.

At very high settings, the resonance can be heard as a separate, whistling pitch. At 100, the filter will self-oscillate (after being fed an initial burst of input).

LFO

Waveform and Phase

Waveform [Step-Tri, Random]

Step-Tri creates a steppy triangle waveform (see the diagram below). The LFO Frequency parameter sets the original triangle waveform speed, and the LFO Step Freq parameter adjusts the width of the steps.

Random produces a sample-and-hold waveform, with the speed controlled by the Step Freq.

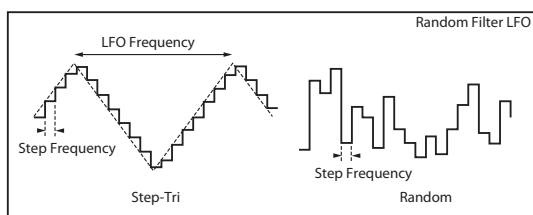

Phase [degrees] [-18...+18]

This sets the LFO phase difference between the left and right, in steps of 10 degrees. Offsetting the left and right phases alters how modulation is applied to the left and right channels, creating a swelling effect.

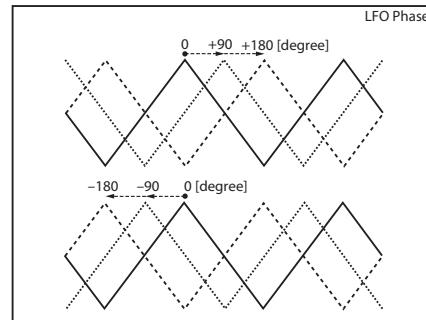

Frequency

These parameters apply when MIDI/Tempo Sync is Off (un-checked).

Frequency [Hz] D_{mod} [0.02...20.00]

This sets the speed of the triangle waveform, in Hz.

Step Frequency [Hz] D_{mod} [0.05...50.00]

This sets the speed of the steps, in Hz.

Source [Off...Tempo]

This selects a modulation source for both the Frequency and the Step Frequency. You can set the modulation amounts individually, below.

Amount [-20.00...+20.00]

Sets the Frequency modulation amount, in Hz.

Step Amount [-50.00...+50.00]

Sets the Step Frequency modulation amount, in Hz.

MIDI/Tempo Sync

MIDI/Tempo Sync [Check-box]

When this is on, the LFO speed is set by BPM, Base Note, and Times, instead of Frequency. For more information, see "MIDI/Tempo Sync" on page 781.

BPM [MIDI, 40.00...300.00]

MIDI syncs to the system tempo. 40-240 sets the tempo manually for this individual effect.

Base Note [♩...]

Times [x1...x32]

These set triangle waveform's base note and multiplier. For more information, see "MIDI/Tempo Sync" on page 781.

Step Note D_{mod} [♩...]

Times [x1...x32]

These set the step's base note and multiplier. For more information, see "MIDI/Tempo Sync" on page 781.

Step LFO type

Type (Step) [Individual, Common1, Common2]

This controls the LFO source for the steps. It does not affect the triangle LFO.

Individual: the steps use the Frequency and MIDI/Tempo Sync parameters, above.

Common 1 or 2: the steps use the frequency or tempo sync of the selected Common LFO, so that you can synchronize multiple LFO-based effects together.

Common LFO Phase Offset [degrees] [+/-180]

Sets the phase offset when Type = Common 1 or Common 2. p.781.

019: Multi Mode Filter

This multi-mode filter includes low pass, high pass, band pass, and band reject modes. You can modulate the cutoff frequency and resonance from either an LFO or dynamic modulation.

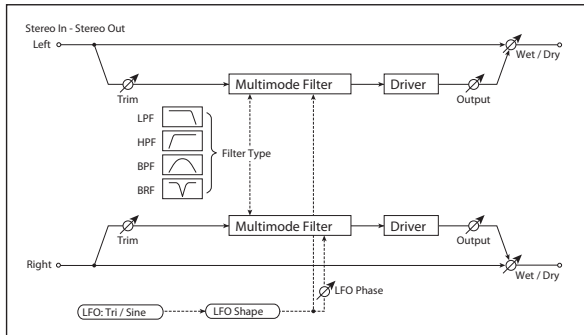

MULTIMODE FILTER

Trim [0...100]

Sets the input level.

Type [LPF, HPF, BPF, BRF]

Selects the type of filter. For more information, see “Filter Type” on page 63.

Cutoff Frequency D_{mod} [0...100]

Sets the cutoff frequency (center frequency).

Source [Off...Tempo]

Selects the modulation source of the cutoff.

Amount [+/-100]

Sets the modulation amount of the cutoff.

Depth [0...100]

Sets the depth to which the LFO will modulate the cutoff frequency.

Resonance D_{mod} [0...100]

Sets the resonance amount.

Source [Off...Tempo]

Selects the source that will modulate the amount of resonance.

OUTPUT

Wet/Dry D_{mod} [-Wet, -99:1...-1:99, Dry, 1:99...99:1, Wet]

This sets the balance between the effect and the dry input. From **-Wet** to **-1:99**, the effect sound’s phase will be reversed.

Source [Off...Tempo]

This selects a modulation source for **Wet/Dry**.

Amount [+/-100]

This sets the modulation amount for **Wet/Dry**.

Amount [+/-100]

Sets the amount by which the resonance will be modulated.

DRIVER

Bypass [Check-box]

Switches distortion on/off within the filter.

Gain [0...100]

Sets the distortion amount.

Low Boost [0...100]

Sets the amount of low-range boost.

Output [0...100]

Sets the output level.

LFO

Waveform [Triangle, Sine]

Selects the LFO Waveform.

Shape [+/-100]

This changes the curvature of the LFO Waveform, which emphasizes or de-emphasizes the peaks, as shown below.

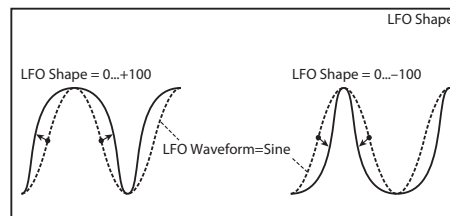

Phase [degrees] [-180...+180]

Sets the LFO phase difference between the left and right. See “Phase [degrees]” on page 783.

Frequency [Hz] D_{mod} [0.02...20.00]

This sets the LFO speed, in Hz. It applies only when **MIDI/Tempo Sync**, below, is **Off**.

Source [Off...Tempo]

This selects a modulation source for the **Frequency**.

Amount [-20.00...+20.00]This sets the **Frequency** modulation amount, in Hz.**MIDI/Tempo Sync**  [Check-box]**BPM** [MIDI, 40.00...300.00]**Base Note** [♪...♭]**Times** [x1...x32]When **MIDI/Tempo Sync** is on, the LFO speed is set by **BPM**, **Base Note**, and **Times**, instead of **Frequency**. For more information, see “MIDI/Tempo Sync” on page 781.**Type** [Individual, Common1, Common2]

This controls whether the effect uses its individual LFO, or one of the Common FX LFOs. For more information, see “LFO Type” on page 781.

Common LFO Phase Offset [degrees] [±180]When **Type** is set to **Common FX LFO 1** or **2**, this lets you offset the phase from the master LFO.

OUTPUT

This is the standard effects output section, with modulatable control over wet/dry balance. For more information, see “OUTPUT” on page 764.

020: Stereo Sub Oscillator

This effect adds very low frequencies to the input signal. It’s useful for creating powerful sub-bass effects, such as deep, rumbling drum sounds. You can also adjust the oscillator frequency to follow incoming MIDI notes, for use as an octaver.

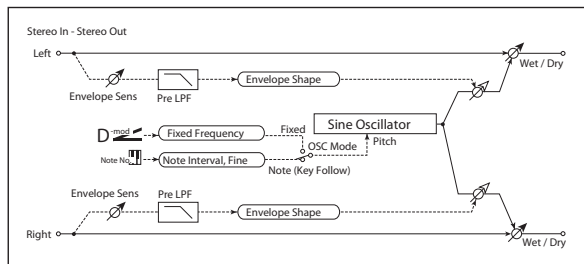

ENVELOPE

Pre LPF [1...100]

This parameter sets the upper limit of the frequency range to which very low harmonics are added. Adjust this parameter if you do not want to add lower harmonics to the higher range.

Sensitivity [0...100]

Sets the sensitivity with which very low harmonics are added.

Shape [±100]

Sets the oscillator’s volume envelope curve.

SUB OSCILLATOR

OSC Mode [Note (Key Follow), Fixed]

This determines whether the oscillator frequency follows the note number, or stays at a fixed value.

Note (Key Follow): The oscillator’s frequency is based on MIDI note number (on the effect’s MIDI channel), allowing you to use it as an octaver. The **Note Interval** parameter, below, sets the pitch offset from the original note, in semitones.**Fixed**: the oscillator uses the manually-set **Fixed Frequency**, below.**Note Interval** [-48...0]This sets a pitch offset from the received MIDI note number, in semitones. It applies only when **OSC Mode** is set to **Note (Key Follow)**.**Note Fine** [±100]This adjusts the frequency in cents (1/100 of a semitone). It applies only when **OSC Mode** is set to **Note (Key Follow)**.**Fixed Frequency [Hz]**  [10.0...80.0]Sets the oscillator frequency when **OSC Mode** is set to **Fixed**.**Source** [Off...Tempo]Selects the modulation source for the oscillator frequency when **OSC Mode** is set to **Fixed**.**Amount** [-80...+80]Sets the oscillator frequency modulation amount when **OSC Mode** is set to **Fixed**.

OUTPUT

This is the standard effects output section, with modulatable control over wet/dry balance. For more information, see “OUTPUT” on page 764.

021: Talking Modulator

This effect adds an unusual character, like a human voice, to the input signal. Modulating the tone via dynamic modulation, you can create an interesting effect that sounds as if the guitar or synthesizer is talking.

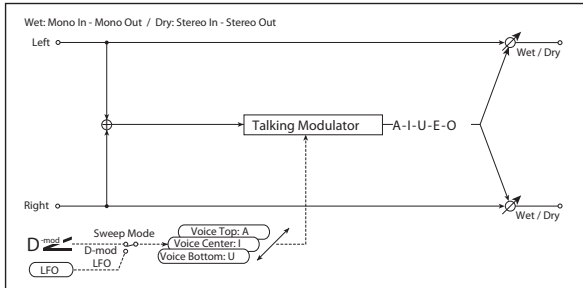

CONTROL

Sweep Mode [Dmod, LFO]

Switches between modulation source control and LFO control.

Source [Off...Tempo]

Selects the modulation source that controls the voice pattern.

Manual Voice Control [Bottom, 1...49, Center, 51...99, Top]

Voice pattern control.

TALKING MODULATOR

The **Voice Top**, **Center**, and **Bottom** parameters assign vowels to the top, center, and bottom positions of the Dmod controller or LFO.

For instance, when **Voice Top** is set to **A**, **Voice Center** is set to **I**, and **Voice Bottom** is set to **U**:

If **Sweep Mode** is set to **Dmod** and JS+Y is selected as the modulation **Source**, moving the joystick upwards will change the sound from “a” to “i,” then “u.”

If **Sweep Mode** is set to **LFO**, the sound will change cyclically from “a” to “i,” “u,” “i,” then “a.”

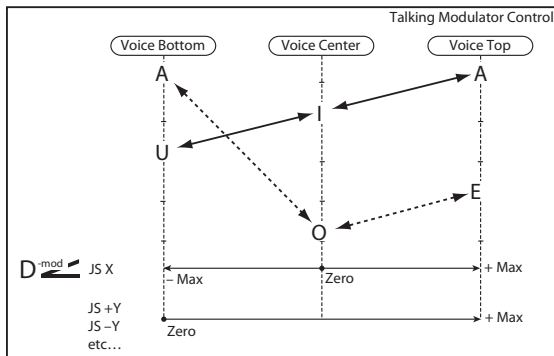

Voice Top [A, I, U, E, O]

Selects a vowel sound at the maximum modulation value.

Voice Center [A, I, U, E, O]

Selects a vowel sound at the center modulation value.

Voice Bottom [A, I, U, E, O]

Selects a vowel sound at the minimum modulation value.

Formant Shift [+/-100]

Sets the frequency to which the effect is applied.

This parameter adjusts the frequency level to which the effect is applied. If you wish to apply the effect to a higher-range sound, set this parameter to a higher value; to apply the effect to a lower-range sound, set this to a lower value.

Resonance [0...100]

Sets the Level of resonance of the voice pattern. This parameter sets the intensity of resonance for the voice pattern. A larger value will add more character to the sound.

LFO

Frequency [Hz] [0.02...20.00]

This sets the LFO speed, in Hz. It applies only when **MIDI/Tempo Sync**, below, is **Off**.

Source [Off...Tempo]

This selects a modulation source for the **Frequency**.

Amount [-20.00...+20.00]

This sets the **Frequency** modulation amount, in Hz.

MIDI/Tempo Sync [Check-box]

BPM [MIDI, 40.00...300.00]

Base Note []

Times [x1...x32]

When **MIDI/Tempo Sync** is on, the LFO speed is set by **BPM**, **Base Note**, and **Times**, instead of **Frequency**. For more information, see “MIDI/Tempo Sync” on page 781.

Type [Individual, Common1, Common2]

This controls whether the effect uses its individual LFO, or one of the Common FX LFOs. For more information, see “LFO Type” on page 781.

Common LFO Phase Offset [degrees] [+/-180]

When **Type** is set to **Common FX LFO 1** or **2**, this lets you offset the phase from the master LFO.

OUTPUT

This is the standard effects output section, with modulatable control over wet/dry balance. For more information, see “OUTPUT” on page 764.

022: Stereo Decimator

This effect creates a rough sound like a cheap sampler by lowering the sampling frequency, reducing the bit depth, and creating aliasing.

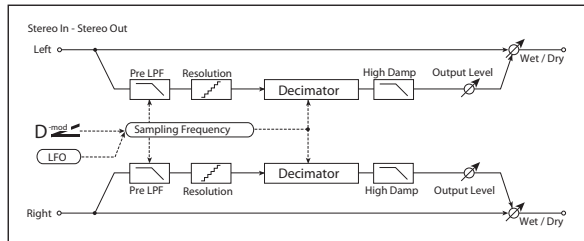

DECIMATOR

Pre LPF [Check-box]

If a sampler (or other digital audio device) tries to record a pitch higher than half the sampling frequency, this generates a particular kind of pitched noise, called aliasing. Reducing the sampling frequency will tend to increase the amount of aliasing.

Set **Pre LPF** to ON to prevent aliasing, or leave it OFF to create aliasing artifacts.

To create a sound similar to a ring modulator, set the **Sampling Freq** to about 3kHz and set **Pre LPF** to OFF.

Sampling Frequency [Hz] D_{mod} [1.00k...48.00k]

Sets the sampling frequency.

Source [Off...Tempo]

Selects the modulation source of the sampling frequency.

Amount [-48.00k...+48.00k]

Sets the modulation amount of the sampling frequency.

Depth D_{mod} [0...100]

Sets the depth of the sampling frequency LFO modulation.

Source [Off...Tempo]

Selects the LFO modulation source of the sampling frequency.

Amount [+/-100]

Sets the LFO modulation amount of the sampling frequency.

High Damp [%] [0...100]

Sets the amount of high-frequency attenuation.

BIT SHAPE

Resolution [bits] [4...24]

Sets the data bit length. With lower settings, the sound may be distorted, and the volume may increase. You can use the **Output Level** parameter, below, to adjust the volume as necessary.

Output Level D_{mod} [0...100]

Sets the output level.

Source [Off...Tempo]

Selects the modulation source for the output level.

Amount [+/-100]

Sets the modulation amount of the output level.

LFO

Frequency [Hz] D_{mod} [0.02...20.00]

This sets the LFO speed, in Hz. It applies only when **MIDI/Tempo Sync**, below, is Off.

Source [Off...Tempo]

This selects a modulation source for the **Frequency**.

Amount [-20.00...+20.00]

This sets the **Frequency** modulation amount, in Hz.

MIDI/Tempo Sync D_{mod} [Check-box]

BPM [MIDI, 40.00...300.00]

Base Note [♪...♩]

Times [x1...x32]

When **MIDI/Tempo Sync** is on, the LFO speed is set by **BPM**, **Base Note**, and **Times**, instead of **Frequency**. For more information, see “MIDI/Tempo Sync” on page 781.

Type [Individual, Common1, Common2]

This controls whether the effect uses its individual LFO, or one of the Common FX LFOs. For more information, see “LFO Type” on page 781.

Common LFO Phase Offset [degrees] [+/-180]

When **Type** is set to **Common FX LFO 1** or **2**, this lets you offset the phase from the master LFO.

OUTPUT

This is the standard effects output section, with modulatable control over wet/dry balance. For more information, see “OUTPUT” on page 764.

023: Stereo Analog Record

This effect simulates the noise caused by scratches and dust on analog records. It also reproduces some of the modulation caused by a warped turntable.

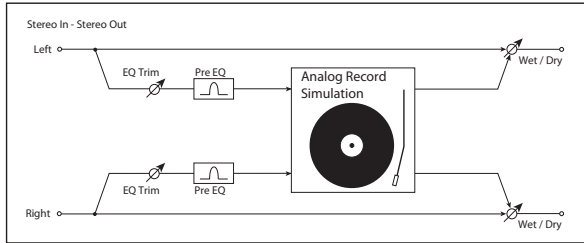

Pre EQ

Trim [0...100]

Sets the EQ input level.

Fc [Hz] [300...10.00k]

Sets the EQ center frequency.

Q [0.5...10.0]

Sets the EQ band width.

Gain [dB] [-18.0...+18.0]

Sets the EQ gain.

ANALOG RECORD

Speed [RPM] [33 1/3, 45, 78]

Sets the rotation speed of the record.

Flutter [0...100]

This parameter enables you to set the depth of the modulation caused by a warped turntable.

NOISE

Density [0...100]

Sets the noise density.

Tone [0...100]

Sets the noise tone.

Level D_{mod} [0...100]

Sets the noise level.

Source [Off...Tempo]

Selects the modulation source for the noise level.

Amount [+/-100]

Sets the modulation amount of the noise level.

CLICK

Level D_{mod} [0...100]

This parameter enables you to set the level of the click noise that occurs once every rotation of the turntable. This simulation reproduces record noise, and the noise generated after the music on a vinyl record finishes.

Source [Off...Tempo]

Selects the modulation source for the click noise level.

Amount [+/-100]

Sets the modulation amount of the click noise level.

OUTPUT

This is the standard effects output section, with modulatable control over wet/dry balance. For more information, see "OUTPUT" on page 764.

024: Stereo Wave Shaper

This is a stereo effect that reshapes the waveform of the input signal, generating numerous overtones that were not present in the original signal.

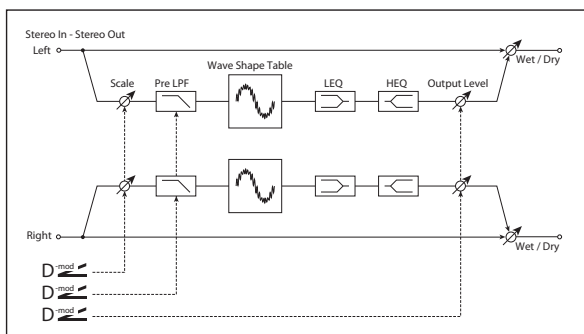

WAVE SHAPER

Wave Shape Table [Sine...Wurly]

The table determines the basic timbre of the effect.

Wave Shape Tables

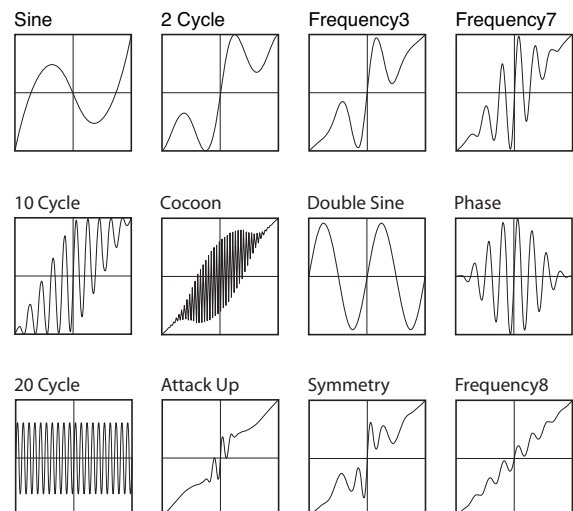

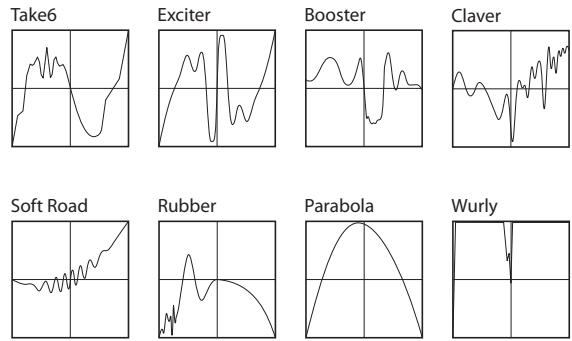
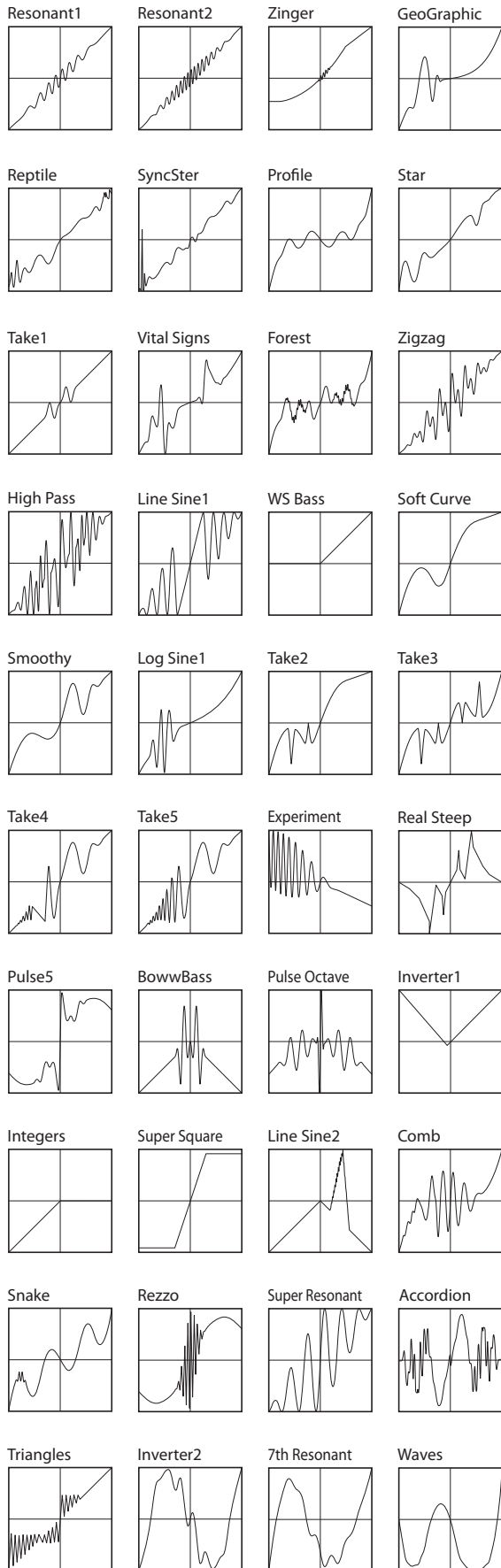

Pre LPF D_{mod} [0...100]

Sets the damping amount in the high range.

Source [Off...Tempo]

Selects the source that will modulate the amount of high range damping.

Amount [+/-100]

Sets the depth by which the amount of high range damping will be modulated.

Scale [dB] D_{mod} [-36...+36]

This sets the input level to the wave shape table. Even for the same waveform, changing the input level will dramatically modify the output waveform and the tone.

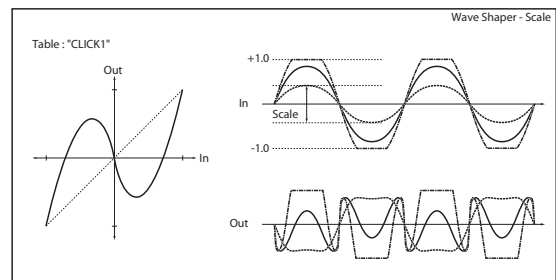

Source [Off...Tempo]

Selects the modulation source for the Scale.

Amount [-72...+72]

Selects the modulation amount for the Scale.

EQ

LEQ Fc [Low, Mid-Low]

Selects the cutoff frequency (low or mid-low) of the low-range equalizer.

LEQ Gain [dB] [-15.0...+15.0]

Sets the gain of the Low EQ.

HEQ Fc [High, Mid-High]

Selects the cutoff frequency (high or mid-high) of the high-range equalizer.

HEQ Gain [dB] [-15.0...+15.0]

Sets the gain of the High EQ.

Output Level D_{mod} [0...100]

Sets the output level.

Source [Off...Tempo]

Selects the modulation source for the **Output Level**.

Amount [+/-100]

Sets the modulation amount for the **Output Level**.

OUTPUT

This is the standard effects output section, with modulatable control over wet/dry balance. For more information, see “OUTPUT” on page 764.

025: Piano Body/Damper

This effect simulates the resonance of the piano sound board caused by the string vibration, and also simulates the resonance of other strings that are not being played when you press the damper pedal. It will create a very realistic sound when applied to acoustic piano sounds.

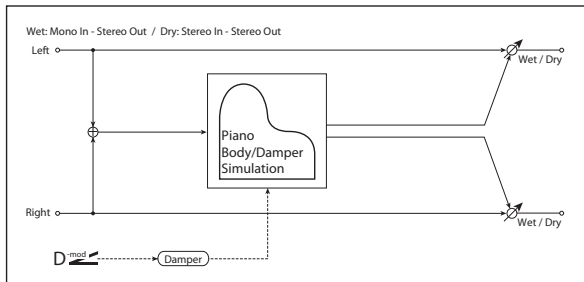

SOUND BOARD

Depth [0...100]

This parameter sets the intensity of the soundboard’s resonance.

DAMPER

Depth  [0...100]

This parameter sets the resonance intensity of the other strings created when the damper pedal is pressed. The **Source** parameter, below, selects the modulation source from which the damper effect is applied. Usually, select Damper (CC# 64).

Source [Off...Tempo]

Selects the modulation source of damper effect.

 The effect is off when a value for the modulation source specified for the **Source** parameter is 63 or smaller, and the effect is on when the value is 64 or higher.

TONE

Tone [1...100]

This controls the brightness of the soundboard resonance.

Mid Shape [0...36]

This controls the mid-range frequencies of the resonance. Higher values **decrease** the amount of mid-range frequencies.

Tune [-50...+50]

This controls the fine-tuning of the resonance. Since this effect simulates the resonance of the strings, the sound varies depending on the pitch. If you have changed tuning using the “Master Tune” (GLOBAL > Basic Setup– Basic page), adjust this parameter value.

OUTPUT

This is the standard effects output section, with modulatable control over wet/dry balance. For more information, see “OUTPUT” on page 764.

026: Vocoder

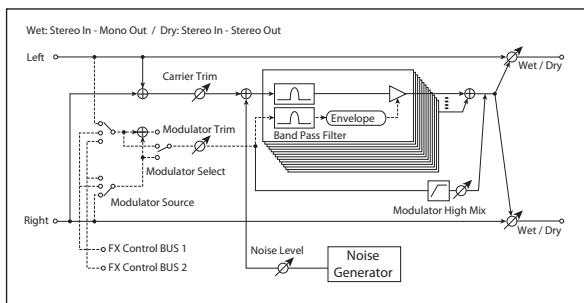

Vocoder overview

Vocoder effects superimpose the timbre of one signal (the modulator) onto that of a second signal (the carrier). The first vocoders were intended mostly for speech effects. For instance, you can produce the classic “talking synthesizer” sound by using a voice as a modulator and a bright synthesizer pad as a carrier.

This is only part of the effect’s potential, however. You can use vocoders to combine practically any two sounds, as long as the frequency ranges overlap sufficiently. Drums make particularly good modulators, for instance.

A vocoder is essentially a combination of a multi-band frequency analyzer and a multi-band dynamic EQ. The modulator signal is divided up into a number of frequency bands, and the levels of each of these bands are measured in real time. A multi-band dynamic EQ is slaved to the analyzer, following the changes in each band of the modulator with similar changes in the EQ of the carrier. This causes the carrier to assume some of the timbre of the modulator.

It’s best for the carrier to contain a wide range of frequencies. If there is little or no material in some of the bands to begin with, the EQ will have nothing to alter, and the vocoder’s effect will be less distinct. If you want to use a particular sound as the carrier, but it doesn’t seem to have a sufficient frequency range, try using the **Noise Level** parameter to mix in some of the vocoder’s built-in noise generator.

For instance, bright synthesizer sounds, distorted guitars, noise, or strings all make good carrier signals.

For more information on using vocoders, see “Vocoder (PROGRAM mode)” on page 736 and “Rhythmic Vocoder (COMBINATION mode)” on page 737.

Using the vocoder with a mic input

To use a voice from a microphone as a modulator:

1. **Connect a mic to Audio Input 1 or 2, and set the Input Select to MIC.**
2. **Go to the GLOBAL > Basic Setup– Analog Setup page.**
3. **For the Audio Input to which you connected the mic, temporarily set Bus Select to L/R.**

This lets you listen to the mic input while adjusting the LEVEL control.

4. **While talking into the mic, use the Analog Input Gain to adjust the level as high as possible without distortion.**

After adjusting the LEVEL, you can change the bus settings for use with the vocoder:

5. **For the Audio Input to which you connected the mic, turn Bus Select Off, and set FX Ctrl Bus Select to 1.**
6. **In the Vocoder effect, set the MODULATOR Source to FX Control Bus 1.**
7. **Route a synth sound into the Vocoder effect.**

With these settings, the sound from the mic will be used as the modulator. While you play, speak into the mic; it will sound as though the instrument is talking.

If the sound is distorted, adjust the **CARRIER Trim** and/or **MODULATOR Trim**.

CARRIER

Note that the left and right inputs are always summed into the Carrier, regardless of the **MODULATOR Select** parameter below. To use a separate signal (such as a mic input) as the Modulator, route it through **FX Control Bus 1** or **2**.

Trim [0...100]

Sets the Carrier input level.

Noise Level D_{mod} [0...100]

This controls the level of the built-in noise generator. You can mix this with the Carrier input, or set the Carrier Trim to 0 and use only the noise, if desired. You can also modulate the **Noise Level** using Dmod, controlled by the **Source** and **Amount** parameters below.

Source [Off...Tempo]

Selects the modulation source for the **Noise Level**.

Amount [+/-100]

Sets the modulation amount for the **Noise Level**.

MODULATOR

Trim [0...100]

This controls the input level of the Modulator.

Source [Input, FX Control 1, FX Control 2]

Selects the signal to use as the Modulator input.

Input uses the input to the Vocoder effect. This is good when you want the input to “vocode” itself.

FX Control 1 and **2** use the signal from the FX Control Buses. For classic vocoding effects, such as a mic input as the modulator and a synth as the carrier, you **must** use one of these buses.

Select [L/R Mix, L Only, R Only]

Selects whether to use the left/right mix, only the left channel, or only the right channel of the Modulator input.

VOCODER

Formant Shift [-2...+2]

This lets you offset the Carrier filters, so that they are either higher or lower than the Modulator filters. This produces effects similar to transposing a sample, and produces significant changes in the overall character.

Response [0...100]

This controls how quickly the vocoder responds to changes in the Modulator. The default of **60** generally works well for most purposes.

Lower values produce slower response times, which can produce interesting sweeping effects. Higher values are useful for percussion, but can cause jittery response with smoother Modulator signals.

Low Gain [dB] [-12...+12]

Sets the low-range output level of the vocoder.

High Gain [dB] [-12...+12]

Sets the high-range output level of the vocoder.

Modulator High Mix [0...100]

This lets you mix a highpass-filtered version of the Modulator directly to the output, bypassing the main vocoder effect. When using a voice as the modulator, this can increase intelligibility.

OUTPUT

This is the standard effects output section, with modulatable control over wet/dry balance. For more information, see “OUTPUT” on page 764.

Overdrive, Amp models, and Mic models

027: OD/Hi-Gain Wah

This versatile effect offers two different-sounding distortion modes (Overdrive and Hi-Gain), a modulatable wah-wah filter, a speaker simulation, and 3-band EQ. It's suitable for guitars, organs, and general sonic mayhem.

For a description of the on-screen EQ graphic, see “011: Stereo Parametric 4EQ” on page 776.

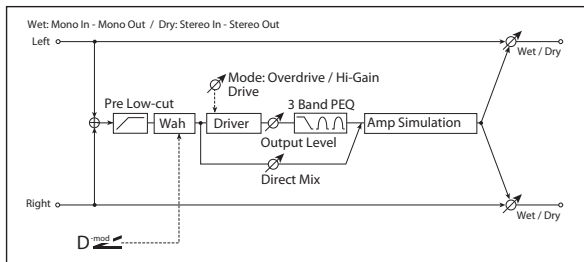

WAH

Wah Switch

Wah Switch [Off, On]

This turns the Wah effect on and off.

Source [Off...Tempo]

Selects the modulation source that switches the Wah on and off.

Mode [Toggle, Moment]

This parameter controls how the modulation source switches the overdrive on and off.

When **Mode** = **Toggle**, the overdrive turns on or off each time you press the pedal or move the joystick. Via MIDI, overdrive turns on or off each time the modulation amount exceeds 64.

When **Mode** = **Moment** (short for Momentary), the overdrive is normally off, and turns on only when you press the pedal or move the joystick. Via MIDI, modulation values above 64 turn it on, and values below 64 turn it off.

Wah Sweep

Sweep Range [-10...+10]

This controls the width of the Wah's sweep, from the minimum to maximum values of the modulation **Source** selected below.

Negative values reverse the sweep's direction, from high to low instead of low to high.

Source [Off...Tempo]

This selects a modulation source to control the Wah.

DRIVE

Pre Low-cut [0...10]

This attenuates low frequencies before the signal enters the distortion. Use this to create a sharper tone.

Drive Mode [Overdrive, Hi-Gain]

This switches between two different distortion timbres: overdrive and hi-gain distortion.

Drive [1...100]

The amount of distortion is determined by the combination of the input level and the **Drive** setting. Higher input levels, and/or higher **Drive** settings, mean more distortion.

Raising the **Drive** setting will also increase the volume; you can compensate for this by lowering the **Output Level** parameter, below.

Direct Mix [0...50]

Sets the amount of the dry sound mixed to the distortion.

Speaker Simulation [Check-box]

Switches the speaker simulation on/off.

Output Level [0...50]

This controls the output volume from the Drive section into the 3-band EQ. You can use this to reduce the volume to compensate for high Drive settings, or to prevent clipping in the EQ.

Source [Off...Tempo]

Selects the modulation source for the output level.

Amount [-50...+50]

Sets the modulation amount for the output level.

EQ

Low Fc [Hz] [20...1.00k]

Sets the center frequency for Low EQ (shelving type).

Gain [dB] [-18...+18]

Sets the gain of the Low EQ.

Mid1 Fc [Hz] [300...10.00k]

Sets the center frequency for Mid EQ 1 (peaking type).

Q [0.5...10.0]

Sets the band width of Mid EQ 1. p.776.

Gain [dB] [-18...+18]

Sets the gain of Mid EQ 1.

Mid2 Fc [Hz] [500...20.00k]

Sets the center frequency for Mid EQ 2 (peaking type).

Q [0.5...10.0]

Sets the band width of Mid EQ 2. See “Q” on page 776.

Gain [dB] [-18...+18]

Sets the gain of Mid EQ 2.

OUTPUT

This is the standard effects output section, with modulatable control over wet/dry balance. For more information, see “OUTPUT” on page 764.

028: OD/HyperGain Wah

This distortion effect has two modes: overdrive and hyper-gain that produces a strong distortion. A higher high-gain setting is required for this effect relative to a normal-size effect.

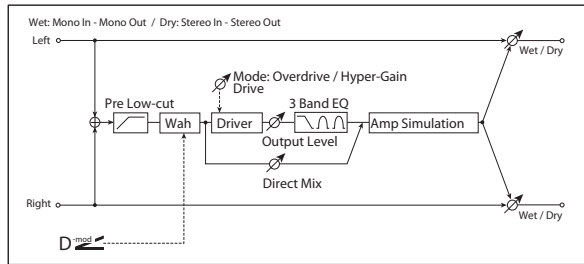

WAH

Wah Switch [Off, On]

Source [Off...Tempo]

Mode [Toggle, Moment]

These parameters let you turn the Wah on and off from either the LCD or a controller, and determine how the controller works. For more information, see “Wah Switch” on page 792.

Sweep Range [-10...+10]

Source [Off...Tempo]

These parameters set the modulation source and amount for the Wah. For more information, see “Wah Sweep” on page 792.

DRIVE

Pre Low-cut [0...10]

This attenuates low frequencies before the signal enters the distortion. Use this to create a sharper tone.

Drive Mode [Overdrive, Hyper-Gain]

Switches between overdrive and hyper-gain mode.

Drive [1...120]

Sets the degree of distortion. For more information, see “DRIVE” on page 792.

Direct Mix [0...50]

Amount of the dry sound mixed to the distortion.

Speaker Simulation [Check-box]

Speaker simulation on/off.

Output Level [0...50]

Sets the output level. For more information, see “DRIVE” on page 793.

Source [Off...Tempo]

Selects the modulation source for the output level.

Amount [-50...+50]

Sets the modulation amount of the output level.

EQ

Low Fc [Hz] [20...1.00k]

Sets the center frequency for Low EQ (shelving type).

Gain [dB] [-18...+18]

Sets the gain of the Low EQ.

Mid1 Fc [Hz] [300...10.00k]

Sets the center frequency for Mid/High EQ 1 (peaking type).

Q [0.5...10.0]

Sets the band width of Mid/High EQ 1. See “Q” on page 776.

Gain [dB] [-18...+18]

Sets the gain of Mid/High EQ 1.

Mid2 Fc [Hz] [500...20.00k]

Sets the center frequency for Mid/High EQ 2 (peaking type).

Q [0.5...10.0]

Sets the band width of Mid/High EQ 2.

Gain [dB] [-18...+18]

Sets the gain of Mid/High EQ 2.

OUTPUT

This is the standard effects output section, with modulatable control over wet/dry balance. For more information, see “OUTPUT” on page 764.

029: Stereo Guitar Cabinet

This simulates the acoustical character of a guitar amp's speaker cabinet.

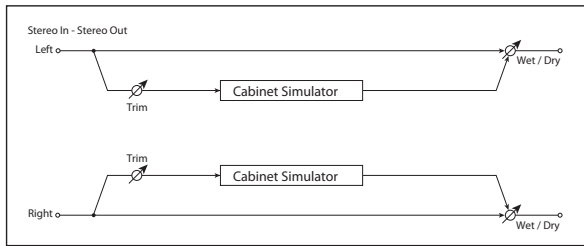

CABINET SIMULATOR

Trim [0...100]

Sets the input level.

Type [TWEED 1x12, TWEED 4x10, BLACK 2x10, BLACK 2x12, AC15, AC30, AD412, UK H30, UK T75, US V30]

Selects the type of the cabinet. See “031: Guitar Amp Model +Cabinet” on page 795.

Air [0...100]

Sets the mic position.

OUTPUT

This is the standard effects output section, with modulatable control over wet/dry balance. For more information, see “OUTPUT” on page 764.

030: Guitar Amp Model +P4EQ

This combines a guitar amp simulation (which even faithfully replicates the distortion and tone control circuitry) with a four-band equalizer.

For a description of the EQ graphic, see “011: Stereo Parametric 4EQ” on page 776.

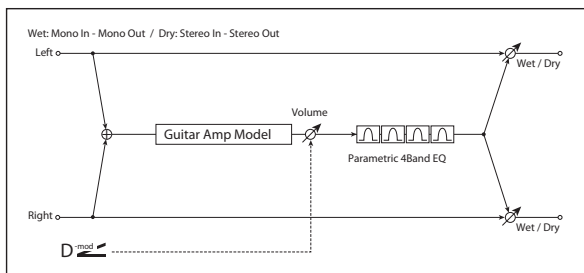

GUITAR AMP MODEL

Type [AC15, AC15TB, AC30, AC30TB, UK BLUES, UK 70'S, UK 80'S, UK 90'S, UK MODERN, US MODERN, US HIGAIN, BOUTIQUE OD, BOUTIQUE CL, BLACK 2x12, TWEED 1x12, TWEED 4x10]

Selects the type of the amplifier. For more information, see “Type” on page 795.

Gain [0...100]

Sets the input gain.

Volume [0...100]

Sets the output level.

Source [Off...Tempo]

Selects the modulation source for the output level.

Amount [+/-100]

Sets the modulation amount of the output level.

Bass [0...100]

Sets the bass (low range) level.

Middle [0...100]

Sets the middle (mid range) level.

Treble [0...100]

Sets the treble (high range) level.

Cut / Presence [0...100]

This controls the high-frequency tone.

If the **Type** is AC15...AC30TB, the **Cut** (high frequency attenuation) parameter is available. For other **Type** settings, the **Presence** (high frequency boost) parameter is available.

PARAMETRIC EQ

Band1 Fc [Hz] [20...1.00k]

Sets the center frequency of Band 1.

Q [0.5...10.0]

Sets Band 1's bandwidth.

Gain [dB] [-18...+18]

Sets the gain of Band 1.

Band2 Fc [Hz] [50...5.00k]

Sets the center frequency of Band 2.

Q [0.5...10.0]

Sets Band 2's bandwidth.

Gain [dB] [-18...+18]

Sets the gain of Band 2.

Band3 Fc [Hz] [300...10.00k]

Sets the center frequency of Band 3.

Q [0.5...10.0]

Sets Band 3's bandwidth.

Gain [dB] [-18...+18]

Sets the gain of Band 3.

- Band4 Fc [Hz]** [500...20.00k]
Sets the center frequency of Band 4.
- Q** [0.5...10.0]
Sets Band 4's bandwidth.
- Gain [dB]** [-18...+18]
Sets the gain of Band 4.

031: Guitar Amp Model +Cabinet

This simulates a guitar amp and speaker cabinet.

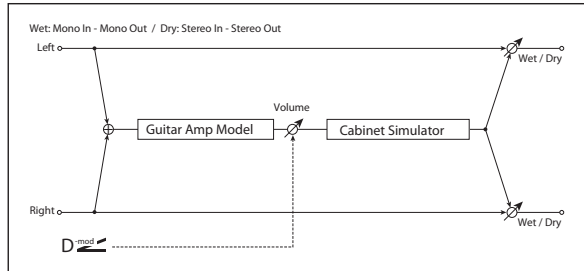

GUITAR AMP MODEL

Type [AC15, AC15TB, AC30, AC30TB, UK BLUES, UK 70'S, UK 80'S, UK 90'S, UK MODERN, US MODERN, US HIGAIN, BOUTIQUE OD, BOUTIQUE CL, BLACK 2x12, TWEED 1x12, TWEED 4x10]

Selects the type of the amplifier. For more information, see "Recommended Combinations of Guitar Amp Models and Cabinet Simulators" on page 796.

AC15: VOX AC15 manufactured in 1962.

AC15TB: VOX AC15TB (an AC15 modified by the addition of a top boost circuit).

AC30: Normal channel of a VOX AC30TB.

AC30TB: Brilliant channel of a VOX AC30TB.

UK BLUES: UK-manufactured vintage stack amp head.

UK 70'S: High treble channel of a UK-manufactured 100W amp head from 1969.

UK 80'S: UK-manufactured 100 Watt head from 1983.

UK 90'S: Lead channel of a 100W dual channel head.

UK MODERN: UK-manufactured 100W modern amp.

US MODERN: High-gain amp with metal plate.

US HIGAIN: 1991 model 100W amp head covered in snake- skin.

BOUTIQUE OD: Overdrive channel of a high-end 100W hand made amp.

BOUTIQUE CL: Clean channel of a high-end, hand-made 100W amp.

BLACK 2x12: 2x12 combo amp indispensable for country or blues players.

TWEED 1x12: Combo amp covered in tweed cloth.

TWEED 4x10: 4x10 combo amp designed for bass guitar.

Gain [0...100]
Sets the input gain.

OUTPUT

This is the standard effects output section, with modulatable control over wet/dry balance. For more information, see "OUTPUT" on page 764.

Volume [0...100]
Sets the output level.

Source [Off...Tempo]
Selects the modulation source for the output level.

Amount [+/–100]
Sets the modulation amount of the output level.

Bass [0...100]
Sets the bass (low range) level.

Middle [0...100]
Sets the middle (mid range) level.

Treble [0...100]
Sets the treble (high range) level.

Cut / Presence [0...100]
Sets the presence (high-frequency tone). p.794.

Cabinet Sim SW [Check-box]
Switches the cabinet simulator on/off.

CABINET SIMULATOR

Type [See Below]
Selects the type of the cabinet. p.796.

TWEED 1x12: Open-back cabinet with one 12" speaker, typically used for blues.

TWEED 4x10: Open-back cabinet with four 10" speakers.

BLACK 2x10: Open-back cabinet with two 10" speakers.

BLACK 2x12: American open-back cabinet with two 12" speakers.

AC15: Vox open-back cabinet with one 12" "Blue" speaker.

AC30: Vox open-back cabinet with two 12" "Blue" speakers.

AD412: VOX AD412 closed-back cabinet with four 12" speakers.

UK H30: Closed-back classic cabinet with four 30W 12" speakers.

UK T75: Closed-back cabinet with four 75W 12" speakers.

US V30: Closed-back cabinet with four 30W 12" speakers.

Air [0...100]
Sets the mic position.

OUTPUT

This is the standard effects output section, with modulatable control over wet/dry balance. For more information, see “OUTPUT” on page 764.

Recommended Combinations of Guitar Amp Models and Cabinet Simulators

| AMP MODEL | CABINET |
|-----------|---------|
| AC15 | AC15 |
| AC15TB | AC15 |
| AC30 | AC30 |
| AC30TB | AC30 |
| UK BLUES | UK H30 |
| UK 70'S | UK H30 |
| UK 80'S | UK T75 |

| AMP MODEL | CABINET |
|-------------|----------------|
| UK 90'S | UK T75 |
| UK MODERN | UK T75, US V30 |
| US MODERN | US V30 |
| US HIGAIN | US V30, UK T75 |
| BOUTIQUE OD | UK H30 |
| BOUTIQUE CL | UK H30 |
| BLACK 2x12 | BLACK 2x12 |
| TWEED 1x12 | TWEED 1x12 |
| TWEED 4x10 | TWEED 4x10 |

032: Stereo Bass Cabinet

This simulates the acoustical character of a bass amp's speaker cabinet.

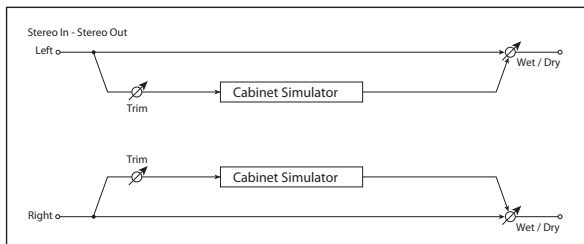

Type

[LA 4x10, MDN 4x10, MTL 4x10, CLS 8x10, UK 4x12, STD 1x15, JAZ 1x15, AC 2x15, US 2x15, UK 4x15, LA 1x18, COMBI]

Selects the cabinet type. See “034: Bass Amp Model +Cabinet” on page 797.

OUTPUT

This is the standard effects output section, with modulatable control over wet/dry balance. For more information, see “OUTPUT” on page 764.

CABINET SIMULATOR

Trim

[0...100]

Sets the input level.

033: Bass Amp Model

This simulates a bass amp.

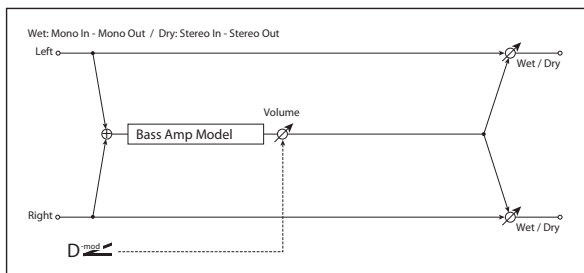

BASS AMP MODEL

Type

[LA STUDIO, JAZZ, GOLD PANEL, SCOOPED, VALVE2, VALVE, CLASSIC]

Selects the type of the amplifier. For more information, see “034: Bass Amp Model +Cabinet” on page 797.

Volume

[0...100]

Sets the output level.

Source

[Off...Tempo]

Selects the modulation source for the output level.

Amount

[+/-100]

Sets the modulation amount of the output level.

Bass

[0...100]

Sets the bass (low range) level.

Middle [0...100]
Sets the middle (mid range) level.

Mid Range [0...4]
Sets the mid-frequency range.

Treble [0...100]
Sets the treble (high range) level.

Presence [0...100]
Sets the presence (high-frequency tone).

OUTPUT

This is the standard effects output section, with modulatable control over wet/dry balance. For more information, see “OUTPUT” on page 764.

034: Bass Amp Model +Cabinet

This simulates a bass amp and speaker cabinet.

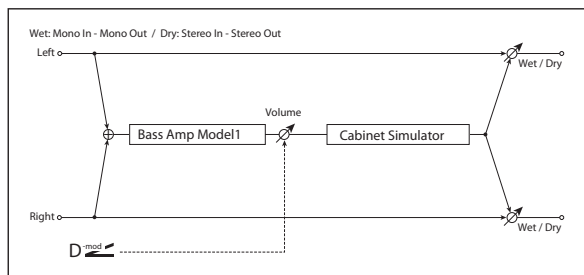

BASS AMP MODEL

Type [LA STUDIO, JAZZ, GOLD PANEL, SCOOPED, VALVE2, VALVE, CLASSIC]

Selects the amplifier type. See “Recommended Combinations of Bass Amp Models and Cabinets” on page 798.

LA STUDIO: An amp typical of the LA sound.

JAZZ: A combo amp favored by jazz bassists.

GOLD PANEL: An amp distinctive for its eye-catching gold panel and clean sound.

SCOOPED: An amp typical of 80’s sounds.

VALVE2: A tube amp suitable for rock.

VALVE: A tube amp with the ULTRA LO switch turned ON.

CLASSIC: A tube amp whose basic character changes according to the setting of the value dial.

Volume [0...100]
Sets the output level.

Source [Off...Tempo]
Selects the modulation source for the output level.

Amount [+/-100]
Sets the modulation amount of the output level.

Bass [0...100]
Sets the bass (low range) level.

Middle [0...100]
Sets the middle (mid range) level.

Mid Range [0...4]
Sets the mid-frequency range.

Treble [0...100]
Sets the treble (high range) level.

Presence [0...100]
Sets the presence (high-frequency tone).

CABINET SIMULATOR

Cabinet Sim SW [Check-box]
Switches the cabinet simulator on/off.

Type [LA 4x10, MDN 4x10, MTL 4x10, CLS 8x10, UK 4x12, STD 1x15, JAZ 1x15, AC 2x15, US 2x15, UK 4x15, LA 1x18, COMBI]

Selects the cabinet type. See “Recommended Combinations of Bass Amp Models and Cabinets” on page 798.

LA 4x10: Four 10” speakers; LA sound.

MDN 4x10: Four 10” speakers; modern cabinet.

MTL 4x10: Four 10” aluminum-cone speakers; modern cabinet.

CLS 8x10: Eight 10” speakers; classic cabinet.

UK 4x12: Four 12” speakers; UK-manufactured cabinet.

STD 1x15: One 15” speaker; studio combo cabinet.

JAZ 1x1: One 15” speaker; jazz combo cabinet.

AC 2x15: Two 15” speakers; cabinet for AC100.

US 2x15: Two 15” speakers; US-manufactured cabinet.

UK 4x15: Four 15” speakers; UK-manufactured cabinet.

LA 1x18: One 18” speaker; LA sound.

COMBI: One 12” and one 18” speaker combination cabinet.

OUTPUT

This is the standard effects output section, with modulatable control over wet/dry balance. For more information, see “OUTPUT” on page 764.

Recommended Combinations of Bass Amp Models and Cabinets

| AMP MODEL | CABINET |
|------------|--------------------|
| LA STUDIO | LA 4X10 or LA 1X18 |
| JAZZ | JAZ 1X15 |
| GOLD PANEL | MDN 4X10 |
| SCOOPED | MTL 4X10 |
| VALVE2 | CLS 8X10 |
| VALVE | CLS 8X10 |
| CLASSIC | COMBI |

035: Bass Amp TubeDrive +Cab

This simulates a bass amp (with gain and drive) and speaker cabinet.

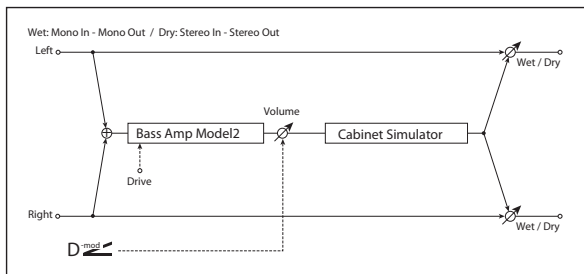

BASS AMP MODEL

Amplifier Type [STUDIO, AC100, UK MAJOR]

Selects the type of the amplifier. p.798.

STUDIO: A tube combo ideal for the Motown sound.

AC100: A 100W tube amp made by Vox.

UK MAJOR: A 200W tube amp made in the UK.

Gain [0...100]

Sets the input gain.

Volume [0...100]

Sets the output level.

Source [Off...Tempo]

Selects the modulation source for the output level.

Amount [+/-100]

Sets the modulation amount of the output level.

Bass [0...100]

Sets the bass (low range) level.

Middle [0...100]

Sets the middle (mid range) level.

Treble [0...100]

Sets the treble (high range) level.

Presence [0...100]

Sets the presence (high-frequency tone).

CABINET SIMULATOR

Cabinet Sim SW [Check-box]

Switches the cabinet simulator on/off.

Cabinet Type [LA 4x10, MDN 4x10, MTL 4x10, CLS 8x10, UK 4x12, STD 1x15, JAZ 1x15, AC 2x15, US 2x15, UK 4x15, LA 1x18, COMBI]

Selects the cabinet type. See “034: Bass Amp Model +Cabinet” on page 797, and “Recommended Combinations of Bass Amp Models and Cabinets” on page 798.

OUTPUT

This is the standard effects output section, with modulatable control over wet/dry balance. For more information, see “OUTPUT” on page 764.

Recommended Combinations of Bass Amp Models and Cabinets

| AMP MODEL | CABINET |
|-----------|------------------|
| STUDIO | STD 1X15 |
| AC100 | AC 2X15 |
| UK MAJOR | UK 4X15, UK 4X12 |

036: Tube PreAmp Modeling

This effect simulates a two-stage vacuum tube preamp. You can make individual settings for two vacuum tubes connected in series. This lets you create the warm sound typical of vacuum tubes.

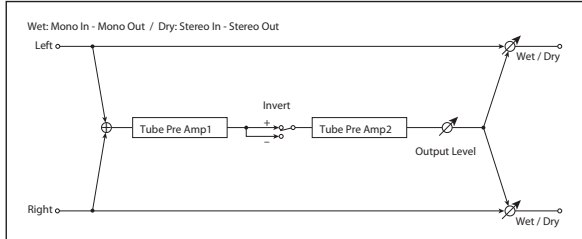

TUBE PREAMP1

Low Cut [Hz] [Thru, 21...8.00k]

Sets the cutoff frequency for the low cut filter of stage 1.

High Cut [Hz] [53...20.00k, Thru]

Sets the cutoff frequency for the high cut filter of stage 1.

Gain [dB] [-Inf, -38...+24]

Sets the input gain for stage 1.

Saturation [%] [0...100]

Sets the input/output response for stage 1. See “Saturation [%]” on page 800.

Bias [0...100]

Sets the bias voltage for stage 1. See “Bias” on page 800.

Phase [Normal, Wet Invert]

Turns phase reversal on/off.

With the Wet Invert setting, the phase of the signal will be inverted between stage 1 and stage 2. Since “Bias” is applied to the inverted signal in stage 2, this will change the tonal character.

TUBE PREAMP2

Low Cut [Hz] [Thru, 21...8.00k]

High Cut [Hz] [53...20.00k, Thru]

Gain [dB] [-24.0...+24.0]

Saturation [%] [0...100]

Bias [0...100]

These parameters are identical to those for “TUBE PREAMP1,” above.

Output Level [dB] [-48.0...+0.0]

Sets the output level.

OUTPUT

Wet/Dry [Dry, 1:99...99:1, Wet]

Sets the balance between the effect and the dry input.

Source [Off...Tempo]

Selects a modulation source for Wet/Dry.

Amount [+/-100]

Sets the modulation amount for Wet/Dry.

037: St. Tube PreAmp Modeling

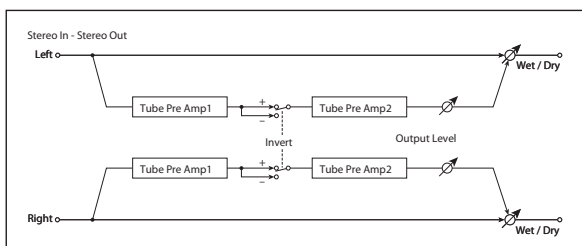

This is similar to “036: Tube PreAmp Modeling”, but in stereo.

For more information, see “036: Tube PreAmp Modeling” on page 799.

038: Mic Modeling +PreAmp

This effect simulates a mic and vacuum tube preamp. You can choose from various types of mic and positions to create differing sonic characters.

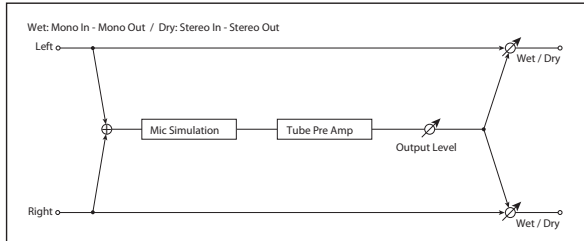

MIC SIMULATOR

Type [Vnt.Dy/55SH, Mlt.Cn/C414, Pc.Cn/C451, Whale/MD421, Vo.Dy/SM58, Mlt.Dy/SM57, Vo.Cn/U87, Vo.Tube/U47, BDr.Dy/RE20]

Selects the type of mic.

Position [Close, On, Off, Far]

This expresses the effect that the mic position has on the sound. The Close setting is the closest mic position, and the Far setting is the farthest.

TUBE PREAMP

Low Cut [Hz] [Thru, 21...8.00k]

Sets the frequency of the low cut filter.

High Cut [Hz] [53...20.00k, Thru]

Sets the frequency of the high cut filter.

Gain [dB] [-24.0...+24.0]

Sets the input gain to the vacuum tube preamp.

Saturation [%] [0...100]

Sets the input/output response of the preamp.

At higher settings, the waveform will change at high gain levels, tending to cause distortion. Lower settings will produce linear response.

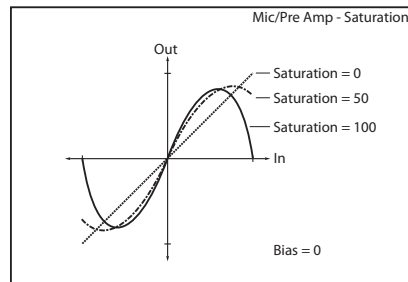

Bias

[0...100]

This expresses the effect that changes in vacuum tube bias have on the distortion of the waveform. Higher settings of this value will produce distortion even at low gain levels. Since this will also change the overtone structure, you can use it to control the tonal character.

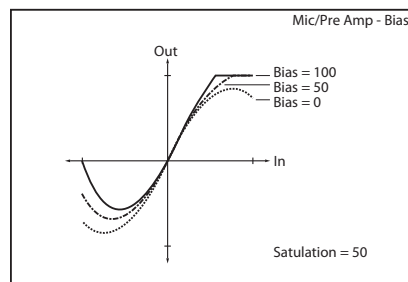

Output Level [dB]

[-48.0...+0.0]

Sets the output level of the preamp.

OUTPUT

This is the standard effects output section, with modulatable control over wet/dry balance. For more information, see "OUTPUT" on page 764.

039: St. Mic Modeling +PreAmp

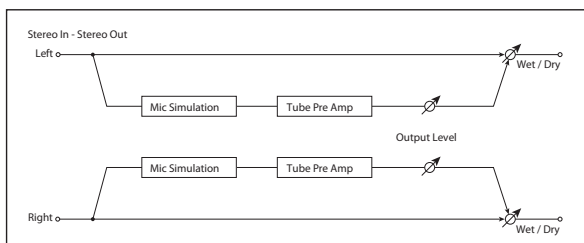

This is similar to "038: Mic Modeling +PreAmp", but in stereo. For example, you might use this to simulate mic'ing of a stereo source such as a rotary speaker.

For more information, see "038: Mic Modeling +PreAmp" on page 800.

Chorus, Flanger, and Phaser

040: Stereo Chorus

This effect adds thickness and warmth to the sound by modulating the delay time of the input signal. You can add spread to the sound by offsetting the phase of the left and right LFOs from each other.

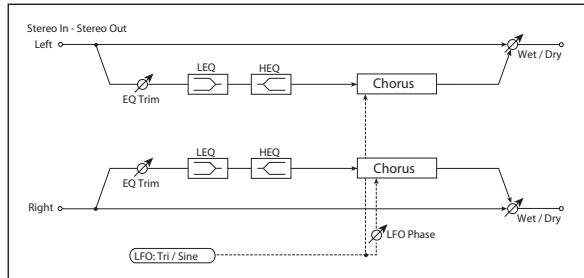

Pre EQ

Trim [0...100]

Sets the EQ input level.

LEQ Fc [Low, Mid-Low]

Selects the cutoff frequency (low or mid-low) of the low-range equalizer.

LEQ Gain [dB] [-15.0...+15.0]

Sets the gain of the Low EQ.

HEQ Fc [High, Mid-High]

Selects the cutoff frequency (high or mid-high) of the high-range equalizer.

HEQ Gain [dB] [-15.0...+15.0]

Sets the gain of the High EQ.

LFO

Waveform [Triangle, Sine]

Selects the LFO Waveform.

Phase [degrees] [-180...+180]

Sets the LFO phase difference between the left and right. See “Phase [degrees]” on page 783.

Frequency [Hz] [0.02...20.00]

This sets the LFO speed, in Hz. It applies only when **MIDI/Tempo Sync**, below, is **Off**.

Source [Off...Tempo]

This selects a modulation source for the **Frequency**.

Amount [-20.00...+20.00]

This sets the **Frequency** modulation amount, in Hz.

MIDI/Tempo Sync [Check-box]

BPM [MIDI, 40.00...300.00]

Base Note [♪...♩]

Times [x1...x32]

When **MIDI/Tempo Sync** is on, the LFO speed is set by **BPM**, **Base Note**, and **Times**, instead of **Frequency**. For more information, see “MIDI/Tempo Sync” on page 781.

Type [Individual, Common1, Common2]

This controls whether the effect uses its individual LFO, or one of the Common FX LFOs. For more information, see “LFO Type” on page 781.

Common LFO Phase Offset [degrees] [+/-180]

When **Type** is set to **Common FX LFO 1** or **2**, this lets you offset the phase from the master LFO.

CHORUS

L Pre Delay [msec] [0.0...50.0]

Sets the delay time for the left channel. Setting the left and right delay times to slightly different values allows you to control the stereo image.

R Pre Delay [msec] [0.0...50.0]

Sets the delay time for the right channel.

Depth [0...100]

Sets the depth of LFO modulation.

Source [Off...Tempo]

Selects the modulation source for the LFO modulation depth.

Amount [+/-100]

Sets the modulation amount of the LFO modulation depth.

OUTPUT

This is the standard effects output section, with modulatable control over wet/dry balance. For more information, see “OUTPUT” on page 764.

041: Stereo Harmonic Chorus

This effect applies chorus only to higher frequencies. This can be used to apply a chorus effect to a bass sound without making the sound thinner. You can also use feedback to turn the chorus into a flanger.

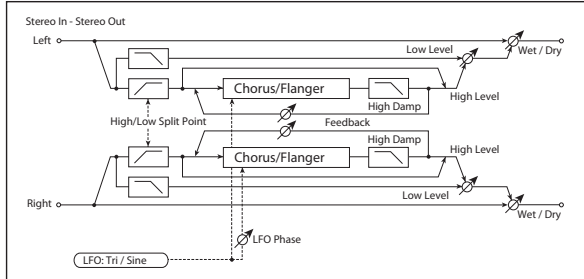

CHORUS

Pre Delay [msec] [0.0...50.0]

Sets the delay time from the original sound.

Depth D_{mod} [0...100]

Sets the depth of LFO modulation.

Source [Off...Tempo]

Selects the modulation source of the LFO modulation depth.

Amount [+/-100]

Sets the modulation amount of the LFO modulation depth.

Feedback [+/-100]

Sets the feedback amount for the chorus. Increasing the feedback turns the chorus into a flanger.

High Damp [%] [0...100]

Sets the amount of high-frequency attenuation for the chorus.

High/Low Split Point [1...100]

This sets the frequency split point between the low and high ranges. Only the high range will be processed through the chorus.

Low Level [0...100]

Sets the low range output level.

High Level [0...100]

Sets the high range (chorus) output level.

LFO

Waveform [Triangle, Sine]

Selects the LFO Waveform.

Phase [degrees] [-180...+180]

Sets the LFO phase difference between the left and right. See “Phase [degrees]” on page 783.

Frequency [Hz] D_{mod} [0.02...20.00]

This sets the LFO speed, in Hz. It applies only when **MIDI/Tempo Sync**, below, is **Off**.

Source [Off...Tempo]

This selects a modulation source for the **Frequency**.

Amount [-20.00...+20.00]

This sets the **Frequency** modulation amount, in Hz.

MIDI/Tempo Sync D_{mod} [Check-box]

BPM [MIDI, 40.00...300.00]

Base Note [♩...♩]

Times [x1...x32]

When **MIDI/Tempo Sync** is on, the LFO speed is set by **BPM**, **Base Note**, and **Times**, instead of **Frequency**. For more information, see “MIDI/Tempo Sync” on page 781.

Type [Individual, Common1, Common2]

This controls whether the effect uses its individual LFO, or one of the Common FX LFOs. For more information, see “LFO Type” on page 781.

Common LFO Phase Offset [degrees] [+/-180]

When **Type** is set to **Common FX LFO 1** or **2**, this lets you offset the phase from the master LFO.

OUTPUT

This is the standard effects output section, with modulatable control over wet/dry balance. For more information, see “OUTPUT” on page 764.

042: St. Bi-phase Modulation

This stereo chorus effect adds two different LFOs together. You can set the Frequency and Depth parameters for each LFO individually. Depending on the setting of these LFOs, very complex waveforms will create an analog-type, unstable modulated sound.

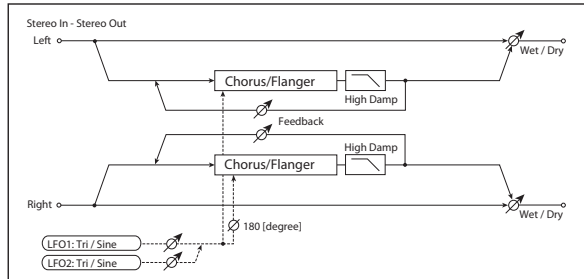

MODULATION

L Pre Delay [msec] [0.0...50.0]

Sets the delay time for the left channel. p.801.

R Pre Delay [msec] [0.0...50.0]

Sets the delay time for the right channel. p.801.

Depth1 D_{mod} [0...100]

Sets the depth of LFO1 modulation.

Depth2 D_{mod} [0...100]

Sets the depth of LFO2 modulation.

Source [Off...Tempo]

Selects the modulation source of LFO1&2 modulation depth.

Amount1 [+/-100]

Sets the modulation amount of LFO1 modulation depth.

Amount2 [+/-100]

Sets the modulation amount of LFO2 modulation depth.

Feedback [+/-100]

Sets the feedback amount. See “Feedback” on page 802.

High Damp [%] [0...100]

Sets the amount of high-frequency attenuation.

LFO1/2

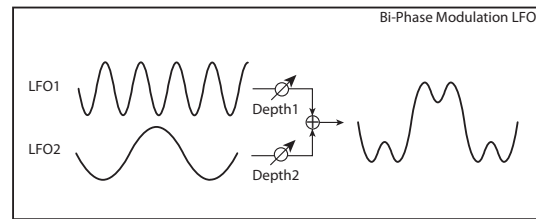

LFO1 Waveform [Triangle, Sine]

Selects the waveform for LFO1.

LFO2 Waveform [Triangle, Sine]

Selects the waveform for LFO2.

Phase Sw [0 degree, 180 degree]

This lets you invert the LFO phase between the left and right channels.

LFO1 Frequency [Hz] D_{mod} [0.02...30.00]

This sets the speed of LFO1, in Hz.

LFO2 Frequency [Hz] D_{mod} [0.02...30.00]

This sets the speed of LFO2, in Hz.

Source [Off...Tempo]

Selects a source to modulate the speeds of LFO1 & 2.

LFO1 Amount [-30.00...+30.00]

This sets the LFO1 Frequency modulation amount, in Hz.

LFO2 Amount [-30.00...+30.00]

This sets the LFO2 Frequency modulation amount, in Hz.

LFO1 Type [Individual, Common1, Common2]

This controls whether the effect uses its individual LFO1, or one of the Common FX LFOs. For more information, see “LFO Type” on page 781.

Common LFO Phase Offset [degrees] [+/-180]

When **Type** is set to **Common FX LFO 1** or **2**, this lets you offset the phase from the master LFO.

LFO2 Type [Individual, Common1, Common2]

This controls whether the effect uses its individual LFO2, or one of the Common FX LFOs. For more information, see “LFO Type” on page 781.

Common LFO Phase Offset [degrees] [+/-180]

When **Type** is set to **Common FX LFO 1** or **2**, this lets you offset the phase from the master LFO.

OUTPUT

This is the standard effects output section, with modulatable control over wet/dry balance. For more information, see “OUTPUT” on page 764.

043: Multitap Cho/Delay 4Taps

This effect has four chorus blocks, each with a different LFO phase. You can create a complex stereo image by setting each block's delay time, depth, output level, and pan individually. You can also fix some of the chorus blocks to combine the chorus and delay effects.

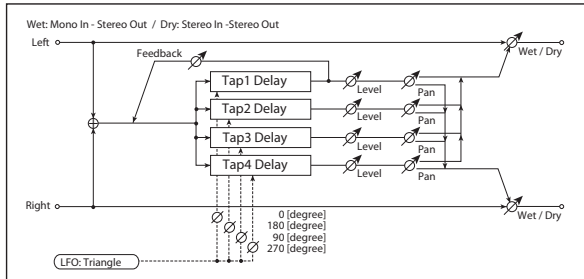

MOD DELAY

Taps 1-4

There are four delay taps, each with separate settings for delay time, chorus depth, level, and pan. The chorus LFO phases are different for each tap:

Tap 1 = 0 degrees

Tap 2 = 180 degrees

Tap 3 = 90 degrees

Tap 4 = 270 degrees

Tap 1...4 [msec] [0...1000]

This sets the tap's delay time.

Depth 1...4 [0...30]

This sets the tap's chorus depth.

Level 1...4 [0...30]

This sets the tap's output level.

Pan 1...4 [L6...L1, C, R1...R6]

This sets the tap's stereo position.

Tap 1 Feedback

Tap 1 Feedback [+/-100]

Sets the Tap1 feedback amount.

Source [Off...Tempo]

Selects the modulation source of Tap1 feedback amount and effect balance.

Amount [+/-100]

Sets the Tap1 feedback amount and modulation amount.

LFO

Frequency [Hz] [0.02...13.00]

This sets the LFO speed, in Hz.

LFO Type [Individual, Common1, Common2]

This controls whether the effect uses its individual LFO, or one of the Common FX LFOs. For more information, see "LFO Type" on page 781.

Common LFO Phase Offs [deg] [-180...+180]

When Type is set to **Common FX LFO 1** or **2**, this lets you offset the phase from the master LFO.

OUTPUT

This is the standard effects output section, with modulatable control over wet/dry balance. For more information, see "OUTPUT" on page 764.

044: Multitap Cho/Delay 6Taps

This effect has six chorus blocks with different LFO phases. You can produce a complex stereo image by setting a different delay time and depth for each block. You can control the delay output level via a modulation source.

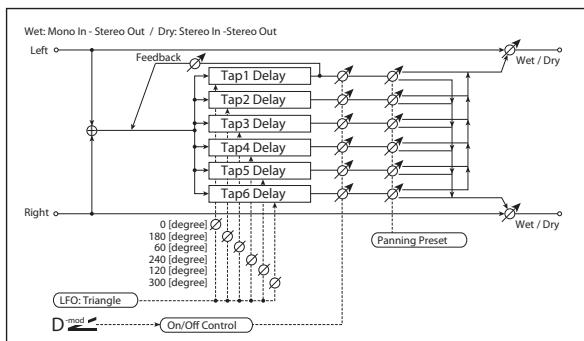

MODULATION DELAY

Taps 1-6

There are six delay taps, each with separate settings for delay time, chorus depth, and on/off/modulation status. The chorus LFO phases are different for each tap:

Tap 1 = 0 degrees

Tap 2 = 180 degrees

Tap 3 = 60 degrees

Tap 4 = 240 degrees

Tap 5 = 120 degrees

Tap 6 = 300 degrees

Tap 1...6 [msec] [0...2000]

This sets the tap's delay time.

Depth 1...6 [0...30]

This sets the tap's chorus depth.

Status 1...6 [Always On, Always Off, On→Off (Dmod), Off→On (Dmod)]

This turns the tap on or off, or allows its output level to be modulated by the selected Dmod source.

Always On: Output is always on. (No modulation)

Always Off: Output is always off. (No modulation)

On→Off (Dmod): Output level fades from on to off via the modulation source.

Off→On (Dmod): Output level fades from off to on via the modulation source.

Combining these parameters, you can change from 4-phase chorus to two-tap delay by crossfading them gradually via the modulation source during a performance.

Tap 1 Feedback

Tap1 Feedback D_{mod} [+/-100]

Sets the amount of feedback from Tap1.

Source [Off...Tempo]

This selects a modulation source to modulate the tap output levels (as set by **Status**, above) and the **Tap 1 Feedback** amount.

Amount [+/-100]

Sets the modulation amount for the **Tap 1 Feedback**.

Panning Preset [1: L 1 2 3 4 5 6 R, 2: L 1 3 5 2 4 6 R, 3: L 1 3 5 2 4 6 R, 4: L 1 4 5 6 3 2 R]

This selects combinations of stereo panning patterns for the tap outputs.

LFO

Frequency [Hz] [0.02...13.00]

This sets the LFO speed, in Hz.

OUTPUT

This is the standard effects output section, with modulatable control over wet/dry balance. For more information, see “OUTPUT” on page 764.

045: Bi Chorus

This effect lets you place two independent chorus/flanger units in series or in parallel. If placed in series, feedback can be applied to the sound that has passed through the two chorus modules, creating even more complex modulation.

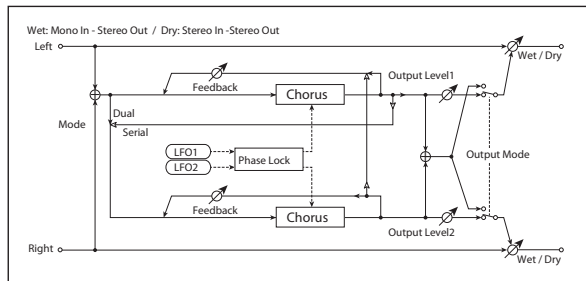

CHORUS1

Manual [0...100]

Sets the delay time for chorus 1.

LFO1 Depth D_{mod} [0...100]

Sets the LFO modulation depth for chorus 1.

Source [Off...Tempo]

Selects the modulation source that will control LFO modulation depth.

Amount [+/-100]

Sets the amount by which the chorus 1 LFO modulation depth will be controlled.

Feedback [0...100]

Sets the feedback amount for chorus 1.

CHORUS2

Manual [0...100]

Sets the delay time for chorus 2.

LFO2 Depth D_{mod} [0...100]

Sets the LFO modulation depth for chorus 2.

Amount [+/-100]

Sets the amount by which the chorus 2 LFO modulation depth will be controlled.

Feedback [0...100]

Sets the feedback amount for chorus 2. When **Routing** is set to **Serial**, this feeds back into Chorus 1, and Chorus 1’s own **Feedback** setting is ignored.

LFO1/2

LFO1/2 Lock [Unlock, Lock-LFO1, Lock-Common1, Lock-Common2]

This selects the LFO(s) used by the two choruses.

Unlock: LFO 1 and LFO 2 will operate independently.

Lock-LFO 1: both choruses will use LFO 1, with an optional phase offset for LFO 2 (see “LFO2 Phase [degrees],” below).

Lock-Common 1 or Lock Common 2: both choruses will use the selected FX Common LFO, with an optional phase offset for LFO 2.

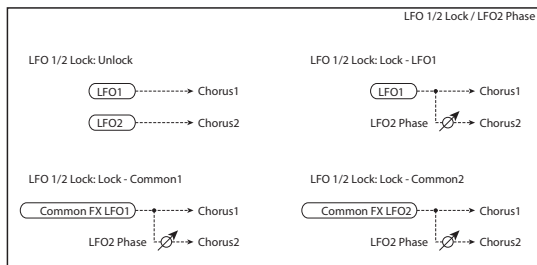

LFO2 Phase [degrees] [-180...+180]

Sets the phase difference between LFO1 and LFO2, when **LFO 1/2 Lock** is set to anything other than **Unlock**.

LFO1 Frequency [Hz] [0.02...20.00]

Sets the LFO 1 speed. This applies only if **LFO 1/2 Lock** is set to **Unlock** or **Lock-LFO1**.

LFO2 Frequency [Hz] [0.02...20.00]

Sets the LFO 2 speed. This applies only if **LFO 1/2 Lock** is set to **Unlock**.

Source [Off...Tempo]

Selects a source to modulate the speeds of LFO1 & 2.

LFO1 Amount [-20.00...+20.00]

This sets the **LFO1 Frequency** modulation amount, in Hz.

LFO2 Amount [-20.00...+20.00]

This sets the **LFO2 Frequency** modulation amount, in Hz.

MIDI/Tempo Sync [Check-box]

BPM [MIDI, 40.00...300.00]

LFO1 Note [Musical Note]

Times [x1...x32]

LFO2 Note [Musical Note]

Times [x1...x32]

When **MIDI/Tempo Sync** is on, the LFO speeds are set by **BPM**, **Note**, and **Times**, instead of **Frequency**. The two LFOs each have their own settings for **Note** and **Times**. For more information, see “MIDI/Tempo Sync” on page 781.

MODE

Chorus 1 and 2 are connected as shown in the diagram.

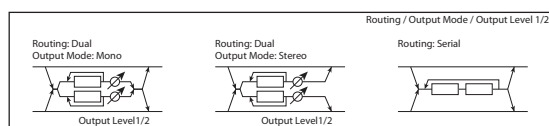

Routing [Dual, Serial]

Selects parallel or serial connection for chorus 1 and 2.

If **Routing** is set to **Serial**, the **Chorus 1 Output Level**, **Chorus 2 Output Level**, and **Chorus 2 Feedback** settings are ignored.

Output Mode [Mono, Stereo]

This applies only when **Routing** is set to **Dual**.

Mono: The outputs of both chorus 1 and 2 are summed together and panned to the center.

Stereo: Chorus 1 goes to the left output, and chorus 2 goes to the right output.

Chorus1 Output Level [0...100]

Sets the output level for chorus 1.

Chorus2 Output Level [0...100]

Sets the output level for chorus 2.

OUTPUT

This is the standard effects output section, with modulatable control over wet/dry balance. For more information, see “OUTPUT” on page 764.

046: Ensemble

This Ensemble effect has three chorus blocks that use LFO to create subtle shimmering, and gives three dimensional depth and spread to the sound, because the signal is output from the left, right, and center.

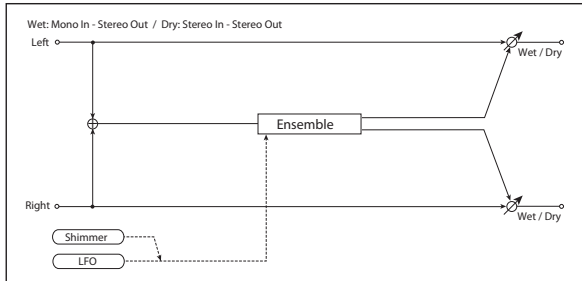

ENSEMBLE

Depth D_{mod} [0...100]

Sets the depth of the LFO modulation.

Source [Off...Tempo]

Selects the modulation source for the LFO depth.

Amount [+/-100]

Sets the modulation amount of the LFO modulation depth.

LFO

Speed D_{mod} [1...100]

Sets the LFO speed.

Source [Off...Tempo]

Selects a modulation source for LFO speed.

Amount [+/-100]

Sets the modulation amount of LFO speed.

Shimmer [0...100]

This parameter sets the amount of shimmering of the LFO waveform. Increasing this value adds more shimmering, making the chorus effect more complex and richer.

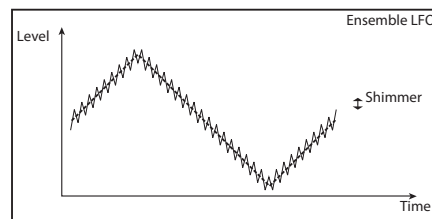

OUTPUT

This is the standard effects output section, with modulatable control over wet/dry balance. For more information, see "OUTPUT" on page 764.

047: Polysix Ensemble

This models the ensemble effect built into the classic Korg PolySix programmable polyphonic synthesizer.

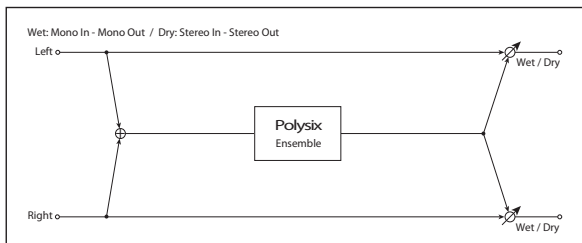

POLYSIX ENSEMBLE

Depth D_{mod} [0...100]

Sets the depth of the effect.

Source [Off...Tempo]

Selects the modulation source that will control the effect depth.

Amount [+/-100]

Sets the amount by which the effect depth will be modulated.

OUTPUT

This is the standard effects output section, with modulatable control over wet/dry balance. For more information, see "OUTPUT" on page 764.

048: Stereo Flanger

This effect gives a significant swell and movement of pitch to the sound. It is more effective when applied to a sound with a lot of harmonics. This is a stereo flanger. You can add spread to the sound by offsetting the phase of the left and right LFOs from each other.

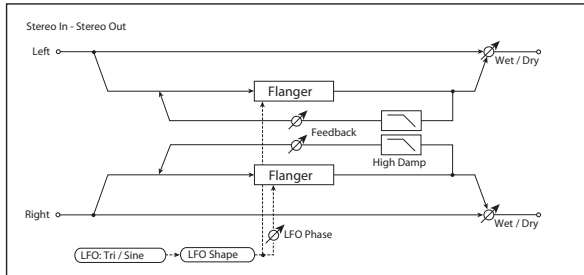

FLANGER

Delay Time [msec] [0.0...50.0]

Sets the delay time from the original sound.

Depth [0...100]

Sets the depth of LFO modulation.

Feedback [±100]

This controls the intensity of the flanger effect. Positive and negative values create different timbres.

Mixing the processed and dry signals via **Wet/Dry** will enhance the effect. For maximum intensity, set **Feedback** and **Wet/Dry** so that they are either both positive or both negative; this emphasizes the flanger's harmonic peaks.

High Damp [%] [0...100]

This sets the amount of high-frequency attenuation in the flanger's feedback loop. Increasing the value will reduce high-frequency harmonics.

LFO

Waveform [Triangle, Sine]

Selects the LFO Waveform.

Shape [±100]

Changes the curvature of the LFO Waveform. p.784.

Phase [degrees] [-180...+180]

Sets the LFO phase difference between the left and right. See "Phase [degrees]" on page 783.

Frequency [Hz] D_{mod} [0.02...20.00]

This sets the LFO speed, in Hz. It applies only when **MIDI/Tempo Sync**, below, is **Off**.

Source [Off...Tempo]

This selects a modulation source for the **Frequency**.

Amount [-20.00...+20.00]

This sets the **Frequency** modulation amount, in Hz.

MIDI/Tempo Sync D_{mod} [Check-box]

BPM [MIDI, 40.00...300.00]

Base Note [Musical Note]

Times [x1...x32]

When **MIDI/Tempo Sync** is on, the LFO speed is set by **BPM**, **Base Note**, and **Times**, instead of **Frequency**. For more information, see "MIDI/Tempo Sync" on page 781.

Type [Individual, Common1, Common2]

This controls whether the effect uses its individual LFO, or one of the Common FX LFOs. For more information, see "LFO Type" on page 781.

Common LFO Phase Offset [degrees] [±180]

When **Type** is set to **Common FX LFO 1** or **2**, this lets you offset the phase from the master LFO.

OUTPUT

Wet/Dry D_{mod} [-Wet...-1:99, Dry, 1: 99...Wet]

Sets the balance between the "wet" processed sound and the dry input. Negative values invert the phase of the wet signal. This interacts with **Feedback**; for more information, see "Feedback" on page 808.

Source [Off...Tempo]

Selects a modulation source for **Wet/Dry**.

Amount [±100]

Sets the modulation amount for **Wet/Dry**.

049: Stereo Random Flanger

The stereo effect uses a step-shape waveform and random LFO for modulation, creating a unique flanging effect.

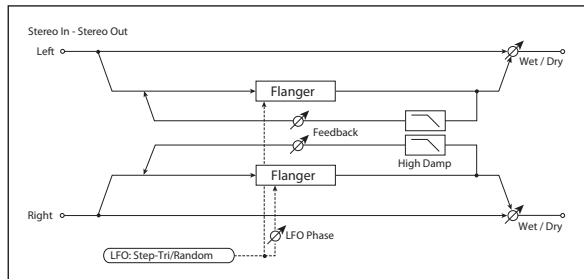

FLANGER

Delay Time [msec] [0.0...50.0]

Sets the delay time from the original sound.

Depth [0...100]

Sets the depth of LFO modulation.

Feedback [+/-100]

This controls the intensity of the flanger. For more information, see “Feedback” on page 808.

High Damp [%] [0...100]

This sets the amount of high-frequency attenuation in the flanger’s feedback loop. Increasing the value will reduce high-frequency harmonics.

LFO

These parameters control the shape and speed of the step LFO. They are identical to those in the Stereo Random Filter; for more information, see “LFO” on page 783.

OUTPUT

Wet/Dry [-Wet...-1:99, Dry, 1: 99...Wet]

Sets the balance between the “wet” processed sound and the dry input. Negative values invert the phase of the wet signal. This interacts with **Feedback**; for more information, see “Feedback” on page 808.

Source [Off...Tempo]

Selects a modulation source for Wet/Dry.

Amount [+/-100]

Sets the modulation amount for Wet/Dry.

050: Stereo Envelope Flanger

This Flanger uses a MIDI-triggerable envelope generator for modulation. This lets you create sequences with flanger sweeps which always happen on the same beat, for instance. You can also control the Flanger directly using a modulation source.

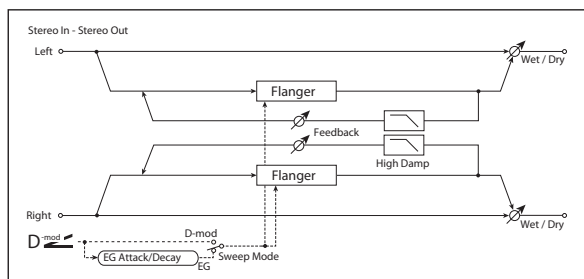

CONTROL

Sweep Mode [EG, Dmod]

When **Sweep Mode** is set to **EG**, the envelope generator controls the flanger. Note that this is the effect’s own EG, and isn’t related to the Program’s other EGs (Filter, Amp, etc.).

The **Source** parameter, below, selects the source that starts the envelope generator. If you select Gate, for example, the envelope will be triggered by note-ons.

MIDI The EG is triggered when the MIDI source’s value changes from 63 or smaller to 64 or higher.

When **Sweep Mode** is set to **Dmod**, the modulation source directly controls the flanger. Select the modulation source using the **Source** parameter, below.

Source [Off...Tempo]

Selects the modulation source that triggers the EG (when **Sweep Mode** = **EG**), or the modulation source that causes the flanger to sweep (when **Sweep Mode** = **Dmod**).

EG

Attack [1...100]

Sets the EG attack time. For more information Attack and Release, see the graphic under “Attack [msec]” on page 766.

Decay [1...100]

Sets the EG decay time.

FLANGER

L Delay Bottom [msec] [0.0...50.0]

Sets the lower limit of the left-channel delay time. For more information on the Bottom and Top settings, see the graphic under “Frequency Bottom” on page 781.

L Delay Top [msec] [0.0...50.0]

Sets the upper limit of the left-channel delay time.

R Delay Bottom [msec] [0.0...50.0]

Sets the lower limit of the right-channel delay time.

R Delay Top [msec] [0.0...50.0]

Sets the upper limit of the right-channel delay time.

Feedback [+/-100]

This controls the intensity of the flanger. For more information, see “Feedback” on page 808.

High Damp [%] [0...100]

This sets the amount of high-frequency attenuation in the flanger’s feedback loop. Increasing the value will reduce high-frequency harmonics.

OUTPUT**Wet/Dry** [-Wet...-1:99, Dry, 1: 99...Wet]

Sets the balance between the “wet” processed sound and the dry input. Negative values invert the phase of the wet signal. This interacts with **Feedback**; for more information, see “Feedback” on page 808.

Source [Off...Tempo]

Selects a modulation source for Wet/Dry.

Amount [+/-100]

Sets the modulation amount for Wet/Dry.

051: Stereo Phaser

This effect creates a swell by shifting the phase. It is very effective on electric piano sounds. You can add spread to the sound by offsetting the phase of the left and right LFOs from each other

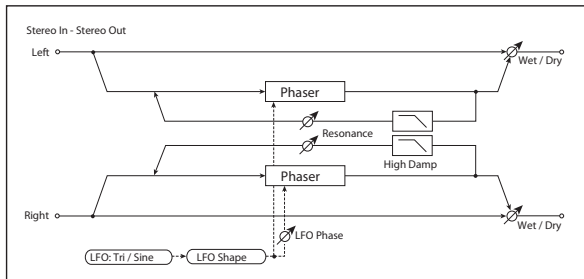
**PHASER****Manual** [0...100]

Sets the phaser’s center frequency.

Depth [0...100]

Sets the depth of LFO modulation.

Source [Off...Tempo]

Selects the modulation source for the LFO modulation depth.

Amount [+/-100]

Sets the modulation amount of the LFO modulation depth.

Resonance [+/-100]

This controls the intensity of the phaser effect. Positive and negative values create different timbres.

Mixing the processed and dry signals via **Wet/Dry** will enhance the effect. For maximum intensity, set **Resonance** and **Wet/Dry** so that they are either both positive or both negative; this emphasizes the phaser’s harmonic peaks.

High Damp [%] [0...100]

This sets the amount of high-frequency attenuation in the phaser’s feedback loop. Increasing the value will reduce high-frequency harmonics.

LFO**Waveform** [Triangle, Sine]

Selects the LFO Waveform.

Shape [+/-100]

Changes the curvature of the LFO Waveform. p.784.

Phase [degrees] [-180...+180]

Sets the LFO phase difference between the left and right. See “Phase [degrees]” on page 783.

Frequency [Hz] [0.02...20.00]

This sets the LFO speed, in Hz. It applies only when **MIDI/Tempo Sync**, below, is **Off**.

Source [Off...Tempo]

This selects a modulation source for the **Frequency**.

Amount [-20.00...+20.00]

This sets the **Frequency** modulation amount, in Hz.

MIDI/Tempo Sync [Check-box]**BPM** [MIDI, 40.00...300.00]**Base Note** [Musical Note Icon] ... [Musical Note Icon]**Times** [x1...x32]

When **MIDI/Tempo Sync** is on, the LFO speed is set by **BPM**, **Base Note**, and **Times**, instead of **Frequency**. For more information, see “MIDI/Tempo Sync” on page 781.

Type [Individual, Common1, Common2]

This controls whether the effect uses its individual LFO, or one of the Common FX LFOs. For more information, see “LFO Type” on page 781.

Common LFO Phase Offset [degrees] [+/-180]

When Type is set to **Common FX LFO 1** or **2**, this lets you offset the phase from the master LFO.

OUTPUT

Wet/Dry  [-Wet...-1:99, Dry, 1: 99...Wet]

Sets the balance between the “wet” processed sound and the dry input. Negative values invert the phase of the wet signal. This interacts with **Resonance**; for more information, see “Resonance” on page 810.

052: Stereo Random Phaser

This is a stereo phaser. The effect uses a step-shape waveform and random LFO for modulation, creating a unique phasing effect.

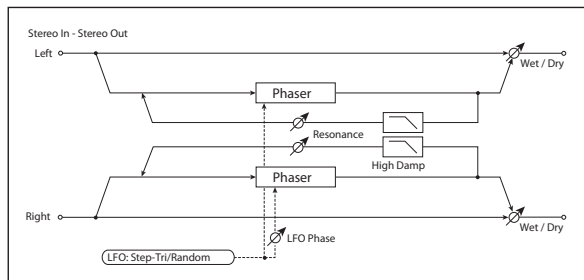

PHASER

Manual [0...100]

Sets the frequency to which the effect is applied.

Depth [0...100]

Sets the depth of LFO modulation.

Resonance [+/-100]

This controls the intensity of the phaser. For more information, see “Resonance” on page 810.

High Damp [%] [0...100]

This sets the amount of high-frequency attenuation in the phaser’s feedback loop. Increasing the value will reduce high-frequency harmonics.

LFO

Waveform [Step-Tri, Step-Sin, Random]

Selects the LFO Waveform. For more information, see “Waveform” on page 783.

Phase [degrees] [-180...+180]

Sets the LFO phase difference between the left and right. See “Phase [degrees]” on page 783.

Frequency [Hz]  [0.02...20.00]

Step Frequency [Hz]  [0.05...50.00]

Source [Off...Tempo]

Amount [-20.00...+20.00]

Step Amount [-50.00...+50.00]

These parameters control the speed of the LFO when **MIDI/Tempo Sync** is **Off**. For more information, see “Frequency” on page 783.

Source [Off...Tempo]

Selects a modulation source for Wet/Dry.

Amount [+/-100]

Sets the modulation amount for Wet/Dry.

MIDI/Tempo Sync  [Check-box]

BPM [MIDI, 40.00...300.00]

Base Note  [♩... ♪]

Times [x1...x32]

Step Note  [♩... ♪]

Times [x1...x32]

These parameters control the speed of the LFO when **MIDI/Tempo Sync** is **On**. For more information, see “Frequency” on page 783.

Type (Step) [Individual, Common1, Common2]

Common LFO Phase Offset [degrees] [+/-180]

These parameters control the LFO source for the steps; they do not affect the triangle or sine LFOs. For more information, see “Step LFO type” on page 784.

OUTPUT

Wet/Dry  [-Wet...-1:99, Dry, 1: 99...Wet]

Sets the balance between the “wet” processed sound and the dry input. Negative values invert the phase of the wet signal. This interacts with **Resonance**; for more information, see “Resonance” on page 810.

Source [Off...Tempo]

Selects a modulation source for Wet/Dry.

Amount [+/-100]

Sets the modulation amount for Wet/Dry.

053: Stereo Envelope Phaser

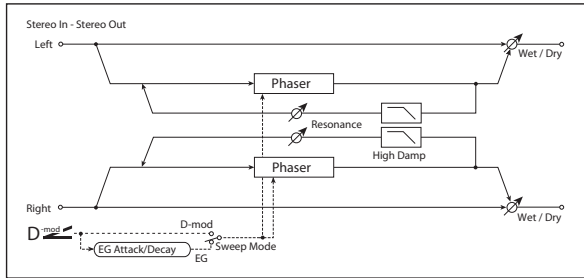

This stereo phaser uses an envelope generator for modulation. You will obtain the same pattern of phasing each time you play. You can also control the Phaser directly using the modulation source.

PHASER

L Manual Bottom [0...100]

Sets the lower limit of the left-channel phaser's sweep.

For more information on the Bottom and Top settings, see the graphic under "Frequency Bottom" on page 781.

L Manual Top [0...100]

Sets the upper limit of the left-channel phaser's sweep.

R Manual Bottom [0...100]

Sets the lower limit of the right-channel phaser's sweep.

R Manual Top [0...100]

Sets the upper limit of the right-channel phaser's sweep.

CONTROL

Sweep Mode [EG, Dmod]

Determines whether the phaser is controlled by the envelope generator or by the modulation source. For more information, see "Sweep Mode" on page 809.

Source D_{mod} [Off...Tempo]

Selects the modulation source that triggers the EG (when EG is selected for Sweep Mode), or modulation source that causes the phaser to sweep (when Dmod is selected for Sweep Mode). For more information, see "Source" on page 809.

EG

Attack [1...100]

Sets the EG attack time. For more information Attack and Release, see the graphic under "Attack [msec]" on page 766.

Decay [1...100]

Sets the EG decay time.

PHASER

Resonance [+/-100]

This controls the intensity of the phaser. For more information, see "Resonance" on page 810.

High Damp [%] [0...100]

This sets the amount of high-frequency attenuation in the phaser's feedback loop. Increasing the value will cut high-range harmonics.

OUTPUT

Wet/Dry D_{mod} [-Wet...-1:99, Dry, 1:99...Wet]

Sets the balance between the "wet" processed sound and the dry input. Negative values invert the phase of the wet signal. This interacts with **Resonance**; for more information, see "Resonance" on page 810.

Source [Off...Tempo]

Selects a modulation source for Wet/Dry.

Amount [+/-100]

Sets the modulation amount for Wet/Dry.

054: Bi Phaser

This effect provides two independent phasers that can be connected in series or in parallel.

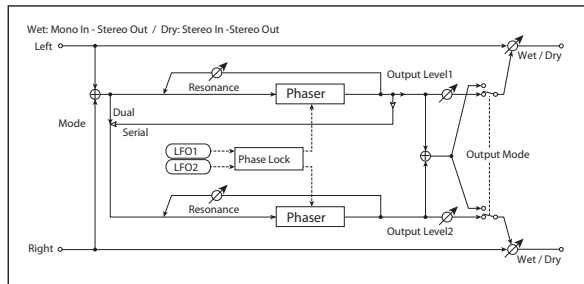

PHASER1

Manual [0...100]

Sets the frequency of phaser 1.

LFO1 Depth D_{mod} [0...100]

Sets the LFO modulation depth of phaser 1.

Source [Off...Tempo]

Selects a source to control LFO modulation depth of both phasers.

Amount [+/-100]

Sets the amount by which the phaser 1 LFO modulation depth will be controlled.

Resonance [0...100]

This controls the intensity of Phaser 1. For more information, see “Resonance” on page 810.

PHASER2

Manual [0...100]

Sets the frequency of phaser 2.

LFO2 Depth D_{mod} [0...100]

Sets the LFO modulation depth of phaser 2.

Amount [+/-100]

Sets the amount by which the phaser 2 LFO modulation depth will be controlled.

Resonance [0...100]

This controls the intensity of Phaser 1. For more information, see “Resonance” on page 810.

LFO1/2

These are the parameters for the two LFOs, which are identical to those in the Bi Chorus effect. For more information, see “LFO1/2” on page 805.

MODE

Routing [Dual, Serial]

Selects whether the phasers are connected in parallel or in series. If **Routing** is set to **Serial**, the **Phaser 1 Output Level** and **Phaser 2 Output Level** settings are ignored.

Output Mode [Mono, Stereo]

Selects whether phaser 1 and 2 will be routed separately to the left and right channels, or summed to mono.

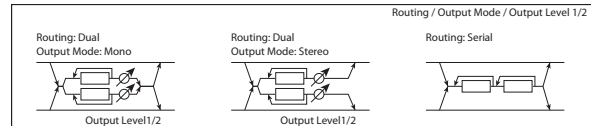

Phaser1 Output Level [0...100]

Sets the output level for phaser 1. This applies only if **Routing** is set to **Dual**.

Phaser2 Output Level [0...100]

Sets the output level for phaser 2. This applies only if **Routing** is set to **Dual**.

OUTPUT

Wet/Dry D_{wet} [-Wet...-1:99, Dry, 1: 99...Wet]

Sets the balance between the “wet” processed sound and the dry input. Negative values invert the phase of the wet signal. This interacts with **Resonance**; for more information, see “Resonance” on page 810.

Source [Off...Tempo]

Selects a modulation source for Wet/Dry.

Amount [+/-100]

Sets the modulation amount for Wet/Dry.

Modulation and Pitch Shift

055: Stereo Vibrato

This effect modulates the pitch of the input signal to create a shimmering timbre. AutoFade allows you to increase or decrease the vibrato speed.

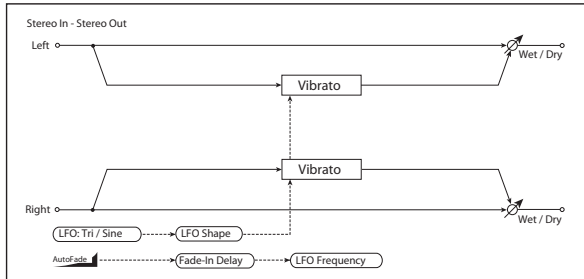

AUTOFADE

Autofade lets you modulate the LFO Frequency via a simple envelope, triggered by a Dmod source. This is enabled by setting **LFO Frequency Mod** to **AUTOFADE**, and can only be used when **BPM/Tempo Sync** is **Off**.

The intensity of the autofade's effect is controlled by the normal **Amount** parameter, under **Frequency**.

Autofade example

The diagram below shows a setup with note-ons triggering the autofade, causing the LFO to speed up from 1.0Hz to 4.0Hz.

The **AUTOFADE Source** is set to **Gate1**, **LFO Frequency Mod** is set to **AUTOFADE**, **LFO Frequency [Hz]** is set to **1.0**, and the modulation **Amount** is set to **3.0**.

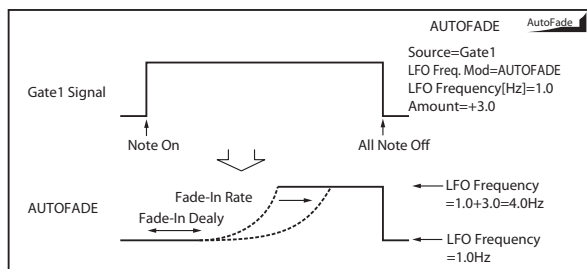

Source D^{mod} [Off...Tempo]

Selects the trigger source for the Autofade.

Autofade is triggered when the Dmod value changes from 63 or smaller to 64 or higher, and turns off again when the Dmod value goes below 64.

Rate [1...100]

Sets the speed of the fade-in. Higher values are faster.

Fade-In Delay [msec] [00...2000]

This sets the time from the trigger source turning on (going above a value of 63) until the fade-in starts.

LFO Frequency Mod [Dmod, AUTOFADE]

This selects whether the LFO will be modulated by the normal Frequency Dmod source, or by the Autofade envelope.

VIBRATO

Depth D^{mod} [0...100]

Sets the depth of LFO modulation

Source [Off...Tempo]

Selects the modulation source of the LFO modulation depth.

Amount [+/-100]

Sets the modulation amount of the LFO modulation depth.

LFO

Waveform [Triangle, Sine]

Selects the LFO Waveform.

Shape [+/-100]

Changes the curvature of the LFO Waveform. For more information, see "Shape" on page 784.

Frequency [Hz] D^{mod} [0.02...20.00]

This sets the LFO speed, in Hz. It applies only when **MIDI/Tempo Sync**, below, is **Off**.

Source [Off...Tempo]

This selects a modulation source for the **Frequency**.

Amount [-20.00...+20.00]

This sets the **Frequency** modulation amount, in Hz.

MIDI/Tempo Sync D^{mod} [Check-box]

BPM [MIDI, 40.00...300.00]

Base Note [A...G]

Times [x1...x32]

When **MIDI/Tempo Sync** is on, the LFO speed is set by **BPM**, **Base Note**, and **Times**, instead of **Frequency**. For more information, see "MIDI/Tempo Sync" on page 781.

Type [Individual, Common1, Common2]

This controls whether the effect uses its individual LFO, or one of the Common FX LFOs. For more information, see "LFO Type" on page 781.

Common LFO Phase Offset [degrees] [+/-180]

When Type is set to **Common FX LFO 1** or **2**, this lets you offset the phase from the master LFO.

OUTPUT

This is the standard effects output section, with modulatable control over wet/dry balance. For more information, see "OUTPUT" on page 764.

056: Stereo Auto Fade Mod.

This stereo chorus/flanger effect enables you to control the LFO speed and effect balance using auto fade, and you can spread the sound by offsetting the phase of the left and right LFOs from each other.

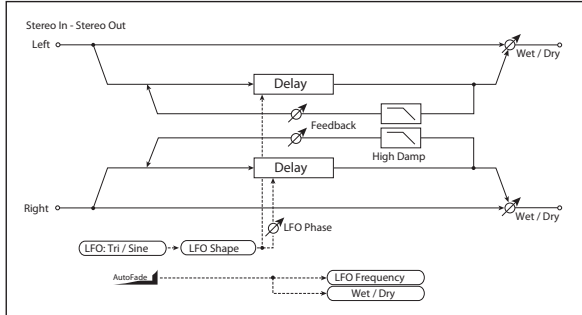

AUTOFADE

For more information on the Autofade parameters, see “AUTOFADE” on page 814.

Source **[Off...Tempo]**

Selects the modulation source that starts AutoFade.

Rate **[1...100]**

Sets the rate of fade-in.

Fade-In Delay [msec] **[00...2000]**

Sets the fade-in delay time.

LFO Frequency Mod **[Dmod, AUTOFADE]**

Switches between D-mod and AUTOFADE for the LFO frequency modulation.

Wet/Dry Mod **[Dmod, AUTOFADE]**

Switches between D-mod and AUTOFADE for the effect balance modulation.

MOD DELAY

L Delay Time [msec] **[0.0...500.0]**

Sets the left channel delay time.

R Delay Time [msec] **[0.0...500.0]**

Sets the right channel delay time.

Depth **[0...200]**

Sets the depth of LFO modulation.

Feedback **[+/-100]**

Sets the feedback amount. See “Feedback” on page 802.

High Damp [%] **[0...100]**

Sets the amount of high-frequency attenuation for the feedback path.

LFO

Waveform **[Triangle, Sine]**

Selects the LFO Waveform.

Shape **[+/-100]**

Changes the curvature of the LFO Waveform. For more information, see “Shape” on page 784.

Phase [degrees] **[-40...+40]**

Sets the LFO phase difference between the left and right. See “Phase [degrees]” on page 783.

Frequency [Hz] **[0.02...20.00]**

This sets the LFO speed, in Hz.

Source **[Off...Tempo]**

This selects a modulation source for the Frequency.

Amount **[-20.00...+20.00]**

This sets the Frequency modulation amount, in Hz.

Type **[Individual, Common1, Common2]**

This controls whether the effect uses its individual LFO, or one of the Common FX LFOs. For more information, see “LFO Type” on page 781.

Common LFO Phase Offset [degrees] **[+/-180]**

When Type is set to **Common FX LFO 1** or **2**, this lets you offset the phase from the master LFO.

OUTPUT

This is the standard effects output section, with modulatable control over wet/dry balance. For more information, see “OUTPUT” on page 764.

057: 2-Voice Resonator

This effect includes two independent resonators, which each resonate at a specified pitch in response to the input signal. You can use this to add a unique character to a string sound by emphasizing certain harmonics, for instance, or to introduce a pitched element into a drum loop. The resonance intensity can be controlled via an LFO or Dmod.

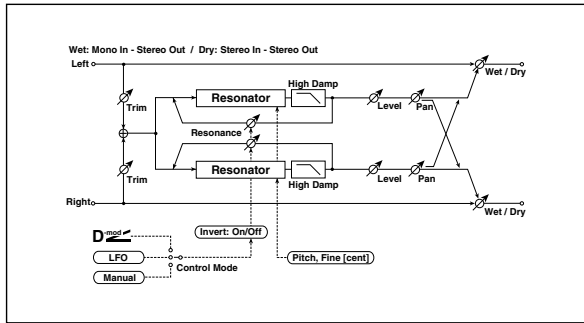

CONTROL

Trim [0...100]

This sets the input level for the effect.

Control Mode [Manual, LFO, Dmod]

This sets the way that the Resonance is controlled.

Manual: the **Resonance** parameter controls the intensity of the effect.

LFO: the intensity of resonance is controlled by the LFO. As the LFO sways between positive and negative values, the resonators alternate between octaves of the specified pitch.

Dmod: the resonance is controlled by the dynamic modulation source. If you use a bipolar modulation source, such as JS X, you can modulate the resonance so that the resonance sounds in both the high and low octaves, similar to the LFO.

LFO/Dmod Invert [Check-box]

This applies only when **Control Mode** is set to **LFO** or **Dmod**.

Enabling **LFO/Dmod Invert** reverses the **Resonance** modulation for Voice 2. As the Dmod or LFO increases, Voice 1's Resonance will be positive, but Voice 2's will be negative (and thus resonate at the lower octave).

Source [Off...Tempo]

Selects a modulation source to control **Resonance** intensity.

Modulation Depth [+/-100]

Sets the amount of resonance intensity modulation. This applies to both LFO and Dmod.

LFO

Frequency [Hz] [0.02...20.00]

This sets the LFO speed, in Hz. It applies only when **MIDI/Tempo Sync**, below, is **Off**.

MIDI/Tempo Sync [Check-box]

BPM [MIDI, 40.00...300.00]

Base Note [Musical Note]

Times [x1...x32]

When **MIDI/Tempo Sync** is on, the LFO speed is set by **BPM**, **Base Note**, and **Times**, instead of **Frequency**. For more information, see "MIDI/Tempo Sync" on page 781.

Type [Individual, Common1, Common2]

Selects either (individual) LFO, Common FX LFO1, or Common LFO2. See "LFO Type" on page 781.

Common LFO Phase Offset [degrees] [-180...+180]

Sets the phase offset when **Type** = Common 1 or Common 2. See "Common LFO Phase Offset [degrees]" on page 781.

VOICE1

Pitch [C0...B8]

This sets the tuning of Voice 1, by note name.

Fine [cents] [-50...+50]

This adjusts the fine-tuning of Voice 1, in cents.

Resonance [+/-100]

This applies only when **Control Mode** is set to **Manual**.

Negative settings change the harmonic content, and also make the resonance one octave lower.

High Damp [%] [0...100]

This sets the amount of damping for the high frequencies of the resonant sound. Lower values mean less damping, creating a metallic sound with stronger harmonics.

Level [0...100]

This sets the output level for Voice 1.

Pan [L6...L1, C, R1...R6]

This sets the stereo position of Voice 1.

VOICE2

The parameters for Voice 2 are the same as those for "VOICE1," above.

OUTPUT

This is the standard effects output section, with modulatable control over wet/dry balance. For more information, see "OUTPUT" on page 764.

058: Doppler

This effect simulates the “Doppler effect” of a moving sound with a changing pitch, like the siren of a passing ambulance. Mixing the effect sound with the dry sound will create a unique chorus effect.

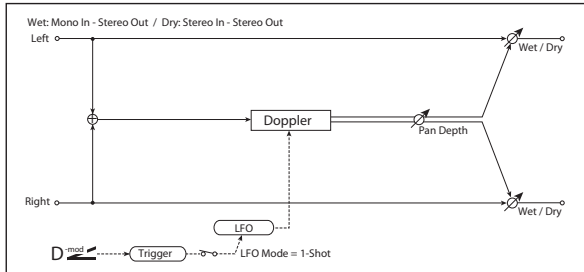

DOPPLER

Pitch Depth D_{mod} [0...100]

With the Doppler effect, the pitch is raised as the sound approaches, and the pitch is lowered as the sound goes away. This parameter controls the amount of this pitch variation.

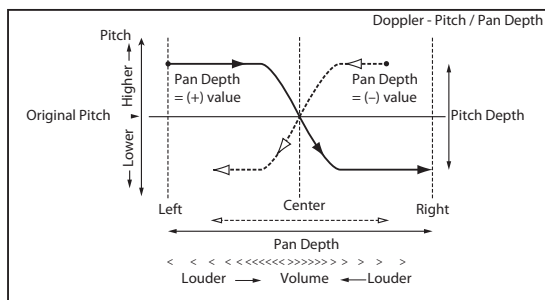

Source [Off...Tempo]

Selects the modulation source of pitch variation.

Amount [+/-100]

Sets the modulation amount of pitch variation.

Pan Depth D_{mod} [+/-100]

This sets the width of the stereo image of the effect sound. With larger values, the sound seems to come and go from much further away. With positive values, the sound moves from left to right; with negative values, it moves from right to left.

Source [Off...Tempo]

Selects the modulation source of panning.

Amount [+/-100]

Sets the modulation amount of panning.

LFO

Mode [Loop, 1-Shot]

This selects whether the Doppler effect repeats continuously (**Loop**), or cycles once and then stops (**1-Shot**).

When **Mode** is set to **Loop**, and **Dmod Sync** is set to **On**, you can reset the LFO via Dmod (as specified by the **Source** parameter, below).

When **Mode** is set to **1-Shot**, the Doppler effect happens only once when triggered, and then stops until it is triggered again. The trigger source is specified by the **Source** parameter, below. Note that this requires you to manually trigger the effect; otherwise, you won't hear the Doppler at all.

Dmod Sync [Check-box]

When this is **On**, and **Mode** is set to **Loop**, you can reset the LFO via Dmod (as specified by the **Source** parameter, below).

Source D_{mod} [Off...Tempo]

Selects the LFO reset modulation source.

MIDI The effect is triggered when the MIDI value changes from 63 or smaller to 64 or higher.

Frequency [Hz] D_{mod} [0.02...20.00]

This sets the LFO speed, in Hz. It applies only when **MIDI/Tempo Sync**, below, is **Off**.

Source [Off...Tempo]

This selects a modulation source for the **Frequency**.

Amount [-20.00...+20.00]

This sets the **Frequency** modulation amount, in Hz.

MIDI/Tempo Sync D_{mod} [Check-box]

BPM [MIDI, 40.00...300.00]

Base Note [J...o]

Times [x1...x32]

When **MIDI/Tempo Sync** is on, the LFO speed is set by **BPM**, **Base Note**, and **Times**, instead of **Frequency**. For more information, see “MIDI/Tempo Sync” on page 781.

Type [Individual, Common1, Common2]

This controls whether the effect uses its individual LFO, or one of the Common FX LFOs. For more information, see “LFO Type” on page 781.

Common LFO Phase Offset [degrees] [+/-180]

When **Type** is set to **Common FX LFO 1** or **2**, this lets you offset the phase from the master LFO.

OUTPUT

This is the standard effects output section, with modulatable control over wet/dry balance. For more information, see “OUTPUT” on page 764.

059: Scratch

This effect simulates the sound of scratching on a turntable, by recording the input and then modulating the playback.

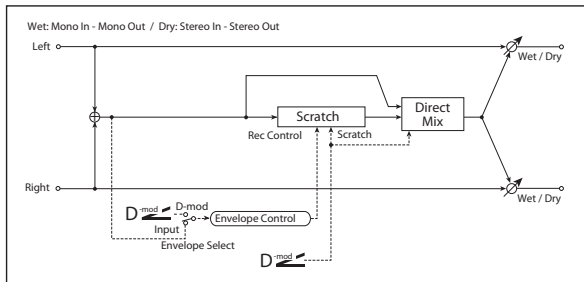

RECORD

Envelope Select [Dmod, Input]

Selects whether the start and end of recording is controlled via the modulation source or the input signal level.

Dmod: the input signal will be recorded only when the modulation value is 64 or higher.

Input: the input signal will be recorded only when its level is over the **Threshold** value.

The maximum recording time is 2,730msec. If this is exceeded, the recorded data will start being erased from the top.

Source [Dmod] [Off...Tempo]

Selects the modulation source that controls recording when **Envelope Select** is set to **Dmod**.

Threshold [0...100]

Sets the recording start level when **Envelope Select** is set to **Input**.

Response [0...100]

This sets the speed of the response to the end of recording. Set a smaller value when you are recording a phrase or rhythm pattern, and set a higher value if you are recording only one note.

PLAYBACK

Scratch Source [Dmod] [Off...Tempo]

This selects the modulation source for the “scratch.” The modulation value corresponds to the playback position.

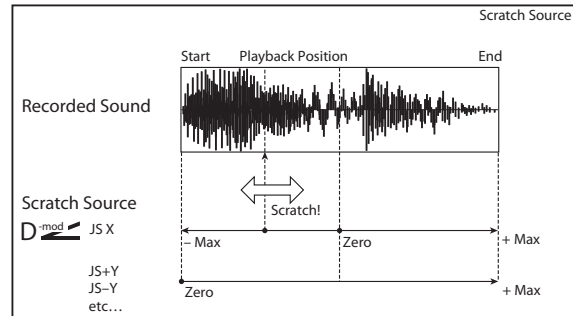

Response [0...100]

This controls how fast the effect responds to the **Scratch Source**.

Direct Mix [Always On, Always Off, Cross Fade]

This controls how the dry sound is mixed with the effected sound. To use this parameter effectively, set **Wet/Dry** to **Wet**.

Always On: The dry sound is always heard at the output, and the scratch effect is layered on top.

Always Off: Only the scratch effect is heard at the output. If you're not scratching, there won't be any sound.

Cross Fade: Normally, the dry sound is heard at the output. When you start to scratch, the dry sound is muted; when you stop scratching, the dry sound reappears.

OUTPUT

This is the standard effects output section, with modulatable control over wet/dry balance. For more information, see “OUTPUT” on page 764.

060: Grain Shifter

This effect cuts extremely short samples (“grains”) from the input signal waveform and plays them repeatedly, giving a mechanical character to the sound.

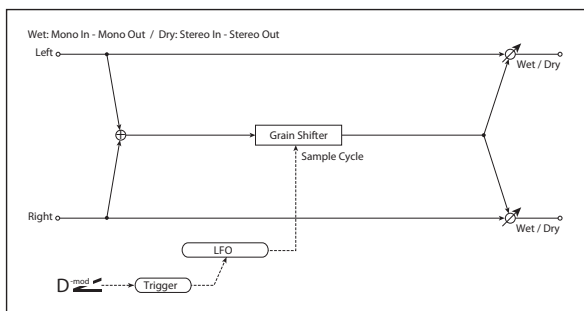

GRAIN SHIFTER

Duration [Dmod] [0...100]

Duration sets the length of the sampled grain, and the **LFO Sample Cycle** controls how often a new grain is sampled. In between Sample Cycles, the current grain is repeated continuously.

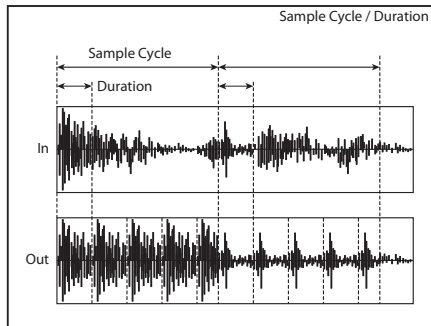

Source [Off...Tempo]

Selects the source that will modulate the duration of the grain.

Amount [+/-100]

Sets the amount by which the grain duration will be modulated.

LFO

Sync Source [Off...Tempo]

Selects the modulation source that will reset the LFO.

Sample Cycle [Hz] [0.02...20.00]

Sets the frequency at which the grain will be switched. For more information, see "Duration," above.

Source [Off...Tempo]

Selects a modulation source for LFO speed.

Amount [-20.00...+20.00]

Sets the modulation amount of LFO speed.

MIDI/Tempo Sync [Check-box]

BPM [MIDI, 40.00...300.00]

Base Note [Musical Notation]

Times [x1...x32]

When **MIDI/Tempo Sync** is on, the LFO speed is set by **BPM**, **Base Note**, and **Times**, instead of **Frequency**. For more information, see "MIDI/Tempo Sync" on page 781.

Type [Individual, Common1, Common2]

This controls whether the effect uses its individual LFO, or one of the Common FX LFOs. For more information, see "LFO Type" on page 781.

Common LFO Phase Offset [degrees] [+/-180]

When **Type** is set to **Common FX LFO 1** or **2**, this lets you offset the phase from the master LFO.

OUTPUT

This is the standard effects output section, with modulatable control over wet/dry balance. For more information, see "OUTPUT" on page 764.

061: Stereo Tremolo

This effect modulates the volume level of the input signal. The effect is stereo, and offsetting the LFO of the left and right phases from each other produces a tremolo effect between left and right.

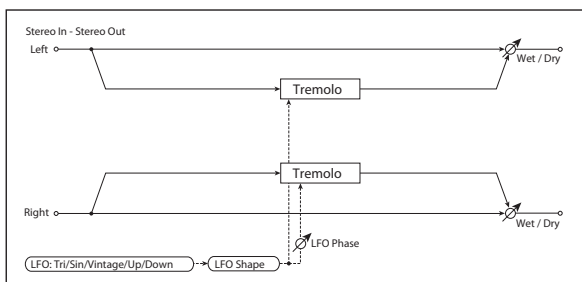

TREMOLO

Depth [0...100]

Sets the depth of LFO modulation.

Source [Off...Tempo]

Selects the modulation source of the depth of modulation.

Amount [+/-100]

Sets the modulation amount of the depth of modulation.

LFO

Waveform [Triangle, Sine, Vintage, Up, Down]

This parameter sets the basic shape of the LFO. The **Vintage** waveform models classic guitar-amp tremolo.

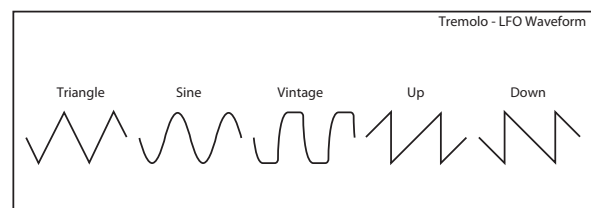

Shape [+/-100]

Changes the curvature of the LFO Waveform. p.784.

Phase [degrees] [-180...+180]

This parameter determines the difference between the left and right LFO phases. Higher values create an auto-pan effect, the sound moving between left and right.

Frequency [Hz] [0.02...20.00]

This sets the LFO speed, in Hz. It applies only when **MIDI/Tempo Sync**, below, is **Off**.

Source [Off...Tempo]

This selects a modulation source for the **Frequency**.

Amount [-20.00...+20.00]

This sets the **Frequency** modulation amount, in Hz.

MIDI/Tempo Sync D_{mod} [Check-box]

BPM [MIDI, 40.00...300.00]

Base Note [♪ ... ♯]

Times [x1...x32]

When **MIDI/Tempo Sync** is on, the LFO speed is set by **BPM**, **Base Note**, and **Times**, instead of **Frequency**. For more information, see “MIDI/Tempo Sync” on page 781.

Type [Individual, Common1, Common2]

This controls whether the effect uses its individual LFO, or one of the Common FX LFOs. For more information, see “LFO Type” on page 781.

Common LFO Phase Offset [degrees] [+/-180]

When Type is set to **Common FX LFO 1** or **2**, this lets you offset the phase from the master LFO.

OUTPUT

This is the standard effects output section, with modulatable control over wet/dry balance. For more information, see “OUTPUT” on page 764.

062: Stereo Envelope Tremolo

This effect uses the input signal level to modulate a stereo tremolo (LFO volume modulation). For instance, you can create a tremolo effect that becomes deeper and faster as the input gets more quiet.

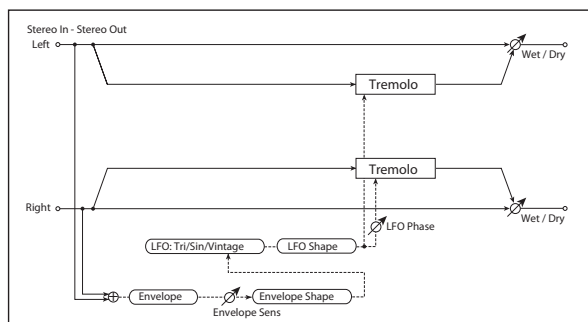

ENVELOPE

Sensitivity [0...100]

Sets the envelope’s sensitivity to the input signal.

Shape [+/-100]

Sets the envelope’s curvature.

TREMOLO

Depth [0...100]

Sets the initial amount of tremolo.

Envelope Amount [+/-100]

Sets the amount added to or subtracted from the Depth when the envelope is at maximum.

Modulation Example

The graphic below shows an example of tremolo modulation with negative modulation of both **Depth** and **Frequency**. At the start of the note, the input is at maximum volume. This slows down the LFO **Frequency** to **1.0Hz**, but also modulates the **Depth** to **0**—so the tremolo doesn’t have any effect.

As the input volume dies down, the **Frequency** speeds up; the **Depth** also increases, making the tremolo effect increasingly audible. When the input volume approaches silence, the **Depth** is at its maximum (**100**) and **Frequency** is at **8Hz**.

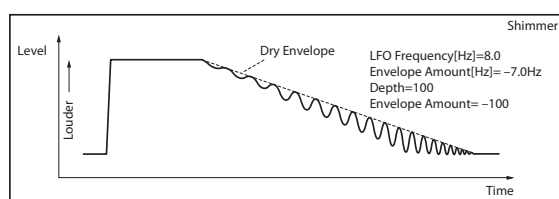

LFO

Waveform [Triangle, Sine, Vintage]

Selects the LFO Waveform.

Shape [+/-100]

Changes the curvature of the LFO Waveform. p.784.

Phase [degrees] [-180...+180]

Sets the LFO phase difference between the left and right. p.819.

Frequency [Hz] [0.02...20.00]

Sets initial speed of the LFO. p.820.

Envelope Amount [Hz] [-20.00...+20.00]

Sets the amount added to or subtracted from the Frequency when the envelope is at maximum. p.820.

OUTPUT

This is the standard effects output section, with modulatable control over wet/dry balance. For more information, see “OUTPUT” on page 764.

063: Stereo Auto Pan

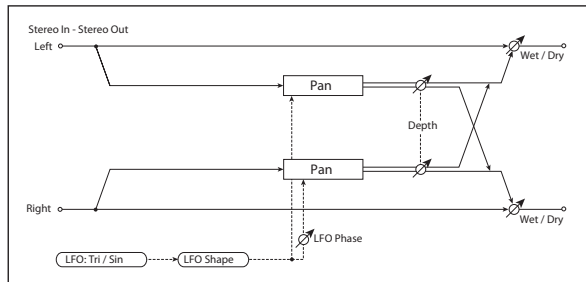

This is a stereo-in, stereo-out auto-panner. The Phase and Shape parameters lets you create various panning effects, such as making the left and right inputs seem to chase each other around the stereo field.

AUTO PAN

Depth [0...100]

Sets the depth of LFO modulation.

Source [Off...Tempo]

Selects the modulation source of the depth of modulation.

Amount [+/-100]

Sets the modulation amount of the depth of modulation.

LFO

Waveform [Triangle, Sine]

Selects the LFO Waveform.

Shape [+/-100]

This changes the curvature of the LFO Waveform, which controls the way that the audio moves around the stereo field.

Phase [degrees] [-180...+180]

This determines the phase difference between the left and right LFOs. When you gradually change the value away from 0, the sounds from the left and right channels will seem to chase each other around. If you set the parameter to +180 or -180, the sounds from each channel will cross over each other.

You'll only hear the effect of this parameter if the input is true stereo, with different signals in the left and right channels.

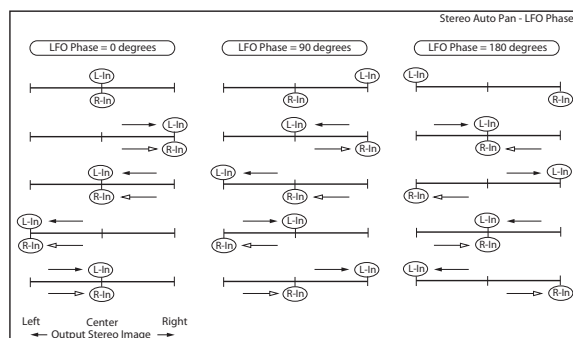

Frequency [Hz] [0.02...20.00]

This sets the LFO speed, in Hz. It applies only when **MIDI/Tempo Sync**, below, is **Off**.

Source [Off...Tempo]

This selects a modulation source for the **Frequency**.

Amount [-20.00...+20.00]

This sets the **Frequency** modulation amount, in Hz.

MIDI/Tempo Sync [Check-box]

BPM [MIDI, 40.00...300.00]

Base Note [♩...♩]

Times [x1...x32]

When **MIDI/Tempo Sync** is on, the LFO speed is set by **BPM**, **Base Note**, and **Times**, instead of **Frequency**. For more information, see "MIDI/Tempo Sync" on page 781.

Type [Individual, Common1, Common2]

This controls whether the effect uses its individual LFO, or one of the Common FX LFOs. For more information, see "LFO Type" on page 781.

Common LFO Phase Offset [degrees] [+/-180]

When **Type** is set to **Common FX LFO 1** or **2**, this lets you offset the phase from the master LFO.

OUTPUT

This is the standard effects output section, with modulatable control over wet/dry balance. For more information, see "OUTPUT" on page 764.

064: Stereo Phaser+Tremolo

This effect combines a stereo phaser and tremolo, with linked LFOs. Swelling phaser modulation and tremolo effects synchronize with each other, creating a soothing modulation effect particularly suitable for electric piano.

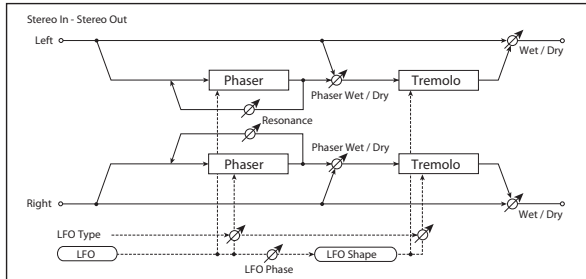

PHASER

Manual [0...100]

Sets the phaser frequency range.

Depth [0...100]

Sets the phaser modulation depth.

Source [Off...Tempo]

Selects the modulation source for the phaser modulation depth.

Amount [+/-100]

Sets the modulation amount for the phaser modulation depth.

Resonance [+/-100]

Sets the phaser resonance amount.

Wet/Dry [-Wet, -2:98...Dry...2:98, Wet]

Sets the balance between the phaser effect and the dry sound, feeding into the tremolo. Values are in steps of two (2:98, 4:96 etc). Note that the OUTPUT section's **Wet/Dry** parameter controls the overall wet/dry balance.

TREMOLO

Shape [+/-100]

Sets the degree of the tremolo LFO shaping. p.784.

Depth [0...100]

Sets the tremolo modulation depth.

Source [Off...Tempo]

Selects the modulation source for the tremolo modulation depth.

Amount [+/-100]

Sets the modulation amount of the tremolo modulation depth.

LFO

L/R Phase Type

[Phaser - Tremolo, Phaser - Tremolo Spin, Phaser LR - Tremolo, Phaser LR - Tremolo Spin, Phaser LR - Tremolo LR]

The phaser and the tremolo are both stereo, and each has its own stereo LFO. This parameter controls the stereo phase relationships of the LFOs within the individual effects.

There are two options for the Phaser, and three options for the Tremolo, as described below. The menu selections set both simultaneously.

Phaser: the phaser's left and right LFOs are in phase with one another.

Phaser LR: the phaser's left and right LFOs are 180 degrees out of phase, enhancing the stereo effect.

Tremolo: the tremolo's left and right LFOs are in phase with one another, causing simple amplitude modulation without stereo panning.

Tremolo Spin: the tremolo's left and right LFOs are offset, causing the sound to appear to spin around the listener.

Tremolo LR: the tremolo's left and right LFOs are 180 degrees out of phase, causing the signal to pan between the left and right channels.

Phaser/Tremolo Phase [degrees] [-180, -90, 0, +90, +180]

This lets you offset the phase between the phaser's LFOs and the tremolo's LFOs. The result is that the peaks of the phaser and the amplitude modulation or panning of the tremolo will overlap in different ways, altering the sensations of movement and rotation in the sound.

Frequency [Hz] [0.02...20.00]

This sets the LFO speed, in Hz. It applies only when **MIDI/Tempo Sync**, below, is **Off**.

Source [Off...Tempo]

This selects a modulation source for the **Frequency**.

Amount [-20.00...+20.00]

This sets the **Frequency** modulation amount, in Hz.

MIDI/Tempo Sync [Check-box]

BPM [MIDI, 40.00...300.00]

Base Note []

Times [x1...x32]

When **MIDI/Tempo Sync** is on, the LFO speed is set by **BPM**, **Base Note**, and **Times**, instead of **Frequency**. For more information, see "MIDI/Tempo Sync" on page 781.

Type [Individual, Common1, Common2]

This controls whether the effect uses its individual LFO, or one of the Common FX LFOs. For more information, see "LFO Type" on page 781.

Common LFO Phase Offset [degrees] [+/-180]

When Type is set to **Common FX LFO 1** or **2**, this lets you offset the phase from the master LFO.

OUTPUT

This is the standard effects output section, with modulatable control over wet/dry balance. For more information, see “OUTPUT” on page 764.

065: Stereo Ring Modulator

This effect creates a metallic sound by applying the oscillators to the input signal. Use the LFO or Dynamic Modulation to modulate the oscillator to create a radical modulation. Matching the oscillator frequency with a note number will produce a ring modulation effect in specific key ranges.

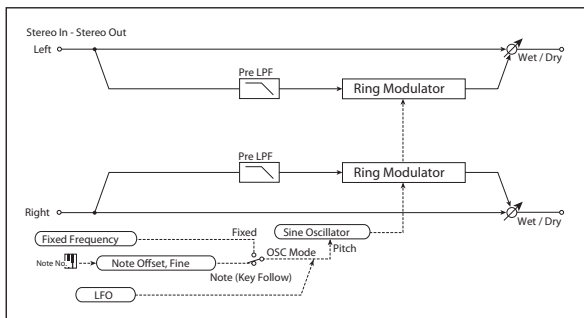

RING MODULATOR

Pre LPF [0...100]

If the input is very bright, the ring modulator may sound harsh or noisy. If this occurs, you can smooth out the effect by increasing the **Pre LPF** (Low Pass Filter) setting, to cut out some of the input’s high frequencies. The higher the setting, the more the high frequencies will be cut.

OSC Mode [Fixed, Note (Key Follow)]

This determines whether the oscillator frequency follows the note number, or stays at a fixed value.

Note (Key Follow): The oscillator’s frequency is based on MIDI note number (on the effect’s MIDI channel), allowing you to use it as an octaver. The **Note Interval** parameter, below, sets the pitch offset from the original note, in semitones. Matching the oscillator frequency with the note number produces a more gentle ring modulation effect, in the correct key.

Fixed: the oscillator uses the manually-set **Fixed Frequency**, below.

Fixed Frequency [Hz] [0...12.00k]

This controls the oscillator frequency when **OSC Mode** is set to **Fixed**.

Source [Off...Tempo]

Selects the modulation source for the oscillator frequency when **OSC Mode** is set to **Fixed**.

Amount [-12.00k...+12.00k]

Sets the oscillator frequency modulation amount when **OSC Mode** is set to **Fixed**.

Note Offset [-48...+48]

This sets a pitch offset from the received MIDI note number, in semitones. It applies only when **OSC Mode** is set to **Note (Key Follow)**.

Try using offsets of octaves (+/-12, 24, etc.) or fifths (+7, +19, -5, etc.).

Note Fine [+/-100]

This adjusts the frequency in cents (1/100 of a semitone). It applies only when **OSC Mode** is set to **Note (Key Follow)**.

LFO Depth [0...100]

Sets the depth of LFO modulation for the oscillator frequency.

Source [Off...Tempo]

Selects the modulation source of the depth of modulation.

Amount [+/-100]

Sets the modulation amount of the depth of modulation.

LFO

Frequency [Hz] [0.02...20.00]

This sets the LFO speed, in Hz. It applies only when **MIDI/Tempo Sync**, below, is **Off**.

Source [Off...Tempo]

This selects a modulation source for the **Frequency**.

Amount [-20.00...+20.00]

This sets the **Frequency** modulation amount, in Hz.

MIDI/Tempo Sync [Check-box]

BPM [MIDI, 40.00...300.00]

Base Note [Musical Note]

Times [x1...x32]

When **MIDI/Tempo Sync** is on, the LFO speed is set by **BPM**, **Base Note**, and **Times**, instead of **Frequency**. For more information, see “MIDI/Tempo Sync” on page 781.

Type [Individual, Common1, Common2]

This controls whether the effect uses its individual LFO, or one of the Common FX LFOs. For more information, see “LFO Type” on page 781.

Common LFO Phase Offset [degrees] [+/-180]

When Type is set to **Common FX LFO 1** or **2**, this lets you offset the phase from the master LFO.

OUTPUT

This is the standard effects output section, with modulatable control over wet/dry balance. For more information, see “OUTPUT” on page 764.

066: Stereo Frequency Shifter

This is a stereo effect that shifts the frequency of the input signal. You can use LFO modulation and delay to produce a wide range of pitch-change effects.

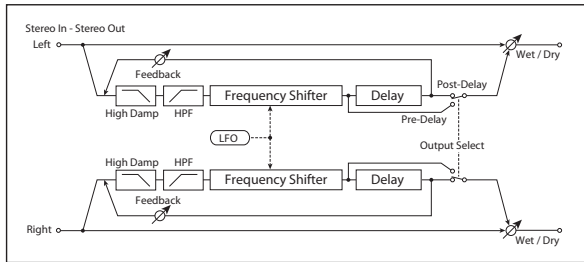

FREQUENCY SHIFTER

High Damp [%] [0...99]

Sets the high-frequency attenuation of the delayed sound.

HPF Fc [Hz] [20...11.90k]

Sets the cutoff frequency for the high pass filter.

Frequency Shift [Hz] D_{mod} [-6.00k...+6.00k]

Sets the amount of frequency shift.

Source [Off...Tempo]

Selects the modulation source that will control frequency shift.

Amount [-6.00k...+6.00k]

Sets the modulation amount for controlling frequency shift.

LFO Depth [Hz] D_{mod} [-6.00k...+6.00k]

Sets the depth by which the LFO will modulate the frequency shift.

Source [Off...Tempo]

Selects the modulation source that will control LFO modulation of frequency shift.

Amount [-6.00k...+6.00k]

Sets the amount by which the modulation source will control LFO modulation of the frequency shift.

LFO

Frequency [Hz] D_{mod} [0.02...20.00]

This sets the LFO speed, in Hz. It applies only when **MIDI/Tempo Sync**, below, is **Off**.

Source [Off...Tempo]

This selects a modulation source for the **Frequency**.

Amount [-20.00...+20.00]

This sets the **Frequency** modulation amount, in Hz.

MIDI/Tempo Sync D_{mod} [Check-box]

BPM [MIDI, 40.00...300.00]

Base Note [♪...o]

Times [x1...x32]

When **MIDI/Tempo Sync** is on, the LFO speed is set by **BPM**, **Base Note**, and **Times**, instead of **Frequency**. For more information, see “MIDI/Tempo Sync” on page 781.

Type [Individual, Common1, Common2]

This controls whether the effect uses its individual LFO, or one of the Common FX LFOs. For more information, see “LFO Type” on page 781.

Common LFO Phase Offset [degrees] [+/-180]

When Type is set to **Common FX LFO 1** or **2**, this lets you offset the phase from the master LFO.

DELAY

Delay Time [msec] [0.0...2730.0]

Sets the delay time.

Feedback D_{mod} [+/-100]

Sets the feedback amount.

Source [Off...Tempo]

Selects the modulation source of feedback amount.

Amount [+/-100]

Sets the depth by which feedback amount will be modulated.

Output Select [pre-delay, post-delay]

Selects whether the pre-delay or the post-delay sound will be output.

OUTPUT

This is the standard effects output section, with modulatable control over wet/dry balance. For more information, see “OUTPUT” on page 764.

067: Detune

This effect offsets the pitch slightly from the input signal. Compared to a chorus, this can be used to create a more subtle thickening effect,

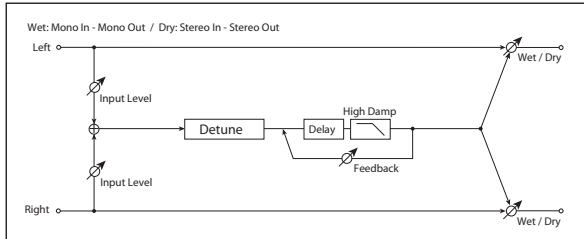

INPUT

Input Level Dmod [%] **[+/-100]**

Sets the modulation amount for the input level.

Source **[Off...Tempo]**

Selects the modulation source for the input level.

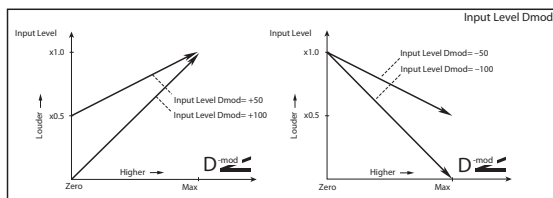

PITCH SHIFTER

Pitch Shift [cents] **[+/-100]**

Sets the pitch difference from the input signal.

Source **[Off...Tempo]**

Selects a modulation source for pitch shift.

Amount **[+/-100]**

Sets the modulation amount for pitch shift.

DELAY

Delay Time [msec] **[0...1000]**

Sets the delay time.

Feedback **[+/-100]**

Sets the feedback amount.

High Damp [%] **[0...100]**

Sets the amount of high-frequency attenuation for the feedback path.

OUTPUT

This is the standard effects output section, with modulatable control over wet/dry balance. For more information, see “OUTPUT” on page 764.

068: Pitch Shifter

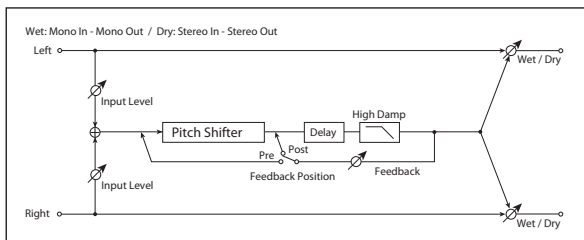

This effect changes the pitch of the input signal. The built-in 2-second delay can be fed back through the pitch shifter, for classic, spiraling effects.

INPUT

Input Level Dmod [%] **[+/-100]**

Sets the modulation amount of the input level. See “Input Level Dmod [%]” on page 825.

Source **[Off...Tempo]**

Selects the modulation source for the input level.

PITCH SHIFTER

Mode **[Slow, Medium, Fast]**

This controls the basic operation of the pitch shifter.

Slow preserves the tonal quality of the input, but adds a fixed amount of delay. This generally works best with moderate **Pitch Shift** settings.

Fast provides a quick response time, but may change the tone. This generally works best with extreme **Pitch Shift** settings.

Medium is in-between these two.

Pitch Shift [1/2 steps] **[-24...+24]**

This sets the basic amount of pitch shifting, in semitones. You can also make precise adjustments using **Fine [cents]**, below.

Fine [cents] **[+/-100]**

This adjusts the pitch shift in cents (1/100 of a semitone).

Source **[Off...Tempo]**

This selects the modulation source for **Pitch Shift**. As with **Pitch Shift** itself, you can set the amount of modulation in both semitones and cents.

Pitch Shift Amount **[-24...+24]**

This sets the basic amount of modulation, in semitones. You can also make precise adjustments using **Fine Amount**, below.

Fine Amount **[+/-100]**

This adjusts the amount of modulation in cents (1/100 of a semitone).

DELAY

Delay Time [msec] [0...2000]

Sets the delay time.

Feedback Position [Pre, Post]

Pre feeds the delay back through the pitch shifter. Each time the feedback repeats, the pitch will get increasingly lower or higher.

Post means that the feedback does not go through the pitch shifter, so that the pitch stays the same through successive repeats.

Feedback [+/-100]

Sets the feedback amount.

High Damp [%] [0...100]

Sets the amount of high-frequency attenuation for the feedback path.

OUTPUT

This is the standard effects output section, with modulatable control over wet/dry balance. For more information, see “OUTPUT” on page 764.

069: Stereo Pitch Shifter

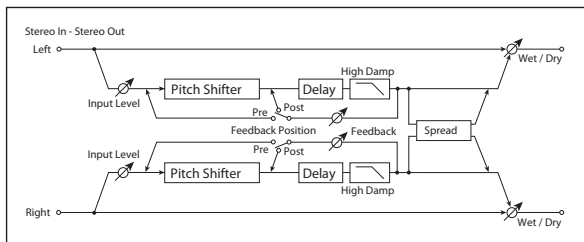

This is a stereo pitch shifter. The pitch shift amount for the left and right channels can be reversed from each other.

INPUT

Input Level Dmod [%] [+/-100]

Sets the modulation amount of the input level. See “Input Level Dmod [%]” on page 825.

Source [Off...Tempo]

Selects the modulation source for the input level.

Source [Off...Tempo]

This selects the modulation source for **Pitch Shift**. As with **Pitch Shift** itself, you can set the amount of modulation in both semitones and cents.

Pitch Shift Amount [-24...+24]

This sets the basic amount of modulation, in semitones. You can also make precise adjustments using **Fine Amount**, below.

Fine Amount [+/-100]

This adjusts the amount of modulation in cents (1/100 of a semitone).

PITCH SHIFTER

Mode [Slow, Medium, Fast]

This controls whether the pitch shift will preserve tonal quality but have a longer delay time (**Slow**), or be fast but with lower quality (**Fast**). For details, see “Mode” on page 825.

L/R Pitch [Normal, Up/Down]

Determines whether or not the L/R pitch shift amount is inverted.

Normal: The pitches of the left and right channels shift together.

Up/Down: the pitch shift amount for the right channel will be reversed. If the pitch shift amount is positive, the pitch of the left channel is raised, and the pitch of the right channel is lowered.

Pitch Shift [1/2 steps] [-24...+24]

This sets the basic amount of pitch shifting, in semitones. You can also make precise adjustments using **Fine [cents]**, below.

Fine [cents] [+/-100]

This adjusts the pitch shift in cents (1/100 of a semitone).

DELAY

L Delay Time [msec] [0...2000]

Sets the delay time for the left channel.

R Delay Time [msec] [0...2000]

Sets the delay time for the right channel.

Feedback Position [Pre, Post]

Pre feeds the delay back through the pitch shifter. Each time the feedback repeats, the pitch will get increasingly lower or higher.

Post means that the feedback does not go through the pitch shifter, so that the pitch stays the same through successive repeats.

Feedback [+/-100]

Sets the feedback amount.

High Damp [%] [0...100]

Sets the amount of high-frequency attenuation for the feedback path.

Spread [+/-100]

Sets the width of the stereo image of the effect sound. See “Spread” on page 835.

OUTPUT

This is the standard effects output section, with modulatable control over wet/dry balance. For more information, see “OUTPUT” on page 764.

070: Pitch Shifter BPM

This pitch shifter enables you to set the delay time to match the song tempo.

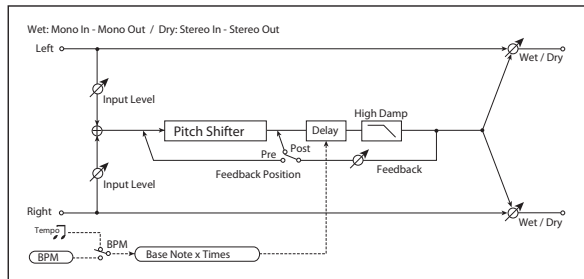

INPUT

Input Level Dmod [%] **[+/-100]**

Sets the modulation amount of the input level. See “Input Level Dmod [%]” on page 825.

Source **[Off...Tempo]**

Selects the modulation source for the input level.

PITCH SHIFTER

Mode **[Slow, Medium, Fast]**

This controls whether the pitch shift will preserve tonal quality but have a longer delay time (**Slow**), or be fast but with lower quality (**Fast**). For details, see “Mode” on page 825.

Pitch Shift [1/2 steps] **[-24...+24]**

Sets the pitch shift amount in steps of a semitone. p.825

Fine [cents] **[+/-100]**

Sets the pitch shift amount in steps of one cent. p.825

Source **[Off...Tempo]**

Selects the modulation source for both **Pitch Shift** and **Fine**.

Pitch Shift Amount **[-24...+24]**

Sets the modulation amount for **Pitch Shift**.

Fine Amount **[+/-100]**

Sets the modulation amount for **Fine**.

DELAY

BPM **[MIDI, 40.00...300.00]**

MIDI syncs to the system tempo; 40-240 sets the tempo manually for this individual effect.

Time Over?> **[---, OVER!]**

The maximum delay time is 2,000msec. If the channel’s combination of **BPM**, **Base Note**, and **Times** exceeds this limit, the error message “OVER!” will appear. If this occurs, change the delay time parameters so that this message no longer appears.

Base Note **[♪...]**

This sets the basic delay length, relative to the **BPM** setting. The values range from a 32nd note to a whole note, including triplets.

Times **[x1...x32]**

This multiplies the length of the **Base Note**. For instance, if the **Base Note** is set to a sixteenth note, and **Times** is set to 3, result will be a dotted eighth note.

Feedback Position **[Pre, Post]**

Switches the feedback connection. p.826.

Feedback **[+/-100]**

Sets the feedback amount. p.826.

High Damp [%] **[0...100]**

Sets the amount of high-frequency attenuation for the feedback path.

OUTPUT

This is the standard effects output section, with modulatable control over wet/dry balance. For more information, see “OUTPUT” on page 764.

071: Stereo Pitch Shifter BPM

This stereo pitch shifter enables you to set the delay time to match the song tempo.

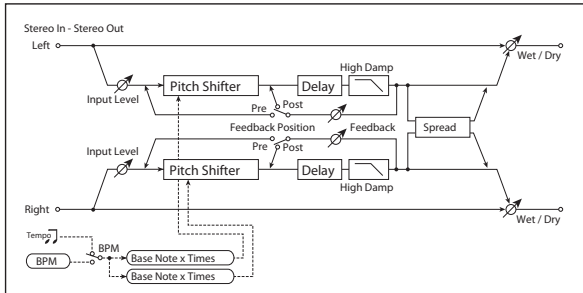

INPUT

Input Level Dmod [%] [+/-100]

Sets the modulation amount of the input level. p.825.

Source [Off...Tempo]

Selects the modulation source for the input level. p.825.

PITCH SHIFTER

Mode [Slow, Medium, Fast]

Switches Pitch Shifter mode. p.825.

L/R Pitch [Normal, Up/Down]

Determines whether or not the L/R pitch shift amount is inverted. p.826.

Pitch Shift [1/2 steps] [-24...+24]

Sets the pitch shift amount in steps of a semitone. p.825

Fine [cents] [+/-100]

Sets the pitch shift amount in steps of one cent. p.825

Source [Off...Tempo]

Selects the modulation source of pitch shift amount. p.825.

Pitch Shift Amount [-24...+24]

Sets the modulation amount of pitch shift amount. p.825.

Fine Amount [+/-100]

Sets the modulation amount of pitch shift amount Sets the modulation amount of pitch shift amount. p.825.

DELAY

BPM [MIDI, 40.00...300.00]

MIDI syncs to the system tempo; 40-240 sets the tempo manually for this individual effect. p.827.

Time Over? L > [---, OVER!]

Display the error message if the left channel delay time exceeds the upper limit. p.827.

Time Over? R > [---, OVER!]

Display the error message if the right channel delay time exceeds the upper limit. p.827.

L Base Note [Musical Note Icon]

Selects the type of notes to specify the left channel delay time. p.827.

Times [x1...x32]

Sets the number of notes to specify the left channel delay time. p.827.

R Base Note [Musical Note Icon]

Selects the type of notes to specify the right channel delay time. p.827.

Times [x1...x32]

Sets the number of notes to specify the right channel delay time. p.827.

Feedback Position [Pre, Post]

Switches the feedback connection. p.826.

Feedback [+/-100]

Sets the feedback amount. p.826.

High Damp [%] [0...100]

Sets the amount of high-frequency attenuation for the feedback path.

Spread [+/-100]

Sets the width of the stereo image of the effect sound.

OUTPUT

This is the standard effects output section, with modulatable control over wet/dry balance. For more information, see "OUTPUT" on page 764.

072: Pitch Shift Mod.

This effect uses an LFO to modulate the pitch shift amount, and lets you adjust the panning and stereo width between the effected and dry sounds.

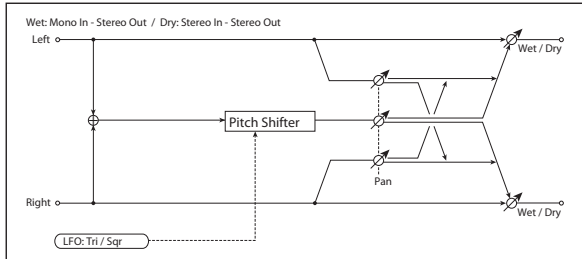

PITCH SHIFTER

Pitch Shift [cents] [+/-100]

Sets the pitch difference from the input signal.

Depth [+/-100]

Sets the LFO modulation depth for pitch shift amount.

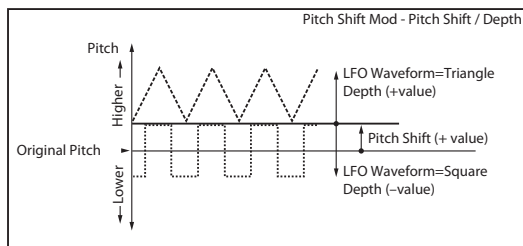

Source [Off...Tempo]

Selects the modulation source of the depth of modulation.

Amount [+/-100]

Sets the modulation amount of the depth of modulation.

Pan [L, 1:99...99:1, R]

This simultaneously controls the panning and stereo width for the pitch-shifted and dry sounds. The value is shown for the pitch-shifted signal, and the dry signal is always at the opposite side of the stereo field.

For instance, when **Pan** is set to L, the effected sound is panned all the way to the left, and the dry sound is panned all the way to the right. When **Pan** is set to R, the panning is reversed.

Intermediate values decrease the stereo width, so that at 50:50, both sounds are centered.

LFO

Waveform [Triangle, Square]

Selects the LFO Waveform.

Frequency [Hz] [0.02...20.00]

Sets the LFO speed, in Hz.

Source [Off...Tempo]

Selects a modulation source for LFO speed.

Amount [-20.00...+20.00]

Sets the modulation amount of LFO speed.

MIDI/Tempo Sync [Check-box]

BPM [MIDI, 40.00...300.00]

Base Note [♪...♩]

Times [x1...x32]

When **MIDI/Tempo Sync** is on, the LFO speed is set by **BPM**, **Base Note**, and **Times**, instead of **Frequency**. For more information, see "MIDI/Tempo Sync" on page 781.

LFO Type [Individual, Common1, Common2]

Selects either (individual) LFO, Common FX LFO1, or Common LFO2. p.781.

Common LFO Phase Offset [degrees] [+/-180]

Sets the phase offset when Type = Common 1 or Common 2. p.781.

OUTPUT

Wet/Dry [Dry, 1:99...99:1, Wet]

Sets the balance between the effect and the dry input. Unlike most effects, when this is set to Wet, the dry and effected signals will be heard at equal volume.

Source [Off...Tempo]

Selects a modulation source for Wet/Dry.

Amount [+/-100]

Sets the modulation amount for Wet/Dry.

073: Organ Vibrato/Chorus

This effect simulates the chorus and vibrato circuitry of a vintage organ. The modulation speed and depth can be customized.

This effect works the same as the Chorus/Vibrato included in the CX-3. For more information, see “7-1c: Vibrato/Chorus” on page 197.

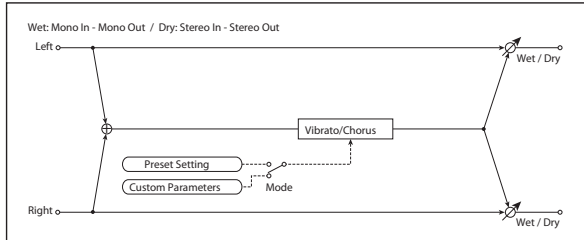

CONTROL

Input Trim [0...100]

Sets the input level.

Mode [Preset, Custom]

Selects either preset or custom settings.

PRESET

Type [V1, C1, V2, C2, V3, C3]

Selects the effect type when Mode=Preset.

V1/V2/V3 are variations of vibrato, and C1/C2/C3 are variations of chorus.

Source [Off...Tempo]

Selects the modulation source that will change the effect type.

Amount [-5...+5]

Sets the modulation amount for changing the effect type.

074: Rotary Speaker

This effect simulates a rotary speaker, and obtains a more realistic sound by simulating the rotor in the low range and the horn in the high range separately. The effect also simulates the stereo microphone settings.

Rotary Speaker speed indicator

In PROGRAM, COMBINATION, SEQUENCER, and SET LIST modes, if there is an active Rotary Speaker, its current state (Fast, Slow, or Stop) is shown at the top of the display. This includes both CX-3 Programs and any Rotary Speaker effects. If there are two or more active Rotary Speakers, the state of the fastest one is shown. For instance, if a Combination has three CX-3 Programs, whose current states are Fast, Slow, and Stop respectively, the menu bar will show Fast.

CUSTOM

Mix [0...100]

Sets the mix level of the direct sound when Mode=Preset.

Source [Off...Tempo]

Selects the modulation source that will control the mix level of the direct sound.

Amount [+/-100]

Sets the modulation amount for controlling the mix level of the direct sound.

Depth [0...100]

Sets the vibrato depth.

Source [Off...Tempo]

Selects the modulation source that will control vibrato depth.

Amount [+/-100]

Sets the modulation amount for controlling the vibrato depth.

Speed [Hz] [0.02...20.00]

Sets the vibrato speed.

Source [Off...Tempo]

Selects the modulation source for controlling the vibrato speed.

Amount [-20.00...+20.00]

Sets the modulation amount for controlling the vibrato speed.

OUTPUT

This is the standard effects output section, with modulatable control over wet/dry balance. For more information, see “OUTPUT” on page 764.

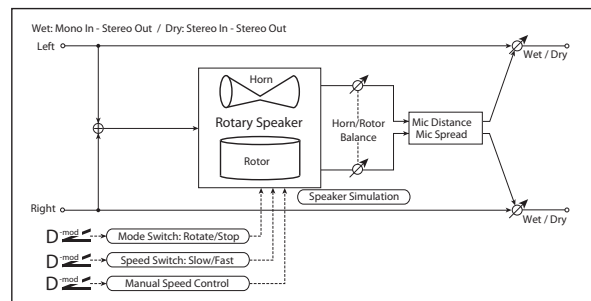

CONTROL

Mode Switch [Rotate, Stop]

Switches between speaker rotation and stop.

Source [Off...Tempo]

Selects a modulation source for Rotate/Stop.

Mode [Toggle, Moment]

This parameter controls how the modulation source switches between rotation and stop.

When **Mode = Toggle**, the speaker rotates or stops alternately each time you press the pedal or move the joystick. Via MIDI, rotation will switch between start and stop each time the modulation amount exceeds 64.

When **Mode = Moment**, the speaker rotates by default, and stops only when you press the pedal or move the joystick. Via MIDI, modulation values above 64 make the speaker rotate, and values below 64 make it stop.

Speed Switch  [Slow, Fast]

Switches the speaker rotation speed between slow and fast.

Source [Off...Tempo]

Selects a modulation source for Slow/Fast.

Mode [Toggle, Moment]

This parameter controls how the modulation source switches the rotation speed between slow and fast.

When **Mode = Toggle**, the speed will switch between slow and fast each time you press the pedal or move the joystick. Via MIDI, the speed will switch each time the modulation amount exceeds 64.

When **Mode = Moment** (short for Momentary), the speed is usually slow. It becomes fast only when you press the pedal or move the joystick. Via MIDI, modulation values above 64 set the speed to **Fast**, and values below 64 set it to **Slow**.

Manual Speed  [Off...Tempo]

This lets you control the rotation speed manually from a selected modulation source, instead of just switching between Slow and Fast. If you don't want to use manual control, set this to **Off**.

HORN

Ratio [Stop, 0.50...2.00]

Adjusts the horn rotation speed, which affects the high frequencies. **1.00** is the default setting. Selecting "Stop" will stop the rotation.

Acceleration [0...100]

On a real rotary speaker, the rotation accelerates or decelerates gradually when you switch between slow and fast, or stop and start. This parameter adjusts how quickly the Horn speeds up and slows down.

ROTOR

Ratio [Stop, 0.50...2.00]

Adjusts the rotor speed, which affects the low frequencies. **1.00** is the default setting. Selecting "Stop" will stop the rotation.

Acceleration [0...100]

This parameter adjusts how quickly the Rotor speeds up and slows down; see "Acceleration," above.

Horn/Rotor Balance [Rotor, 1...99, Horn]

Sets the level balance between the high-frequency horn and low-frequency rotor. See "Acceleration" on page 831.

MIC

These settings model a pair of stereo microphones, recording the rotary speaker.

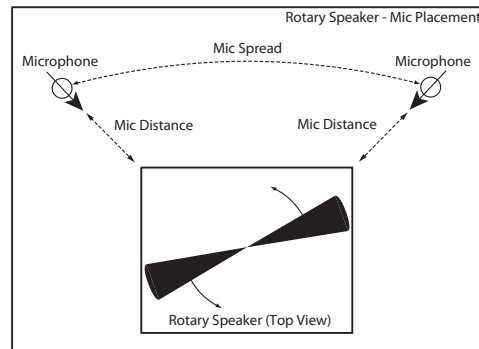

Distance [0...100]

This adjusts the distance between the rotary speaker and the microphones. Lower values bring the mics closer to the speaker.

Spread [0...100]

Sets the angle between the left and right microphones. Higher settings create a wider stereo effect.

OUTPUT

This is the standard effects output section, with modulatable control over wet/dry balance. For more information, see "OUTPUT" on page 764.

075: Rotary Speaker Pro OD

This is a stereo rotary speaker model, including amp overdrive and speaker simulation.

Rotary Speaker speed indicator

In PROGRAM, COMBINATION, SEQUENCER, and SET LIST modes, if there is an active Rotary Speaker, its current state (Fast, Slow, or Stop) is shown at the top of the display. For more information, see “Rotary Speaker speed indicator” on page 830.

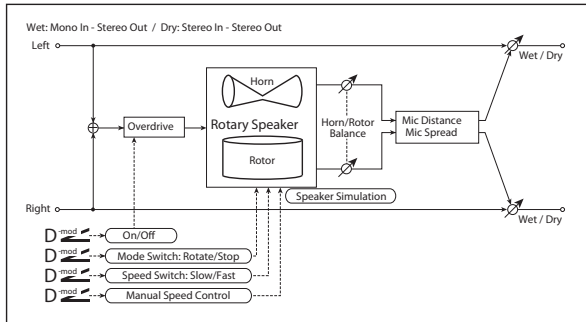

CONTROL

These parameters set up modulation to start and stop the rotary speaker, and to change its speed. This section is identical to that of the Rotary Speaker effect; for more information, see “CONTROL” on page 830.

OVERDRIVE

Switch **[Off, On]**

Switches overdrive on/off.

Source **[Off...Tempo]**

Selects a modulation source to switch overdrive on/off.

Mode **[Toggle, Moment]**

This parameter controls how the modulation source switches the overdrive on and off.

When **Mode** = **Toggle**, the overdrive turns on or off each time you press the pedal or move the joystick. Via MIDI, overdrive turns on or off each time the modulation amount exceeds 64.

When **Mode** = **Moment** (short for Momentary), the overdrive is normally off, and turns on only when you press the pedal or move the joystick. Via MIDI, modulation values above 64 turn it on, and values below 64 turn it off.

Gain **[0...100]**

Determines the degree of distortion.

Level **[0...100]**

Sets the overdrive output level.

Tone **[0...15]**

Sets the tonal quality of the overdrive.

HORN

These parameters control the speed and acceleration of the horn. They are identical to those of the Rotary Speaker effect; for more information, see “HORN” on page 831.

ROTOR

These parameters control the speed and acceleration of the rotor, the volume balance between the horn and rotor. They are identical to those of the Rotary Speaker effect; for more information, see “ROTOR” on page 831.

Speaker Simulator

Speaker Simulator **[Check-box]**

This part of the effect models the speakers themselves, creating a slightly warmer tone. Use the check-box to turn the speaker simulation on or off.

MIC

These settings model a pair of stereo microphones recording the rotary speaker. They are identical to those of the Rotary Speaker effect; for more information, see “MIC” on page 831.

OUTPUT

This is the standard effects output section, with modulatable control over wet/dry balance. For more information, see “OUTPUT” on page 764.

076: Rotary Speaker Pro CX

This effect models a vintage rotary speaker, with detailed control over both timbre and behavior. This effect model is equivalent to the CX-3 Classic model. For the more recent version of the Rotary Speaker model, use “197: Rotary Speaker Pro CX Custom” on page 899.

For more information on rotary speakers, see “7-2: Rotary Speaker” on page 199.

Rotary Speaker speed indicator

In PROGRAM, COMBINATION, SEQUENCER, and SET LIST modes, if there is an active Rotary Speaker, its current state (Fast, Slow, or Stop) is shown at the top of the display. For more information, see “Rotary Speaker speed indicator” on page 830.

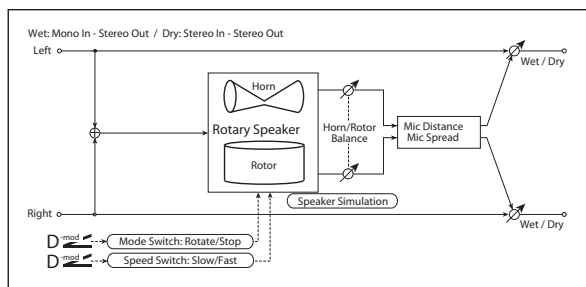

CONTROL

Mode Switch [Rotate, Stop]

This lets you stop the motion of the Rotary Speaker. Even when stopped, the speaker will still affect the timbre.

The horn and rotor can each take different amounts of time to start and stop their rotation. For more information, see the **Start Acceleration** and **Stop Deceleration** parameters under “HORN,” below.

Source [Off...Tempo]

This selects a modulation source to start and stop the Rotary Speaker.

Mode [Toggle, Moment]

This determines the behavior of the **Mode Switch**. For more information, see “Mode” on page 831.

Speed Switch [Slow, Fast]

Switches the speaker rotation speed between slow and fast

Source [Off...Tempo]

Selects a modulation source for Slow/Fast.

Mode [Toggle, Moment]

This determines the behavior of the **Speed Switch**. For more information, see “Mode” on page 831.

Fast Overrides Stop [Check-box]

On (checked): setting the **Speed Switch** to **Fast** will make the rotors speed up, even if the **Mode Switch** is set to **Stop**.

Off (un-checked): if the **Mode Switch** is set to **Stop**, the rotors will always stay stopped, regardless of the **Speed Switch**.

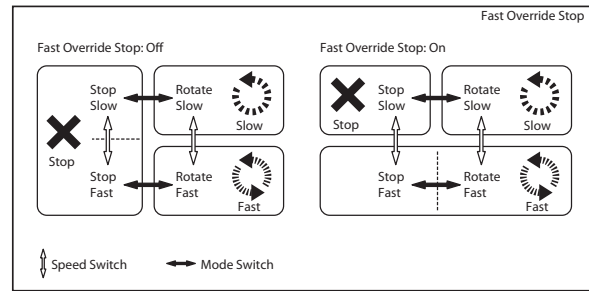

Horn Stop Phase [degrees] [Free, -180...+180]

When the **Mode Switch** is set to **Stop**, the Horn gradually comes to rest pointing one way or another. This allows you to control where it will stop.

Free lets it come to rest naturally, at a more or less random spot. The other settings, **-180** to **+180**, let you force it to land in a specific position.

The speaker position has a dramatic effect on the tone, so specifying a fixed position allows you to achieve consistent timbral results.

Rotor Stop Phase [degrees] [Free, -180...+180]

This determines where the Rotor will land when the **Mode Switch** is set to **Stop**. For more details, see “Horn Stop Phase [degrees],” above.

HORN

The horn carries the effect’s high frequencies, while the rotor carries the low frequencies.

Fast Speed [0...100]

This specifies the speed of the Horn when the **Speed Switch** is set to **Fast**.

Slow Speed [0...100]

This specifies the speed of the Horn when the **Speed Switch** is set to **Slow**.

Acceleration [0...100]

This sets how long it takes the Horn to change from the **Slow** speed to the **Fast** speed.

Deceleration [0...100]

This sets how long it takes the Horn to change from the **Fast** speed to the **Slow** speed.

Start Acceleration [0...100]

This sets how long it takes the Horn to come up to speed after the **Mode Switch** has changed from **Stop** to **Rotate**.

Stop Deceleration [0...100]

This sets how long it takes the horn to come to rest after the **Mode Switch** has changed from **Rotate** to **Stop**.

ROTOR

The rotor carries the low frequencies of the Rotary Speaker. Its parameters are identical to those of the Horn, above.

Fast Speed [0...100]

Slow Speed [0...100]

Acceleration [0...100]

Deceleration [0...100]

Start Acceleration [0...100]

Stop Deceleration [0...100]

Balance and Tone

Horn/Rotor Balance [Rotor, 1...99, Horn]

Sets the volume balance between the high-frequency horn and low-frequency rotor.

Speaker Simulator [Check-box]

Switches speaker simulation on/off.

Match CX-3 Tone [Off, Amp 1, Amp 2]

When using this effect on a CX-3 Program, this setting will adjust the tone appropriately for the CX-3's Amp Type. If **AmpType = Type1** or **2**, use the corresponding **Amp1** or **2** setting. If **Amp Type = Pre Amp**, turn this parameter **Off**.

MIC

These settings model two pairs of stereo microphones recording the rotary speaker—one pair each for the horn and rotor. In the real world, this would require an elaborate setup, or even splitting the rotary speaker into two—but it's relatively easy in the software world of the NAUTILUS, and it gives you separate control over the tone and stereo spread of the high and low frequencies.

The other rotary speaker effects have only one pair of mics, but are otherwise similar; for more information, see "MIC" on page 831.

Horn Distance [0...100]

Horn Spread [0...100]

Rotor Distance [0...100]

Rotor Spread [0...100]

OUTPUT

This is the standard effects output section, with modulatable control over wet/dry balance. For more information, see "OUTPUT" on page 764.

Delay

077: L/C/R Delay

This multitap delay outputs three Tap signals to the left, right, and center respectively. You can also adjust the stereo width of the delays.

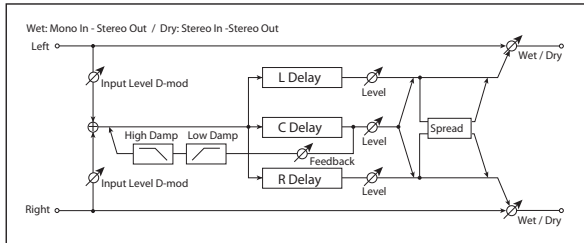

INPUT

Input Level Dmod [%] [+/-100]
Sets the modulation amount of the input level. p.825.

Source [Off...Tempo]
Selects the modulation source for the input level. p.825.

DELAY

L Delay Time [msec] [0...2730]
Sets the delay time of the Left Delay.

Level [0...50]
Sets the output level of the Left Delay.

C Delay Time [msec] [0...2730]
Sets the delay time of the Center Delay.

Level [0...50]
Sets the output level of the Center Delay.

R Delay Time [msec] [0...2730]
Sets the delay time of the Right Delay.

Level [0...50]
Sets the output level of the Right Delay.

Feedback (C Delay) [+/-100]
Sets the feedback amount of the Center Delay

Source [Off...Tempo]
Selects the modulation source of the Center Delay feedback amount.

Amount [+/-100]
Sets the modulation amount of the Center Delay feedback amount.

High Damp [%] [0...100]
This controls a low-pass filter in the feedback loop, which “damps” (reduces) high frequencies. Higher settings mean more damping, resulting in increasingly darker timbres as the feedback continues.

Low Damp [%] [0...100]
This controls a high-pass filter in the feedback loop, which “damps” (reduces) low frequencies. Higher settings mean more damping, resulting in increasingly highpassed, lighter timbres as the feedback continues.

Spread [0...50]
This controls the stereo width of the effect. The stereo image is widest with a value of 50, and narrows to mono with a value of 0.

OUTPUT

This is the standard effects output section, with modulatable control over wet/dry balance. For more information, see “OUTPUT” on page 764.

078: L/C/R Long Delay

This multitap delay outputs three Tap signals to left, right and center respectively. You can set a maximum of 5,460msec for the delay time.

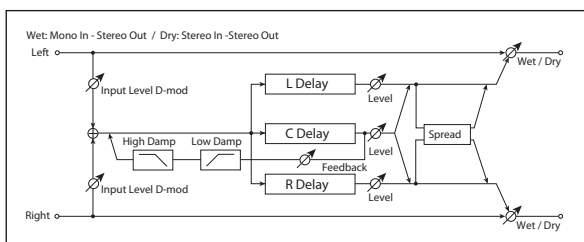

INPUT

Input Level Dmod [%] [+/-100]
Sets the modulation amount of the input level. p.825.

Source [Off...Tempo]
Selects the modulation source for the input level. p.825.

DELAY

L Delay Time [msec] [0...5460]
Sets the delay time of the Left Delay.

Level [0...50]
Sets the output level of the Left Delay.

C Delay Time [msec] [0...5460]
Sets the delay time of the Center Delay.

Level [0...50]
Sets the output level of the Center Delay.

R Delay Time [msec] [0...5460]

Sets the delay time of the Right Delay.

Level [0...50]

Sets the output level of the Right Delay.

Feedback (C Delay) D_{mod} [+/-100]

Sets the feedback amount of the Center Delay.

Source [Off...Tempo]

Selects the modulation source for the Center Delay feedback.

Amount [+/-100]

Sets the modulation amount of the Center Delay feedback.

High Damp [%] [0...100]

Sets the amount of high-frequency attenuation for the feedback path.

Low Damp [%] [0...100]

This controls the low-frequency damping in the feedback loop. See “Low Damp [%]” on page 835.

Spread [0...50]

This controls the stereo width of the effect. The stereo image is widest with a value of 50, and narrows to mono with a value of 0.

OUTPUT

This is the standard effects output section, with modulatable control over wet/dry balance. For more information, see “OUTPUT” on page 764.

079: Stereo/Cross Delay

This is a stereo delay with adjustable feedback routing, high and low damping, modulatable feedback and input level, and up to 1,360msec of delay time.

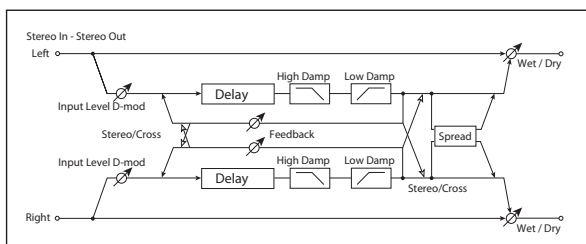

INPUT

Input Level Dmod [%] D_{mod} [+/-100]

Sets the modulation amount of the input level. p.825.

Source [Off...Tempo]

Selects the modulation source for the input level. p.825.

DELAY

Stereo/Cross [Stereo, Cross]

Switches between stereo delay and cross-feedback delay.

L Delay Time [msec] [0.0...1360.0]

Sets the delay time for the left channel.

R Delay Time [msec] [0.0...1360.0]

Sets the delay time for the right channel.

L Feedback D_{mod} [+/-100]

Sets the feedback amount for the left channel.

R Feedback D_{mod} [+/-100]

Sets the feedback amount for the right channel.

Source [Off...Tempo]

Selects the modulation source of feedback amount.

L Amount [+/-100]

Sets the modulation amount of the left channel feedback.

R Amount [+/-100]

Sets the modulation amount of the right channel feedback.

High Damp [%] [0...100]

Sets the amount of high-frequency attenuation for the feedback path.

Low Damp [%] [0...100]

This controls the low-frequency damping in the feedback loop. See “Low Damp [%]” on page 835.

Spread [-50...+50]

This controls the stereo width of the effect. The stereo image is widest with a value of 50, and narrows to mono with a value of 0.

OUTPUT

This is the standard effects output section, with modulatable control over wet/dry balance. For more information, see “OUTPUT” on page 764.

080: Stereo/Cross Long Delay

This is a stereo delay with adjustable feedback routing, high and low damping, modulatable feedback and input level, and up to 2,730msec of delay time.

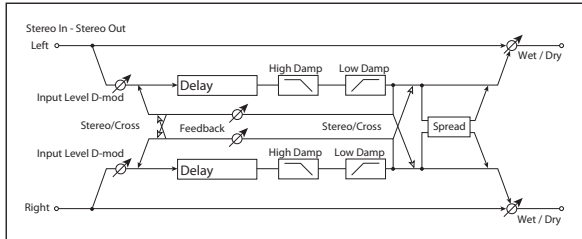

INPUT

Input Level Dmod [%] D_{mod} [+/-100]

Sets the modulation amount for the input level. For more information, see “Input Level Dmod [%]” on page 825.

Source [Off...Tempo]

Selects the modulation source for the input level. For more information, see “Source” on page 825.

DELAY

Stereo/Cross [Stereo, Cross]

This changes the feedback routing.

Stereo means that the left and right channels feed back into themselves, preserving the stereo image.

Cross makes the left channel feeds back into the right, and vice-versa.

L Delay Time [msec] [0.0...] 2730.0

Sets the delay time for the left channel.

R Delay Time [msec] [0.0...] 2730.0

Sets the delay time for the right channel.

L Feedback D_{mod} [+/-100]

Sets the feedback amount for the left channel.

R Feedback D_{mod} [+/-100]

Sets the feedback amount for the right channel.

Source [Off...Tempo]

Selects the modulation source of feedback amount.

L Amount [+/-100]

Sets the modulation amount of the left channel feedback.

R Amount [+/-100]

Sets the modulation amount of the right channel feedback.

High Damp [%] [0...100]

Sets the amount of high-frequency attenuation for the feedback path.

Low Damp [%] [0...100]

This controls the low-frequency damping in the feedback loop. See “Low Damp [%]” on page 835.

Spread [-50...+50]

This controls the stereo width of the effect. The stereo image is widest with a value of 50, and narrows to mono with a value of 0.

OUTPUT

This is the standard effects output section, with modulatable control over wet/dry balance. For more information, see “OUTPUT” on page 764.

081: Stereo Multitap Delay

The left and right Multitap Delays have two taps respectively. Changing the routing of feedback and tap output allows you to create various patterns of complex effect sounds.

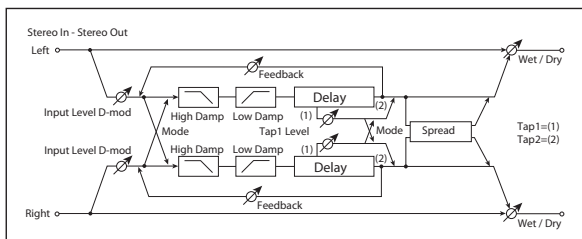

INPUT

Input Level Dmod [%] D_{mod} [+/-100]

Sets the modulation amount of the input level. See “Input Level Dmod [%]” on page 825.

Source [Off...Tempo]

Selects the modulation source for the input level. p.825.

DELAY

Mode [Normal, Cross Feedback, Cross Pan1, Cross Pan2]

This lets you alter the stereo image by switching the inputs and feedback paths of the left and right delays, as shown in the figure below. In order for this to be effective, the input needs to be a true stereo signal.

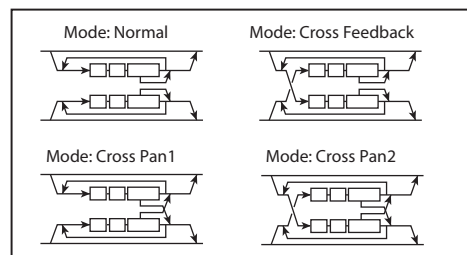

Tap1 Time [msec] [0.0...1360.0]

Sets the Tap1 delay time.

Tap2 Time [msec] [0.0...1360.0]

Sets the Tap2 delay time.

Feedback (Tap2)  [+/-100]

Sets the Tap2 feedback amount.

Source [Off...Tempo]

Selects the modulation source of the Tap2 feedback amount.

Amount [+/-100]

Sets the modulation amount of the Tap2 feedback amount.

Tap1 Level [0...100]

This lets you adjust the relative volume of Tap1, compared to Tap2 (which is always at the maximum volume). Setting a lower volume for Tap1 can help to create interesting accent patterns.

High Damp [%] [0...100]

This controls the high-frequency attenuation in the feedback loop.

Low Damp [%] [0...100]

This controls the low-frequency damping in the feedback loop. See “Low Damp [%]” on page 835.

Spread  [+/-100]

This controls the stereo width of the effect. The stereo image is widest with a value of **50**, and narrows to mono with a value of **0**.

Source [Off...Tempo]

Selects the modulation source for **Spread**.

Amount [+/-100]

Sets the modulation amount for **Spread**.

OUTPUT

This is the standard effects output section, with modulatable control over wet/dry balance. For more information, see “OUTPUT” on page 764.

082: Stereo Modulation Delay

This stereo delay uses either an LFO or a Dmod source to modulate the delay time. This causes the delay’s pitch to vary, creating an effect which swells and shimmers like a cross between an echo and a chorus.

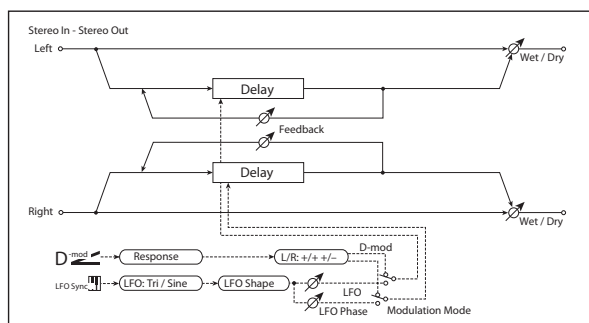

CONTROL

Modulation Mode [LFO, Dmod]

This selects whether the delay time will be swept by the LFO or by the selected Dmod source.

Dmod Modulation  [L/R: +/+, L/R: +/-]

This applies only if **Modulation Mode** is set to **Dmod**.

L/R: +/+: the Dmod source modulates both left and right delays equally.

L/R: +/-: the Dmod source modulates left and right inversely, for a deeper stereo effect.

Source [Off...Tempo]

Selects a modulation source to control the delay time. This applies only if **Modulation Mode** is set to **Dmod**.

Response [0...30]

This controls how quickly the delay times change in response to the modulation source. Higher values mean faster response times.

LFO

All of the LFO controls apply only when the **Modulation Mode** is set to **LFO**.

Waveform [Triangle, Sine]

Selects the LFO Waveform.

Shape [-100...+100]

Changes the curvature of the LFO Waveform. For more information, see “Shape” on page 784.

L LFO Phase [degrees] [-180...+180]

This sets the initial phase of the left LFO. The relationship between this and the **R LFO Phase** controls the depth of the stereo effect and the richness of the pitch changes. As a start, try setting one to +90 and the other to -90.

R LFO Phase [degrees] [-180...+180]

This sets the initial phase of the right LFO.

Dmod Sync  [Check-box]

This enables reset of the LFOs from a Dmod source, as selected below.

Source [Off...Tempo]

If **Dmod Sync** is **On**, this selects the modulation source to reset the LFOs, using the initial phases set by **L LFO Phase** and **R LFO Phase** above.

For example, if you set the **Source** to Gate 2, playing on the keyboard will reset the LFOs so that the modulation sounds the same at the start of each phrase.

 The LFOs are reset when the modulation value changes from 63 or smaller to 64 or higher.

Frequency [Hz]  [0.02...20.00]

This sets the LFO speed, in Hz.

MIDI/Tempo Sync  [Check-box]

BPM [MIDI, 40.00...300.00]

Base Note 

Times [x1...x32]

When **MIDI/Tempo Sync** is on, the LFO speed is set by **BPM**, **Base Note**, and **Times**, instead of **Frequency**. For more information, see “MIDI/Tempo Sync” on page 781.

Type [Individual, Common1, Common2]

This controls whether the effect uses its individual LFO, or one of the Common FX LFOs. For more information, see “LFO Type” on page 781.

Common LFO Phase Offset [degrees] [+/-180]

When **Type** is set to **Common FX LFO 1** or **2**, this lets you offset the phase from the master LFO.

MOD DELAY

L Delay Time [msec] [0.0...1000.0]

Sets the delay time for the left channel.

R Delay Time [msec] [0.0...1000.0]

Sets the delay time for the right channel.

L Depth [0...200]

Sets the amount of pitch modulation for the left channel. 0...100 produce chorus-like effects; over 100 produces more obvious pitch-shifting.

R Depth [0...200]

Sets the amount of pitch modulation for the right channel.

L Feedback [+/-100]

Sets the amount of feedback for the left delay. Negative values invert the phase.

R Feedback [+/-100]

Sets the amount of feedback for the right delay.

OUTPUT

This is the standard effects output section, with modulatable control over wet/dry balance. For more information, see “OUTPUT” on page 764.

083: Stereo Dynamic Delay

This stereo delay uses the input signal level to control either the wet/dry mix or the feedback level. You can use this to create:

- Ducked delays, in which the delays get softer when the input is loud (the delays “duck” to get out of the way).
- Gated delays, in which the delays are louder when the input is loud. For instance, you can create a thick, layered lead sound using delays, and then make the level or feedback of the delays reduce automatically when you stop playing.

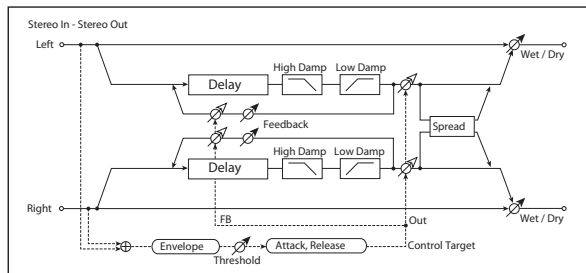

CONTROL

Target [None, Output Level, Feedback]

This selects the modulation target for the input signal.

Output Level modulates the **Wet/Dry** mix.

Feedback modulates the **Feedback** amount.

Polarity [+ , -]

+ (**positive**): The modulation applies only when the input signal is *below* the **Threshold**. Use this to lower the effect level when the input signal is quiet.

- (**negative**): The modulation applies only when the input signal is *above* the **Threshold**. Use this to lower the effect level when the input signal is loud (for “ducking”).

Offset [0...100]

This controls the amount of modulation for the **Target** parameter (either **Output Level** or **Feedback**), as a percentage of the parameter’s value.

Threshold [0...100]

This sets the input signal level at which the ducking or gating occurs, according to the **Polarity** setting.

Attack [1...100]

This controls how fast the gating or ducking starts after the **Threshold** is crossed.

Release [1...100]

This controls how fast the gating or ducking stops, after the **Threshold** is crossed in the opposite direction.

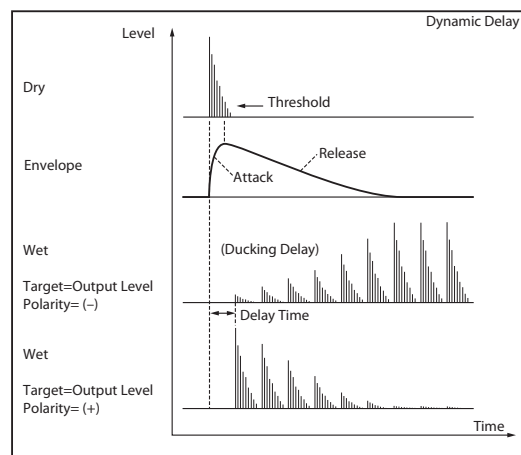

DELAY

L Delay Time [msec] [0.0...1360.0]

Sets the delay time for the left channel.

R Delay Time [msec] [0.0...1360.0]

Sets the delay time for the right channel.

Feedback [+/-100]

Sets the feedback amount.

High Damp [%] [0...100]

This controls the high-frequency attenuation in the feedback loop. See “High Damp [%]” on page 835.

084: Stereo Auto Panning Delay

This stereo delay effect pans the delay sound left and right using the LFO.

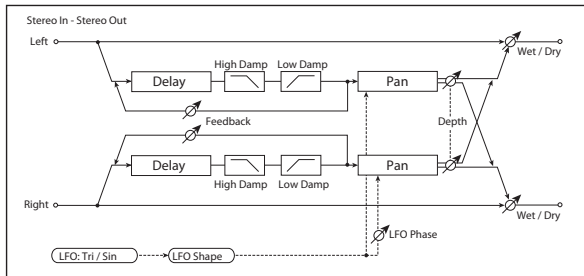

DELAY

L Delay Time [msec] [0.0...1360.0]

Sets the delay time for the left channel.

R Delay Time [msec] [0.0...1360.0]

Sets the delay time for the right channel.

L Feedback [+/-100]

Sets the feedback amount for the left channel.

R Feedback [+/-100]

Sets the feedback amount for the right channel.

High Damp [%] [0...100]

This controls the high-frequency attenuation in the feedback loop. See “High Damp [%]” on page 835.

Low Damp [%] [0...100]

This controls the low-frequency damping in the feedback loop. See “Low Damp [%]” on page 835.

LFO

Waveform [Triangle, Sine]

Selects the LFO Waveform.

Shape [+/-100]

Changes the curvature of the LFO Waveform. See “Shape” on page 784.

Low Damp [%] [0...100]

This controls the low-frequency damping in the feedback loop. See “Low Damp [%]” on page 835.

Spread [+/-100]

Sets the width of the stereo image of the effect sound. For more information, see “Spread” on page 835.

OUTPUT

This is the standard effects output section, with modulatable control over wet/dry balance. For more information, see “OUTPUT” on page 764.

Phase [degrees] [-180...+180]

Sets the LFO phase difference between the left and right. See “Phase [degrees]” on page 819.

Frequency [Hz] **Mod** [0.02...20.00]

This sets the LFO speed, in Hz. It applies only when **MIDI/Tempo Sync**, below, is **Off**.

MIDI/Tempo Sync **Mod** [Check-box]

BPM [MIDI, 40.00...300.00]

Base Note []

Times [x1...x32]

When **MIDI/Tempo Sync** is on, the LFO speed is set by **BPM**, **Base Note**, and **Times**, instead of **Frequency**. For more information, see “MIDI/Tempo Sync” on page 781.

Type [Individual, Common1, Common2]

This controls whether the effect uses its individual LFO, or one of the Common FX LFOs. For more information, see “LFO Type” on page 781.

Common LFO Phase Offset [degrees] [+/-180]

When **Type** is set to **Common FX LFO 1** or **2**, this lets you offset the phase from the master LFO.

AUTO PAN

Depth **Mod** [0...100]

Sets the panning width.

Source [Off...Tempo]

Selects the modulation source for the panning width.

Amount [+/-100]

Set the modulation amount of the panning width.

OUTPUT

This is the standard effects output section, with modulatable control over wet/dry balance. For more information, see “OUTPUT” on page 764.

085: Tape Echo

This effect models a tape echo unit with three playback heads, including the distortion and tonal changes typical of magnetic tape.

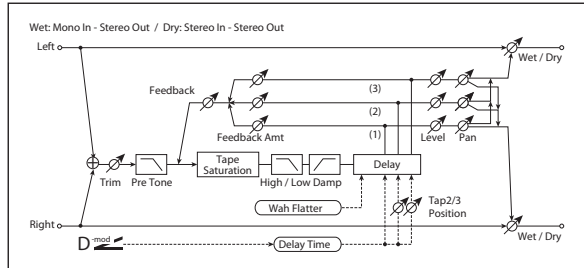

INPUT

Trim [0...100]

Sets the input gain.

Pre Tone [0...100]

This models the reduced high frequencies of an analog tape delay, before the saturation stage. Lower settings create a darker tone.

WOW & FLUTTER

This section models the instability of the tape machine's motors. As the speed of the motor fluctuates, the pitch changes slightly. This introduces a pleasant chorus-like effect.

Frequency [Hz] [0.02...1.00]

Sets the frequency at which pitch variation occurs.

Depth [0...100]

Sets the depth of the pitch change.

TAPE ECHO

Delay Time

Delay Time(Tap1) [msec] D_{mod} [0...2700]

This parameter sets the delay time of Tap 1.

Also, Taps 2 and 3 are specified as a percentage (%) of this delay time. Taps 2 and 3 always stay in proportion to Tap 1, even when the delay time is modulated.

Source [Off...Tempo]

Selects the modulation source for the delay time.

Amount [-2700...]+2700

Sets the modulation amount for the delay time.

Tap2 Position [%] [0...100]

Sets the delay time of Tap 2, as a percentage of Tap 1's delay time.

Tap3 Position [%] [0...100]

Sets the delay time of Tap 3, as a percentage of Tap 1's delay time.

Level and Pan 1...3

Each tap has its own controls for level and pan.

Tap1...3 Level [0...100]

Sets the tap's output level.

Pan [L, 1...99, R]

Sets the tap's stereo position.

Feedback

Tap1...3 Feedback Amount [+/-100]

Sets the individual tap's feedback level. Negative values invert the phase. These individual levels are summed together, and then the final level is controlled by **Feedback Level**, below.

Feedback Level D_{mod} [0...100]

Sets the overall level of feedback.

Source [Off...Tempo]

Selects the modulation source for the **Feedback Level**.

Amount [+/-100]

Sets the modulation amount for the **Feedback Level**.

Tone

High Damp [%] [0...100]

This cuts the high frequencies in both the main output and the feedback. Higher settings create a darker tone.

Low Damp [%] [0...100]

This cuts the low frequencies in both the main output and the feedback. Higher settings mean less low-end.

Saturation [0...100]

This models the distortion of an analog tape delay.

OUTPUT

This is the standard effects output section, with modulatable control over wet/dry balance. For more information, see "OUTPUT" on page 764.

086: Multiband Mod. Delay

This effect divides the input signal into low, mid, and high-frequency bands, and applies a modulation delay to each band.

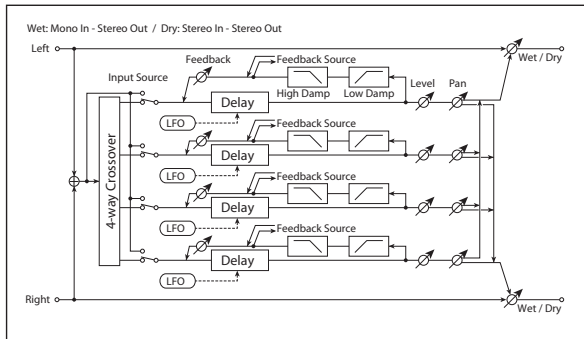

Dmod

Input Level [%] D_{mod} [+/-100]

Sets the modulation amount of the input level. p.825.

Src (Source) [Off...Tempo]

Selects the modulation source for the input level. p.825.

Feedback Src (Source) [Off...Tempo]

Selects the modulation source of feedback amount.

Output Level Src (Source) [Off...Tempo]

Selects the modulation source for the output level.

XOVER FILTER

For a description of the on-screen Crossover Filter graphic, see "004: St.Multiband Compressor" on page 768.

1-2 [Hz] [20...20.00k]

Sets the frequency at which bands 1 and 2 are divided.

2-3 [Hz] [20...20.00k]

Sets the frequency at which bands 2 and 3 are divided.

3-4 [Hz] [20...20.00k]

Sets the frequency at which bands 3 and 4 are divided.

BAND1 DELAY

Input [Xover, Direct]

Selects the input for band 1: either the signal from the crossover, or the direct signal.

Feedback Src (Source) [Band1, Band2, Band3, Band4]

Selects the feedback source for band 1. This lets you connect the feedback of each band to other bands.

Time [msec] [0.0...1200.0]

Sets the delay time for the band 1.

Pan [L, 1...99, R]

Sets the panning for band 1.

Feedback D_{mod} [+/-100]

Sets the feedback amount for band 1.

Amt (Feedback Amount) [+/-100]

Sets the amount of modulation for the band 1 feedback.

Low Damp [%] [0...100]

Sets the amount of low-frequency attenuation for band 1.

High Damp [%] [0...100]

Sets the amount of high-frequency attenuation for band 1.

Output Level D_{mod} [0...100]

Sets the output level for band 1.

Amt (Output Level Amount) [+/-100]

Sets the amount of modulation for band 1's output level.

BAND2 DELAY

Band 2 has the same parameters as the "BAND1 DELAY," above.

BAND3 DELAY

Band 3 has the same parameters as the "BAND1 DELAY," above.

BAND4 DELAY

Band 4 has the same parameters as the "BAND1 DELAY," above.

BAND1 LFO

Frequency [Hz] [0.02...20.00]

Sets the LFO speed for band 1.

Depth [0...187]

Sets the LFO modulation depth for band 1.

Type [Indiv., Cmn1, Cmn2]

Selects LFO, Common FX LFO1, or Common LFO2 for band 1. p.781.

Cmn LFO [deg] (Common LFO Phase Offset [degrees]) [-180...+180]

Sets the phase offset when Type = Common 1 or Common 2. p.781.

BAND2 LFO

Band 2's LFO has the same parameters as the "BAND1 LFO," above.

BAND3 LFO

Band 3's LFO has the same parameters as the "BAND1 LFO," above.

BAND4 LFO

Band 4's LFO has the same parameters as the "BAND1 LFO," above.

087: Reverse Delay

This is a delay that plays back the input signal in reverse. You can also continue feedback while alternating playing the signal in reverse and forward directions.

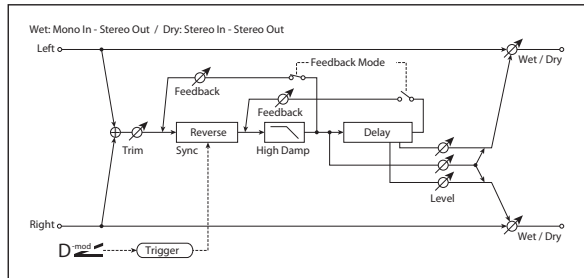

INPUT

Input Level Dmod [%] D_{mod} **[+/-100]**

Sets the modulation amount of the input level.

Source **[Off...Tempo]**

Selects the modulation source for the input level.

REVERSE DELAY

Reverse Time [msec] **[0...900]**

Sets the length of the reverse playback (the delay time). For more information, see "Reverse Time and Sync Source," below.

Level **[0...100]**

Sets the output level of the reverse playback.

L Post-Delay Time [msec] **[0...900]**

Sets the delay time of the Left Tap.

Level **[0...100]**

Sets the output level of the Left Tap.

R Post-Delay Time [msec] **[0...900]**

Sets the delay time of the Right Tap.

Level **[0...100]**

Sets the output level of the Right Tap.

Feedback Mode **[Reverse, Reverse/Forward]**

Reverse: the feedback plays in reverse.

Reverse/Forward: the feedback alternates between playing backwards and forwards, as shown below.

OUTPUT

This is the standard effects output section, with modulatable control over wet/dry balance. For more information, see "OUTPUT" on page 764.

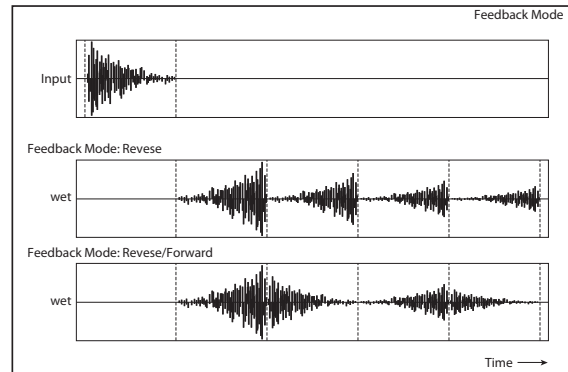

Feedback D_{mod} **[+/-100]**

Sets the feedback amount.

Source **[Off...Tempo]**

Selects the modulation source of feedback amount.

Amount **[+/-100]**

Sets the feedback amount.

High Damp [%] **[0...100]**

Sets the amount of high-frequency attenuation for the feedback path.

Sync Source D_{mod} **[Off...Tempo]**

Selects a modulation source to reset the start point of the reverse delay. For more information, see "Reverse Time and Sync Source," below.

Reverse Time and Sync Source

The sound will be played in reverse for the duration specified by **Reverse Time**. You can reset the dividing point for reverse playback by specifying a modulation source for **Sync Source**.

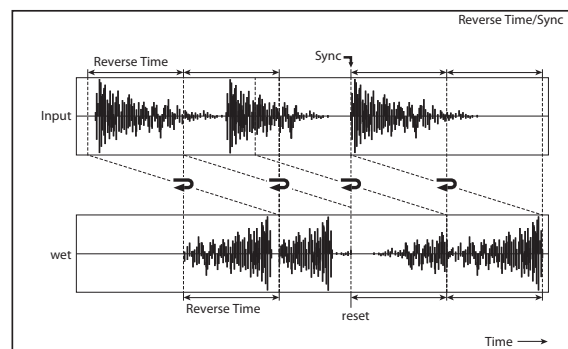

If you set **Sync Source** to Gate1, the delay will be reset at each note-on. This means that you will always hear the reverse playback of the sound that occurs between the note-on and the specified **Reverse Time**.

If you don't specify a **Sync Source**, the location at which reverse playback starts will be indeterminate.

Note: Resetting the delay (using **Sync Source**) while reverse playback is still being heard may cause noise artifacts.

For drums or short phrases, you'll need to adjust **Reverse Time** appropriately in order to use this effectively.

088: Hold Delay

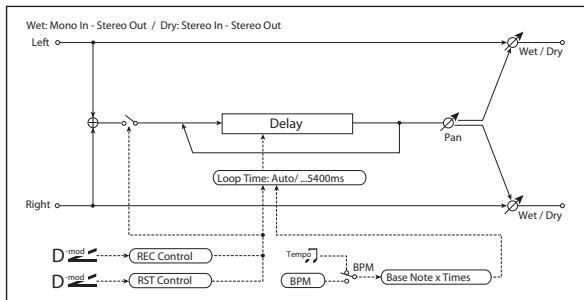

This effect records the input signal and plays it back as a loop, with overdub recording for creating multiple layers. You can use modulation sources to record and clear the loop, for simple real-time performance. The delay can sync to the system tempo, and is long enough for 2 measures of 4/4 at 90 bpm.

REC CONTROL

You can start recording by using a Dmod source, or by manually pressing the on-screen **Manual Rec Control** check-box. Recording always overdubs with the existing loop; to clear the loop, use “RESET CONTROL,” below.

Source [Off...Tempo]

This selects a modulation source to enable and disable recording. Modulation values of 64 or higher turn recording on; values of 63 or lower turn it off.

Manual Rec Control [Check-box]

This check-box lets you turn on recording manually, without using a controller. Just check the box to start recording, and un-check it to stop.

RESET CONTROL

Resetting erases the audio from the loop, making it silent and letting you start again from scratch. As with recording, you can reset using a Dmod source or an on-screen check-box.

If the **Loop Time** is set to Auto, it will be reset as well.

Source [Off...Tempo]

This selects a modulation source for Reset. Modulation values of 64 or higher will start the Reset; values of 63 or lower have no effect. You don't have to hold the modulation for the entire duration of the loop, but do make sure to hold it for about half a second, to ensure that the loop is completely cleared.

Manual Reset Control [Check-box]

This check-box manually resets the loop.

OUTPUT

This is the standard effects output section, with modulatable control over wet/dry balance. For more information, see “OUTPUT” on page 764.

HOLD DELAY

Loop Time [msec] [Auto, 1...5400]

This applies only when **MIDI/Tempo Sync** is off.

With **Auto**, the loop time is automatically set to the length of the recorded phrase, up to a maximum of 5,400msec.

1...5400 sets a specific time in milliseconds.

MIDI/Tempo Sync [Check-box]

This specifies whether delay time is set in milliseconds, or as a note value relative to tempo.

BPM [MIDI, 40.00...300.00]

MIDI syncs to the system tempo; 40-240 sets the tempo manually for this individual effect.

Time Over? > [---, OVER!]

The maximum delay time is 5,400msec. If the combination of **BPM**, **Base Note**, and **Times** exceeds this limit, the error message “OVER!” will appear. If this occurs, change the delay time parameters so that this message no longer appears.

Base Note [---. . .]

This sets the basic length of the loop, relative to the BPM setting. The values range from a 32nd note to a whole note, including triplets.

Times [x1...x32]

This multiplies the length of the Base Note. For instance, if the Base Note is set to a whole note, and Times is set to 32 the loop will last for two measures.

Pan [L100...L1, C, R1...R100]

Sets the stereo position of the effect output.

Source [Off...Tempo]

Selects the modulation source for **Pan**.

Amount [+/-100]

Sets the modulation amount for **Pan**.

OUTPUT

This is the standard effects output section, with modulatable control over wet/dry balance. For more information, see “OUTPUT” on page 764.

Using the Hold Delay

Recording layered loops with the Hold Delay is easy. To do so:

1. On the **IFX Insert FX** page, select the **Hold Delay** effect.

This is an easy way to get to the default effects settings, which we'll be using:

- **REC Source:** JS +Y: CC#01
 - **Reset Source:** JS -Y: CC#02
 - **Manual Rec Control:** Off
 - **Manual Reset Control:** Off
 - **Loop Time [msec]:** Auto
 - **MIDI/Tempo Sync:** Off
2. **Push the main joystick (not the Vector Joystick) in the +Y direction (away from you).**

This starts the recording.

3. **Play a phrase.**
4. **Release the joystick to its original position.**

This stops the recording. The phrase will now start to loop. Since **Loop Time** is set to **Auto**, the loop's duration will match that of the recording.

5. **Push the main joystick in the +Y direction again.**
6. **Play another phrase, over the loop.**
7. **Release the joystick to its original position.**

Now, you should hear what you just played layered over the first loop. You can overdub as many passes as you like.

To clear the loop and start over:

8. **Pull the joystick in the -Y direction (towards you).**

Hold Delay is mono

The Hold Delay uses a single, long, mono delay line (although you can control the pan of the delay). For best results with stereo effects, such as chorus and reverb, use the stereo effects after the Hold Delay.

089: Auto Reverse

This effect records the input signal and automatically plays it in reverse (the effect is similar to a tape reverse sound).

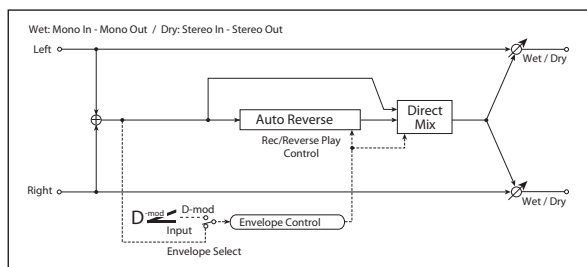

CONTROL

Envelope Select **[Dmod, Input]**

This selects whether the start and end of recording is controlled via the modulation source or the input signal level. After recording is completed, the reverse playback starts immediately.

Dmod: the input signal will be recorded only when the value of the specified modulation **Source** is 64 or higher.

Input: the input signal will be recorded only when its level exceeds the **Threshold** level.

Source **[Off...Tempo]**

Selects the modulation source that controls recording when Envelope Select is set to Dmod.

Threshold **[0...100]**

Sets the recording start level when Envelope Select is set to Input.

Response **[0...100]**

This sets the speed of the response to the end of recording. Set a smaller value when you are recording a phrase or rhythm pattern, and set a higher value if you are recording only one note.

REVERSE

Mode **[Single, Multi]**

When **Mode** is set to **Single**, you can set up to 2,640msec for **Reverse Time**. If recording starts during the reverse playback, the playback will be interrupted.

When **Mode** is set to **Multi**, you can make another recording during the reverse playback. However, the maximum **Reverse Time** is limited to 1,320msec.

If you wish to use this with longer phrases or rhythm patterns, set **Mode** to **Single**. If you don't need a long playback time, and want playback and record to overlap, set **Mode** to **Multi**.

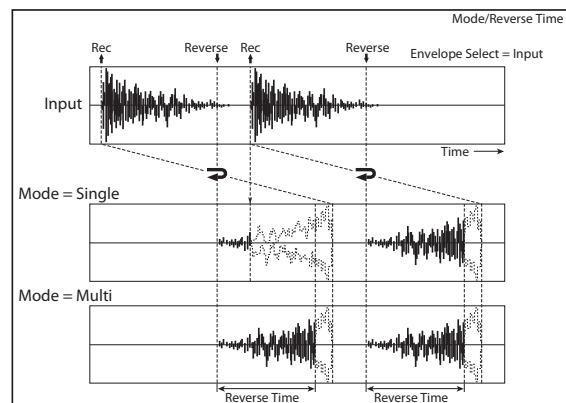

Reverse Time [msec] **[20...2640]**

This specifies the maximum time of the reverse playback. For short, single-note slapback effects, set the **Reverse Time** to a low value.

Direct Mix **[Always On, Always Off, Cross Fade]**

Selects how the dry sound is mixed. For more information, see "Direct Mix" on page 818.

OUTPUT

This is the standard effects output section, with modulatable control over wet/dry balance. For more information, see "OUTPUT" on page 764.

090: Sequence BPM Delay

This four-tap tempo delay includes a selection of patterns in 16th notes and dotted 8th notes.

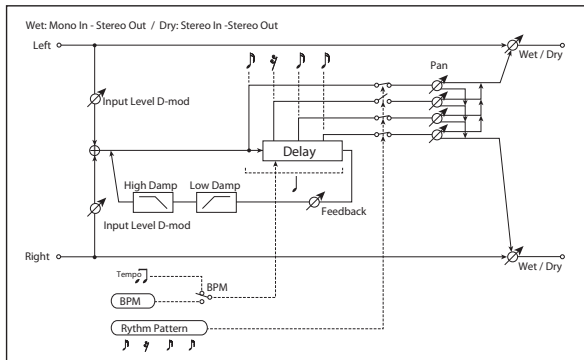

High Damp [%] [0...100]

Sets the amount of high-frequency attenuation for the feedback path.

Low Damp [%] [0...100]

Sets the amount of low-frequency damping for the feedback path.

OUTPUT

This is the standard effects output section, with modulatable control over wet/dry balance. For more information, see “OUTPUT” on page 764.

INPUT

Input Level Dmod [%] D_{mod} [+/-100]

Sets the modulation amount of the input level. p.825.

Source [Off...Tempo]

Selects the modulation source for the input level. p.825.

DELAY

BPM BPM [MIDI, 40.00...300.00]

MIDI syncs to the system tempo; 40-240 sets the tempo manually for this individual effect. p.846.

When **BPM** is set to MIDI, the minimum tempo is 44BPM.

Rhythm Pattern $Rhythm Pattern$ [♪...♪♪♪3]

This parameter automatically creates rhythmic patterns by controlling the tap delay times and turning individual taps on and off. You can customize the patterns by using the feedback amount and per-tap pan controls, below.

The feedback time is always a quarter-note.

Tap1 Pan [L, 1...99, R]

Sets the panning of Tap1.

Tap2 Pan [L, 1...99, R]

Sets the panning of Tap2.

Tap3 Pan [L, 1...99, R]

Sets the panning of Tap3.

Tap4 Pan [L, 1...99, R]

Sets the panning of Tap4.

Feedback D_{mod} [+/-100]

Sets the feedback amount. Negative values invert the phase.

Source [Off...Tempo]

Selects a Dmod source to modulate **Feedback**.

Amount [+/-100]

Sets the modulation amount for **Feedback**.

091: L/C/R BPM Delay

The L/C/R delay enables you to match the delay time with the song tempo. You can also synchronize the delay time with the arpeggiator or sequencer. If you program the tempo before performance, you can achieve a delay effect that synchronizes with the song in real-time. Delay time is set by notes.

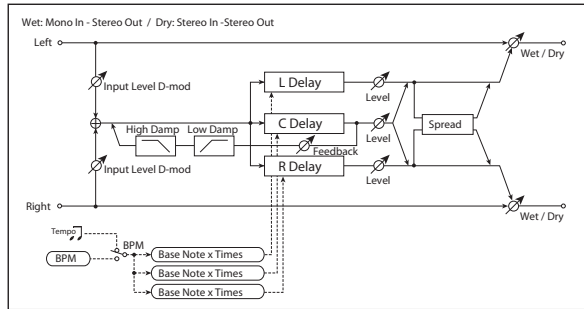

INPUT

Input Level Dmod [%] **[+/-100]**

Sets the modulation amount of the input level. p.825.

Source **[Off...Tempo]**

Selects the modulation source for the input level. p.825.

DELAY

BPM **[MIDI, 40.00...300.00]**

MIDI syncs to the system tempo; 40-240 sets the tempo manually for this individual effect.

Time Over?> **[---, OVER!]**

The maximum delay time is 2,730msec. If the combination of **BPM**, **Base Note**, and **Times** exceeds this limit, the error message “OVER!” appears in the display. If this occurs, change the delay time parameters so that this message no longer appears.

L Delay Base Note **[♪...]**

This sets the basic length of the Left Delay, relative to the BPM setting. The values range from a 32nd note to a whole note, including triplets.

Times **[x1...x32]**

This multiplies the length of the Base Note. For instance, if the Base Note is set to a sixteenth note, and Times is set to 3, the delay length will be a dotted eighth note.

Level **[0...50]**

Sets the output level of the Left Delay.

C Delay Base Note **[♪...]**

This sets the basic length of the Center Delay, relative to the BPM setting.

Times **[x1...x32]**

This multiplies the length of the Center Delay’s Base Note.

Level **[0...50]**

Sets the output level of the Center Delay.

R Delay Base Note **[♪...]**

This sets the basic length of the Right Delay, relative to the BPM setting.

Times **[x1...x32]**

This multiplies the length of the Right Delay’s Base Note.

Level **[0...50]**

Sets the output level of the Right Delay.

Feedback (C Delay) **[+/-100]**

Sets the amount of feedback from the Center Delay.

Source **[Off...Tempo]**

Selects the modulation source for the Center Delay feedback.

Amount **[+/-100]**

Sets the modulation amount of the Center Delay feedback.

High Damp [%] **[0...100]**

Sets the amount of high-frequency attenuation for the feedback path.

Low Damp [%] **[0...100]**

Sets the amount of low-frequency attenuation for the feedback path.

Spread **[0...50]**

Sets the width of the stereo image of the effect sound. For more information, see “Spread” on page 835.

OUTPUT

This is the standard effects output section, with modulatable control over wet/dry balance. For more information, see “OUTPUT” on page 764.

092: L/C/R BPM Long Delay

The L/C/R delay enables you to match the delay time with the song tempo. You can set the delay time up to 5,460msec

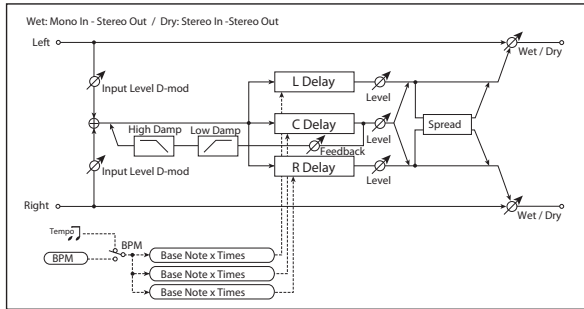

INPUT

Input Level Dmod [%] **[+/-100]**

Sets the modulation amount of the input level. p.825.

Source **[Off...Tempo]**

Selects the modulation source for the input level. p.825.

DELAY

BPM **[MIDI, 40.00...300.00]**

MIDI syncs to the system tempo; 40-240 sets the tempo manually for this individual effect.

Time Over?> **[---, OVER!]**

The maximum delay time is 5,460msec. If the combination of **BPM**, **Base Note**, and **Times** exceeds this limit, the error message “OVER!” appears in the display. If this occurs, change the delay time parameters so that this message no longer appears.

L Delay Base Note **[]**

This sets the basic length of the Left Delay, relative to the BPM setting. The values range from a 32nd note to a whole note, including triplets.

Times **[x1...x32]**

This multiplies the length of the Base Note. For instance, if the Base Note is set to a sixteenth note, and Times is set to 3, the delay length will be a dotted eighth note.

Level **[0...50]**

Sets the output level of the Left Tap.

C Delay Base Note **[]**

This sets the basic length of the Center Delay, relative to the BPM setting.

Times **[x1...x32]**

This multiplies the length of the Center Delay’s Base Note.

Level **[0...50]**

Sets the output level of the Center Delay.

R Delay Base Note **[]**

This sets the basic length of the Right Delay, relative to the BPM setting.

Times **[x1...x32]**

This multiplies the length of the Right Delay’s Base Note.

Level **[0...50]**

Sets the output level of the Right Delay.

Feedback (C Delay) **[+/-100]**

Sets the feedback amount of the Center Delay.

Source **[Off...Tempo]**

Selects a source to modulate the Center Delay feedback.

Amount **[+/-100]**

Sets the Center Delay feedback modulation amount.

High Damp [%] **[0...100]**

Sets the amount of high-frequency attenuation for the feedback path.

Low Damp [%] **[0...100]**

Sets the amount of low-frequency attenuation for the feedback path.

Spread **[0...50]**

Sets the width of the stereo image of the effect sound. For more information, see “Spread” on page 835.

OUTPUT

This is the standard effects output section, with modulatable control over wet/dry balance. For more information, see “OUTPUT” on page 764.

093: Stereo BPM Delay

This stereo delay enables you to set the delay time to match the song tempo. Fine adjustment lets you change the rhythmic feel of the delays.

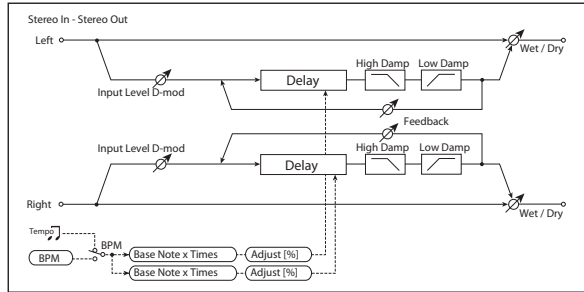

INPUT

Input Level Dmod [%] **[+/-100]**

Sets the modulation amount for the input level. For more information, see “Input Level Dmod [%]” on page 825.

Source **[Off...Tempo]**

Selects the modulation source for the input level.

DELAY

BPM **[MIDI, 40.00...300.00]**

MIDI syncs to the system tempo; 40-240 sets the tempo manually for this individual effect.

Time Over? L > **[---, OVER!]**

Time Over? R > **[---, OVER!]**

The maximum delay time is 1,360msec per channel (left and right). If the channel’s combination of **BPM**, **Base Note**, and **Times** exceeds this limit, the error message “OVER!” will appear. If this occurs, change the delay time parameters so that this message no longer appears.

L Delay Base Note **[♪...♩]**

This sets the basic length of the Left Delay, relative to the BPM setting. The values range from a 32nd note to a whole note, including triplets.

Times **[x1...x32]**

This multiplies the length of the Base Note. For instance, if the Base Note is set to a sixteenth note, and Times is set to 3, the delay length will be a dotted eighth note.

Adjust [%] **[-2.50...+2.50]**

This adjusts the left channel delay time by up to 2.5% in either direction, for subtle control over the feel of the delay.

R Delay Base Note **[♪...♩]**

This sets the basic length of the Right Delay, relative to the BPM setting.

Times **[x1...x32]**

This multiplies the length of the Right Delay’s Base Note.

Adjust [%] **[-2.50...+2.50]**

Fine-adjust the right channel delay time.

L Feedback **[+/-100]**

Sets the feedback amount for the left channel.

R Feedback **[+/-100]**

Sets the feedback amount for the right channel.

Source **[Off...Tempo]**

Selects the modulation source of feedback amount.

L Amount **[+/-100]**

Sets the modulation amount of the left channel feedback.

R Amount **[+/-100]**

Sets the modulation amount of the right channel feedback.

High Damp [%] **[0...100]**

Sets the amount of high-frequency attenuation for the feedback path.

Low Damp [%] **[0...100]**

Sets the amount of low-frequency attenuation for the feedback path.

OUTPUT

This is the standard effects output section, with modulatable control over wet/dry balance. For more information, see “OUTPUT” on page 764.

094: Stereo BPM Long Delay

The stereo delay enables you to match the delay time with the song tempo. You can set the delay time up to 2,730msec.

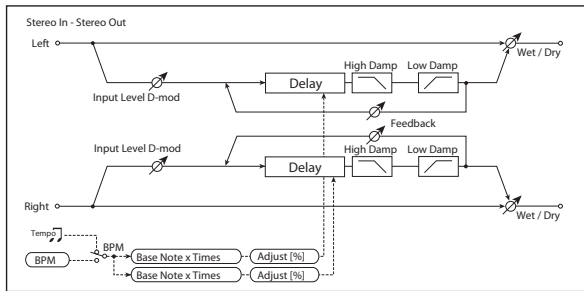

INPUT

Input Level Dmod [%] **[+/-100]**

Sets the modulation amount for the input level. For more information, see “Input Level Dmod [%]” on page 825.

Source **[Off...Tempo]**

Selects the modulation source for the input level.

DELAY

BPM **[MIDI, 40.00...300.00]**

MIDI syncs to the system tempo; 40-240 sets the tempo manually for this individual effect.

Time Over? L > **[---, OVER!]**

Time Over? R > **[---, OVER!]**

The maximum delay time is 2,730msec per channel (left and right). If the channel’s combination of **BPM**, **Base Note**, and **Times** exceeds this limit, the error message “OVER!” will appear. If this occurs, change the delay time parameters so that this message no longer appears.

L Delay Base Note **[]**

This sets the basic length of the Left Delay, relative to the BPM setting. The values range from a 32nd note to a whole note, including triplets.

Times **[x1...x32]**

This multiplies the length of the Base Note. For instance, if the Base Note is set to a sixteenth note, and Times is set to 3, the delay length will be a dotted eighth note.

Adjust [%] **[-2.50...+2.50]**

This adjusts the left channel delay time by up to 2.5% in either direction, for subtle control over the feel of the delay.

R Delay Base Note **[]**

This sets the basic length of the Right Delay, relative to the BPM setting.

Times **[x1...x32]**

This multiplies the length of the Right Delay’s Base Note.

Adjust [%] **[-2.50...+2.50]**

Fine-adjust the right channel delay time.

L Feedback **[+/-100]**

Sets the feedback amount for the left channel.

R Feedback **[+/-100]**

Sets the feedback amount for the right channel.

Source **[Off...Tempo]**

Selects the modulation source of feedback amount.

L Amount **[+/-100]**

Sets the modulation amount of the left channel feedback.

R Amount **[+/-100]**

Sets the modulation amount of the right channel feedback.

High Damp [%] **[0...100]**

Sets the damping amount in the high range. For more information, see “High Damp [%]” on page 835.

Low Damp [%] **[Korg0...100]**

Sets the damping amount in the low range. For more information, see “Low Damp [%]” on page 835.

OUTPUT

This is the standard effects output section, with modulatable control over wet/dry balance. For more information, see “OUTPUT” on page 764.

095: Stereo BPM Multitap Delay

This four-tap delay enables you to select a tempo and rhythm pattern to set up each tap.

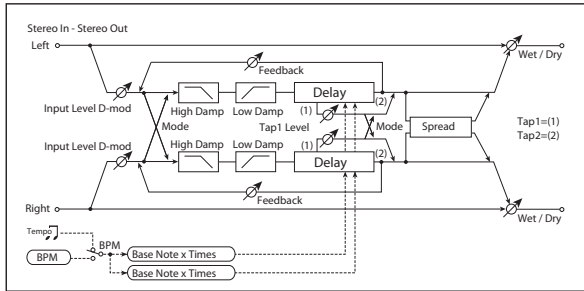

INPUT

Input Level Dmod [%] **[+/-100]**

Sets the modulation amount for the input level. For more information, see “Input Level Dmod [%]” on page 825.

Source **[Off...Tempo]**

Selects the modulation source for the input level.

DELAY

BPM **[MIDI, 40.00...300.00]**

MIDI syncs to the system tempo; 40-240 sets the tempo manually for this individual effect.

Time Over?> **[---, OVER!]**

The maximum delay time is 1,360msec. If the combination of **BPM**, **Base Note**, and **Times** exceeds this limit, the error message “OVER!” will appear. If this occurs, change the delay time parameters so that this message no longer appears.

Mode **[Normal, Cross Feedback, Cross Pan1, Cross Pan2]**

Switches the left and right delay routing. For more information, see “Mode” on page 837.

Tap 1 Base Note **[♪...]**

This sets the basic length of the Tap 1, relative to the BPM setting. The values range from a 32nd note to a whole note, including triplets.

Times **[x1...x32]**

This multiplies the length of the Base Note. For instance, if the Base Note is set to a sixteenth note, and Times is set to 3, the delay length will be a dotted eighth note.

Tap 2 Base Note **[♪...]**

This sets the basic length of Tap 2, relative to the BPM setting.

Times **[x1...x32]**

This multiplies the length of Tap 2’s Base Note.

Feedback (Tap2) **[+/-100]**

Sets the Tap 2 feedback amount.

Source **[Off...Tempo]**

Selects the modulation source of the Tap 2 feedback amount.

Amount **[+/-100]**

Sets the modulation amount of the Tap 2 feedback amount.

Tap1 Level **[0...100]**

Sets the Tap1 output level. For more information, see “Tap1 Level” on page 838.

High Damp [%] **[0...100]**

Sets the amount of high-frequency attenuation.

Low Damp [%] **[0...100]**

Sets the amount of low-frequency attenuation.

Spread **[+/-100]**

Sets the width of the stereo image of the effect sound. For more information, see “Spread” on page 835.

Source **[Off...Tempo]**

Selects the modulation source of the effect sound’s stereo image width.

Amount **[+/-100]**

Sets the modulation amount of the effect sound’s stereo image width.

OUTPUT

This is the standard effects output section, with modulatable control over wet/dry balance. For more information, see “OUTPUT” on page 764.

096: Stereo BPM Mod. Delay

This stereo tempo delay uses either an LFO or a Dmod source to modulate the delay time. This causes the delay's pitch to vary, creating an effect which swells and shimmers like a cross between an echo and a chorus.

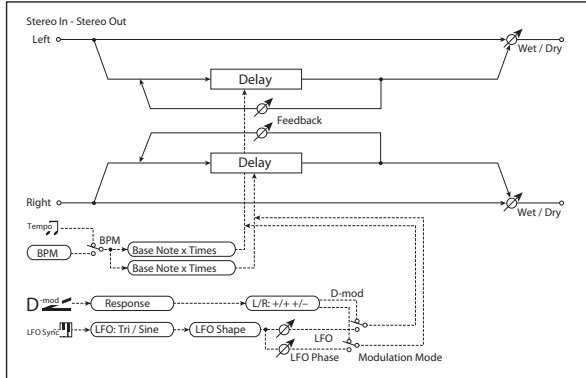

CONTROL

Modulation Mode [LFO, Dmod]

This selects whether the delay time will be swept by the LFO or by the selected Dmod source.

Dmod Modulation [L/R: +/+, L/R: +/-]

This applies only if **Modulation Mode** is set to **Dmod**.

L/R: +/+: the Dmod source modulates both left and right delays equally.

L/R: +/-: the Dmod source modulates left and right inversely, for a deeper stereo effect.

Source [Off...Tempo]

Selects a modulation source to control the delay time. This applies only if **Modulation Mode** is set to **Dmod**.

Response [0...30]

This controls how quickly the delay times change in response to the modulation source. Higher values mean faster response times.

LFO

All of the LFO controls apply only when the **Modulation Mode** is set to **LFO**.

Waveform [Triangle, Sine]

Selects the LFO Waveform.

Shape [+/-100]

Changes the curvature of the LFO Waveform. For more information, see "Shape" on page 784.

L LFO Phase [degrees] [-180...+180]

This sets the initial phase of the left LFO. The relationship between this and the **R LFO Phase** controls the depth of the stereo effect and the richness of the pitch changes. As a start, try setting one to +90 and the other to -90.

R LFO Phase [degrees] [-180...+180]

This sets the initial phase of the right LFO.

Dmod Sync [Check-box]

This enables reset of the LFOs from a Dmod source, as selected below.

Source [Off...Tempo]

If **Dmod Sync** is **On**, this selects the modulation source to reset the LFOs, using the initial phases set by **L LFO Phase** and **R LFO Phase** above.

For example, if you set the **Source** to **Gate 2**, playing on the keyboard will reset the LFOs so that the modulation sounds the same at the start of each phrase.

MIDI The LFOs are reset when the modulation value changes from 63 or smaller to 64 or higher.

Frequency [Hz] [0.02...20.00]

This sets the LFO speed, in Hz. It applies only when **MIDI/Tempo Sync**, below, is **Off**.

MIDI/Tempo Sync [Check-box]

BPM [MIDI, 40.00...300.00]

Base Note [Musical Notation]

Times [x1...x32]

When **MIDI/Tempo Sync** is on, the LFO speed is set by **BPM**, **Base Note**, and **Times**, instead of **Frequency**. For more information, see "MIDI/Tempo Sync" on page 781.

Type [Individual, Common1, Common2]

This controls whether the effect uses its individual LFO, or one of the Common FX LFOs. For more information, see "LFO Type" on page 781.

Common LFO Phase Offset [degrees] [+/-180]

When Type is set to **Common FX LFO 1** or **2**, this lets you offset the phase from the master LFO.

MOD DELAY

BPM [MIDI, 40.00...300.00]

MIDI syncs to the system tempo; 40-240 sets the tempo manually for this individual effect.

Time Over? L > [---, OVER!]

Time Over? R > [---, OVER!]

The maximum delay time is 1,000msec per channel (left and right). If the channel's combination of **BPM**, **Base Note**, and **Times** exceeds this limit, the error message "OVER!" will appear. If this occurs, change the delay time parameters so that this message no longer appears.

L Delay Base Note [Musical Notation]

This sets the basic length of the Left Delay, relative to the BPM setting. The values range from a 32nd note to a whole note, including triplets.

Times [x1...x32]

This multiplies the length of the Base Note. For instance, if the Base Note is set to a sixteenth note, and Times is set to 3, the delay length will be a dotted eighth note.

R Delay Base Note  [♩...♩]

This sets the basic length of the Right Delay, relative to the BPM setting.

Times [x1...x32]

This multiplies the length of the Right Delay's Base Note.

L Depth [0...200]

Sets the amount of pitch modulation for the left channel. 0...100 produce chorus-like effects; over 100 produces more obvious pitch-shifting.

R Depth [0...200]

Sets the amount of pitch modulation for the right channel.

L Feedback [+/-100]

Sets the amount of feedback for the left delay. Negative values invert the phase.

R Feedback [+/-100]

Sets the amount of feedback for the right delay.

OUTPUT

This is the standard effects output section, with modulatable control over wet/dry balance. For more information, see "OUTPUT" on page 764.

097: St. BPM Auto Panning Dly

This stereo auto panning delay enables you to set the delay time to match the song tempo.

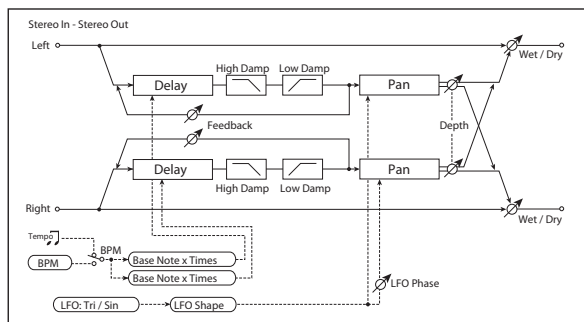

DELAY

BPM  [MIDI, 40.00...300.00]

MIDI syncs to the system tempo; 40-240 sets the tempo manually for this individual effect.

Time Over? L > [---, OVER!]

Time Over? R > [---, OVER!]

The maximum delay time is 1,360msec per channel (left and right). If the channel's combination of **BPM**, **Base Note**, and **Times** exceeds this limit, the error message "OVER!" will appear. If this occurs, change the delay time parameters so that this message no longer appears.

L Delay Base Note  [♩...♩]

This sets the basic length of the Left Delay, relative to the BPM setting. The values range from a 32nd note to a whole note, including triplets.

Times [x1...x32]

This multiplies the length of the Base Note. For instance, if the Base Note is set to a sixteenth note, and Times is set to 3, the delay length will be a dotted eighth note.

R Delay Base Note  [♩...♩]

This sets the basic length of the Right Delay, relative to the BPM setting.

Times [x1...x32]

This multiplies the length of the Right Delay's Base Note.

L Feedback [+/-100]

Sets the feedback amount for the left channel.

R Feedback [+/-100]

Sets the feedback amount for the right channel.

High Damp [%] [0...100]

Sets the amount of high-frequency attenuation.

Low Damp [%] [0...100]

Sets the amount of low-frequency attenuation.

LFO

Waveform [Triangle, Sine]

Selects the LFO Waveform.

Shape [+/-100]

Changes the curvature of the LFO Waveform. For more information, see "Shape" on page 784.

Phase [degrees] [-180...+180]

Sets the LFO phase difference between the left and right. For more information, see "Phase [degrees]" on page 819.

Frequency [Hz]  [0.02...20.00]

This sets the LFO speed, in Hz. It applies only when **MIDI/Tempo Sync**, below, is **Off**.

MIDI/Tempo Sync  [Check-box]

BPM [MIDI, 40.00...300.00]

Base Note [♩...♩]

Times [x1...x32]

When **MIDI/Tempo Sync** is on, the LFO speed is set by **BPM**, **Base Note**, and **Times**, instead of **Frequency**. For more information, see "MIDI/Tempo Sync" on page 781.

Type [Individual, Common1, Common2]

This controls whether the effect uses its individual LFO, or one of the Common FX LFOs. For more information, see "LFO Type" on page 781.

Common LFO Phase Offset [degrees] [+/-180]

When Type is set to **Common FX LFO 1** or **2**, this lets you offset the phase from the master LFO.

AUTO PAN

Depth  [0...100]

Sets the panning width.

Source [Off...Tempo]

Selects the modulation source for the panning width.

098: Tape BPM Echo

This models a tape echo unit with three playback heads—but with the ability to sync to tempo. The distortion and tonal changes typical of magnetic tape are also reproduced.

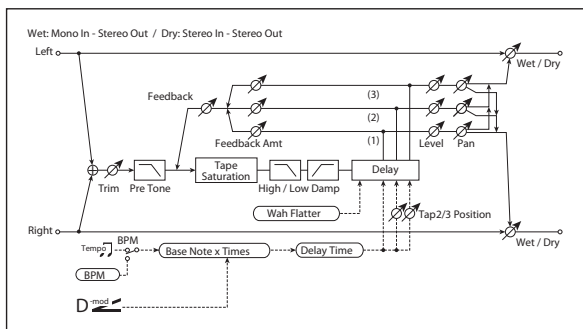

INPUT

Trim [0...100]

Sets the input gain.

Pre Tone [0...100]

This models the reduced high frequencies of an analog tape delay, before the saturation stage. Lower settings create a darker tone.

WOW & FLUTTER

This section models the instability of the tape machine's motors. As the speed of the motor fluctuates, the pitch changes slightly. This introduces a pleasant chorus-like effect.

Frequency [Hz] [0.02...1.00]

Sets the frequency at which pitch variation occurs.

Depth [0...100]

Sets the depth of the pitch change.

TAPE ECHO

Delay Time

BPM  [MIDI, 40.00...300.00]

MIDI syncs to the system tempo; 40-240 sets the tempo manually for this individual effect. p.827.

Amount [+/-100]

Set the modulation amount of the panning width.

OUTPUT

This is the standard effects output section, with modulatable control over wet/dry balance. For more information, see "OUTPUT" on page 764.

Time Over? > [---, OVER!]

The maximum delay time is 2,700msec. If the combination of **BPM**, **Base Note**, and **Times** exceeds this limit, the error message "OVER!" will appear. If this occurs, change the delay time parameters so that this message no longer appears.

Delay(Tap1) Note  []

This sets the basic delay time of Tap 1, relative to the system tempo. The values range from a 32nd note to a whole note, including triplets.

Also, Taps 2 and 3 are specified as a percentage (%) of this delay time. Taps 2 and 3 always stay in proportion to Tap 1, even when the delay time is modulated.

Times [x1...x32]

This multiplies the length of the Base Note. For instance, if the Base Note is set to a sixteenth note, and Times is set to 3, the delay time will be a dotted eighth note.

Source [Off...Tempo]

Selects the modulation source for the delay **Note** and **Times**.

Dmod Max Note  []

Instead of specifying a modulation intensity, you can specify a note (and multiplier) to map to the maximum modulation value. Note that these can each be either longer or shorter than the original **Note** and **Times**.

Times [x1...x32]

This sets the multiplier for the **Dmod Max Note**.

Tap2 Position [%] [0...100]

Sets the delay time of Tap 2, as a percentage of Tap 1's delay time.

Tap3 Position [%] [0...100]

Sets the delay time of Tap 3, as a percentage of Tap 1's delay time.

Level and Pan 1...3

Each tap has its own controls for level and pan.

Tap1...3 Level [0...100]

Sets the tap's output level.

Pan [L, 1...99, R]

Sets the tap's stereo position.

Feedback

Tap1...3 Feedback Amount [+/-100]

Sets the individual tap's feedback level. Negative values invert the phase. These individual levels are summed together, and then the final level is controlled by **Feedback Level**, below.

Feedback Level D_{mod} [0...100]

Sets the overall level of feedback.

Source [Off...Tempo]

Selects the modulation source for the **Feedback Level**.

Amount [+/-100]

Sets the modulation amount for the **Feedback Level**.

Tone

High Damp [%] [0...100]

This cuts the high frequencies in both the main output and the feedback. Higher settings create a darker tone.

Low Damp [%] [0...100]

This cuts the low frequencies in both the main output and the feedback. Higher settings mean less low-end.

Saturation [0...100]

This models the distortion of an analog tape delay.

OUTPUT

This is the standard effects output section, with modulatable control over wet/dry balance. For more information, see "OUTPUT" on page 764.

099: Reverse BPM Delay

This is a reverse-playback delay that lets you synchronize the delay time to the tempo of the song.

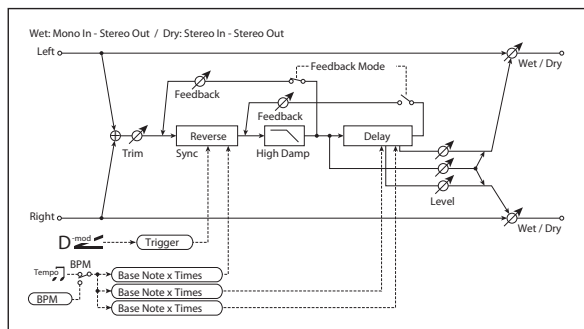

INPUT

Input Level Dmod [%] D_{mod} [+/-100]

Sets the modulation amount of the input level.

Source [Off...Tempo]

Selects the modulation source for the input level.

REVERSE DELAY

BPM A_{sync} [MIDI, 40.00...300.00]

MIDI syncs to the system tempo; 40-240 sets the tempo manually for this individual effect.

Time Over? > [---, OVER!]

The maximum delay time is 900msec. If the combination of **BPM**, **Base Note**, and **Times** exceeds this limit, the error message "OVER!" will appear. If this occurs, change the delay time parameters so that this message no longer appears.

Reverse Base Note A_{sync} [♪...]

This sets the basic length of the Reverse Delay, relative to the BPM setting. The values range from a 32nd note to a whole note, including triplets.

Times [x1...x32]

This multiplies the length of the Base Note. For instance, if the Base Note is set to a sixteenth note, and Times is set to 3, the delay length will be a dotted eighth note.

Level [0...100]

Sets the output level of the reverse playback.

R Delay Base Note A_{sync} [♪...]

This sets the basic length of the Right Delay, relative to the BPM setting.

Times [x1...x32]

This multiplies the length of the Right Delay's Base Note.

L Post-Delay Base Note A_{sync} [♪...]

This sets the basic length of the Left Post-Delay, relative to the BPM setting.

Times [x1...x32]

This multiplies the length of the Left Post-Delay's Base Note.

Level [0...100]

Sets the output level of the Left Post-Delay.

R Post-Delay Base Note A_{sync} [♪...]

This sets the basic length of the Right Post-Delay, relative to the BPM setting.

Times [x1...x32]

This multiplies the length of the Right Post-Delay's Base Note.

Level [0...100]

Sets the output level of the Right Post-Delay.

Feedback Mode [Reverse, Reverse/Forward]

Selects the feedback mode: reverse playback, or alternating reverse and forward playback. For more information, see "Feedback Mode" on page 843.

Feedback D_{mod} [+/-100]

Sets the feedback amount.

Source [Off...Tempo]

Selects the modulation source of feedback amount.

Amount [+/-100]

Sets the feedback amount.

High Damp [%] [0...100]

Sets the amount of high-frequency attenuation.

Sync Source  [Off...Tempo]

Selects the modulation source that will reset the point at which the sound is captured for reverse playback. For more information, see “Reverse Time and Sync Source” on page 843.

OUTPUT

This is the standard effects output section, with modulatable control over wet/dry balance. For more information, see “OUTPUT” on page 764.

Reverb and Early Reflections

100: Overb

The Overb features a high-quality, diffusion-based reverb core. In addition to setting the size of the room, you can model its shape and materials by adjusting the diffusion characteristics of both the initial reflections and the main reverberant wash, and via separate controls for the high, mid, and low decay times. The Overb also includes randomization, for richer and smoother reverb timbres.

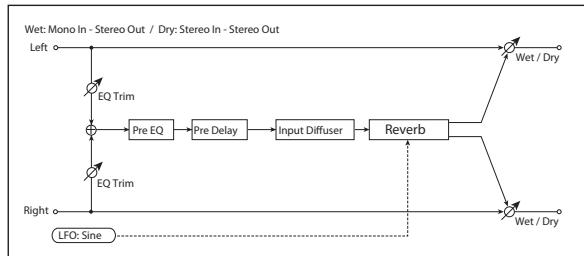

Pre EQ

There are two fully parametric bands of peaking EQ, for adjusting the reverb timbre. These affect only the reverb, and not the dry signal. Both bands have identical parameters.

Trim [0...100]

Sets the EQ input level.

Band 1

Band1 [Check-box]

Switches the first band of EQ band on and off.

Fc [Hz] [200...20.00k]

Sets the center frequency of Band 1.

Q [0.5...10.0]

Sets the bandwidth of Band 1.

Gain [dB] [-18.0...+18.0]

Sets the gain of Band 1.

Band 2

Band 2 has the same parameters as Band 1, above.

Rolloff

Rolloff [0...100]

This controls a lowpass filter on the output of the effect. Settings around 6-8kHz are good for producing a warm, smooth sound.

REVERB

Pre Delay [msec] [0...1360]

Sets the delay time from the dry sound.

Diffusion1 [0...100]

Diffusion 1 and **2** soften the sound before it enters the reverb core, shaping the timbre of the initial reflections. Setting both diffusers to around 50 generally produces sufficient diffusion for smooth reverbs; extremely high levels may cause ringing.

Some source material, such as vocals, may also benefit from lower settings of diffusion, allowing for more discrete echoes.

Diffusion1 and **Diffusion2** differ in how the reflections are spaced, and the balance between these two parameters will vary the character of the reverb.

Diffusion2 [0...100]

This is the second diffuser for the initial reflections. For more information, see “Diffusion1,” above.

Size [5...100]

Sets the size of the space.

Time [0...100]

This sets the main reverberation time. The **Damping** and (bass) **Gain** parameters, below, let you adjust the decay times separately for the high and low frequencies, respectively.

Diffusion [0...100]

This sets the density of reflections within the main reverb. Low settings will produce more discrete echoes, and high settings will produce a smoother reverb. Extremely high settings may cause ringing.

Reverb Size, Time, and Diffusion

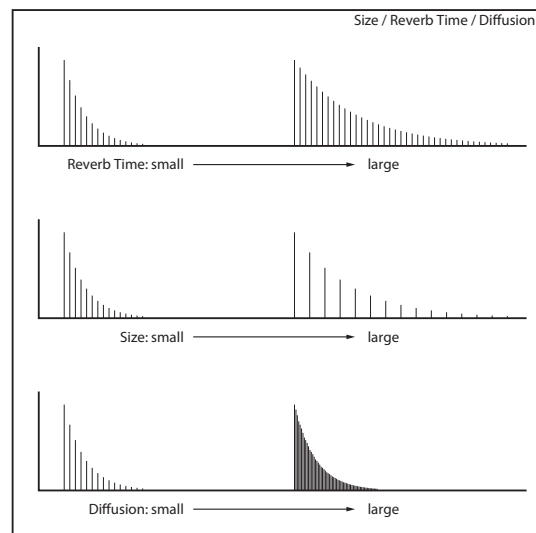

Damping [0...100]

This sets the cutoff of the high-frequency damping filter. If **Damping** is set to **100**, the high frequencies will decay at the same rate as the low frequencies; at **0**, the high frequencies will decay almost instantly.

In real acoustic spaces, high frequencies generally delay somewhat faster than low frequencies, so moderate amounts of damping will create a more realistic sound.

Bass Crossover [Hz] [20...24.00k]

Sets the crossover frequency for the Bass Gain.

Gain [dB] [-12.0...+6.0]

This lets you tailor the decay time of the reverb's low frequencies, using the frequency set by the Bass Crossover. Negative settings make the low frequencies decay faster than the main reverb; positive settings make them decay more slowly.

MODULATION

Rate [0.02...5.00]

The O-Verb includes randomization in the reverberant wash, to diminish resonant peaks and add a rich character to the sound. The **Rate** determines the speed of the randomization.

Depth [0...100]

This determines the intensity of the randomization.

OUTPUT

This is the standard effects output section, with modulatable control over wet/dry balance. For more information, see "OUTPUT" on page 764.

101: Reverb Hall

This hall-type reverb simulates the reverberation of mid-size concert halls or ensemble halls. For detailed explanations of the parameters, see "104: Reverb Dry Plate," below.

102: Reverb Smooth Hall

This hall-type reverb simulates the reverberation of larger halls and stadiums, and creates a smooth release. For detailed explanations of the parameters, see "104: Reverb Dry Plate," below.

103: Reverb Wet Plate

This plate reverb creates warm, dense reverberation. For detailed explanations of the parameters, see "104: Reverb Dry Plate," below.

104: Reverb Dry Plate

This plate reverb creates dry, light reverberation.

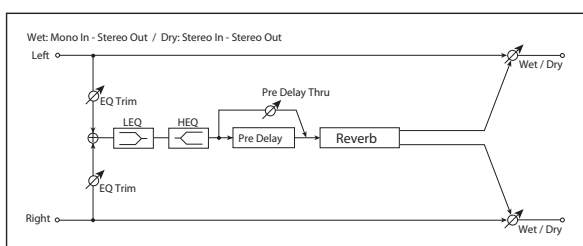

Pre EQ

Trim [0...100]

Sets the EQ input level.

LEQ Fc [Low, Mid-Low]

Selects the cutoff frequency (low or mid-low) of the low-range equalizer.

LEQ Gain [dB] [-15.0...+15.0]

Sets the gain of the Low EQ.

HEQ Fc [High, Mid-High]

Selects the cutoff frequency (high or mid-high) of the high-range equalizer.

HEQ Gain [dB] [-15.0...+15.0]

Sets the gain of the High EQ.

REVERB

Reverb Time [sec] [0.1...10.0]

Sets the reverberation time.

High Damp [%] [0...100]

Sets the amount of high-frequency attenuation.

Pre Delay [msec] [0...200]

The **Pre Delay** is not heard directly; it only affects the signal going to the reverb. Higher amounts of **Pre Delay** enhance the feeling of spaciousness, allowing the reverb to blossom a little after the initial sound.

Pre Delay Thru [%] [0...100]

The un-delayed input is mixed together with the **Pre Delay** output, and the result is fed into the reverb. **Pre Delay Thru** controls the level of the un-delayed input (the **Pre Delay** level is always at maximum). The mix of the delayed and un-delayed signals can create a more dense, natural timbre.

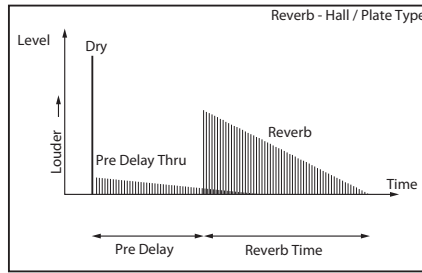

OUTPUT

This is the standard effects output section, with modulatable control over wet/dry balance. For more information, see “OUTPUT” on page 764.

105: Reverb Room

This room-type reverb emphasizes the early reflections that make the sound tighter. Changing the balance between the early reflections and reverb sound allows you to simulate

nuances, such as the type of walls of a room. For detailed explanations of the parameters, see “106: Reverb Bright Room” on page 859.

106: Reverb Bright Room

This room-type reverb emphasizes the early reflections that make the sound brighter. See 056: Reverb Room.

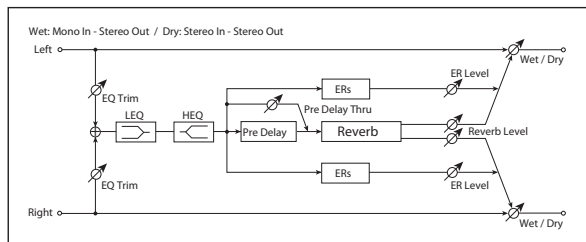

Pre Delay [msec] [0...200]

Sets the delay time from the dry sound. p.858.

Pre Delay Thru [%] [0...100]

Sets the mix ratio of non-delay sound. p.859.

ER Level [0...100]

Sets the level of early reflections. See “Reverb Level,” below.

Reverb Level [0...100]

Sets the level of the main reverberation.

Together, the **ER Level** and **Reverb Level** allow you to model the type of walls in the room. A larger **ER Level** simulates a hard wall, and a larger **Reverb Level** simulates a soft wall.

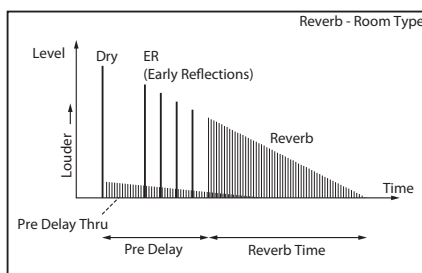

OUTPUT

This is the standard effects output section, with modulatable control over wet/dry balance. For more information, see “OUTPUT” on page 764.

Pre EQ

Trim [0...100]

Sets the EQ input level.

LEQ Fc [Low, Mid-Low]

Selects the cutoff frequency (low or mid-low) of the low-range equalizer.

LEQ Gain [dB] [-15.0...+15.0]

Sets the gain of the Low EQ.

HEQ Fc [High, Mid-High]

Selects the cutoff frequency (high or mid-high) of the high-range equalizer.

HEQ Gain [dB] [-15.0...+15.0]

Sets the gain of the High EQ.

REVERB

Reverb Time [sec] [0.1...3.0]

Sets the reverberation time.

High Damp [%] [0...100]

Sets the amount of high-frequency attenuation.

107: Early Reflections

This effect is only the early reflection part of a reverberation sound, and adds presence to the sound. You can select one of the four decay curves.

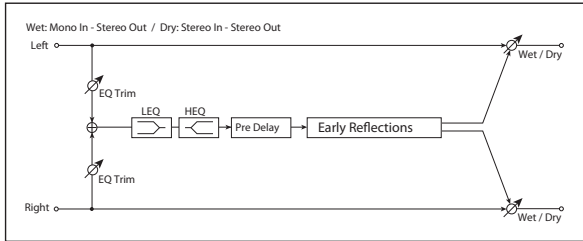

Pre EQ

Trim [0...100]

Sets the input level of EQ applied to the effect sound.

LEQ Fc [Low, Mid-Low]

Selects the cutoff frequency (low or mid-low) of the low-range equalizer.

LEQ Gain [dB] [-15.0...+15.0]

Sets the gain of the Low EQ.

HEQ Fc [High, Mid-High]

Selects the cutoff frequency (high or mid-high) of the high-range equalizer.

HEQ Gain [dB] [-15.0...+15.0]

Sets the gain of the High EQ.

EARLY REFLECTIONS

Pre Delay [msec] [0...200]

Sets the time taken from the original sound to the first early reflection.

Type [Sharp, Loose, Modulated, Reverse]

This parameter selects the decay curve for the early reflections.

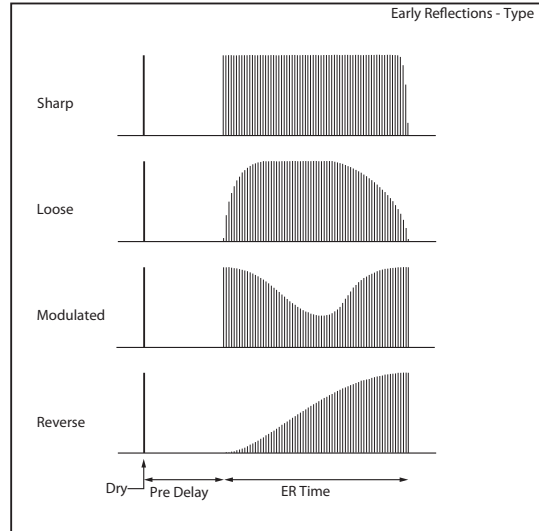

ER Time [msec] [10...800]

Sets the time length of early reflection.

OUTPUT

This is the standard effects output section, with modulatable control over wet/dry balance. For more information, see "OUTPUT" on page 764.

108: Early Reflections Hi Dens

This early reflection effect has more precise early reflections with twice the maximum length of 107: Early Reflections. You can create a very smooth and dense sound.

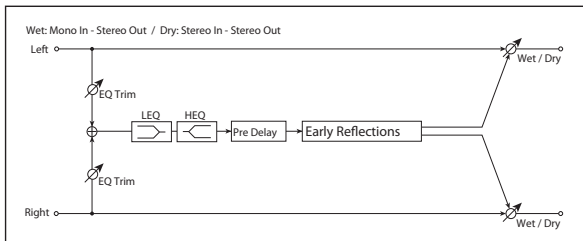

Pre EQ

Trim [0...100]

Sets the input level of EQ applied to the effect sound.

LEQ Fc [Low, Mid-Low]

Selects the cutoff frequency (low or mid-low) of the low-range equalizer.

LEQ Gain [dB] [-15.0...+15.0]

Sets the gain of the Low EQ.

HEQ Fc [High, Mid-High]

Selects the cutoff frequency (high or mid-high) of the high-range equalizer.

HEQ Gain [dB] [-15.0...+15.0]

Sets the gain of the High EQ.

EARLY REFLECTIONS

Pre Delay [msec] [0...200]

Sets the time taken from the original sound to the first early reflection.

Type [Sharp, Loose, Modulated, Reverse]

Selects the decay curve for the early reflections. For more information, see “Type” on page 860.

ER Time [msec] [10...1600]

Sets the time length of early reflection.

OUTPUT

This is the standard effects output section, with modulatable control over wet/dry balance. For more information, see “OUTPUT” on page 764.

Mono-Mono Serial

109: P4EQ - Exciter through 140: Reverb - Gate provide serial chains of mono effects. These include various combinations of EQ, Compressor, Limiter, Exciter, Overdrive, Wah, Chorus/Flanger, Phaser, Multitap Delay, Gate, and Reverb, as described below.

PARAMETRIC EQ

For a description of the on-screen EQ graphic, see “011: Stereo Parametric 4EQ” on page 776.

Trim [0...100]

Sets the parametric EQ input level.

Band1 Fc [Hz] [20...1.00k]

Sets the center frequency of Band 1.

Q [0.5...10.0]

Sets the bandwidth of Band 1. For more information, please see “Q” on page 776.

Gain [dB] [-18...+18]

Sets the gain of Band 1.

Band2 Fc [Hz] [50...5.00k]

Sets the center frequency of Band 2.

Q [0.5...10.0]

Sets the bandwidth of Band 2.

Gain [dB] [-18...+18]

Sets the gain of Band 2.

Band3 Fc [Hz] [300...10.00k]

Sets the center frequency of Band 3.

Q [0.5...10.0]

Sets the bandwidth of Band 3.

Gain [dB] [-18...+18]

Sets the gain of Band 3.

Band4 Fc [Hz] [500...20.00k]

Sets the center frequency of Band 4.

Q [0.5...10.0]

Sets the bandwidth of Band 4.

Gain [dB] [-18...+18]

Sets the gain of Band 4.

EXCITER

Emphasis Frequency [0...70]

Sets the frequency range to be emphasized. For more information, see “Emphasis Frequency” on page 779.

Exciter Blend [+/-100]

Sets the intensity (depth) of the Exciter effect. For more information, see “Blend” on page 779.

MULTITAP DELAY

Tap1 Time [msec] [0.0...1360.0]

Sets the Tap1 delay time.

Tap2 Time [msec] [0.0...1360.0]

Sets the Tap2 delay time.

Tap1 Level [0...100]

Sets the Tap1 output level. For more information, see “Tap1 Level” on page 838.

Feedback (Tap2) [+/-100]

Sets the Tap2 feedback amount.

High Damp [%] [0...100]

Sets the amount of high-frequency attenuation.

Wet/Dry D^{max} [Dry, 1:99...99:1, Wet]

Sets the multitap delay effect balance. For more information, see “Pan” on page 829.

Source [Off...Tempo]

Selects the Wet/Dry modulation source for the multitap delay.

Amount [+/-100]

Sets the Wet/Dry modulation amount for the multitap delay.

COMPRESSOR

For details on the Compressor graphics, see “001: Stereo Dyna Compressor” on page 763.

Sensitivity [1...100]

Sets the sensitivity. For more information, see “Sensitivity” on page 763.

Attack [1...100]

Sets the attack level. For more information, see “Attack” on page 764.

Output Level [0...100]

Sets the compressor output level. For more information, see “OUTPUT” on page 764.

LIMITER

For details on the Limiter graphics, see “005: Stereo Limiter” on page 770.

Ratio [1.0:1...50.0:1, Inf:1]

Sets the signal compression ratio. For more information, see “Ratio” on page 765.

Threshold [dB] [-40...0]

Sets the level above which the compressor is applied. For more information, see “Threshold [dB]” on page 765.

Attack [1...100]

Sets the attack time. For more information, see “Attack [msec]” on page 766.

Release [1...100]
Sets the release time. For more information, see “Release [msec]” on page 766.

Gain Adjust [dB] [-Inf, -38...+24]
Sets the limiter output gain. For more information, see “Gain Adjust [dB]” on page 766.

Pre EQ

Trim [0...100]
Sets the EQ input level.

Pre LEQ Gain [dB] [-15...+15]
Sets the gain of the Low EQ.

Pre HEQ Gain [dB] [-15...+15]
Sets the gain of the High EQ

OD/HI-GAIN

DRIVE

For more information on these parameters, see “DRIVE” on page 792.

Drive Mode [Overdrive, Hi-Gain]
Switches between overdrive and high-gain distortion.

Drive [1...100]
Sets the degree of distortion.

Output Level  [0...50]
Sets the overdrive output level.

Source [Off...Tempo]
Selects the modulation source for the overdrive output level.

Amount [-50...+50]
Sets the modulation amount of the overdrive output level.

EQ

Low Fc [Hz] [20...1.00k]
Sets the center frequency for low-frequency shelving EQ.

Gain [dB] [-18...+18]
Sets the gain of the Low EQ.

Mid1 Fc [Hz] [300...10.00k]
Sets the center frequency for Mid/High EQ 1 (peaking type).

Q [0.5...10.0]
Sets the band width of Mid/High EQ 1. For more information, see “Q” on page 776.

Gain [dB] [-18...+18]
Sets the gain of Mid/High EQ 1.

Mid2 Fc [Hz] [500...20.00k]
Sets the center frequency for Mid/High EQ 2 (peaking type).

Q [0.5...10.0]
Sets the band width of Mid/High EQ 2. For more information, see “Q” on page 776.

Gain [dB] [-18...+18]
Sets the gain of Mid/High EQ 2.

WAH

CONTROL

Sweep Mode [Auto, Dmod, LFO]
Selects the control from auto-wah, modulation source, and LFO. See “Sweep Mode” on page 780.

Source  [Off...Tempo]
Selects the modulation source for the wah when Sweep Mode=Dmod.

LFO

Frequency [Hz] [0.02...20.00]
Sets the LFO speed.

WAH

Frequency Bottom [0...100]
Sets the lower limit of the wah center frequency. p.781.

Frequency Top [0...100]
Sets the upper limit of the wah center frequency. p.781.

Resonance [0...100]
Sets the resonance amount.

LPF [Check-box]
Switches the wah low pass filter on and off.

Wet/Dry  [Dry, 1:99...99:1, Wet]
Sets the wah effect balance.

Source [Off...Tempo]
Selects the Wet/Dry modulation source for the wah.

Amount [+/-100]
Sets the Wet/Dry modulation amount for the wah.

CHORUS/FLANGER

This effect can produce either chorusing or flanging, depending on the settings.

The default settings create flanging.

To produce a chorus effect instead, change the settings as follows:

- **Frequency [Hz]:** 0.80
- **Delay Time [msec]:** 20.0
- **Depth:** 70
- **Feedback:** +0

LFO

Waveform [Triangle, Sine]
Selects the LFO Waveform.

Frequency [Hz] [0.02...20.00]
Sets the LFO speed.

FLANGER

Delay Time [msec] [0.0...1350.0]

Sets the delay time.

Depth [0...100]

Sets the depth of LFO modulation.

Feedback [+/-100]

This controls the intensity of the flanger effect. Positive and negative values create different timbres. To produce a chorus effect instead of flanging, set this to +0.

Mixing the processed and dry signals via **Wet/Dry** will enhance the effect. For maximum intensity, set **Feedback** and **Wet/Dry** so that they are either both positive or both negative; this emphasizes the flanger's harmonic peaks.

Output Mode [Normal, Wet Invert]

Normal sends the output of the chorus/flanger to both outputs with the same phase.

Wet Invert flips the phase of the chorus/flanger's right channel. This creates a pseudo-stereo effect, adding depth to the sound.

However, if a mono-input effect is connected after this effect, the left and right sounds may cancel each other, eliminating the chorus/flanger effect.

Some of the Mono-Mono Serial effects include a **Routing** parameter, which allows you to swap the order of the effects. When the **Routing** is set so that the Chorus/Flanger comes first (such as **Flanger > Comp** or **Flanger > OD/HG**), the will be grayed out; internally, it will act as if set to **Normal**.

Wet/Dry D_{mod} [-Wet...-1:99, Dry, 1: 99...Wet]

Sets the balance between the "wet" processed sound and the dry input. Negative values invert the phase of the wet signal. This interacts with **Feedback**, as described above.

Note: 138: Cho/Flanger - Multitap Dly does not include Wet/Dry modulation for the Chorus/Flanger section.

Source [Off...Tempo]

Selects the Wet/Dry modulation source for the chorus/flanger.

Amount [+/-100]

Sets the Wet/Dry modulation amount for the chorus/flanger.

PHASER

LFO

Waveform [Triangle, Sine]

Selects the LFO Waveform.

Frequency [Hz] [0.02...20.00]

Sets the LFO speed.

PHASER

Manual [0...100]

Sets the phaser's center frequency.

Depth [0...100]

Sets the depth of LFO modulation.

Resonance [+/-100]

This controls the intensity of the phaser effect. Positive and negative values create different timbres.

Mixing the processed and dry signals via **Wet/Dry** will enhance the effect. For maximum intensity, set **Resonance** and **Wet/Dry** so that they are either both positive or both negative; this emphasizes the phaser's harmonic peaks.

Output Mode [Normal, Wet Invert]

Selects whether the phaser output is mono or pseudo-stereo. For more information, see the Chorus/Flanger "Output Mode," above.

Wet/Dry D_{mod} [-Wet...-1:99, Dry, 1: 99...Wet]

Sets the balance between the "wet" processed sound and the dry input. Negative values invert the phase of the wet signal. This interacts with **Resonance**, as described above.

Note: 139: Phaser - Chorus/Flanger does not include Wet/Dry modulation for the Phaser section.

Source [Off...Tempo]

Selects the Wet/Dry modulation source for the phaser.

Amount [+/-100]

Sets the Wet/Dry modulation amount for the phaser.

109: P4EQ - Exciter

This effect combines a mono four-band parametric equalizer and an exciter.

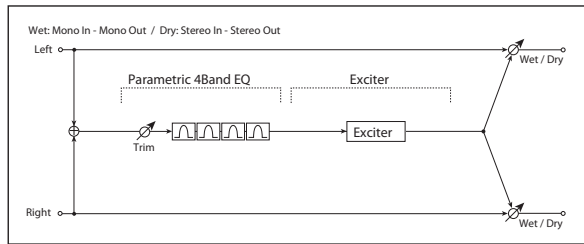

PARAMETRIC EQ

This is a 4-band parametric EQ. For detailed information, see “PARAMETRIC EQ” on page 862.

EXCITER

For detailed information on the effects parameters, see “EXCITER” on page 862.

OUTPUT

This is the standard effects output section, with modulatable control over wet/dry balance. For more information, see “OUTPUT” on page 764.

110: P4EQ - Wah

This effect combines a mono four-band parametric equalizer and a wah. You can change the order of the connection.

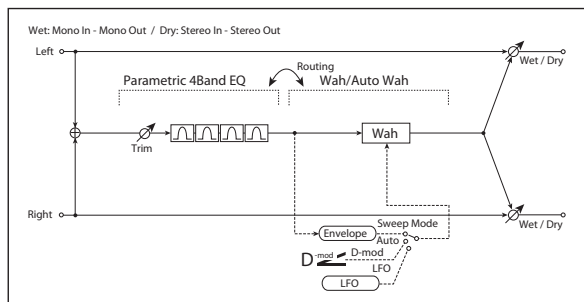

PARAMETRIC EQ

This is a 4-band parametric EQ. For detailed information, see “PARAMETRIC EQ” on page 862.

WAH

For detailed information, see “WAH” on page 863.

OUTPUT

This is the standard effects output section, with modulatable control over wet/dry balance. For more information, see “OUTPUT” on page 764.

Routing

Routing [P4EQ > Wah, Wah > P4EQ]

Changes the order of the parametric equalizer and wah connection.

111: P4EQ - Chorus/Flanger

This effect combines a mono four-band parametric equalizer and a chorus/flanger.

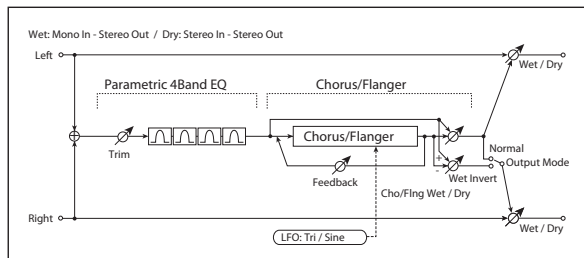

CHORUS/FLANGER

This effect can produce either chorusing or flanging, depending on the settings. For detailed information, see “CHORUS/FLANGER” on page 863.

OUTPUT

This is the standard effects output section, with modulatable control over wet/dry balance. For more information, see “OUTPUT” on page 764.

PARAMETRIC EQ

This is a 4-band parametric EQ. For detailed information, see “PARAMETRIC EQ” on page 862.

112: P4EQ - Phaser

This effect combines a mono four-band parametric equalizer and a phaser.

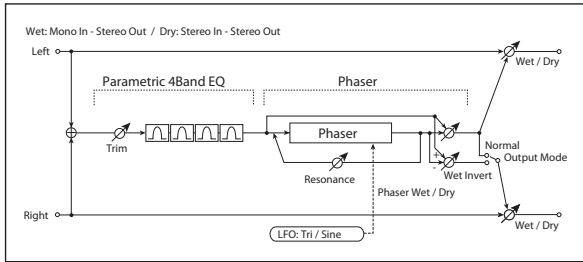

PARAMETRIC EQ

This is a 4-band parametric EQ. For detailed information, see “PARAMETRIC EQ” on page 862.

PHASER

This is a mono phaser effect. For detailed information, see “PHASER” on page 864.

OUTPUT

This is the standard effects output section, with modulatable control over wet/dry balance. For more information, see “OUTPUT” on page 764.

113: P4EQ - Multitap Delay

This effect combines a mono four-band parametric equalizer and a multitap delay.

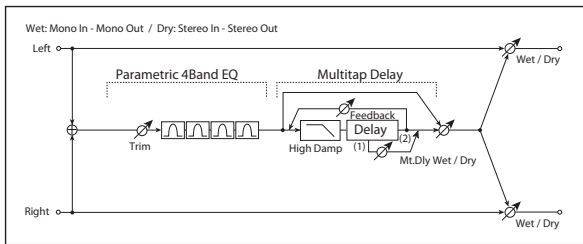

PARAMETRIC EQ

This is a 4-band parametric EQ. For detailed information, see “PARAMETRIC EQ” on page 862.

MULTITAP DELAY

This is a 2-tap delay. For detailed information, see “MULTITAP DELAY” on page 862.

OUTPUT

This is the standard effects output section, with modulatable control over wet/dry balance. For more information, see “OUTPUT” on page 764.

114: Comp - Wah

This effect combines a mono compressor and a wah. You can change the order of the connection.

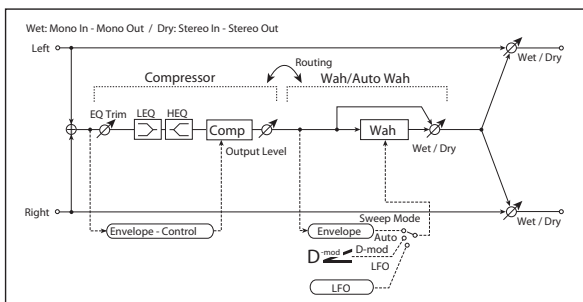

Routing

Routing [Comp > Wah, Wah > Comp]

Switches the order of the compressor and wah.

COMPRESSOR

Pre EQ

For detailed information, see “Pre EQ” on page 863.

COMPRESSOR

For detailed information, see “COMPRESSOR” on page 862.

WAH

For detailed information, see “WAH” on page 863.

OUTPUT

This is the standard effects output section, with modulatable control over wet/dry balance. For more information, see “OUTPUT” on page 764.

115: Comp - Amp Sim

This effect combines a mono compressor and an amp simulation. You can change the order of the effects.

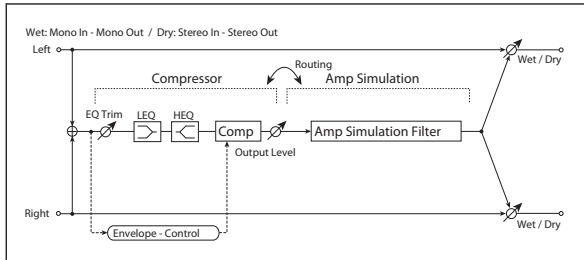

Routing

Routing [Comp > Amp, Amp > Comp]

Switches the order of the compressor and amp simulation.

COMPRESSOR

Pre EQ

For detailed information, see “Pre EQ” on page 863.

COMPRESSOR

For detailed information, see “COMPRESSOR” on page 862.

AMP SIM

Amplifier Type [SS, EL84, 6L6]

Selects the type of guitar amplifier.

OUTPUT

This is the standard effects output section, with modulatable control over wet/dry balance. For more information, see “OUTPUT” on page 764.

116: Comp - OD/HiGain

This effect combines a mono compressor and an overdrive/high-gain distortion. You can change the order of the effects.

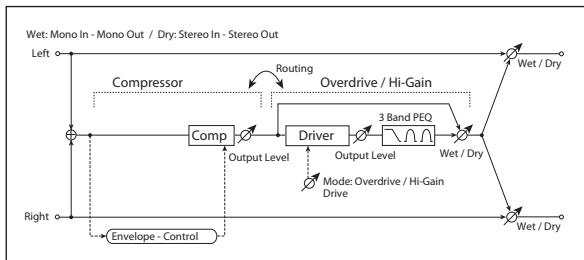

Routing

Routing [Comp > OD/HG, OD/HG > Comp]

Switches the order of the compressor and overdrive.

COMPRESSOR

For detailed information, see “COMPRESSOR” on page 862.

OD/HI-GAIN

For detailed information, see “OD/HI-GAIN” on page 863.

OUTPUT

This is the standard effects output section, with modulatable control over wet/dry balance. For more information, see “OUTPUT” on page 764.

117: Comp - P4EQ

This effect combines a mono compressor and a four-band parametric equalizer. You can change the order of the effects.

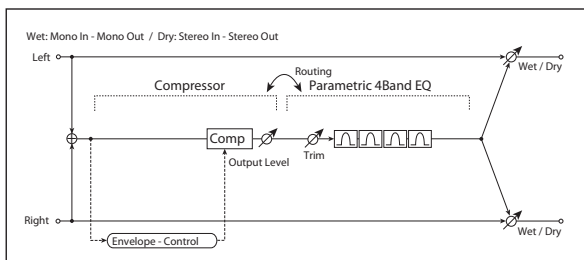

Routing

Routing [Comp > P4EQ, P4EQ > Comp]

Switches the order of the compressor and parametric EQ.

COMPRESSOR

For detailed information, see “COMPRESSOR” on page 862.

PARAMETRIC EQ

This is a 4-band parametric EQ. For detailed information, see “PARAMETRIC EQ” on page 862.

OUTPUT

This is the standard effects output section, with modulatable control over wet/dry balance. For more information, see “OUTPUT” on page 764.

118: Comp - Chorus/Flanger

This effect combines a mono compressor and a chorus/flanger. You can change the order of the effects.

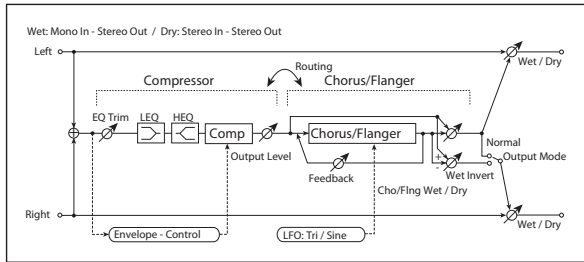

Routing

Routing [Comp > Flanger, Flanger > Comp]

Switches the order of the compressor and chorus/flanger.

When **Routing** is set to **Flanger > Comp**, the Chorus/Flanger’s **Output Mode** will be grayed out and internally set to **Normal**.

COMPRESSOR

Pre EQ

For detailed information, see “Pre EQ” on page 863.

COMPRESSOR

For detailed information, see “COMPRESSOR” on page 862.

CHORUS/FLANGER

This effect can produce either chorusing or flanging, depending on the settings. For detailed information, see “CHORUS/FLANGER” on page 863.

OUTPUT

This is the standard effects output section, with modulatable control over wet/dry balance. For more information, see “OUTPUT” on page 764.

119: Comp - Phaser

This effect combines a mono compressor and a phaser. You can change the order of the effects.

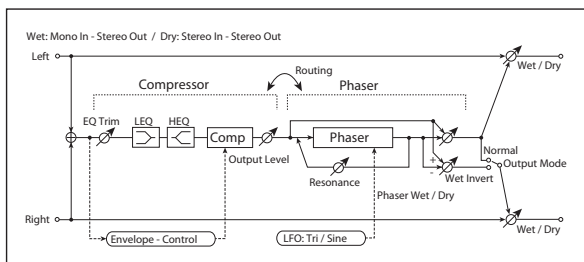

Routing

Routing [Comp > Phaser, Phaser > Comp]

Switches the order of the compressor and phaser.

When **Routing** is set to **Phaser > Comp**, the Phaser’s **Output Mode** will be grayed out and internally set to **Normal**.

COMPRESSOR

For detailed information, see “COMPRESSOR” on page 862.

PHASER

Pre EQ

For detailed information, see “Pre EQ” on page 863.

LFO and PHASER

This is a mono phaser effect. For detailed information, see “PHASER” on page 864.

OUTPUT

This is the standard effects output section, with modulatable control over wet/dry balance. For more information, see “OUTPUT” on page 764.

120: Comp - Multitap Delay

This effect combines a mono compressor and a multitap delay. You can change the order of the effects.

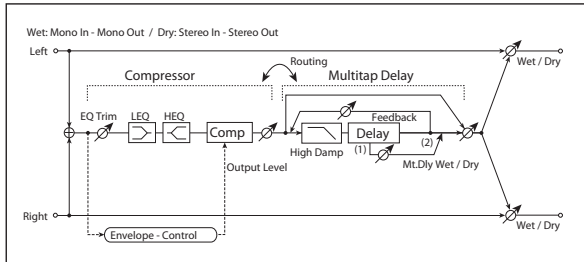

Routing

Routing [Comp > Mt.Delay, Mt.Delay > Comp]

Switches the order of the compressor and multitap delay.

Pre EQ

For detailed information, see “Pre EQ” on page 863.

COMPRESSOR

For detailed information, see “COMPRESSOR” on page 862.

MULTITAP DELAY

This is a 2-tap delay. For detailed information, see “MULTITAP DELAY” on page 862.

OUTPUT

This is the standard effects output section, with modulatable control over wet/dry balance. For more information, see “OUTPUT” on page 764.

121: Limiter - P4EQ

This effect combines a mono limiter and a four-band parametric equalizer. You can change the order of the effects.

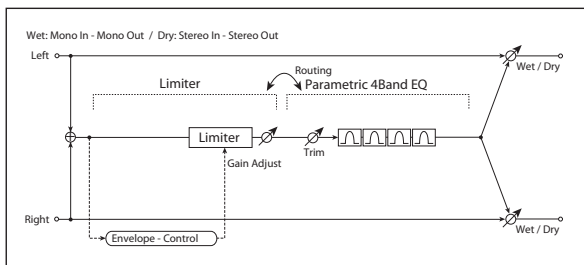

Routing

Routing [Limiter > P4EQ, P4EQ > Limiter]

Switches the order of the limiter and parametric EQ.

LIMITER

For detailed information, see “LIMITER” on page 862.

PARAMETRIC EQ

This is a 4-band parametric EQ. For detailed information, see “PARAMETRIC EQ” on page 862.

OUTPUT

This is the standard effects output section, with modulatable control over wet/dry balance. For more information, see “OUTPUT” on page 764.

122: Limiter - Chorus/Flanger

This effect combines a mono limiter and a chorus/flanger. You can change the order of the effects.

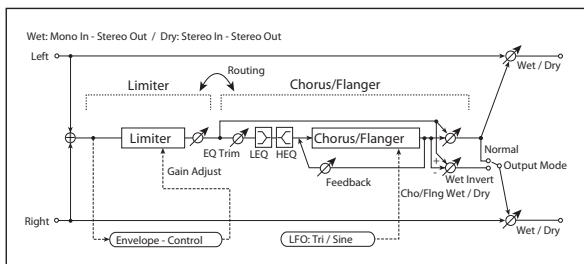

Routing

Routing [Limiter > Flanger, Flanger > Limiter]

Switches the order of the limiter and chorus/flanger.

When **Routing** is set to **Flanger > Limiter**, the Chorus/Flanger’s **Output Mode** will be grayed out and internally set to **Normal**.

LIMITER

For detailed information, see “LIMITER” on page 862.

CHORUS/FLANGER

Pre EQ

For detailed information, see “Pre EQ” on page 863.

LFO and FLANGER

This effect can produce either chorusing or flanging, depending on the settings. For detailed information, see “CHORUS/FLANGER” on page 863.

OUTPUT

This is the standard effects output section, with modulatable control over wet/dry balance. For more information, see “OUTPUT” on page 764.

123: Limiter - Phaser

This effect combines a mono limiter and a phaser. You can change the order of the effects.

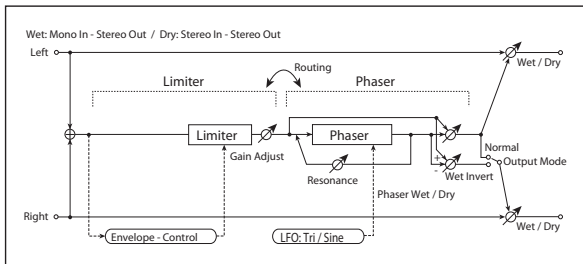

When **Routing** is set to **Phaser > Limiter**, the Phaser’s **Output Mode** will be grayed out and internally set to **Normal**.

LIMITER

For detailed information, see “LIMITER” on page 862.

PHASER

This is a mono phaser effect. For detailed information, see “PHASER” on page 864.

Routing

Routing [Limiter > Phaser, Phaser > Limiter]

Switches the order of the limiter and phaser.

OUTPUT

This is the standard effects output section, with modulatable control over wet/dry balance. For more information, see “OUTPUT” on page 764.

124: Limiter - Multitap Delay

This effect combines a mono limiter and a multitap delay. You can change the order of the effect s.

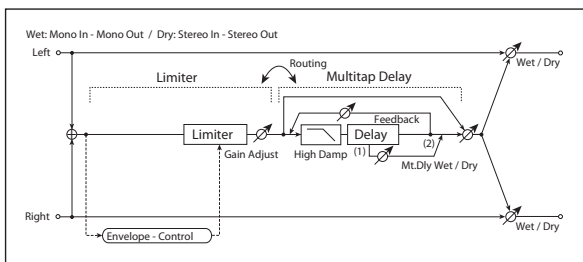

OUTPUT

This is the standard effects output section, with modulatable control over wet/dry balance. For more information, see “OUTPUT” on page 764.

Routing

Routing [Limiter > Mt.Delay, Mt.Delay > Limiter]

Switches the order of the limiter and multitap delay.

LIMITER

For detailed information, see “LIMITER” on page 862.

MULTITAP DELAY

This is a 2-tap delay. For detailed information, see “MULTITAP DELAY” on page 862.

125: Exciter - Comp

This effect combines a mono exciter and a compressor. You can change the order of the effects.

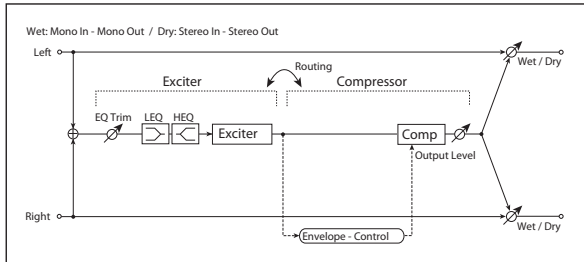

Routing

Routing [Exciter > Comp, Comp > Exciter]

Switches the order of the exciter and compressor.

EXCITER

Pre EQ

For detailed information, see “Pre EQ” on page 863.

EXCITER

For detailed information, see “EXCITER” on page 862.

COMPRESSOR

For detailed information, see “COMPRESSOR” on page 862.

OUTPUT

This is the standard effects output section, with modulatable control over wet/dry balance. For more information, see “OUTPUT” on page 764.

126: Exciter - Limiter

This effect combines a mono exciter and a limiter. You can change the order of the effects.

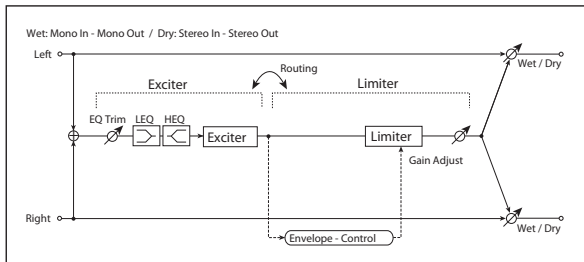

Routing

Routing [Exciter > Limiter, Limiter > Exciter]

Switches the order of the exciter and limiter.

EXCITER

Pre EQ

For detailed information, see “Pre EQ” on page 863.

EXCITER

For detailed information, see “EXCITER” on page 862.

LIMITER

For detailed information, see “LIMITER” on page 862.

OUTPUT

This is the standard effects output section, with modulatable control over wet/dry balance. For more information, see “OUTPUT” on page 764.

127: Exciter - Chorus/Flanger

This effect combines a mono limiter and a chorus/flanger.

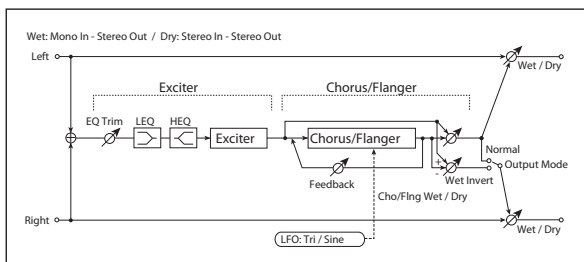

EXCITER

Pre EQ

For detailed information, see “Pre EQ” on page 863.

EXCITER

For detailed information, see “EXCITER” on page 862.

CHORUS/FLANGER

This effect can produce either chorusing or flanging, depending on the settings. For detailed information, see “CHORUS/FLANGER” on page 863.

OUTPUT

This is the standard effects output section, with modulatable control over wet/dry balance. For more information, see “OUTPUT” on page 764.

128: Exciter - Phaser

This effect combines a mono limiter and a phaser.

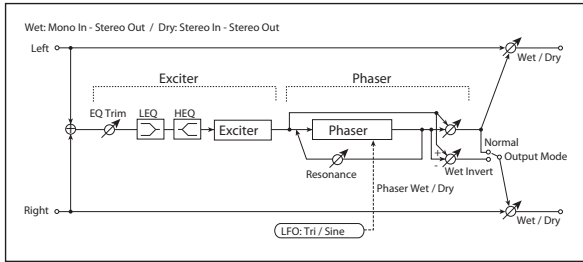

EXCITER

Pre EQ

For detailed information, see “Pre EQ” on page 863.

EXCITER

For detailed information, see “EXCITER” on page 862.

PHASER

This is a mono phaser effect. For detailed information, see “PHASER” on page 864.

OUTPUT

This is the standard effects output section, with modulatable control over wet/dry balance. For more information, see “OUTPUT” on page 764.

129: Exciter - Multitap Delay

This effect combines a mono exciter and a multitap delay.

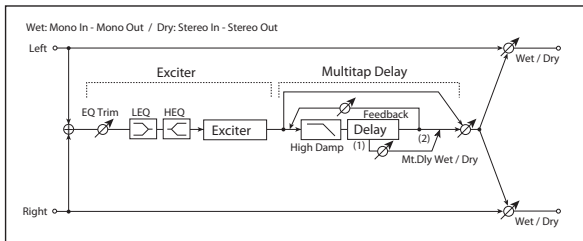

EXCITER

Pre EQ

For detailed information, see “Pre EQ” on page 863.

EXCITER

For detailed information, see “EXCITER” on page 862.

MULTITAP DELAY

This is a 2-tap delay. For detailed information, see “MULTITAP DELAY” on page 862.

OUTPUT

This is the standard effects output section, with modulatable control over wet/dry balance. For more information, see “OUTPUT” on page 764.

130: OD/Hi Gain - Amp Sim

This effect combines a mono overdrive/high-gain distortion and an amp simulation. You can change the order of the effects.

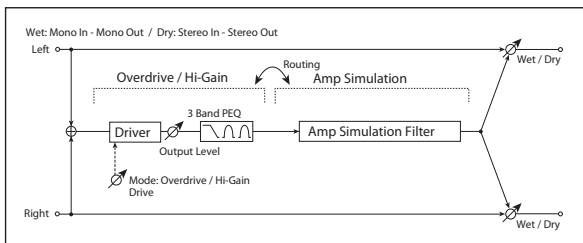

Routing

Routing [OD/HG > Amp, Amp > OD/HG]

Switches the order of the overdrive and amp.

OD/HI-GAIN

For detailed information, see “OD/HI-GAIN” on page 863.

AMP SIM

Amplifier Type

[SS, EL84, 6L6]

Selects the type of guitar amplifier.

OUTPUT

This is the standard effects output section, with modulatable control over wet/dry balance. For more information, see “OUTPUT” on page 764.

131: OD/Hi Gain - Cho/Flanger

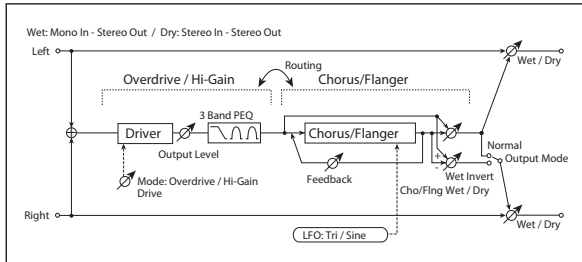

This effect combines a mono overdrive/high-gain distortion and a chorus/flanger. You can change the order of the effects.

Routing

Routing [OD/HG > Flanger, Flanger > OD/HG]

Switches the order of the overdrive and chorus / flanger.

When **Routing** is set to **Flanger > OD/HG**, the Chorus/Flanger's **Output Mode** will be grayed out and internally set to **Normal**.

OD/HI-GAIN

For detailed information, see "OD/HI-GAIN" on page 863.

CHORUS/FLANGER

This effect can produce either chorusing or flanging, depending on the settings. For detailed information, see "CHORUS/FLANGER" on page 863.

OUTPUT

This is the standard effects output section, with modulatable control over wet/dry balance. For more information, see "OUTPUT" on page 764.

132: OD/Hi Gain - Phaser

This effect combines a mono overdrive/high-gain distortion and a phaser. You can change the order of the effects.

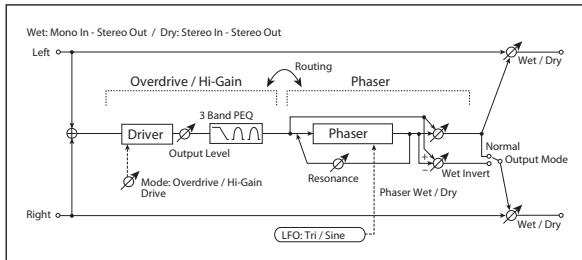

Routing

Routing [OD/HG > Phaser, Phaser > OD/HG]

Switches the order of the overdrive and phaser.

When **Routing** is set to **Phaser > OD/HG**, the Phaser's will be grayed out and internally set to **Normal**.

OD/HI-GAIN

For detailed information, see "OD/HI-GAIN" on page 863.

PHASER

This is a mono phaser effect. For detailed information, see "PHASER" on page 864.

OUTPUT

This is the standard effects output section, with modulatable control over wet/dry balance. For more information, see "OUTPUT" on page 764.

133: OD/Hi Gain - Multitap Dly

This effect combines a mono overdrive/high-gain distortion and a multitap delay

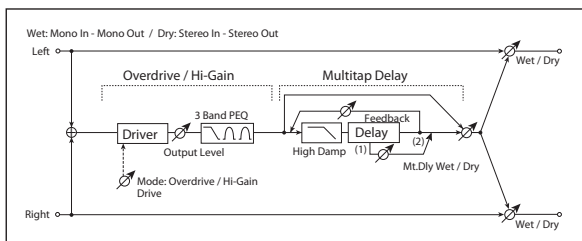

OD/HI-GAIN

For detailed information, see "OD/HI-GAIN" on page 863.

MULTITAP DELAY

For detailed information, see "MULTITAP DELAY" on page 862.

OUTPUT

This is the standard effects output section, with modulatable control over wet/dry balance. For more information, see "OUTPUT" on page 764.

134: Wah - Amp Sim

This effect combines a mono wah and an amp simulation. You can change the order of the effects.

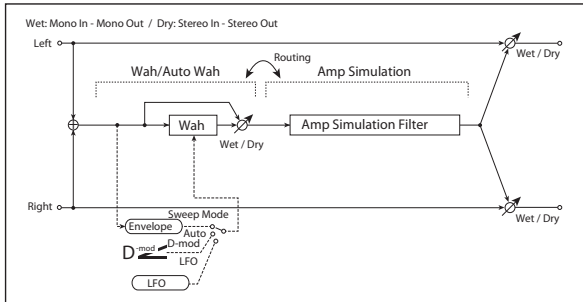

Routing

Routing [Wah > Amp, Amp > Wah]

Switches the order of the wah and amp simulation.

135: Decimator - Amp Sim

This effect combines a mono decimator and an amp simulation. You can change the order of the effects.

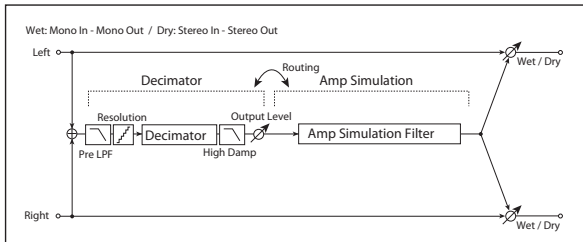

Routing

Routing [Decimator > Amp, Amp > Decimator]

Switches the order of the decimator and amp simulation.

DECIMATOR

Pre LPF [Check-box]

Turn the harmonic noise caused by lowered sampling on and off. See “Pre LPF” on page 787.

Sampling Frequency [Hz] [1.00k...48.00k]

Sets the sampling frequency.

High Damp [%] [0...100]

Sets the amount of high-frequency attenuation.

BIT SHAPE

For more information on these parameters, see “Resolution [bits]” on page 787.

Resolution [bits] [4...24]

Sets the data bit length.

Output Level [0...100]

Sets the decimator output level.

WAH

For detailed information, see “WAH” on page 863.

AMP SIM

Amplifier Type [SS, EL84, 6L6]

Selects the type of guitar amplifier.

OUTPUT

This is the standard effects output section, with modulatable control over wet/dry balance. For more information, see “OUTPUT” on page 764.

AMP SIM

Amplifier Type [SS, EL84, 6L6]

Selects the type of guitar amplifier.

OUTPUT

This is the standard effects output section, with modulatable control over wet/dry balance. For more information, see “OUTPUT” on page 764.

136: Decimator - Comp

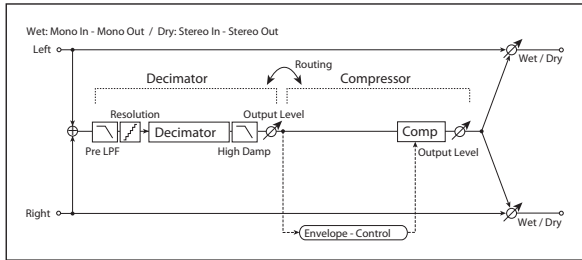

This effect combines a mono decimator and a compressor. You can change the order of the effects.

Routing

Routing [Decimator > Comp, Comp > Decimator]

Switches the order of the decimator and compressor.

DECIMATOR

Pre LPF [Check-box]

Enables and disables a filter which prevents aliasing noise. See “Pre LPF” on page 787.

Sampling Frequency [Hz] [1.00k...48.00k]

Sets the sampling frequency.

High Damp [%] [0...100]

Sets the amount of high-frequency attenuation.

BIT SHAPE

For more information on these parameters, see “Resolution [bits]” on page 787.

Resolution [bits] [4...24]

Sets the data bit length.

Output Level [0...100]

Sets the decimator output level.

COMPRESSOR

For detailed information, see “COMPRESSOR” on page 862.

OUTPUT

This is the standard effects output section, with modulatable control over wet/dry balance. For more information, see “OUTPUT” on page 764.

137: Amp Sim - Tremolo

This effect combines a mono amp simulation and a tremolo.

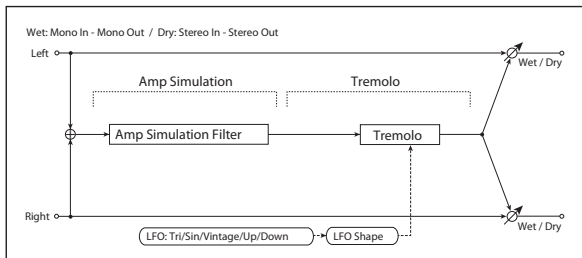

AMP SIM

Amplifier Type [SS, EL84, 6L6]

Selects the type of guitar amplifier.

TREMOLO

LFO

Waveform [Triangle, Sine, Vintage, Up, Down]

Selects the LFO Waveform. See “Waveform” on page 819.

Shape [+/-100]

Changes the curvature of the LFO Waveform. See “Shape” on page 784.

Frequency [Hz] [0.02...20.00]

Sets the LFO speed.

TREMOLO

Depth [0...100]

Sets the depth of LFO modulation.

OUTPUT

This is the standard effects output section, with modulatable control over wet/dry balance. For more information, see “OUTPUT” on page 764.

138: Cho/Flanger - Multitap Dly

This effect combines a mono chorus/flanger and a multitap delay.

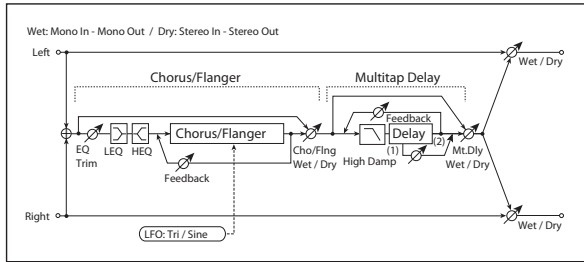

CHORUS/FLANGER

Pre EQ

For detailed information, see “Pre EQ” on page 863.

139: Phaser - Chorus/Flanger

This effect combines a mono phaser and a chorus/flanger.

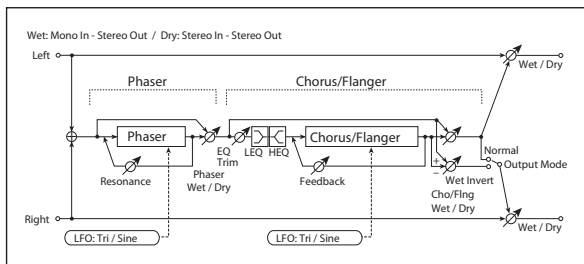

PHASER

This is a mono phaser effect. For detailed information, see “PHASER” on page 864.

140: Reverb - Gate

This effect combines a mono reverb and a gate.

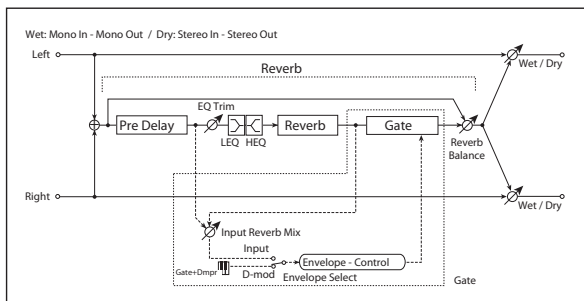

REVERB

Pre EQ

Trim [0...100]
Sets the EQ input level.

LFO and FLANGER

This effect can produce either chorusing or flanging, depending on the settings. For detailed information, see “CHORUS/FLANGER” on page 863.

Note: Unlike the other Mono-Mono Serial effects, this Chorus/Flanger does not include modulation of Wet/Dry.

MULTITAP DELAY

For detailed information, see “MULTITAP DELAY” on page 862.

OUTPUT

This is the standard effects output section, with modulatable control over wet/dry balance. For more information, see “OUTPUT” on page 764.

CHORUS/FLANGER

Pre EQ

For detailed information, see “Pre EQ” on page 863.

LFO and FLANGER

This effect can produce either chorusing or flanging, depending on the settings. For detailed information, see “CHORUS/FLANGER” on page 863.

OUTPUT

This is the standard effects output section, with modulatable control over wet/dry balance. For more information, see “OUTPUT” on page 764.

LEQ Fc [Low, Mid-Low]

Selects the cutoff frequency (low or mid-low) of the low-range equalizer.

LEQ Gain [dB] [-15.0...+15.0]

Sets the gain of the Low EQ.

HEQ Fc [High, Mid-High]

Selects the cutoff frequency (high or mid-high) of the high-range equalizer.

HEQ Gain [dB] [-15.0...+15.0]

Sets the gain of the High EQ.

REVERB

Pre Delay [msec] [0...200]

Sets the delay time of the reverb sound and gate control signal.

High Damp [%] [0...100]

Sets the amount of high-frequency attenuation.

Reverb Time [sec] [0.1...10.0]

Sets the reverberation time.

Wet/Dry [Dry, 1:99...99:1, Wet]

Sets the reverb effect balance.

GATE

For details on the Gate graphics, see “009: Stereo Gate” on page 774.

CONTROL**Envelope Select [Dmod, Input]**

This chooses whether the gate is triggered by the signal level, or controlled directly by the selected Dmod **Source**.

When **Envelope Select** is set to **Input**, the gate is controlled by a blend of the dry audio input and the reverb output, as set by the **Input Reverb Mix**.

Source  [Off...Tempo]

Selects the modulation source that controls the gate when **Envelope Select** is set to **Dmod**.

Input Reverb Mix [Dry, 1:99...99:1, Wet]

This mixes the dry input and reverb output signals, for controlling the gate.

Normally, set **Input Reverb Mix** to **Dry**, so that the gate is controlled only by the dry input. If you wish to extend the gate time, increase the **Input Reverb Mix** value to include some of the wet mix as well, and adjust the **Threshold**.

GATE**Threshold [0...100]**

Sets the gate threshold level. When the signal level exceeds the threshold, the gate opens and the reverb sound is heard.

Note that this applies only when **Envelope Select** is set to **Input**. When the gate is controlled via Dmod, it opens when the Dmod value is 64 or higher, and closes when the value is 63 or lower.

Attack [1...100]

Sets the attack time. See “Attack” on page 774.

Release [1...100]

Sets the release time. See “Release” on page 774.

Polarity [+,-]

This lets you invert the gate on/off state. See “Polarity” on page 774.

OUTPUT

This is the standard effects output section, with modulatable control over wet/dry balance. For more information, see “OUTPUT” on page 764.

Mono/Mono Parallel

141: P4EQ // P4EQ through 185: Mt.BPM Dly//Mt.BPM Dly are parallel effects, with the left input going through one effect, and the right going through the other. These provide various combinations of 4-band EQ, Compressor, Limiter, Exciter, Overdrive, Wah, Chorus/Flanger, Phaser, and Multitap Delay, as described below.

4 band EQ

For a description of the on-screen EQ graphic, see “011: Stereo Parametric 4EQ” on page 776.

PARAMETRIC EQ

Trim [0...100]

Sets the input level.

Band1 Fc [Hz] [20...1.00k]

Sets the center frequency of Band 1.

Q [0.5...10.0]

Sets the bandwidth of Band 1. See “Q” on page 776.

Gain [dB] [-18.0...+18.0]

Sets the gain of Band 1.

Band2 Fc [Hz] [50...5.00k]

Sets the center frequency of Band 2.

Q [0.5...10.0]

Sets the bandwidth of Band 2. See “Q” on page 776.

Gain [dB] [-18.0...+18.0]

Sets the gain of Band 2.

Band3 Fc [Hz] [300...10.00k]

Sets the center frequency of Band 3.

Q [0.5...10.0]

Sets the bandwidth of Band3. See “Q” on page 776.

Gain [dB] [-18.0...+18.0]

Sets the gain of Band 3.

Band4 Fc [Hz] [500...20.00k]

Sets the center frequency of Band 4.

Q [0.5...10.0]

Sets the bandwidth of Band 4. See “Q” on page 776.

Gain [dB] [-18.0...+18.0]

Sets the gain of Band 4.

OUTPUT

Pan [L000...C064...R127]

Sets the stereo image.

Wet/Dry  [Dry, 1:99...99:1, Wet]

Sets the balance between the effect and the dry input.

Source [Off...Tempo]

Selects a modulation source for Wet/Dry.

Amount [+/-100]

Sets the modulation amount for Wet/Dry.

Compressor

For details on the Compressor graphics, see “001: Stereo Dyna Compressor” on page 763.

Pre EQ

Trim [0...100]

Sets the EQ input level.

LEQ Gain [dB] [-15...+15]

Sets the gain of the Low EQ.

HEQ Gain [dB] [-15...+15]

Sets the gain of the High EQ.

COMPRESSOR

Sensitivity [1...100]

Sets the sensitivity. See “Sensitivity” on page 763.

Attack [1...100]

Sets the attack level. See “Attack” on page 764.

Output Level [0...100]

Sets the output level.

OUTPUT

Pan [L000...C064...R127]

Sets the stereo image.

Wet/Dry  [Dry, 1:99...99:1, Wet]

Sets the balance between the effect and the dry input.

Source [Off...Tempo]

Selects a modulation source for Wet/Dry.

Amount [+/-100]

Sets the modulation amount for Wet/Dry.

Limiter

For details on the Limiter graphics, see “005: Stereo Limiter” on page 770.

LIMITER

Ratio [1.0:1...50.0:1, Inf:1]

Sets the signal compression ratio. See “Ratio” on page 765.

Threshold [dB] [-40...0]

Sets the level above which the compressor is applied. See “Threshold [dB]” on page 765.

Attack [1...100]

Sets the attack time. See “Attack [msec]” on page 766.

Release [1...100]

Sets the release time. See “Release [msec]” on page 766.

Gain Adjust [dB] [-Inf, -38...+24]

Sets the output gain. See “Gain Adjust [dB]” on page 766.

OUTPUT

Pan [L000...C064...R127]

Sets the stereo image.

Wet/Dry D_{mod} [Dry, 1:99...99:1, Wet]

Sets the balance between the effect and the dry input.

Source [Off...Tempo]

Selects a modulation source for Wet/Dry.

Amount [+/-100]

Sets the modulation amount for Wet/Dry.

Exciter

Pre EQ

Trim [0...100]

Sets the EQ input level.

LEQ Gain [dB] [-15...+15]

Sets the gain of the Low EQ.

HEQ Gain [dB] [-15...+15]

Sets the gain of the High EQ.

EXCITER

Emphasis Frequency [0...70]

Sets the frequency range to be emphasized. See “Emphasis Frequency” on page 779.

Exciter Blend [+/-100]

Sets the intensity (depth) of the Exciter effect. See “Blend” on page 779.

OUTPUT

Pan [L000...C064...R127]

Sets the stereo image.

Wet/Dry D_{mod} [Dry, 1:99...99:1, Wet]

Sets the balance between the effect and the dry input.

Source [Off...Tempo]

Selects a modulation source for Wet/Dry.

Amount [+/-100]

Sets the modulation amount for Wet/Dry.

OD/HI-GAIN

DRIVE

For more information on these parameters, see “DRIVE” on page 792.

Drive Mode [Overdrive, Hi-Gain]

Switches between overdrive and high-gain distortion.

Drive [1...100]

Sets the degree of distortion.

Output Level D_{mod} [0...50]

Sets the output level.

Source [Off...Tempo]

Selects the modulation source for the output level.

Amount [-50...+50]

Sets the modulation amount of the output level.

EQ

Low Fc [Hz] [20...1.00k]

Sets the center frequency for Low EQ (shelving type).

Gain [dB] [-18...+18]

Sets the gain of the Low EQ.

Mid1 Fc [Hz] [300...10.00k]

Sets the center frequency for Mid/High EQ 1 (peaking type).

Q [0.5...10.0]

Sets the band width of Mid/High EQ 1. See “Q” on page 776.

Gain [dB] [-18...+18]

Sets the gain of Mid/High EQ 1.

Mid2 Fc [Hz] [500...20.00k]

Sets the center frequency for Mid/High EQ 2 (peaking type).

Q [0.5...10.0]

Sets the band width of Mid/High EQ 2. See “Q” on page 776.

Gain [dB] [-18...+18]

Sets the gain of Mid/High EQ 2.

OUTPUT

Pan [L000...C064...R127]

Sets the stereo image.

Wet/Dry D_{mod} [Dry, 1:99...99:1, Wet]

Sets the balance between the effect and the dry input.

Source [Off...Tempo]

Selects a modulation source for Wet/Dry.

Amount [+/-100]

Sets the modulation amount for Wet/Dry.

WAH

CONTROL

Sweep Mode [Auto, Dmod, LFO]

Selects the control from auto-wah, modulation source, and LFO. See “Sweep Mode” on page 780.

Source D_{mod} [Off...Tempo]

Selects the modulation source for the wah when Sweep Mode=Dmod.

LFO

LFO Frequency [Hz] [0.02...20.00]

Sets the LFO speed.

WAH

Frequency Bottom [0...100]

Sets the lower limit of the wah center frequency. See “Frequency Bottom” on page 781.

Frequency Top [0...100]

Sets the upper limit of the wah center frequency. See “Frequency Bottom” on page 781.

Resonance [+0...+100]

Sets the resonance amount.

Low Pass Filter [Check-box]

Switches the wah low pass filter on and off.

OUTPUT

Pan [L000...C064...R127]

Sets the stereo image.

Wet/Dry  [Dry, 1:99...99:1, Wet]

Sets the balance between the effect and the dry input.

Source [Off...Tempo]

Selects a modulation source for Wet/Dry.

Amount [+/-100]

Sets the modulation amount for Wet/Dry.

Chorus/Flanger

Pre EQ

Trim [0...100]

Sets the EQ input level.

LEQ Gain [dB] [-15...+15]

Sets the gain of the Low EQ.

HEQ Gain [dB] [-15...+15]

Sets the gain of the High EQ.

LFO

Waveform [Triangle, Sine]

Selects the LFO Waveform.

Frequency [Hz] [0.02...20.00]

Sets the LFO speed.

FLANGER

Delay Time [msec] [0.0...1350.0]

Sets the delay time.

Depth [0...100]

Sets the depth of LFO modulation.

Feedback [+/-100]

Sets the feedback amount. See “Feedback” on page 808.

OUTPUT

Pan [L000...C064...R127]

Sets the stereo image.

Wet/Dry  [Dry, 1:99...99:1, Wet]

Sets the balance between the effect and the dry input.

Source [Off...Tempo]

Selects a modulation source for Wet/Dry.

Amount [+/-100]

Sets the modulation amount for Wet/Dry.

Phaser

LFO

Waveform [Triangle, Sine]

Selects the LFO Waveform.

Frequency [Hz] [0.02...20.00]

Sets the LFO speed.

PHASER

Manual [0...100]

Sets the frequency to which the effect is applied.

Depth [0...100]

Sets the depth of LFO modulation.

Resonance [+/-100]

Sets the resonance amount. See “Resonance” on page 810.

OUTPUT

Pan [L000...C064...R127]

Sets the stereo image.

Wet/Dry  [Dry, 1:99...99:1, Wet]

Sets the balance between the effect and the dry input.

Source [Off...Tempo]

Selects a modulation source for Wet/Dry.

Amount [+/-100]

Sets the modulation amount for Wet/Dry.

Multi-tap BPM Delay

MT DELAY

BPM  [MIDI, 40.00...300.00]

MIDI syncs to the system tempo; 40-240 sets the tempo manually for this individual effect. See “BPM” on page 827.

Time Over? > [---, OVER!]

Displays an error message when the delay time exceeds the upper limit. See “Time Over? R >” on page 849.

Tap1 Base Note  [♪...♩]

Selects the type of notes to specify the delay time for Tap1. See “Base Note” on page 827.

Times [x1...x32]

Sets the number of notes to specify the delay time for Tap1. See “Times” on page 827.

Tap2 Base Note [♩... ♩]

Selects the type of notes to specify the delay time for Tap2. See “Base Note” on page 827.

Times [x1...x32]

Sets the number of notes to specify the delay time for Tap2. See “Times” on page 827.

Tap1 Level [0...100]

Sets the Tap1 output level.

Feedback [+/-100]

Sets the Tap2 feedback amount.

High Damp [%] [0...100]

Sets the amount of high-frequency attenuation. See “High Damp [%]” on page 835.

OUTPUT

Pan [L000...C064...R127]

Sets the stereo image.

Wet/Dry [Dry, 1:99...99:1, Wet]

Sets the balance between the effect and the dry input.

Source [Off...Tempo]

Selects a modulation source for Wet/Dry.

Amount [+/-100]

Sets the modulation amount for Wet/Dry.

141: P4EQ // P4EQ

This effect connects two four-band EQ units in parallel. The pan and effect balance can be adjusted independently for each.

For detailed information on the effects parameters, see “4 band EQ” on page 878.

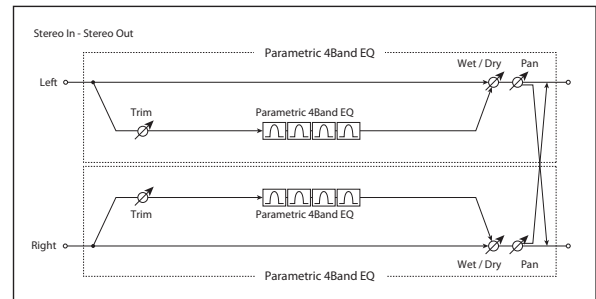

142: P4EQ // Comp

This effect connects a four-band EQ and a compressor in parallel. The pan and effect balance can be adjusted independently for each.

For detailed information on the effects parameters, see “4 band EQ” on page 878 and “Compressor” on page 878.

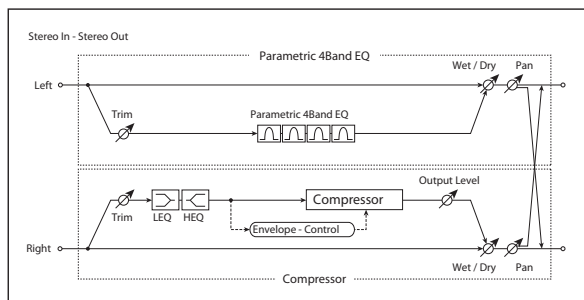

143: P4EQ // Limiter

This effect connects a four-band EQ (p.878) and a limiter (p.878) in parallel. The pan and effect balance can be adjusted independently for each.

For detailed information on the effects parameters, see “4 band EQ” on page 878 and “Limiter” on page 878.

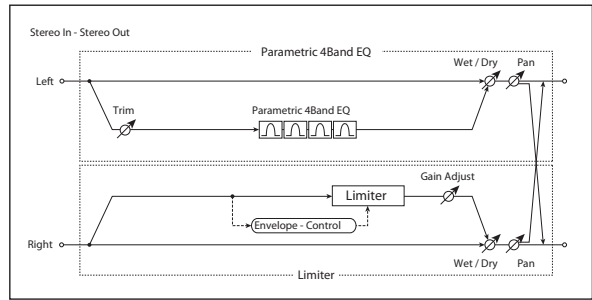

144: P4EQ // Exciter

This effect connects a four-band EQ and an exciter in parallel. The pan and effect balance can be adjusted independently for each.

For detailed information on the effects parameters, see “4 band EQ” on page 878 and “Exciter” on page 879.

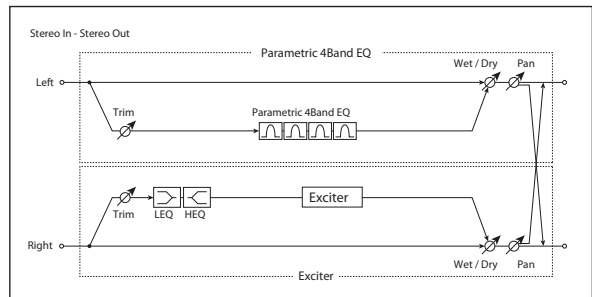

145: P4EQ // OD/Hi Gain

This effect connects a four-band EQ and an overdrive in parallel. The pan and effect balance can be adjusted independently for each.

For detailed information on the effects parameters, see “4 band EQ” on page 878 and “OD/HI-GAIN” on page 879.

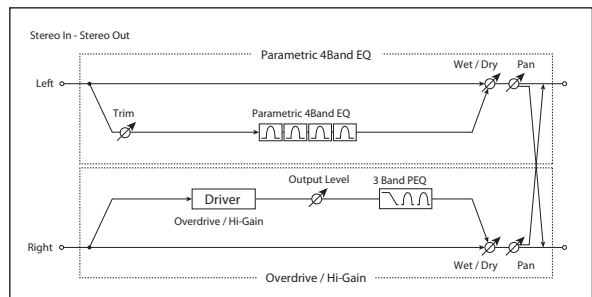

146: P4EQ // Wah

This effect connects a four-band EQ and a wah in parallel. The pan and effect balance can be adjusted independently for each.

For detailed information on the effects parameters, see “4 band EQ” on page 878 and “WAH” on page 879.

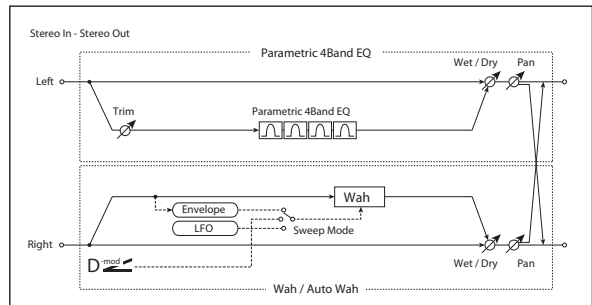

147: P4EQ // Chorus/Flanger

This effect connects a four-band EQ and a chorus / flanger in parallel. The pan and effect balance can be adjusted independently for each.

For detailed information on the effects parameters, see “4 band EQ” on page 878 and “Chorus/Flanger” on page 880.

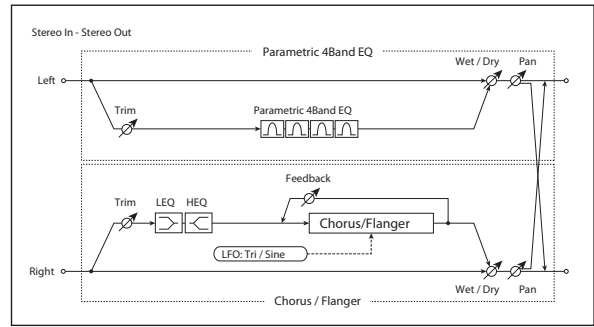

148: P4EQ // Phaser

This effect connects a four-band EQ and a phaser in parallel. The pan and effect balance can be adjusted independently for each.

For detailed information on the effects parameters, see “4 band EQ” on page 878 and “Phaser” on page 880.

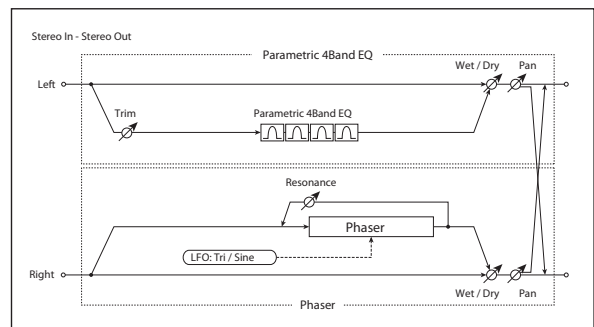

149: P4EQ // Multitap BPM Dly

This effect connects a four-band EQ and a multitap BPM delay in parallel. The pan and effect balance can be adjusted independently for each.

For detailed information on the effects parameters, see “4 band EQ” on page 878 and “Multi-tap BPM Delay” on page 880.

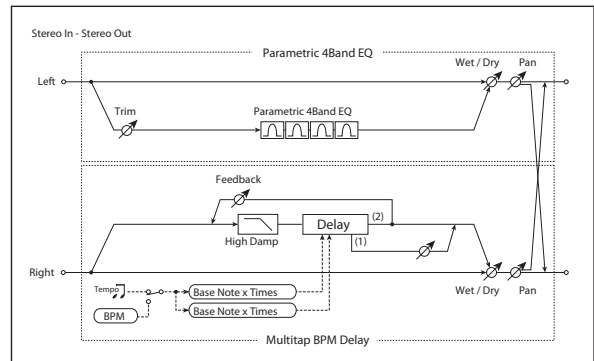

150: Comp // Comp

This effect connects two compressors in parallel. The pan and effect balance can be adjusted independently for each.

For detailed information on the effects parameters, see “Compressor” on page 878.

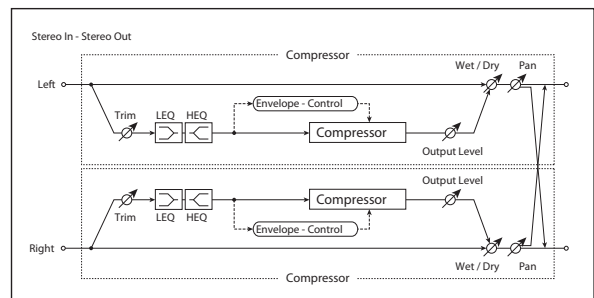

151: Comp // Limiter

This effect connects a compressor and a limiter in parallel. The pan and effect balance can be adjusted independently for each.

For detailed information on the effects parameters, see “Compressor” on page 878 and “Limiter” on page 878.

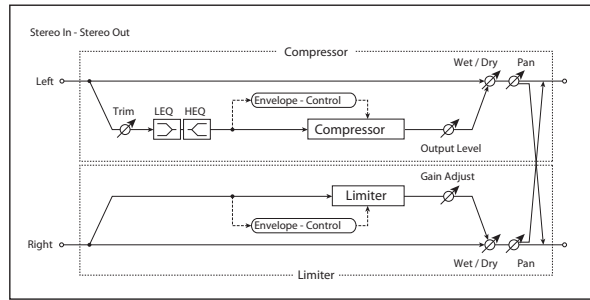

152: Comp // Exciter

This effect connects a compressor and an exciter in parallel. The pan and effect balance can be adjusted independently for each.

For detailed information on the effects parameters, see “Compressor” on page 878 and “Exciter” on page 879.

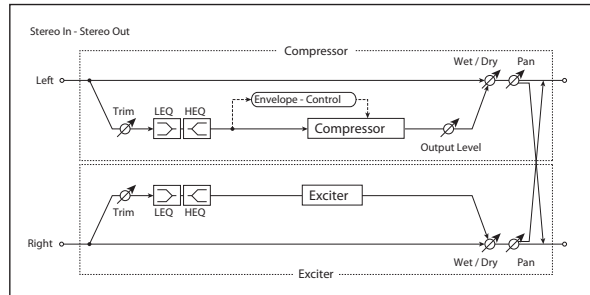

153: Comp // OD/Hi Gain

This effect connects a compressor and an overdrive in parallel. The pan and effect balance can be adjusted independently for each.

For detailed information on the effects parameters, see “Compressor” on page 878 and “OD/HI-GAIN” on page 879.

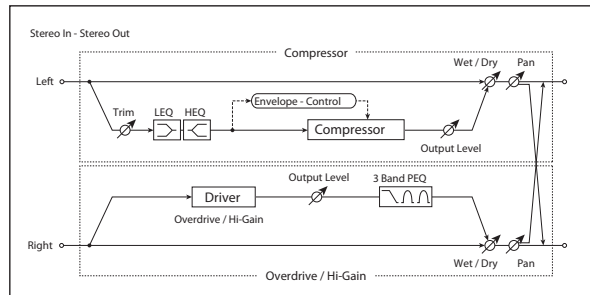

154: Comp // Wah

This effect connects a compressor and a wah in parallel. The pan and effect balance can be adjusted independently for each.

For detailed information on the effects parameters, see “Compressor” on page 878 and “WAH” on page 879.

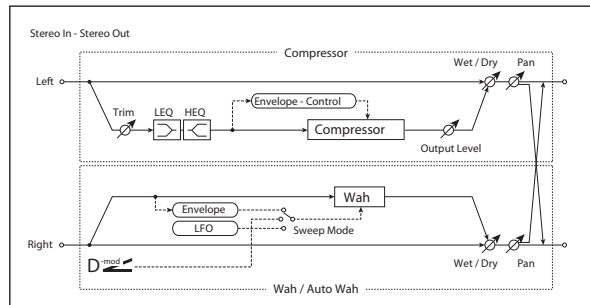

155: Comp // Chorus/Flanger

This effect connects a compressor and a chorus / flanger in parallel. The pan and effect balance can be adjusted independently for each.

For detailed information on the effects parameters, see “Compressor” on page 878 and “Chorus/Flanger” on page 880.

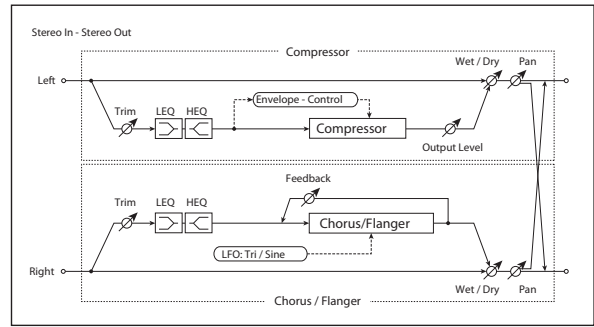

156: Comp // Phaser

This effect connects a compressor and a phaser in parallel. The pan and effect balance can be adjusted independently for each.

For detailed information on the effects parameters, see “Compressor” on page 878 and “Phaser” on page 880.

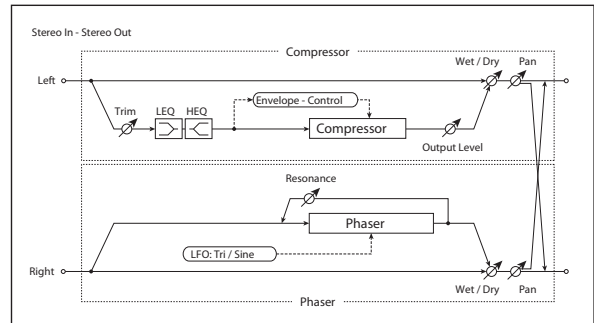

157: Comp // Multitap BPM Dly

This effect connects a compressor and a multitap BPM delay in parallel. The pan and effect balance can be adjusted independently for each.

For detailed information on the effects parameters, see “Compressor” on page 878 and “Multi-tap BPM Delay” on page 880.

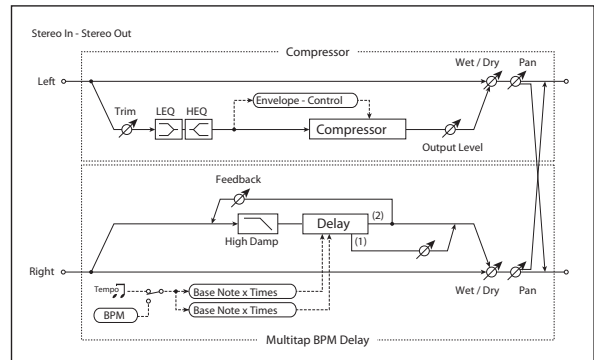

158: Limiter // Limiter

This effect connects two limiters units in parallel. The pan and effect balance can be adjusted independently for each.

For detailed information on the effects parameters, see “Limiter” on page 878.

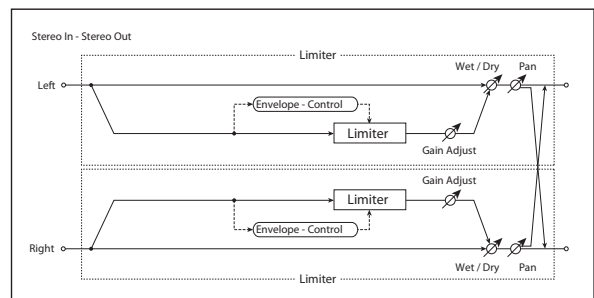

159: Limiter // Exciter

This effect connects a limiter and an exciter in parallel. The pan and effect balance can be adjusted independently for each.

For detailed information on the effects parameters, see “Limiter” on page 878 and “Exciter” on page 879.

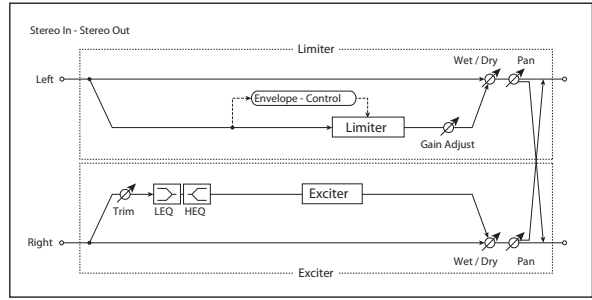

160: Limiter // OD/Hi Gain

This effect connects a limiter and an overdrive in parallel. The pan and effect balance can be adjusted independently for each.

For detailed information on the effects parameters, see “Limiter” on page 878 and “OD/Hi-GAIN” on page 879.

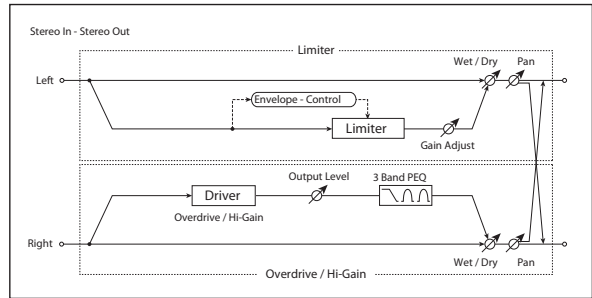

161: Limiter // Wah

This effect connects a limiter and a wah in parallel. The pan and effect balance can be adjusted independently for each.

For detailed information on the effects parameters, see “Limiter” on page 878 and “WAH” on page 879.

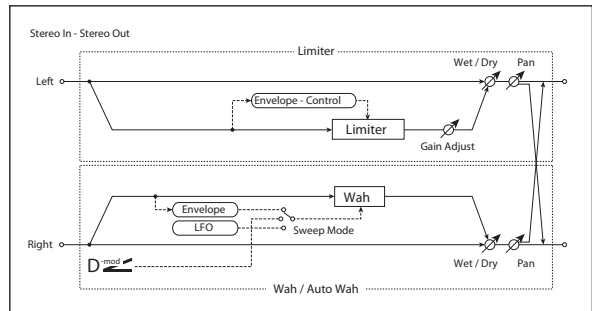

162: Limiter // Chorus/Flanger

This effect connects a limiter and a chorus/flanger in parallel. The pan and effect balance can be adjusted independently for each.

For detailed information on the effects parameters, see “Limiter” on page 878 and “Chorus/Flanger” on page 880.

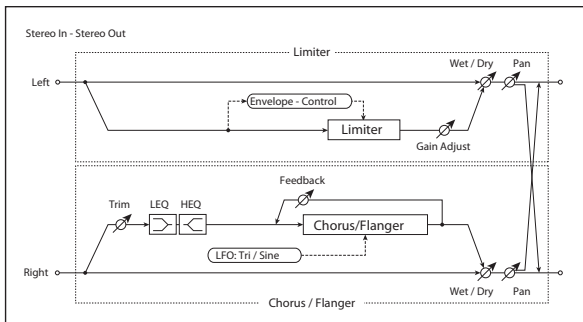

163: Limiter // Phaser

This effect connects a limiter and a phaser in parallel. The pan and effect balance can be adjusted independently for each.

For detailed information on the effects parameters, see “Limiter” on page 878 and “Phaser” on page 880.

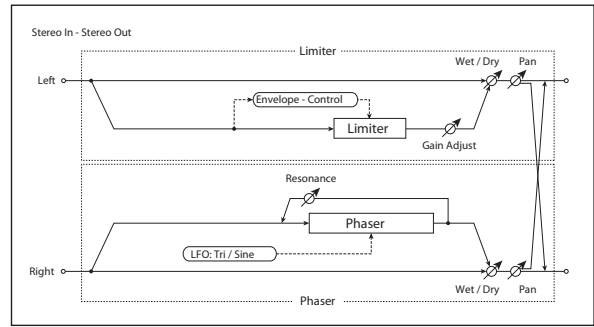

164: Limiter // Mtap BPM Dly

This effect connects a limiter and a multitap BPM delay in parallel. The pan and effect balance can be adjusted independently for each.

For detailed information on the effects parameters, see “Limiter” on page 878 and “Multi-tap BPM Delay” on page 880.

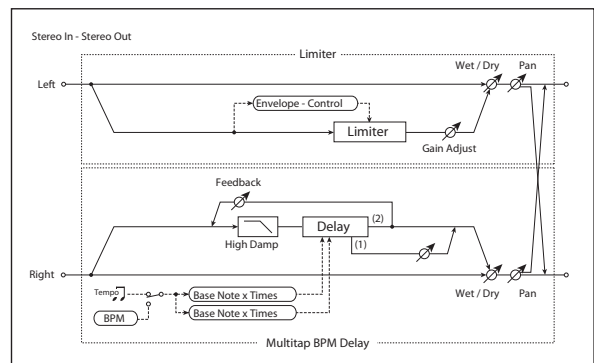

165: Exciter // Exciter

This effect connects two exciters in parallel. The pan and effect balance can be adjusted independently for each.

For detailed information on the effects parameters, see “Exciter” on page 879.

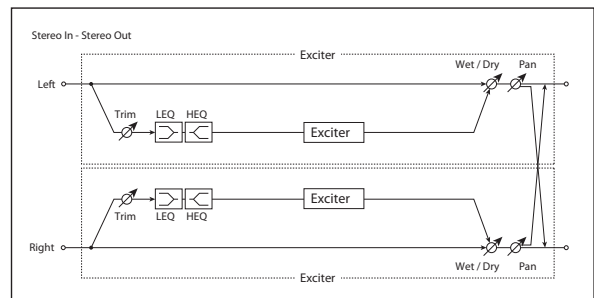

166: Exciter // OD/Hi Gain

This effect connects an exciter and an overdrive in parallel. The pan and effect balance can be adjusted independently for each.

For detailed information on the effects parameters, see “Exciter” on page 879 and “OD/HI-GAIN” on page 879.

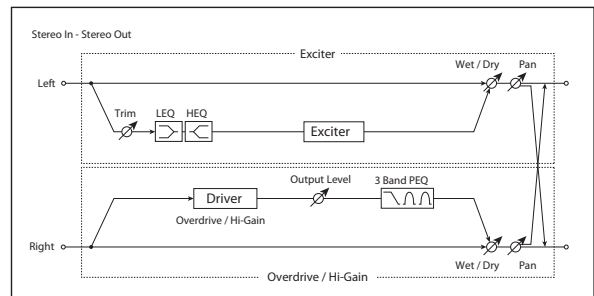

167: Exciter // Wah

This effect connects an exciter and a wah in parallel. The pan and effect balance can be adjusted independently for each.

For detailed information on the effects parameters, see “Exciter” on page 879 and “WAH” on page 879.

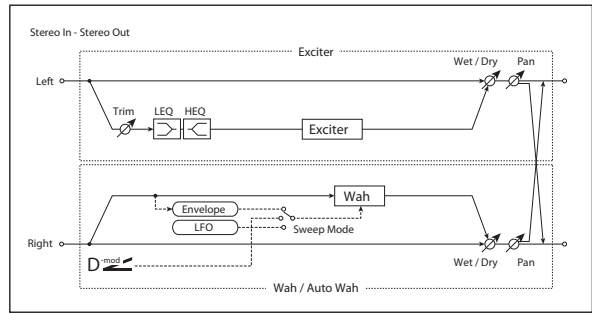

168: Exciter // Chorus/Flanger

This effect connects an exciter and a chorus/flanger in parallel. The pan and effect balance can be adjusted independently for each.

For detailed information on the effects parameters, see “Exciter” on page 879 and “Chorus/Flanger” on page 880.

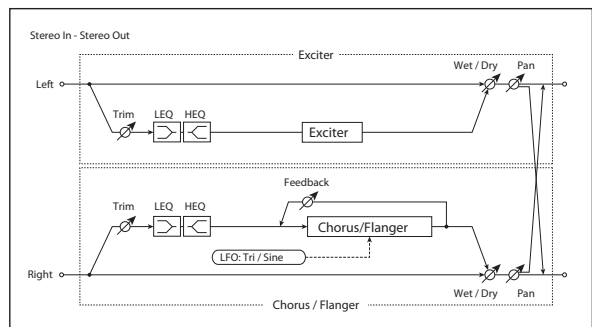

169: Exciter // Phaser

This effect connects an exciter and a phaser in parallel. The pan and effect balance can be adjusted independently for each.

For detailed information on the effects parameters, see “Exciter” on page 879 and “Phaser” on page 880.

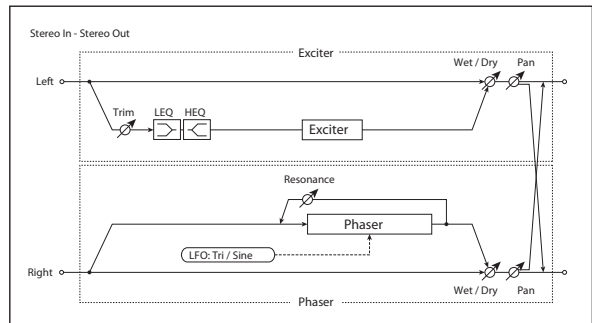

170: Exciter // Mtap BPM Dly

This effect connects an exciter and a multitap BPM delay in parallel. The pan and effect balance can be adjusted independently for each.

For detailed information on the effects parameters, see “Exciter” on page 879 and “Multi-tap BPM Delay” on page 880.

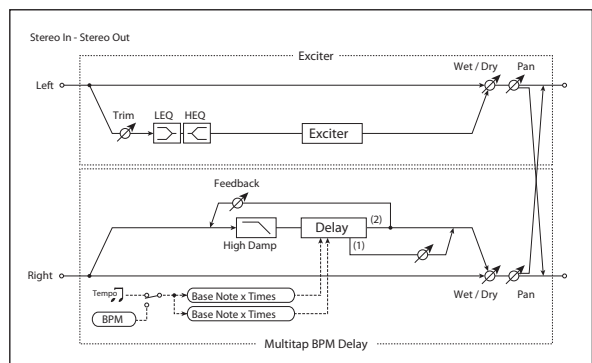

171: OD/Hi Gain // OD/Hi Gain

This effect connects two overdrives in parallel. The pan and effect balance can be adjusted independently for each.

For detailed information on the effects parameters, see “OD/HI-GAIN” on page 879.

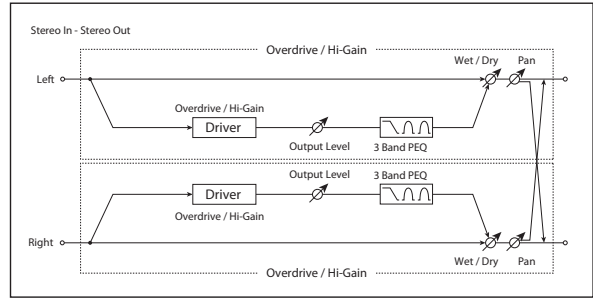

172: OD/Hi Gain // Wah

This effect connects an overdrive and a wah in parallel. The pan and effect balance can be adjusted independently for each.

For detailed information on the effects parameters, see “OD/HI-GAIN” on page 879 and “WAH” on page 879.

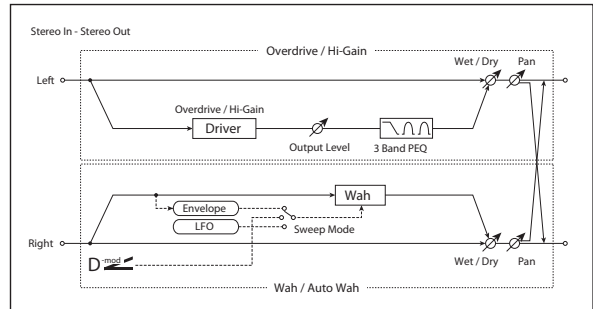

173: OD/Hi Gain // Cho/Flanger

This effect connects an overdrive and a chorus / flanger in parallel. The pan and effect balance can be adjusted independently for each.

For detailed information on the effects parameters, see “OD/HI-GAIN” on page 879 and “Chorus/Flanger” on page 880.

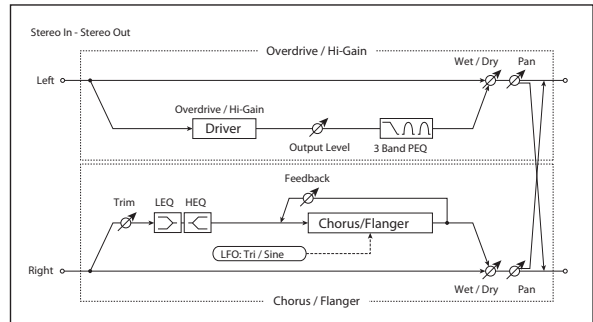

174: OD/Hi Gain // Phaser

This effect connects an overdrive and a phaser in parallel. The pan and effect balance can be adjusted independently for each.

For detailed information on the effects parameters, see “OD/HI-GAIN” on page 879 and “Phaser” on page 880.

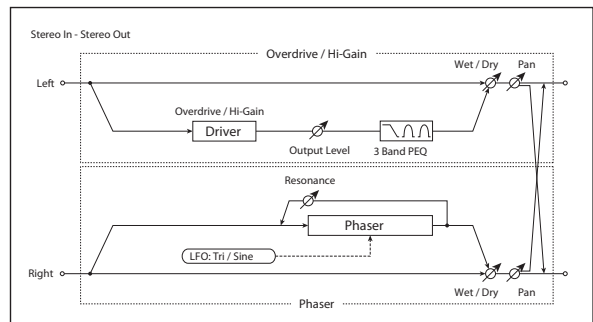

175: OD/Hi Gain // Mt BPM Dly

This effect connects an overdrive and a multitap BPM delay in parallel. The pan and effect balance can be adjusted independently for each.

For detailed information on the effects parameters, see “OD/HI-GAIN” on page 879 and “Multi-tap BPM Delay” on page 880.

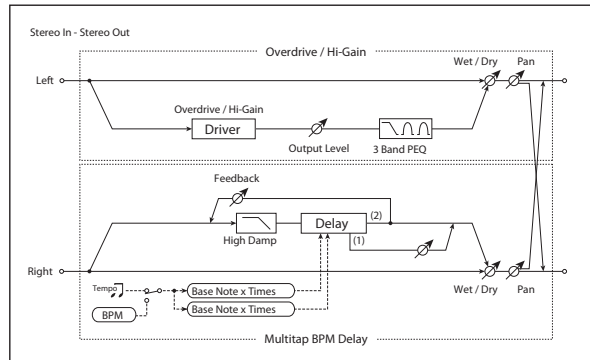

176: Wah // Wah

This effect connects two wahs in parallel. The pan and effect balance can be adjusted independently for each.

For detailed information on the effects parameters, see “WAH” on page 879.

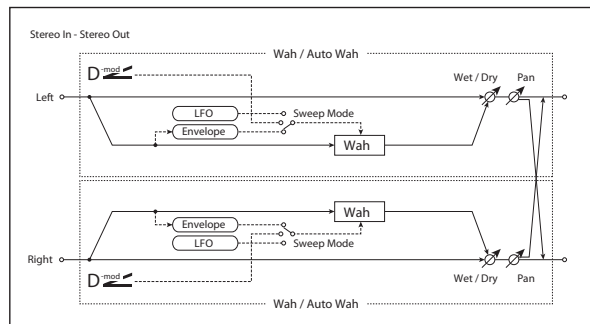

177: Wah // Chorus/Flanger

This effect connects a wah and a chorus/flanger in parallel. The pan and effect balance can be adjusted independently for each.

For detailed information on the effects parameters, see “WAH” on page 879 and “Chorus/Flanger” on page 880.

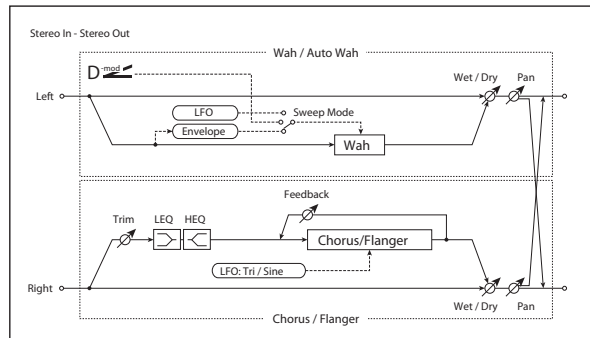

178: Wah // Phaser

This effect connects a wah and a phaser in parallel. The pan and effect balance can be adjusted independently for each.

For detailed information on the effects parameters, see “WAH” on page 879 and “Phaser” on page 880.

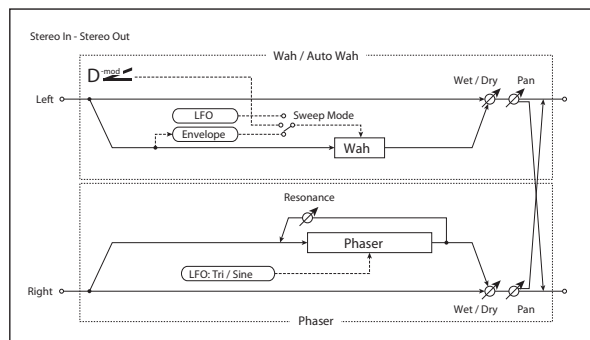

179: Wah // Multitap BPM Dly

This effect connects a wah and a multitap BPM delay in parallel. The pan and effect balance can be adjusted independently for each.

For detailed information on the effects parameters, see “WAH” on page 879 and “Multi-tap BPM Delay” on page 880.

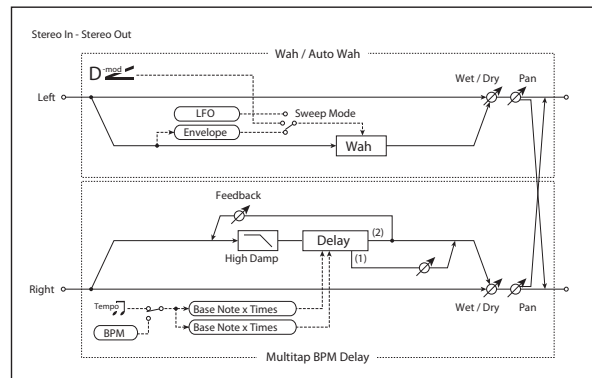

180: Cho/Flange // Cho/Flanger

This effect connects two chorus/flangers in parallel. The pan and effect balance can be adjusted independently for each.

For detailed information on the effects parameters, see “Chorus/Flanger” on page 880.

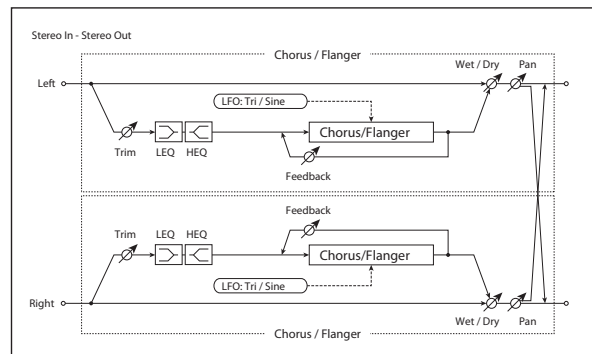

181: Cho/Flange // Phaser

This effect connects a chorus/flanger and a phaser in parallel. The pan and effect balance can be adjusted independently for each.

For detailed information on the effects parameters, see “Chorus/Flanger” on page 880 and “Phaser” on page 880.

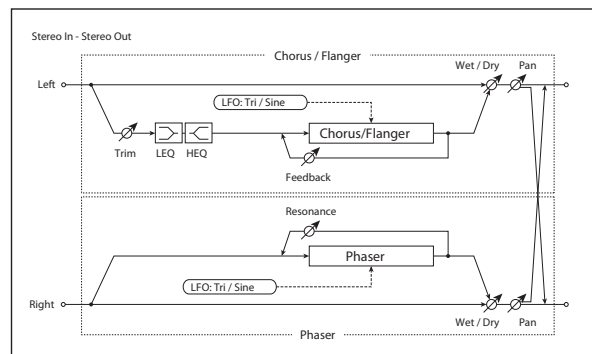

182: Cho/Flange // Mt BPM Dly

This effect connects a chorus / flanger and a multitap BPM delay in parallel. The pan and effect balance can be adjusted independently for each.

For detailed information on the effects parameters, see “Chorus/Flanger” on page 880 and “Multi-tap BPM Delay” on page 880.

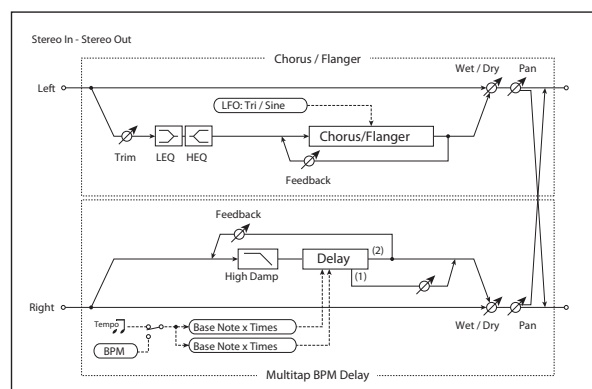

183: Phaser // Phaser

This effect connects two phasers in parallel. The pan and effect balance can be adjusted independently for each.

For detailed information on the effects parameters, see “Phaser” on page 880.

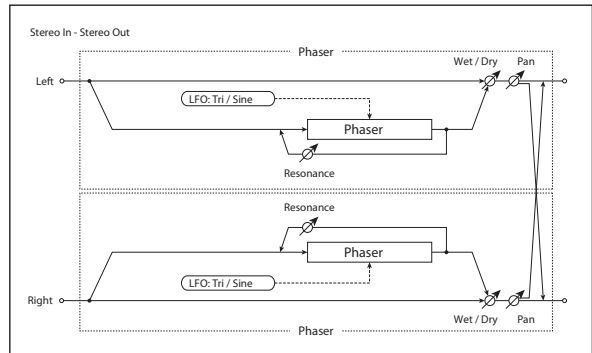

184: Phaser // Mtap BPM Dly

This effect connects a phaser and a multitap BPM delay in parallel. The pan and effect balance can be adjusted independently for each.

For detailed information on the effects parameters, see “Phaser” on page 880 and “Multi-tap BPM Delay” on page 880.

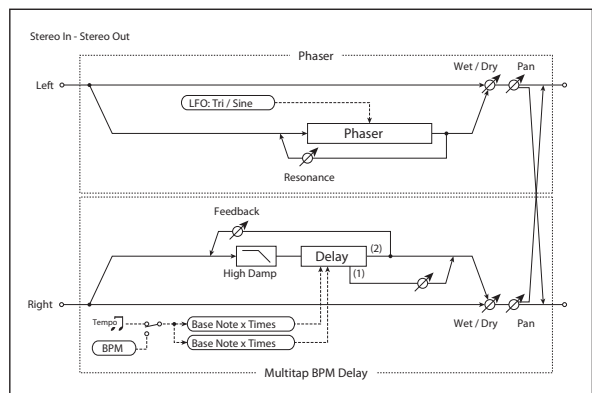

185: Mt.BPM Dly // Mt.BPM Dly

This effect connects two multitap BPM delays in parallel. The pan and effect balance can be adjusted independently for each.

For detailed information on the effects parameters, see “Multi-tap BPM Delay” on page 880.

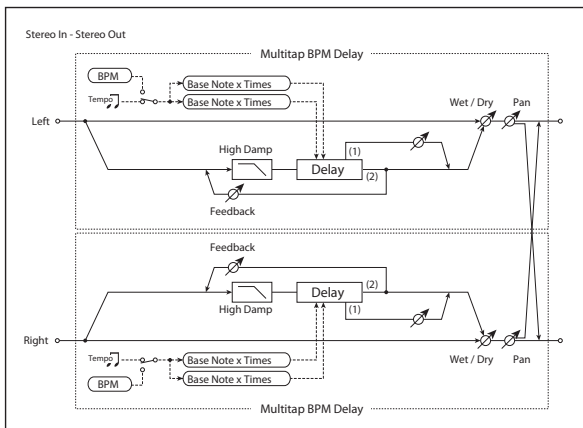

Vintage

186: Small Phase

This classic phaser, made in New York City during the 70s, has a notably warm and rich tone with liquid transparency.

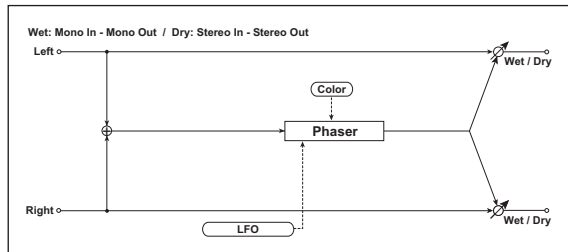

PHASER

Color [Off, On]

This changes the sound of the phaser between a full and round phase shift when set to **Off**, and a more pronounced effect when set to **On**.

187: Orange Phase

This phaser pedal is a favorite on many recordings. It's useful for adding sparkle, animating chord passages, and widening and fattening the sound.

The original had only a speed control; this version adds depth, control of the center frequency, and more.

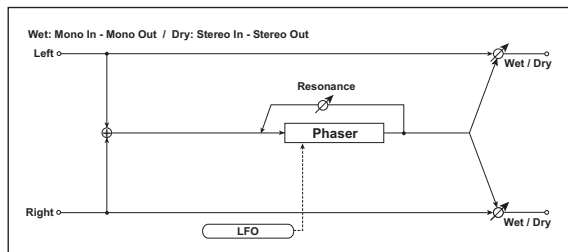

PHASER

Depth D_{mod} [0...100]

Sets the depth of LFO modulation.

Source [List of Dmod Sources]

This selects a modulation source to control the LFO modulation **Depth**.

Amount [-100...+100]

This controls the depth and direction of the **Depth** modulation.

Resonance [000...100]

This controls the intensity of the phaser effect. Mixing the processed and dry signals via **Wet/Dry** will enhance the effect.

Manual [1...100]

This sets the center frequency of the phaser.

LFO

Speed [Hz] [0.10...10.00]

This controls the speed of the phaser's LFO.

Source [List of Dmod Sources]

This selects a mod source to control the **Speed**. For a list of Dmod sources, see the "Dynamic Modulation Source List" on page 912.

Amount [-10.0...+10.0]

This controls the depth and direction of the **Speed** modulation.

OUTPUT

This is the standard effects output section, with modulatable control over wet/dry balance. For more information, see "OUTPUT" on page 764.

LFO

Speed [Hz] [0.10...10.00]

This controls the speed of the phaser's LFO.

Source [List of Dmod Sources]

This selects a modulation source to control the **Speed**. For a list of Dmod sources, see the "Dynamic Modulation Source List" on page 912.

Amount [-10.0...+10.0]

This controls the depth and direction of the **Speed** modulation.

OUTPUT

This is the standard effects output section, with modulatable control over wet/dry balance. For more information, see "OUTPUT" on page 764.

188: Black Phase

Inspired by a classic European phaser pedal.

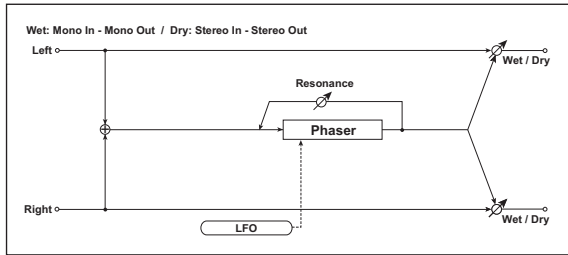

PHASER

Depth  [0...100]

Sets the depth of LFO modulation.

Source [List of Dmod Sources]

This selects a modulation source to control the LFO modulation **Depth**.

Amount [-100...+100]

This controls the depth and direction of the **Depth** modulation.

Resonance [000...100]

This controls the intensity of the phaser effect. Mixing the processed and dry signals via **Wet/Dry** will enhance the effect.

Manual [1...100]

This sets the center frequency of the phaser.

LFO

Speed [Hz] [0.10...10.00]

This controls the speed of the phaser's LFO.

Source [List of Dmod Sources]

This selects a modulation source to control the **Speed**. For a list of Dmod sources, see the "Dynamic Modulation Source List" on page 912.

Amount [-10.0...+10.0]

This controls the depth and direction of the **Speed** modulation.

OUTPUT

This is the standard effects output section, with modulatable control over wet/dry balance. For more information, see "OUTPUT" on page 764.

189: Vintage Chorus

This models a chorus best-known for being built into a guitar amp. You can use the **Speed** and **Depth** for an even broader range of possibilities than on the original device.

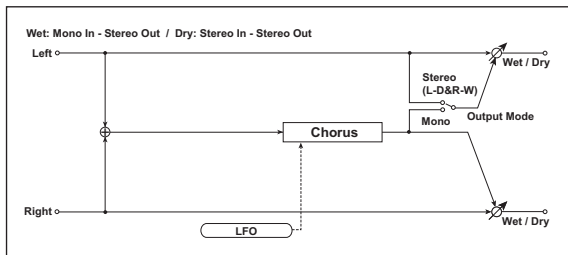

CHORUS

Depth  [0...100]

Sets the depth of LFO modulation.

Source [List of Dmod Sources]

This selects a modulation source to control the **Depth**.

Amount [-100...+100]

This controls the depth and direction of the **Depth** modulation.

Manual [1...100]

This adjusts the offset of the LFO sweep, effectively increasing the center delay time of the chorus.

When **Depth** is set to the maximum of **100**, this has no effect.

Output Mode [Mono, Stereo]

The chorus can function either in mono or stereo.

LFO

Speed [Hz] [0.10...10.00]

This controls the speed of the chorus' LFO.

Source [List of Dmod Sources]

This selects a modulation source to control the **Speed**. For a list of Dmod sources, see the "Dynamic Modulation Source List" on page 912.

Amount [-10.0...+10.0]

This controls the depth and direction of the **Speed** modulation.

OUTPUT

This is the standard effects output section, with modulatable control over wet/dry balance. For more information, see "OUTPUT" on page 764.

190: Black Chorus

Modeled after a classic stereo chorus known for both crystal-clean tone and quiet operation, and especially well-suited to fine electric pianos.

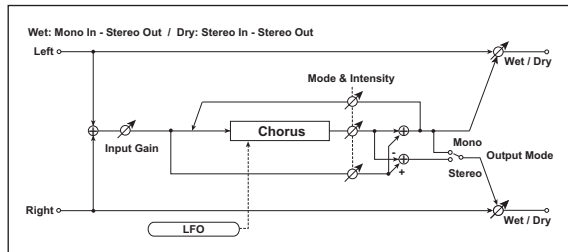

CHORUS

Intensity D_{mod} [1...100]

This controls different things, depending on the **Mode** setting (see below).

When **Mode** is set to Chorus, **Intensity** blends between the wet and dry signals.

When **Mode** is set to Pitch Modulation, **Intensity** blends between chorus (at 0) and vibrato (at 100).

When **Mode** is set to Flanger, **Intensity** controls the feedback amount.

Source [List of Dmod Sources]

This selects a modulation source to control the **Intensity**.

Amount [-100...+100]

This controls the depth and direction of the **Intensity** modulation.

Width [0...100]

This controls the amount of LFO modulation.

Source [List of Dmod Sources]

This selects a modulation source to control the **Width**.

Amount [-100...+100]

This controls the depth and direction of the **Width** modulation.

LFO

Speed [Hz] [0.10...10.00]

This controls the speed of the LFO.

Source [List of Dmod Sources]

This selects a modulation source to control the **Speed**. For a list of Dmod sources, see the “Dynamic Modulation Source List” on page 912.

Amount [-10.0...+10.0]

This controls the depth and direction of the **Speed** modulation.

MODE

Mode [Chorus, Pitch Modulation, Flanger]

This controls the basic sound of the effect.

Chorus is a standard chorus sound.

Pitch Modulation is a lighter chorus effect.

Flanger adds feedback, for more extreme timbres.

Input Gain [0...100]

This controls the input into the effect. High levels will add saturation.

Output Mode [Mono, Stereo]

This controls whether the output is stereo or mono. When set to **Stereo**, the left-right spread is controlled by the **Width** parameter.

OUTPUT

Wet/Dry D_{mod} [Dry, 1: 99...99:1, Wet]

Sets the balance between the “wet” processed sound and the dry input.

Note: When **Mode** is set to **Chorus**, the **Intensity** control is the same as **Wet/Dry**.

Source [List of Dmod Sources]

Selects a modulation source for **Wet/Dry**.

Amount [-100...+100]

Sets the modulation amount for **Wet/Dry**.

191: EP Chorus

This is inspired by a rare chorus built into an early version of a famous modified tine piano.

CHORUS

Depth D_{mod} [0...100]

This sets the depth of LFO modulation.

Source [List of Dmod Sources]

This selects a modulation source to control the **Depth**.

Amount [-100...+100]

This controls the depth and direction of the **Depth** modulation.

LFO

Speed [Hz] [0.10...10.00]

This controls the speed of the chorus’ LFO.

Source [List of Dmod Sources]

This selects a modulation source to control the **Speed**. For a list of Dmod sources, see the “Dynamic Modulation Source List” on page 912.

Amount [-10.0...+10.0]

This controls the depth and direction of the **Speed** modulation.

192: Vintage Flanger

A model of a truly classic analogue flanger. This amazing stompbox’s bucket-brigade technology provides a sweeping, whooshing sound, perfect for chords.

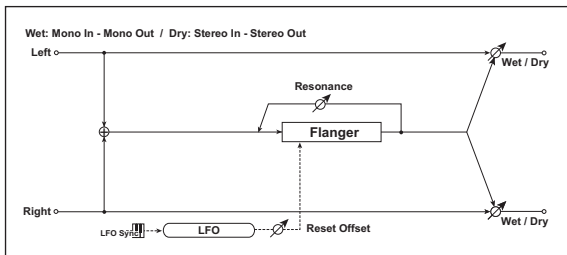

LFO

Speed [Hz] [0.10...10.00]

This controls the speed of the LFO.

Source [List of Dmod Sources]

This selects a modulation source to control the **Speed**. For a list of Dmod sources, see the “Dynamic Modulation Source List” on page 912.

Amount [-10.0...+10.0]

This controls the depth and direction of the **Speed** modulation.

LFO Reset Source [List of Dmod Sources]

This selects a modulation source to reset the LFO. You can use this to re-start the flanger’s jet-like, rolling motion just before a big power chord, for instance. This will be most useful when the **Speed** is set relatively low.

Reset Offset Amount [0...100]

This controls the phase of the LFO when reset.

193: Red Comp

Need to play clean chordal passages with smooth, even dynamics? Then, look no further: this compressor is modeled on a pedal whose clean sound made it hugely popular. Perfect for pop and funk music.

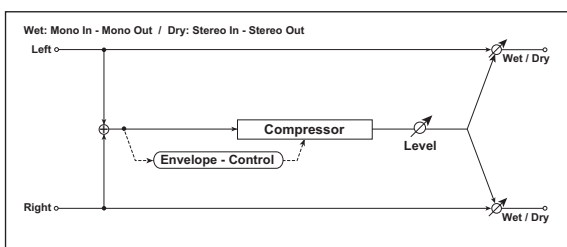

OUTPUT

This is the standard effects output section, with modulatable control over wet/dry balance. For more information, see “OUTPUT” on page 764.

FLANGER

Depth [0...100]

Sets the depth of LFO modulation.

Source [List of Dmod Sources]

This selects a modulation source to control the **Depth**.

Amount [-100...+100]

This controls the depth and direction of the **Depth** modulation.

Resonance [0...100]

This controls the intensity of the flanger effect, via feedback.

Manual [1...100]

This adjusts the offset of the LFO sweep, effectively increasing the center delay time of the chorus.

When **Depth** is set to the maximum of 100, this has no effect.

Source [List of Dmod Sources]

This selects a modulation source to control the **Manual** amount.

Amount [-100...+100]

This controls the depth and direction of the **Manual** modulation.

OUTPUT

This is the standard effects output section, with modulatable control over wet/dry balance. For more information, see “OUTPUT” on page 764.

COMPRESSOR

Sensitivity [1...100]

This controls the amount of compression. Increasing the value boosts lower level sounds, and raises the overall volume.

To adjust the final volume, use the **Output Level** parameter.

Attack [1...100]

This controls the onset time of the compressor.

Level [0...100]

Compression reduces the overall gain of the signal. This allows you to compensate for that effect, by boosting the gain again at the output.

OUTPUT**Wet/Dry**  [Dry, 1:99...99:1, Wet]

Sets the balance between the “wet” processed sound and the dry input.

194: Vox Wah

This effect is modeled on two legendary VOX wah pedals: the V847 and the V848 Clyde McCoy model. Thanks to their unique “throaty” tone, these are the only wah pedals that many professionals will consider putting under their feet. Played musically, they can make your melody lines cry like a baby—or howl like a man possessed!

A great tonal trick is to find a “sweet spot” within the range of the Wah pedal and then leave it there. This “stuck-Wah” can be very effective when used tastefully, producing a distinctive sound that will cut through any mix.

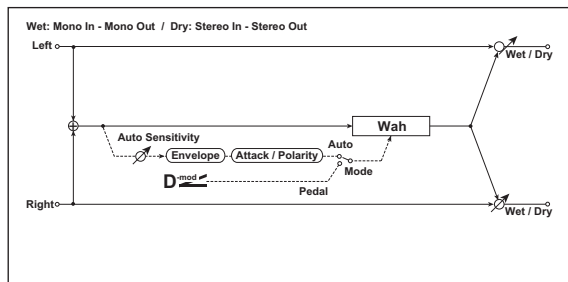
**CONTROL****Mode** [Pedal Wah, Auto Wah]

This controls the basic operation of the wah, and also determines which parameters appear below.

Auto Wah makes the wah follow the input signal’s volume envelope.

Pedal Wah lets you control the wah frequency directly via a modulation source, just like a wah pedal.

Pedal Wah

These parameters apply only when the **Mode** is set to **Pedal Wah**.

Source [List of Dmod Sources]

This selects a modulation source to control the wah frequency.

Manual [1...100]

This sets the default value of the pedal, before the selected modulation source is moved. Once the source has been moved, **Pedal Manual** has no effect.

Auto Wah

These parameters apply only when the **Mode** is set to **Auto Wah**.

Source [List of Dmod Sources]

Selects a modulation source for **Wet/Dry**.

Amount [-100...+100]

Sets the modulation amount for **Wet/Dry**.

Sensitivity [0...100]

This sets the sensitivity of auto-wah. Increase the value if the input signal is too low to sweep the wah. Reduce the value if the input signal is so high that the sweep stops temporarily.

Attack [1...100]

This controls the reaction time of the auto-wah.

Polarity [Up, Down]

This controls whether the auto-wah sweeps from open to closed, or from closed to open.

WAH**Type** [V847, V848]

This selects the pedal model.

V847 has a rounder sound; **V848** has a more aggressive sound.

Open [1...100]

This sets the wah frequency when the pedal is up.

Close [1...100]

This sets the wah frequency when the pedal is down.

OUTPUT**Wet/Dry**  [Dry, 1:99...99:1, Wet]

Sets the balance between the “wet” processed sound and the dry input.

Source [List of Dmod Sources]

Selects a modulation source for **Wet/Dry**.

Amount [-100...+100]

Sets the modulation amount for **Wet/Dry**.

195: Stereo EP Cabinet

This effect models the built-in speaker and amplifiers of a set of classic electric pianos, based on the amps and cabinets from the EP-1.

CABINET SIMULATOR

Type [Tine I, Tine II, Reed 200, Reed 200A]

This selects the cabinet model.

Drive [00...100]

This controls the amount of overdrive and distortion in the amp. At lower settings, the amp is very clean; as you increase the **Drive**, it gets dirtier and more distorted. The output level is compensated, so increasing **Drive** causes only a moderate increase in perceived volume.

196: Rotary Speaker Amp Model

This effect models the amplifier of a rotary speaker setup (not including the speakers themselves), based on the CX-3. You can use this in series with the separate effect “197: Rotary Speaker Pro CX Custom,” below.

EXPRESSION

Expression adjusts both the volume level and the amount of distortion. At lower Expression values, both the low bass and high treble frequencies are slightly emphasized.

To allow optimal modulation flexibility, the Dmod for Expression works differently from most other modulation. See **Mode**, below, for more details.

Expression Minimum [0...30]

This specifies the minimum level when **Expression Level** or **Expression Dmod** are at 0.

Expression Level [0...99]

This sets the default Expression level. It will be grayed out if the **Mode**, below, is set to **Dmod Only**.

Dmod [List of Dmod Sources]

This selects a Dmod source to modulate the **Expression Level**.

This parameter is grayed out if **Mode**, below, is set to **Level Only**.

NOTE: The MIDI Expression controller (CC #11) is hard-wired to scale the channel volume level. So, despite the similar name, it’s best to use another controller as a Dmod source.

Mode [Level Only, Dmod Only, Both Scale, Both Overwrite]

This controls how the Dmod interacts with the programmed **Expression Level**.

Level Only: The **Expression Level** parameter has complete control over Expression. The **Dmod** parameter is grayed out and has no affect.

Dmod Only: The Dmod input has complete control over Expression, while the **Expression Level** parameter is grayed out and has no affect.

Source [List of Dmod Sources]

This selects a modulation source to control the **Drive**.

Amount [-100...+100]

This controls the depth and direction of the **Drive** modulation.

OUTPUT

This is the standard effects output section, with modulatable control over wet/dry balance. For more information, see “OUTPUT” on page 764.

Both Scale: The values of **Expression Level** and Dmod are multiplied to produce the Expression level. For the math-friendly, a value of 99 is treated as 1.0.

Both Overwrite: **Expression Level** and **Dmod** both write directly to the Expression level. If the **Expression Level** parameter is updated, it directly controls Expression, and the last value from **Dmod** is ignored. If the **Dmod** input moves, it also directly controls Expression, and the setting of the **Expression Level** parameter is ignored.

Disconnected pedals

If the Foot Pedal is assigned to a Dmod source but a pedal is not physically connected to the NAUTILUS, the result is the same as if the pedal was pressed down all the way: the Dmod signal will be at its maximum value.

AMP

Type [Type 1, Type 2, Pre Amp]

This selects one of two amp models, or a direct line-out from the organ’s preamp.

Type 1 is a standard powered amp for organ, producing a warm, fat tone.

Type 2 yields a less colored tone, with more high frequencies than Type 1.

PreAmp is the sound of a direct line-out from the organ.

Gain [00...99]

This adjusts the gain when **Type** is set to **Type 1** or **Type 2**. It does not apply if the **Type** is set to **PreAmp**.

Expression also adjusts the drive into the Amp section. With higher **Gain** settings, you’ll get more overdrive and distortion as you increase the **Expression** amount. For more information, see “4-2b: Expression,” on page 188.

Source [List of Dmod Sources]

This selects a source to modulate the **Gain**.

Amount [-99...+99]

This controls the depth and direction of the **Gain** modulation.

EQ

Treble [-10...+10]

This adjusts the high frequency range of the amp.

Mid [-10...+10]

This adjusts the mid-frequency range of the amp.

Bass [-10...+10]

This adjusts the low frequency range of the amp.

OUTPUT

This is the standard effects output section, with modulatable control over wet/dry balance. For more information, see “OUTPUT” on page 764.

197: Rotary Speaker Pro CX Custom

This effect models a vintage rotary speaker, with detailed control over both timbre and behavior. It provides the same performance as the Rotary Speaker included in the updated CX-3. For more information, see “7-2: Rotary Speaker” on page 199.

If you’re layering two CX-3s together, you may wish to route both Programs through a single instance of this effect instead of using the Rotary Speakers within the individual Programs.

Rotary Speaker speed indicator

In PROGRAM, COMBINATION, SEQUENCER, and SET LIST modes, if there is an active Rotary Speaker, its current state (Fast, Slow, or Stop) is shown at the top of the display. For more information, see “Rotary Speaker speed indicator” on page 830.

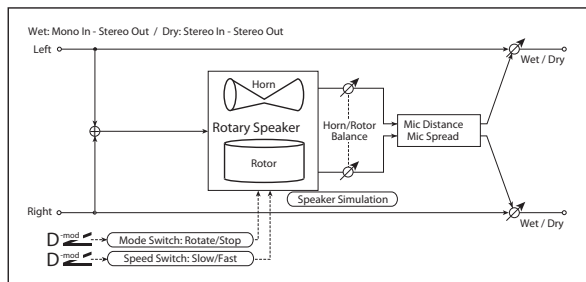

Mode [Toggle, Moment]

This determines the behavior of the **Speed Switch**. For more information, see “Mode” on page 831.

Fast Overrides Stop [Check-box]

On (checked): setting the **Speed Switch** to **Fast** will make the rotors speed up, even if the **Mode Switch** is set to **Stop**.

Off (un-checked): if the **Mode Switch** is set to **Stop**, the rotors will always stay stopped, regardless of the **Speed Switch**.

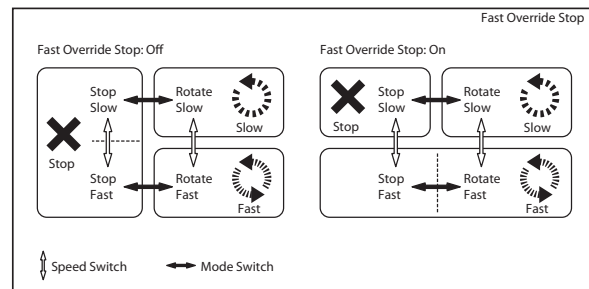

CONTROL

Mode Switch [Rotate, Stop]

This lets you stop the motion of the Rotary Speaker. Even when stopped, the speaker will still affect the timbre.

The horn and rotor can each take different amounts of time to start and stop their rotation. For more information, see the **Start Acceleration** and **Stop Deceleration** parameters under “HORN,” below.

Source [Off...Tempo]

This selects a modulation source to start and stop the Rotary Speaker.

Mode [Toggle, Moment]

This determines the behavior of the **Mode Switch**. For more information, see “Mode” on page 831.

Speed Switch [Slow, Fast]

Switches the speaker rotation speed between slow and fast

Source [Off...Tempo]

Selects a modulation source for Slow/Fast.

Horn Stop Phase [degrees] [Free, -180...+180]

When the **Mode Switch** is set to **Stop**, the Horn gradually comes to rest pointing one way or another. This allows you to control where it will stop.

Free lets it come to rest naturally, at a more or less random spot. The other settings, -180 to +180, let you force it to land in a specific position.

The speaker position has a dramatic effect on the tone, so specifying a fixed position allows you to achieve consistent timbral results.

Rotor Stop Phase [degrees] [Free, -180...+180]

This determines where the Rotor will land when the **Mode Switch** is set to **Stop**. For more details, see “Horn Stop Phase [degrees],” above.

HORN

The horn carries the effect's high frequencies, while the rotor carries the low frequencies.

Fast Speed [0...100]

This specifies the speed of the Horn when the **Speed Switch** is set to **Fast**.

Slow Speed [0...100]

This specifies the speed of the Horn when the **Speed Switch** is set to **Slow**.

Acceleration [0...100]

This sets how long it takes the Horn to change from the **Slow** speed to the **Fast** speed.

Deceleration [0...100]

This sets how long it takes the Horn to change from the **Fast** speed to the **Slow** speed.

Start Acceleration [0...100]

This sets how long it takes the Horn to come up to speed after the **Mode Switch** has changed from **Stop** to **Rotate**.

Stop Deceleration [0...100]

This sets how long it takes the horn to come to rest after the **Mode Switch** has changed from **Rotate** to **Stop**.

ROTOR

The rotor carries the low frequencies of the Rotary Speaker. Its parameters are identical to those of the Horn, above.

Fast Speed [0...100]

Slow Speed [0...100]

Acceleration [0...100]

Deceleration [0...100]

Start Acceleration [0...100]

Stop Deceleration [0...100]

Balance and Tone

Horn/Rotor Balance [Rotor, 1...99, Horn]

Sets the volume balance between the high-frequency horn and low-frequency rotor.

Speaker Simulator [Check-box]

Switches speaker simulation on/off.

Match CX-3 Tone [Amp 1, Amp 2]

When using this effect on a CX-3 Program, this setting will adjust the tone appropriately for the CX-3's Amp Type.

MIC

These settings model two pairs of stereo microphones recording the rotary speaker—one pair each for the horn and rotor. In the real world, this would require an elaborate setup, or even splitting the rotary speaker into two—but it's

relatively easy in the software world of the NAUTILUS, and it gives you separate control over the tone and stereo spread of the high and low frequencies.

The other rotary speaker effects have only one pair of mics, but are otherwise similar; for more information, see "MIC" on page 831.

Horn Distance [0...100]

Horn Spread [0...100]

Rotor Distance [0...100]

Rotor Spread [0...100]

OUTPUT

This is the standard effects output section, with modulatable control over wet/dry balance. For more information, see "OUTPUT" on page 764.

Appendices

Alternate Modulation Sources (AMS)

Alternate Modulation Overview

Alternate Modulation lets you use controllers, envelopes, LFOs, etc. to modulate Program parameters. They're called "Alternate Modulation" because they are in addition to the many dedicated modulation routings, such as Filter EG to Filter Cutoff, or LFO to Pitch.

You can use one controller to modulate multiple parameters simultaneously. You can also create complex modulation setups in which (for example) an envelope modulates the frequency of an LFO, and that LFO is then used to modulate a filter.

As shown in the diagrams below, the parameters you can control via alternate modulation will depend on the synth engine (HD-1, AL-1, CX-3 etc.). For each of these destination parameters, you can select an AMS (Alternate Modulation Source) to modulate it.

HD-1 Programs provide a total of 88 destinations for alternate modulation.

The EXi Common section provides 7 alternate modulation destinations, the AL-1 provides 92, the CX-3 provides 20, and the STR-1 provides 131 (not counting the AMS mixers). For information on other EXi, please see their individual documentation.

AMS Mixers

The AMS Mixers combine two AMS sources into one, or process an AMS source to make it into something new.

For instance, they can add two AMS sources together, or use one AMS source to scale the amount of another. You can also use them to change the shapes of LFOs and EGs in various ways, modify the response of realtime controllers, and more.

The AMS Mixer outputs appear in the list of AMS sources, just like the LFOs and EGs.

The original, unmodified inputs to the AMS Mixers are still available as well. For instance, if you use LFO 1 as an input to a AMS Mixer, you can use the processed version of the LFO to control one AMS destination, and the original version to control another.

Finally, you can cascade two or more AMS Mixers together, by one as an input to another.

For more information, see "6-1: OSC 1 AMS Mix" on page 89, and "Using the AMS Mixers" on page 44 of the OG.

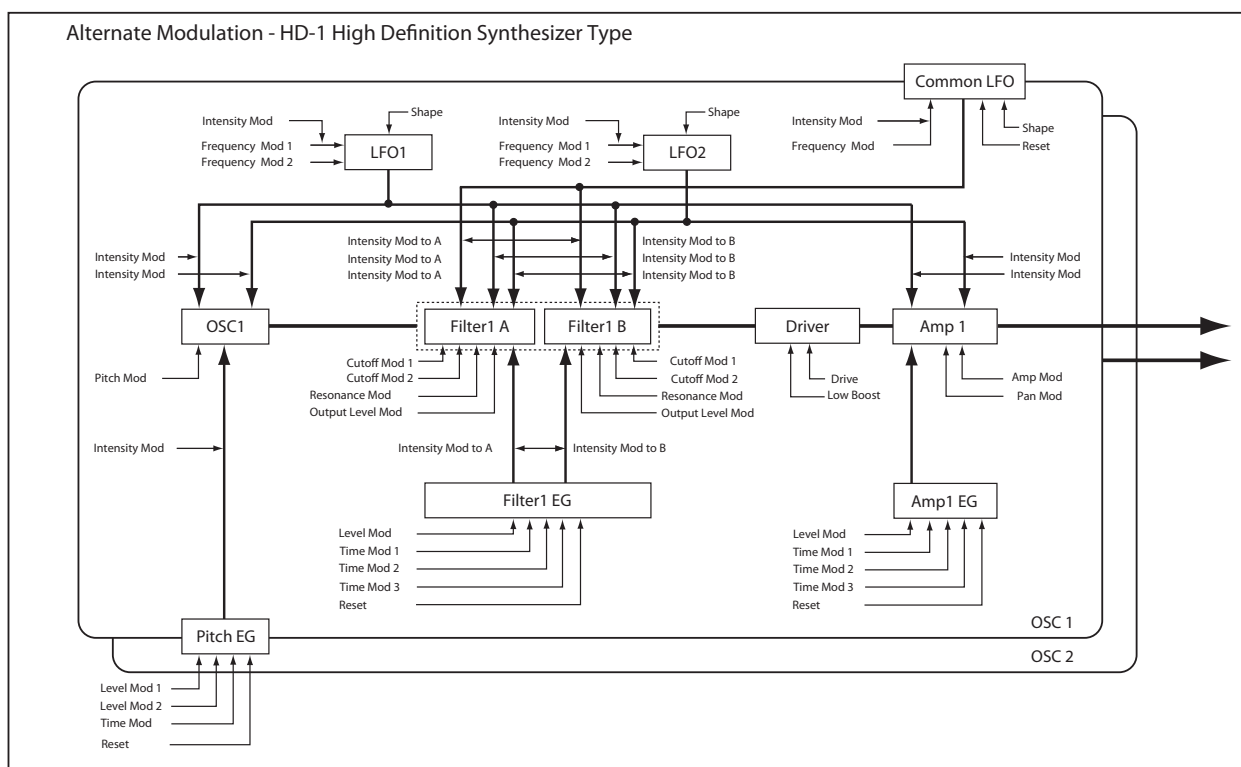

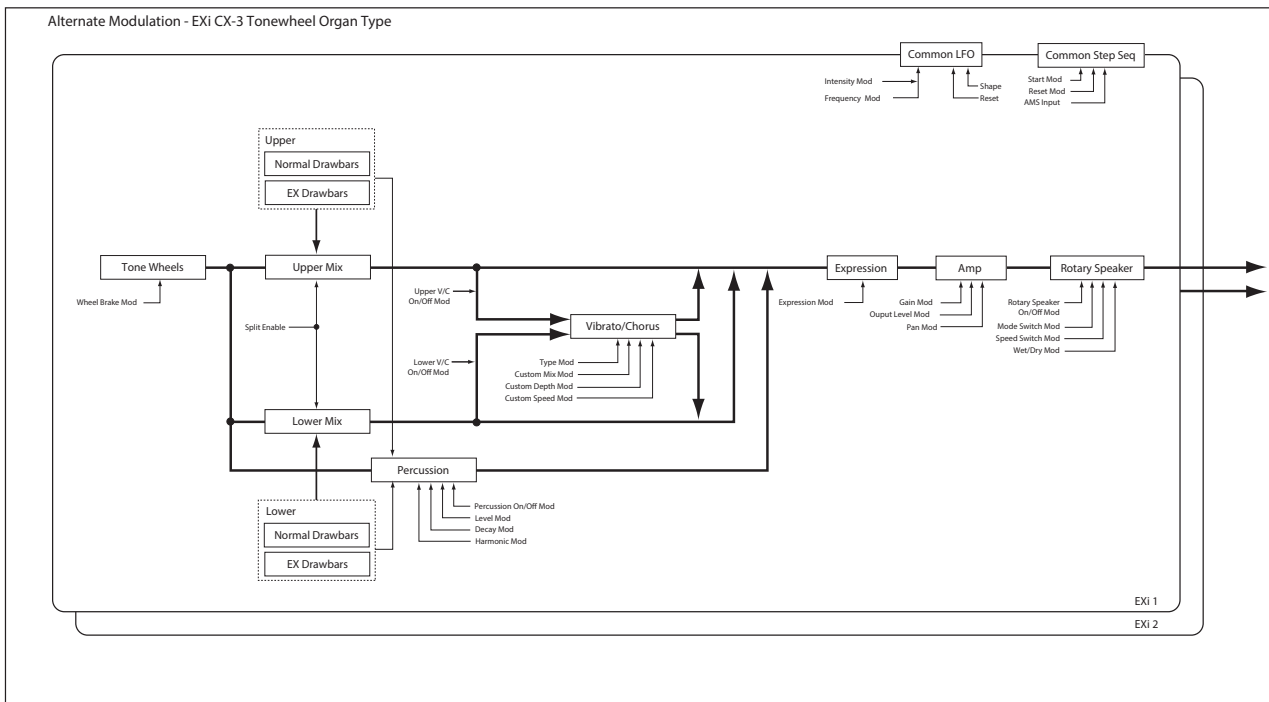
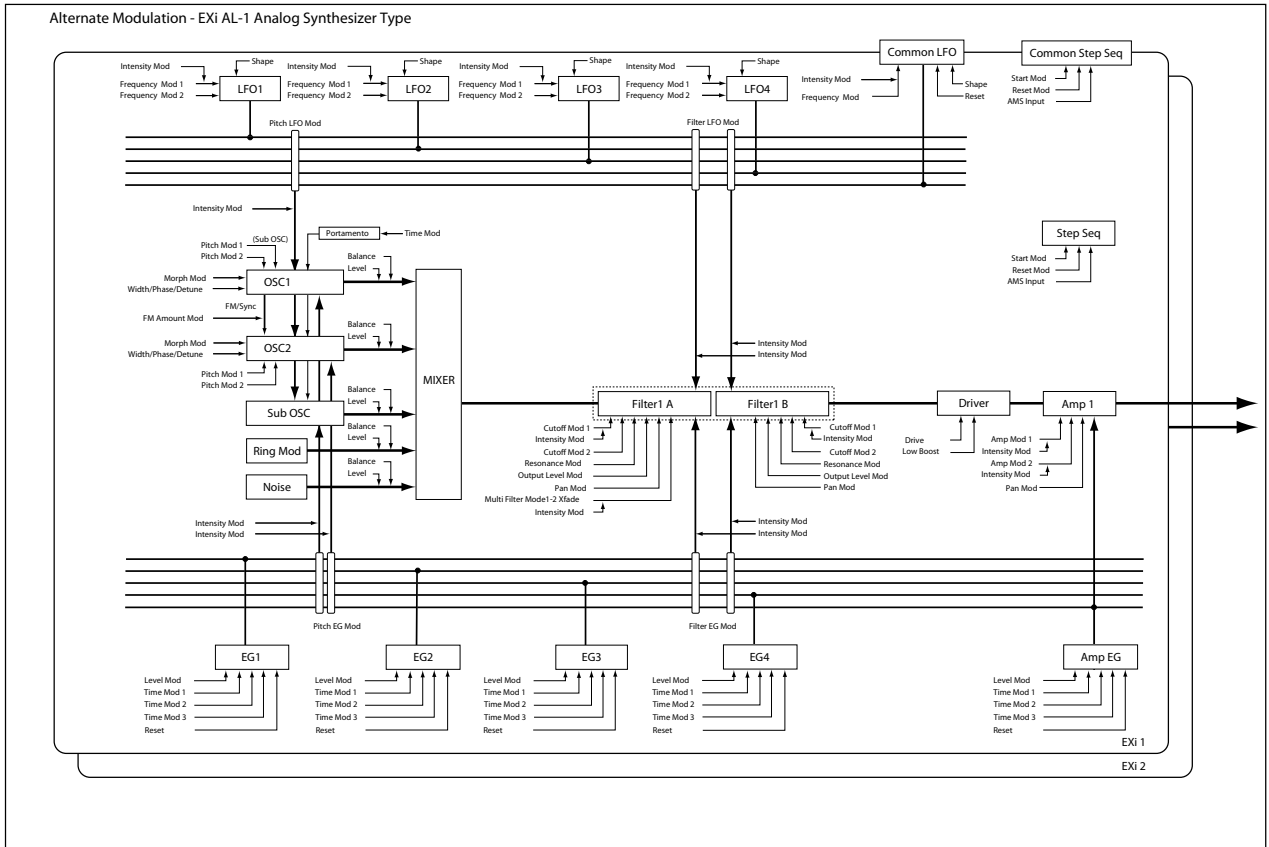

Alternate Modulation Source (AMS) List

Physical and MIDI controllers

Off

This means that no modulation source is selected.

Note Number

This is the note's MIDI note number, from 0 (C-2) to 127 (G9).

Velocity

This is the note's MIDI note-on velocity.

Exponential Velocity

This is MIDI note-on velocity through an exponential curve. The curve means that low velocities won't have very much effect, and the difference between two lower velocity values won't be very noticeable.

On the other hand, high velocities produce increasingly greater effects, and the difference between any two higher velocity values will be more pronounced.

Poly After Touch

Polyphonic aftertouch allows a different aftertouch value for each note. This can be received from external MIDI devices or generated by the internal sequencer. The NAUTILUS keyboard itself does not generate poly aftertouch, however.

After Touch

This receives MIDI Aftertouch, as well as aftertouch generated by pressing down on the NAUTILUS keyboard.

JS X

This is the horizontal movement of the main joystick. It also receives MIDI Pitchbend.

JS+Y (CC#01)

This is the vertical movement of the main joystick, upwards from the center. It also receives MIDI CC#01 (mod wheel).

JS-Y (CC#02)

This is the vertical movement of the main joystick, downwards from the center. It also receives MIDI CC#02 (breath controller).

JS +Y & AT/2 (Joy Stick +Y & After Touch/2)

The effect will be controlled by the joystick +Y (Vertical upward) and by after touch. In this case, the effect of after touch will be only half of the specified intensity.

JS -Y & AT/2 (Joy Stick -Y & After Touch/2)

The effect will be controlled by the joystick -Y (Vertical downward) and by after touch. In this case, the effect of after touch will be only half of the specified intensity.

Foot Pedal (CC#04)

This AMS source receives MIDI CC#04. It can also be generated by a foot pedal connected to the rear-panel ASSIGNABLE PEDAL input, if the Global **Foot Pedal Assign** parameter is set to Foot Pedal (CC#04). For more information, see "Foot Pedal Assignments" on page 919.

Control change 17 (CC#17)

This AMS source always responds to MIDI CC#17. For more information, see "Knob Mod.5 (CC#20)" on page 903.

Control change 18 (CC#18)

This AMS source always responds to MIDI CC#18.

Control change 19 (CC#19)

This AMS source always responds to MIDI CC#19. For more information, see "Control change 17 (CC#17)" on page 903.

Knob Mod.5 (CC#20)



This AMS source always responds to MIDI CC#20, and will usually also correspond to Knob 5 (USER 5).

A MIDI value of 0 (far left) causes the maximum negative modulation; 64 (center) means no modulation; and 127 (far right) causes the maximum positive modulation. (You can invert this response, if desired, by using a negative AMS intensity.)

It also usually corresponds to Knob 5 (USER 5) on the Control surface- but this depends on the Modulation Knob Assign settings for each individual Program, Combi, and Song.

Basically, there are two separate things: a physical knob named Knob 5, and an AMS source named "Control change 17 (CC#17)." This provides a great deal of flexibility—but it's also easy to link the two together. To do so:

1. Go to the current mode's Controllers page.
2. Set Knob 5's Modulation Knob Assign to Control change 17 (CC#17).

For more information, see "1-8: Controllers" on page 48, and "RT Control Knobs 1-6 Assignments" on page 916.

Knob Mod.6 (CC#21)

This AMS source always responds to MIDI CC#21, and will usually also correspond to Knob 6 (USER 6). For more information, see "Knob Mod.5 (CC#20)" on page 903.

Control change 17 [+] (CC#17)

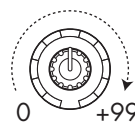

This is similar to "Control change 17 (CC#17)" on page 903, except that the range goes from 0 at the far left to +99 at the far right, corresponding to MIDI CC values of 0 and 127 respectively.

For more information, see "Knob Mod.5 (CC#20)" on page 903.

Control change 19 [+] (CC#19)

This is similar to “Control change 19 (CC#19)” on page 903, except that the range goes from 0 at the far left to +99 at the far right, corresponding to MIDI CC values of 0 and 127 respectively.

For more information, see “Knob Mod.5 (CC#20)” on page 903.

Knob Mod5 [+] (CC#20)

This is similar to “Knob Mod.5 (CC#20)” on page 903, except that the range goes from 0 at the far left to +99 at the far right, corresponding to MIDI CC values of 0 and 127 respectively.

For more information, see “Knob Mod.5 (CC#20)” on page 903.

Knob Mod6 [+] (CC#21)

This is similar to “Knob Mod.6 (CC#21)” on page 903, except that the range goes from 0 at the far left to +99 at the far right, corresponding to MIDI CC values of 0 and 127 respectively.

For more information, see “Knob Mod.5 (CC#20)” on page 903.

Damper (CC#64)

This is the Damper pedal, also sometimes called the sustain pedal. It corresponds to MIDI CC#64.

When using Korg’s optional half-damper pedal, the DS-1H, this AMS source is continuous—not just on/off.

Porta. SW (CC#65)

This is the MIDI portamento switch (CC#65), which also enables and disables portamento.

Sostenuto (CC#66)

This is the MIDI sostenuto pedal (CC#66).

Soft (CC#67)

This is the MIDI soft pedal (CC#67).

SW1 Mod. (CC#80)

This is CC#80, which is the default for assignable front-panel switch 1 (SW1). To use SW1 and SW2 as AMS sources:

1. Go to the Basic/X-Y/Controllers– Controllers - Switch page.
2. Under Panel Switch Assign, assign SW1 to SW1 Mod. (CC#80) and SW2 to SW2 Mod. (CC#81).

These assignments are stored separately for each Program, Combination, and Song.

For more information, see “SW1/2 Assignments” on page 915.

SW2 Mod. (CC#81)

This is CC#81, which is the default for assignable front-panel switch 2 (SW2). For more information, see “SW1 Mod. (CC#80),” above.

Foot Switch (CC#82)

This AMS source receives MIDI CC#82. It can also be generated by a foot switch connected to the rear-panel ASSIGNABLE SWITCH input, if the Global **Foot Pedal Assign** parameter is set to Foot Switch (CC#82). For more information, see “Foot Switch Assignments” on page 917.

Controller (CC#83)

MIDI control change (CC#83)

Tempo

This lets you use the system tempo as a modulation source. 120 is the center, for a value of 0; 60BPM is -99, and 240BPM is +99.

Note that this is different from actually syncing to tempo; for that purpose, use the dedicated synchronization functions for the LFOs, effects, etc.

Gate1 and Gate1+Damper

Gate 1 is triggered by a new note after all notes have been released, such as at the beginning of a phrase. Gate 1+Damper is similar, except that it is triggered by a new note-on after all notes and the damper are released.

You can use this to reset the Common LFO and Common Step Sequencer. For instance, to create an effect similar to the per-voice LFO and Step Sequencer’s **Key Sync Off** setting, use **Gate 1 + Damper** as the reset source.

Gate2 and Gate2+Damper

Gate 2 is similar to Gate 1, but it triggers with every new note-on, even in the middle of a legato phrase. Gate2+Damper includes the damper pedal in the equation, as shown in the diagram below.

Note: When used as a reset controller for Common LFO and Common Step Sequencer, Gate2 and Gate2+Damper will have the same effect.

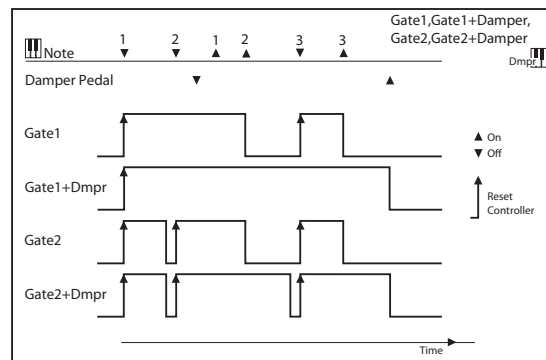

HD-1

The HD-1 supports all of the “Physical and MIDI controllers,” as described on page 903, in addition to the AMS sources below.

AMS Mixer1&2

These are the outputs of the oscillator’s AMS Mixers. For more information, see “6–1: OSC 1 AMS Mix” on page 89.

Wave Seq AMS Out1&2

These are the modulation outputs of the oscillator’s Wave Sequence. For more information, see “Modulating Program parameters per step” on page 187 of the OG.

Pitch EG

This is the output of the Pitch EG, which is shared between both oscillators. For more information, see “2–9: Pitch EG” on page 58.

Filter EG

This is the output of the oscillator’s Filter EG. For more information, see “3–4: Filter1 EG” on page 70.

Amp EG

This is the output of the oscillator’s Amp EG. For more information, see “4–3: Amp1 EG” on page 79.

LFO1 &2

These are the outputs of the oscillator’s two LFOs. For more information, see “5–1: OSC1 LFO1” on page 83.

Common LFO

This is the output of the Common LFO, which is shared by all voices of both oscillators. For more information, see “5–9: Common LFO” on page 87.

Filter Key Track

This is the output of the oscillator’s Filter Key Track generator. For more information, see “3–2: Filter1 Mod.” on page 65.

Amp Key Track

This is the output of the oscillator’s Amp Key Track generator. For more information, see “4–2: Amp1 Mod.” on page 76.

Common Key Track1&2

These are the outputs of the two Common Key Track generators, which are shared between both oscillators. For more information, see “6–9: Common KeyTrack” on page 96.

EXi Common

EXi programs support all of the “Physical and MIDI controllers,” as described on page 903, in addition to the AMS sources below, plus any AMS sources provided by the specific EXi instruments.

Common Step Seq

This is the output of the Common Step Sequencer, which is shared by all voices of both EXi. For more information, see “5–1: Common Step Seq” on page 136.

Common LFO

This is the output of the Common LFO, which is shared by all voices of both EXi. For more information, see “5–2: Common LFO” on page 139.

Common Key Track1&2

These are the outputs of the two Common Key Track generators, which are shared between both EXi. For more information, see “5–2: Common LFO” on page 139.

EXi AL-1

The AL-1 supports all of the “EXi Common” AMS sources, in addition to the AMS sources below.

AMS Mixer1&2

These are the outputs of the two AMS Mixers. For more information, see “6–1: OSC 1 AMS Mix” on page 89.

Step Sequencer

This is the output of the per-voice Step Sequencer. For more information, see “8–1: Step Sequencer” on page 173.

EG1 (Filter), EG2 (Pitch), and EGs 3 & 4

These are the outputs of the four assignable EGs. For more information, see “7–1: EG 1 (Filter)” on page 169.

Amp EG

This is the output of the dedicated Amp EG. For more information, see “6–3: Amp EG” on page 166.

LFO1 ...4

These are the outputs of the four assignable LFOs. For more information, see “8–2: LFO 1” on page 175.

Filter Key Track and Amp Key Track

These are the outputs of the Filter and Amp Key Track generators, respectively. For more information, see “5–3: Filter Mod.” on page 239 and “6–2: Amp Mod.” on page 243.

EXi CX-3

The CX-3 supports all of the “EXi Common” AMS sources, in addition to the AMS sources below.

AMS Mixer1&2

These are the outputs of the two AMS Mixers. For more information, see “6–1: OSC 1 AMS Mix” on page 89.

EXi STR-1

The STR-1 supports all of the “EXi Common” AMS sources, in addition to the AMS sources below.

AMS Mixer1...4

These are the outputs of the four AMS Mixers. For more information, see “6–1: OSC 1 AMS Mix” on page 89.

EG1 (Filter), EG2 (Pitch), and EGs 3 & 4

These are the outputs of the four assignable EGs. For more information, see “7–1: EG 1 (Filter)” on page 169.

Amp EG

This is the output of the dedicated Amp EG. For more information, see “6–3: Amp EG” on page 166.

LFO1 ...4

These are the outputs of the four assignable LFOs. For more information, see “8–2: LFO 1” on page 175.

Filter Key Track and Amp Key Track

These are the outputs of the Filter and Amp Key Track generators, respectively. For more information, see “5–3: Filter Mod.” on page 158 and “6–2: Amp Mod.” on page 164.

Damping String Track and Disp. String Track

These are the String Track generators for Damping and Dispersion, which can be used as AMS sources elsewhere in the STR-1. For more information, see “String Track” on page 225.

String Track1 & 2

These are the assignable String Track generators 1 and 2. For more information, see “9–9: String Track” on page 249.

Fret Position

The Fret Position is mostly used to shift the relationship between incoming notes and the String Track generators, but is also available as an AMS source. For more information, see “9–9a: Fret Position” on page 250)

Fret Number

This AMS source models the current position on the neck. For more information, see “Fret Number AMS Source” on page 250.

EXi MS-20EX

The MS-20EX supports all of the “EXi Common” AMS sources, in addition to the AMS sources below.

AMS Mixer1...4

These are the outputs of the four AMS Mixers. For more information, see “6–1: OSC 1 AMS Mix” on page 89.

EG3...6

These are the outputs of the four assignable EGs. For more information, see “7–1: EG 1 (Filter)” on page 169.

MG Tri and MG Pulse

The MS-20EX MG always generates both the triangle/sawtooth and pulse/square waveforms, simultaneously. For more information, see “5–1b: MODULATION GENERATOR (MG)” on page 263.

LFO1 ...4

These are the outputs of the four assignable LFOs. For more information, see “8–2: LFO 1” on page 175.

EXi PolysixEX

The PolysixEX supports all of the “EXi Common” AMS sources, in addition to the AMS sources below.

AMS Mixer1...4

These are the outputs of the four AMS Mixers. For more information, see “6–1: OSC 1 AMS Mix” on page 89.

Polysix EG

This is the output of the original Polysix ADSR envelope. For more information, see “4–1d: EG” on page 289.

EG2...3

These are the outputs of the two assignable EGs (in addition to the original Polysix EG). For more information, see “7–1: EG 1 (Filter)” on page 169.

MG and MG + Delay

These are the delayed and un-delayed outputs of the original Polysix MG. For more information, see “4–1b: MG (Modulation Generator)” on page 288.

LFO1 ...2

These are the outputs of the two assignable LFOs. For more information, see “8–2: LFO 1” on page 175.

EXi MOD-7

The MOD-7 supports all of the “EXi Common” AMS sources, in addition to the AMS sources below.

AMS Mixer1...8

These are the outputs of the eight AMS Mixers. For more information, see “PROGRAM > MOD-7: Seq, LFO, and AMS Mixers” on page 344.

EG1...9

These are the outputs of the nine assignable EGs. For more information, see “8–1: EG 1” on page 340.

Amp EG

This is the output of the dedicated Amp EG. For more information, see “7–5: Amp EG” on page 339.

LFO1 ...4

These are the outputs of the four assignable LFOs. For more information, see “8–2: LFO 1” on page 175.

Filter Key Track and Amp Key Track

These are the outputs of the Filter and Amp Key Track generators, respectively. For more information, see “5–3: Filter Mod.” on page 158 and “6–2: Amp Mod.” on page 164.

Step Sequencer

This is the output of the per-voice Step Sequencer. For more information, see “8–1: Step Sequencer” on page 173.

Alternate Modulation settings

When you operate an AMS (Alternate Modulation Source), the modulation destination will be affected as shown in the table below.

By using alternate modulation, you can create complex systems of modulation in which EG, LFO, keyboard tracks, and controllers work together.

- You can apply complex change to an LFO or EG, for example by using the pitch/filter/amp EG to control the frequency or intensity of an LFO that modulates the pitch/filter/amp, or by using LFO2 to control the frequency of LFO1.
- The tone, EG, and LFO etc. can be controlled not only by velocity or joystick, but also from a switch, knob, or pedal etc.
- Panning can be controlled in realtime from a controller, EG, or LFO etc.
- You can use the filter EG to control pitch or volume at the same time that it controls the filter.
- Controllers etc. can be used to control EG levels or times. This lets you shape the EG in realtime.
- Filter/amp keyboard tracking or note number can be used to control the EG or LFO according to the keyboard pitch that is played.
- Pitch, tone, EG or LFO can be controlled by the tempo of the Arpeggiator, DrumTrack/Step sequencer, or sequencer.

HD-1 AMS

| AMS source & value range | | | | | | | | | | EXT(+/-) *1 -Max... 0...+Max EXT (Tempo) *2 ♩=...60...120 ...240... | EXT(+) *3 0...127 |
|--------------------------|----------|-------------------|--|-------------------------------|---------------------------------|---|---|---|----------------------------------|--|-------------------------|
| Parameter | AMS Int. | Amp EG 0...+99 | Pitch & Filter EGs -99... 0...+99 | LFO1 & 2 -99... 0...+99 | Common LFO -99... 0...+99 | Filter & Amp Key Track -99... 0...+99 | Common Key Track 1 & 2 -99... 0...+99 | Wave Seq AMS Out 1 & 2 -99... 0...+99 | Note Number C-2... C4...C9 | | |
| Pitch | +12.00 | 0...+1 Octave | -1...0...+1 Octaves (Filter EG as AMS; dedicated parameter for Pitch EG) | dedicated parameter | -1...0...+1 Octaves | | | | dedicated parameter | -1...0...+1 Octaves | 0...+1 Octave |
| Pitch EG Int. | +12.00 | - | - | - | -1...0...+1 Octaves | | | - | -1...0...+1 Octaves | | 0...+1 Octave |
| Pitch LFO1/2 Int. | +12.00 | 0...+1 Octave | -1...0...+1 Octaves | - | -1...0...+1 Octaves | | | | | | 0...+1 Octave |
| Filter Frequency | +99 | 0...+10 Octaves | -10...0...+10 Octaves (Pitch EG as AMS; dedicated parameter for Filter EG) | dedicated parameters | | | | | -10...0...+10 Octaves | | 0...+10 Octaves |
| Filter Resonance | +99 | 0...+99 | -99...0...+99 | | | | | | | | 0...+99 |
| Filter EG Int. | +99 | - | - | - | -99...0...+99 | - | -99...0...+99 | - | - | -99...0...+99 | 0...+99 |
| Filter LFO1/2 Int. | +99 | 0...+99 | -99...0...+99 | - | -99...0...+99 | | | | | | 0...+99 |
| Filter Output Level A/B | +99 | 0...+99 | -99...0...+99 | | | | | | | | 0...+99 |
| Drive | | 0...+99 | -99...0...+99 | | | | | | | | 0...+99 |
| Low Boost | | 0...+99 | -99...0...+99 | | | | | | | | 0...+99 |
| Amp | +99 | - | 0...1x...8x | dedicated parameter | 0...1x...8x | dedicated parameter | - | 0...1x...8x | - | 0...1x...8x | 0...1x...8x |
| Amp LFO1/2 Int. | +99 | 0...+99 | -99...0...+99 | - | -99...0...+99 | | | | | | 0...+99 |
| Pan | +50 | 0...+63 | -63...0...+63 | | | | | | | | 0...+63 |
| EG Level | +66 | - | - | - | -99...0...+99 | | | - | -99...0...+99 | | 0...+99 |
| EG Time | +49 | - | - | - | 1/64x...1x...64x | | | - | 1/64x...1x...64x | | 1x...64x |
| LFO 1 Frequency *4 | +99 | 1x...64x | 1/64x...1x...64x | 1/64x...1x...64x (LFO2 only) | 1/64x...1x...64x | | | | | | 1x...64x |
| LFO 2 Frequency *4 | +99 | 1x...64x | 1/64x...1x...64x | - | 1/64x...1x...64x | | | | | | 1x...64x |
| Common LFO Frequency *4 | +99 | - | - | - | - | 1/64x...1x...64x | - | 1/64x...1x...64x | | 1x...64x | |
| Wave Sequence Start Step | +63 | - | - | - | -63...0...+63 | - | - | - | -63...0...+63 | | 0...+63 |

| | | | | | | | | | |
|-----------------------------|------|---------|------------------|---|---|---|---|------------------|---------|
| Wave Sequence Position | +63 | 0...+63 | -63...0...+63 | - | - | - | - | -63...0...+63 | 0...+63 |
| Wave Sequence Step Duration | 400% | 1x...4x | 1/100x...1x...4x | - | - | - | - | 1/100x...1x...4x | 1x...4x |

Notes for the table:

- *1 EXT(+/-): JS X, CC#16, CC#17, CC#19, Knob Mod.5 (CC#20), Knob Mod 6 (CC#21)
- *2 When Tempo is selected as an AMS source, the base value is ♩=120.00.
For example if the Pitch AMS is set to Tempo, and Intensity is set to +12.00, doubling the tempo value (♩=120.00 → 240.00) will raise the pitch one octave, and halving the tempo (♩=120.00 → 60.00) will lower the pitch one octave. The stated modulation results are for tempo values between 60bpm and 240bpm. As the tempo decreases from 60 to 0bpm, AMS modulation will have increasingly negative effects; as it increases from 240 to 250bpm, modulation will have increasingly positive effects.
- *3 EXT(+): Velocity, Exponential Velocity, Poly After Touch, After Touch, JS+Y (CC#01), JS-Y (CC#02), JS+Y & AT/2, JS-Y & AT/2, Foot Pedal (CC#04), CC#18[+], CC#17[+], CC#19[+], Knob Mod 5 [+], Knob mod.6 [+], Damper (CC#64), Porta.SW (CC#65), Sostenuito (CC#66), Soft (CC#67), SW1 Mod. (CC#80), SW2 Mod. (CC#81), Controller (CC#83), X-Y +X Mod. (CC#85), X-Y -X Mod. (CC#86), X-Y +Y Mod. (CC#87), X-Y -Y Mod. (CC#88).
- *4 It is possible to control LFO "Frequency" by using Tempo AMS and "Intensity." However if you use the Frequency MIDI/Tempo Sync function (PROGRAM 5-1c), the LFO frequency can be synchronized to the tempo and note value.

The effects of AMS on various parameters, and example applications

Using as HD-1 program as an example, we'll describe some examples of using alternate modulation.

Pitch (PROGRAM 2-2a)

Pitch can be controlled by the wave sequence's AMS Out, Common LFO, filter/amp EG, controllers, or tempo etc.

- If you select Filter EG or Amp EG as the AMS and set "Intensity" to +12.00, the pitch will change up to ±1 octave in synchronization with the EG.
- If you select Tempo as the AMS and set "Intensity" to +12.00, doubling the tempo (based on ♩=120bpms) will raise the pitch one octave, and halving the tempo will lower the pitch one octave.

Pitch EG Intensity (PROGRAM 2-2b)

Pitch EG intensity can be controlled by the wave sequence's AMS Out, Common LFO, keyboard tracking, controllers, or tempo.

- If you select JS +Y:CC#01 as the AMS and set "Intensity" to +12.00, moving the joystick in the +Y direction will gradually increase the effect of the Pitch EG to a maximum of ±1 octave. If "Intensity" has a negative value, the effect of the Pitch EG will be inverted.

Pitch LFO 1/2 Intensity (PROGRAM 2-2c)

Pitch modulation intensity of the LFO1/2 can be controlled by the wave sequence's AMS Out, Common LFO, an EG, keyboard tracking, controllers, or tempo etc.

- If you select EG as the AMS, the pitch change width of LFO modulation etc. can be controlled in synchronization with the level changes of the EG. With positive (+) settings of "Intensity," the vibrato effect will gradually deepen as the EG level rises, or gradually lessen as the EG level decreases. With negative (-) settings of "Intensity," the LFO phase will be inverted.
- If you select a controller such as SW1 or 2 as the AMS, you can press the SW1 or SW2 switch when desired to turn on the vibrato effect.

Filter (Cutoff) Frequency (PROGRAM 3-1b)

The cutoff frequency of filter A/B can be controlled by the wave sequence's AMS Out, pitch/amp EG, Common keyboard tracking, controllers, or tempo. Set AMS and "Intensity" for Filter A or B.

- If you select JS X as the AMS and set "Intensity" to a positive (+) value, moving the joystick toward the right will raise the cutoff frequency, and moving it toward the left will lower the cutoff frequency. Negative (-) settings will have the opposite effect.
- If you select the same controller as an AMS and set separate intensities for Filter A (Low Pass Filter) "Intensity" and Filter B (High Pass Filter) "Intensity," you can operate a single controller to simultaneously control the cutoff frequencies of both filters.

Resonance (PROGRAM 3-1b)

You can use the wave sequence's AMS Out, EG, LFO, keyboard tracking, controllers, or tempo etc. to control the resonance level.

- If you select Filter Key Track or Amp Key Track as the AMS, you can use the filter or amp keyboard tracking settings to control the resonance level. For example if the amp keyboard tracking parameters "Ramp Bottom-Low" and "Ramp High-Top" are set to positive (+) values, Amp Key Track is selected as the AMS, and "Intensity" it set to a positive (+) value, playing toward either end of the keyboard will cause amp keyboard tracking to increase the volume, and AMS to raise the resonance level.
- You can select a controller as the AMS, and apply resonance when desired by operating the controller.
- You can select Common LFO, LFO1 or 2 as the AMS, and use the LFO to control the resonance level.

Output Level (PROGRAM 3-1b)

You can use the wave sequence's AMS Out, EG, LFO, keyboard tracking, controllers, or tempo etc. to control the output level of Filter A/B.

- Set the Filter Routing to Parallel, and specify the desired Type and other settings for Filter A and Filter B. Set the

AMS to LFO for Filter A and Filter B, and set the LFO to +99 and -99 respectively. The output of Filter A and Filter B will be cyclically faded-in/out by the LFO.

Filter EG Intensity (PROGRAM 3-2b)

Filter EG intensity can be controlled by the Common LFO, Common keyboard tracking, a controller or tempo etc. You can use “Intensity to A” and “Intensity to B” to independently specify the intensity for Filter A and B.

- If you select JS -Y (CC#02) as the AMS and set “Intensity to A” and “Intensity to B” to a positive (+) value, moving the joystick in the -Y direction will gradually increase the effect of the Filter EG. If you set “Intensity to A” and “Intensity to B” to a negative (-) value, the effect of the Filter EG will be inverted.
- If you select CC#16 as the AMS and set “Intensity to A” and “Intensity to B” to a positive (+) value, operating the controller toward the right will gradually increase the effect of the Filter EG. Operating the controller toward the left will gradually increase the effect of the Filter EG with an inverted phase.

Filter LFO1/2 Intensity (PROGRAM 3-3a)

The LFO 1/2 filter modulation intensity can be controlled by the wave sequence’s AMS Out, EG, Common LFO, keyboard tracking, controller, or tempo etc. You can use **Intensity to A** and **Intensity to B** to independently specify the intensity for Filter A and B.

- If you select EG as the AMS, the auto-wah effect produced by LFO modulation will be controlled by the changes in EG level. If you set **Intensity to A** and **Intensity to B** to a positive (+) value, the wah effect will deepen as the EG level rises, and will lessen as the EG level falls. With negative (-) values of **Intensity to A** and **Intensity to B**, the phase of the LFO will be inverted.
- If you use a controller such as SW1 or 2 as the AMS, you can apply the auto-wah effect when desired by pressing the SW1 or SW2 switch.

Filter Common LFO1/2 (PROGRAM 3-3b)

You can use the wave sequence’s AMS Out, EG, LFO, keyboard tracking, controllers, or tempo etc. to control the Common LFO filter modulation intensity. You can use **Intensity to A** and **Intensity to B** to specify the intensity separately for Filter A and B.

- You can set AMS to a controller, and operate the controller only when desired to control the depth of the filter sweep produced by the Common LFO.

Driver Drive (PROGRAM 4-1a)

Driver Low Boost (PROGRAM 4-1a)

You can use the wave sequence’s AMS Out, EG, LFO, keyboard tracking, controllers, and tempo etc. to control the driver’s boost and low boost. Although you can use separate AMS to control these two parameters, it is also effective to control them simultaneously by using controllers such as the RT Control Knob. (It is particularly effective to control the filter resonance at the same time. This is also nice for synth bass sounds.)

- If you set AMS to Knob Mod.5, and set “Intensity” to a positive (+) value, turning RT Control Knob 5 toward the right will raise the drive and low boost level, and turning the knob toward the left will lower these parameters. If you set “Intensity” to a negative (-) value, the opposite result will occur.
- If you set AMS to Common LFO, LFO 1, or 2, the drive amount will be controlled cyclically by the LFO.

Amp (PROGRAM 4-2b)

The volume can be controlled by the wave sequence’s AMS Out, pitch/filter EG, Common LFO, controllers, or tempo etc.

- If an EG or controller that changes with a positive (+) value (EXT(+)) is selected as the AMS, setting the “Intensity” to +99 will allow you to increase the volume to a maximum of eight times that of the current volume.
- If an EG, LFO, or controller that changes with a ± value (Pitch EG, Filter EG, LFO, KT, EXT(+/-)) is selected as the AMS, setting the “Intensity” to +99 will allow you to increase the volume to a maximum of eight times that of the current volume (for positive (+) changes of the AMS), or to decrease the volume to zero (for negative (-) changes of the AMS).
- In addition to the time-variant changes in volume produced by the amp EG, you can also make the volume change in synchronization with the pitch/filter EG. Select Pitch EG or Filter EG as the AMS, and adjust “Intensity.” If you wish to cancel the effect of the Amp EG and use the pitch/filter EG to control the volume, set all levels of the Amp EG to +99.

Amp LFO1/2 Intensity (PROGRAM 4-2c)

The amp modulation intensity of LFO 1/2 can be controlled by the wave sequence’s AMS Out, EG, Common LFO, keyboard tracking, controllers, or tempo etc.

- If you select EG as the AMS, the depth of the tremolo effect produced by LFO modulation will change in synchronization with the changes in EG level. If you set “Intensity” to a positive (+) value, the tremolo effect will deepen as the EG level rises, and lessen as the EG level falls. If “Intensity” is set to a negative (-) value, the phase of the LFO will be inverted.
- If select a controller such as SW1 or 2 as the AMS, you can apply the tremolo effect by pressing the SW1 or SW2 switch when desired.

Pan (PROGRAM 4-1c)

The oscillator pan can be controlled by the wave sequence's AMS Out, EG, LFO, keyboard tracking, controllers, or tempo etc.

- If you select Note Number as the AMS and set "Intensity" to +50, panning will be controlled by the keyboard position: center at the C4 note, far right at C6 or above, and far left at C2 or below.
- If EG is selected as the AMS, the oscillator pan will be controlled in synchronization with the changes in EG level. If "Intensity" is set to a positive (+) value, the pan will move toward the right as the EG level increases, and toward the left as the EG level decreases. If "Intensity" is set to a negative (-) value, the opposite effect will occur.

EG Reset —

Pitch EG (PROGRAM 2-9a)

Filter EG (PROGRAM 3-4a)

Amp EG (PROGRAM 4-3a)

You can use the wave sequence's AMS Out, EG, LFO, keyboard tracking, controllers, or tempo etc. to control EG Reset. Use the Threshold setting to specify the AMS value at which result will occur.

- By setting AMS to Common LFO, you can reset the envelope cyclically at the interval of the Common LFO. The result is just as if the shape specified by the envelope were being used as a special LFO.
- You can reset the envelope by setting AMS to a controller such as JS+Y, and operating the controller when desired, producing a one-shot filter envelope sweep.

EG Level —

Pitch EG (PROGRAM 2-9c)

Filter EG (PROGRAM 3-4c)

Amp EG (PROGRAM 4-3c)

EG levels can be controlled by the wave sequence's AMS Out, Common LFO, keyboard tracking, controllers, or tempo etc.

You can specify an "Intensity" value for each EG segment ("Start," "Attack," "Break"). If you set the "Intensity" value to +66, you will be able to control the respective level over a maximum range of ±99.

- Set AMS to Velocity for Amp EG Level Modulation, Intensity "Start" to +00, "Attack" to +66, and "Break" to -66.
Set all Amp EG levels to +00. As you play with increasing velocity, the EG levels will change more greatly. At the maximum velocity, the Start Level will stay at +00, but the Attack Level will change to +99 and the Break Level will change to -99.

EG Time —

Pitch EG (PROGRAM 2-9d)

Filter EG (PROGRAM 3-4d)

Amp EG (PROGRAM 4-3d)

EG times can be controlled by the wave sequence's AMS Out, Common LFO, keyboard tracking, controllers, or tempo etc.

You can specify an "Intensity" value for each EG segment ("Attack," "Decay," "Slope," "Release"). EG times are determined by the Alternate Modulation value when the

preceding point is reached. For example, the Alternate Modulation value at the moment the envelope reaches the attack level will determine the decay time.

If "Intensity" is set to a value of 8, 17, 25, 33, 41, or 49, the corresponding time can be multiplied by a maximum of 2, 4, 8, 16, 32, or 64 times (or divided by 1/2, 1/4, 1/8, 1/16, 1/32, 1/64).

- Select JS +Y:CC#01 for "AMS," and set "AMS Intensity" to +8, "At" to +, "Dc" to -, and "Sl" and "Rl" to 0. When you move the joystick in the +Y direction, the Attack Time will be lengthened by a maximum of 2 times. The Decay Time will be shortened by a maximum of 1/2. The Slope and Release times will not change.

LFO Frequency (PROGRAM 5-1a)

The frequency of LFO 1, 2 or Common LFO can be controlled by the wave sequence's AMS Out, EG, keyboard tracking, controllers, or tempo etc.

You can also use the LFO2 frequency to modulate LFO1, or use the Common LFO frequency to modulate LFO 1/2.

If "Intensity" is set to a value of 16, 33, 49, 66, 82, or 99, the corresponding frequency can be multiplied by a maximum of 2, 4, 8, 16, 32, or 64 times (or divided by 1/2, 1/4, 1/8, 1/16, 1/32, 1/64).

- Select JS +Y:CC#01 for "AMS," and set "Intensity" to +16. When you move the joystick in the +Y direction, the LFO frequency will be increased by a maximum of 2 times. If you set "Intensity" to -16 and move the joystick in the +Y direction, the LFO frequency will be decreased by up to 1/2.

LFO Frequency AMS Intensity (PROGRAM 5-1b)

You can use the wave sequence's AMS out, EG, keyboard tracking, controllers, or tempo etc. to control the intensity of the AMS that controls the frequency of the LFO 1, 2, or Common LFO.

For example if you're using the pitch EG to modulate the LFO frequency, you could use a separate AMS to control the depth of this effect.

- Set AMS to a controller such as SW 1 or 2, so that the pitch EG will lightly control the LFO frequency when the switch is off, and more deeply when the switch is on.

LFO Shape (PROGRAM 5-1a)

You can use a wave sequence's AMS Out, EG, keyboard tracking, controllers, or tempo etc. to control the shape of the LFO 1, 2, or Common LFO waveform. You can also use the LFO2 frequency to modulate LFO1, or use the Common LFO frequency to modulate LFO 1/2.

- You can control the LFO waveform by setting AMS to a controller such as JS+Y, and operating the controller when desired.

Common LFO Reset (PROGRAM 5-9a)

You can use a controller or tempo etc. to reset the Common LFO.

- By setting AMS to Gate 1, you can make the Common LFO reset when a note is played from a state in which all notes are off. For example, this will ensure that a filter sweep always starts from the same place.
- You can set AMS to a controller such as JS+Y, and operate the controller when you want to reset the LFO.

Dynamic Modulation Sources (Dmod)

Overview

You can control certain effect parameters using the joystick, “on the fly.”

Controlling effects in this way is referred to as Dynamic Modulation. For example, you can push the joystick up to speed up the LFO of the chorus or flanger, to create a wah-wah sound and so on, maximizing the expressiveness of the effects as part of the instrument.

Most of the parameters for dynamic modulation consist of parameter values for **Source** and **Amount**. The **Source** field selects the modulation source, and **Amount** sets the modulation intensity. When the **Source** is at its maximum value (for instance, when JS+Y is moved all the way up), the actual degree of the effect will be the parameter value plus the **Amount**.

For example, let’s say that **Wet/Dry** = 10:90, **Source** = After Touch, and **Amount** = +50.

In this case, normally the effect balance is 10:90, but pushing the joystick up will progressively increase the ratio of the effect sound. The effect balance when the joystick is pushed up all the way is 60:40.

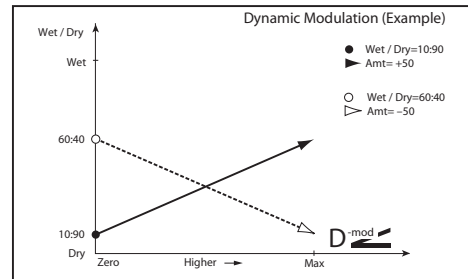

See the individual effects descriptions for explanations of other dynamic modulation parameters. Parameters which can be controlled through dynamic modulation are marked by the **D^{mod}** symbol.

Dmod and MIDI

MIDI In PROGRAM and SAMPLING modes, dynamic modulation is always controlled via the global MIDI Channel.

In COMBINATION and SEQUENCER modes, dynamic modulation is controlled via the MIDI channel independently specified by the “Ch” for IFX1–12, MFX1, 2, and TFX1, 2.

Dynamic Modulation Source List

| | |
|----------------------|---|
| Off | dynamic modulation is not used |
| Gate1 | note on/off →p.913 |
| Gate1+Damper | note on + damper on/off →p.913 |
| Gate2 | note on/off (retrigger) →p.913 |
| Gate2+Damper | note on + damper on/off (retrigger) →p.913 |
| Note Number | note number |
| Velocity | Velocity |
| Exponential Velocity | exponential velocity →p.913 |
| After Touch | after touch (Channel After Touch) |
| JS X | joystick X (horizontal) direction |
| JS+Y (CC#01) | joystick +Y (Vertical upward) direction (CC#01) |
| JS-Y (CC#02) | joystick -Y (Vertical downward) direction (CC#02) |
| Foot Pedal (CC#04) | assignable foot pedal (CC#04) →p.913 |
| FX Control1 (CC#12) | MIDI effect control 1 (CC#12) |
| FX Control2 (CC#13) | MIDI effect control 2 (CC#13) |
| (CC#18) | MIDI control change 18 (CC#18) →p.913 |
| (CC#17) | Control change 17 (CC#17) →p.913 |
| (CC#19) | Control change 19 (CC#19) →p.913 |

| | |
|---------------------|---|
| Knob Mod.5 (CC#20) | RT control knob 5 (knob modulation 5 CC#20) →p.913 |
| Knob Mod.6 (CC#21) | RT control knob 6 (knob modulation 6 CC#21) →p.913 |
| (CC#17) [+] | Control change 17 [+] →p.913 |
| (CC#19) [+] | Control change 19 [+] →p.913 |
| Knob Mod.5 [+] | RT control knob 5 [+] →p.913 |
| Knob Mod.6 [+] | RT control knob 6 [+] →p.913 |
| Damper (CC#64) | damper pedal (CC#64) |
| Porta. SW (CC#65) | portamento switch (CC#65) |
| Sostenuto (CC#66) | sostenuto pedal (CC#66) |
| Soft (CC#67) | soft pedal (CC#67) |
| SW1 Mod. (CC#80) | assignable panel switch 1 (SW1 modulation CC#80) →p.915 |
| SW2 Mod. (CC#81) | assignable panel switch 2 (SW2 modulation CC#81) →p.915 |
| Foot Switch (CC#82) | assignable foot switch (CC#82) →p.916 |
| Controller (CC#83) | MIDI Control Change (CC#83) |
| XY +X Mod.(CC#85) | X-Y Control +X (CC#85) →p.913 |
| XY -X Mod.(CC#86) | X-Y Control -X (CC#86) →p.913 |
| XY +Y Mod.(CC#87) | X-Y Control +Y (CC#87) →p.913 |
| XY -Y Mod.(CC#88) | X-Y Control -Y (CC#88) →p.913 |
| Tempo | tempo (internal clock or external MIDI clock tempo data) →p.913 |

Gate1, Gate1+Damper

The effect is at maximum during note-on, and will stop when all keys are released. With Gate1 + Damper, the effect will remain at maximum even after the keys are released, as long as the damper (sustain) pedal is pressed.

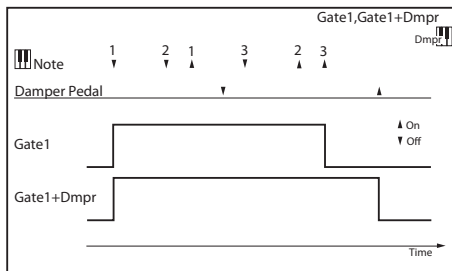

Gate2, Gate2+Damper

This is essentially the same as for Gate 1 or Gate 1 + Damper. However when Gate 2 or Gate 2 + Damper are used as a dynamic modulation source for the EG of 050: Stereo Envelope Flanger etc. or the AUTOFADE of 055: Stereo Vibrato, a trigger will occur at each note-on. (In the case of Gate 1 and Gate 1 + Damper, the trigger occurs only for the first note-on.)

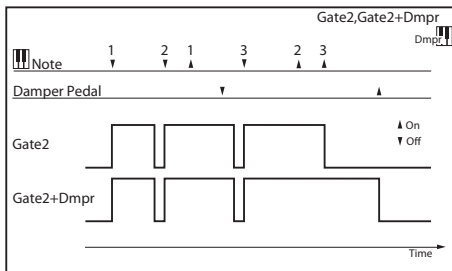

Exponential Velocity

Modulation will be applied exponentially according to the velocity value. Weak velocity values will produce little effect, but the effect will increase rapidly as the velocity values rise.

Foot Pedal (CC#04)

If you wish to use the assignable foot pedal as a dynamic modulation source, set “Foot Pedal Assign” (GLOBAL > Controllers/Scales 5-1a) to Foot Pedal (CC#04). (See “Foot Pedal Assignments” on page 919)

A foot controller etc. connected to the ASSIGNABLE PEDAL jack can be used to control an effect.

Knob Mod.5 (CC#20)

Knob Mod.6 (CC#21)

When the SELECT button on the front panel is set to “SOUND”, knob 5 (EFFECT) will output a CC#20 message.

Similarly, knob 6 (REVERB) will output a CC#21 message.

Knob Mod.5 [+] (CC#20 [+])

Knob Mod.6 [+] (CC#21 [+])

The knob’s position and the direction of its effect will differ from Knob Mod. 5 (CC#20)–Knob Mod.6 (CC#21).

When the “Amount” is a positive number, its effect as a dynamic modulation source when the knob is turned all the way to the left will be “0”. When the knob is turned to the

right, the effect will work in a positive direction only. (Negative values will make the effect work in the opposite direction.)

SW1 Mod. (CC#80)

SW2 Mod. (CC#81)

If you wish to use the SW1 or SW2 switch as a dynamic modulation source, make settings in PROGRAM, COMBINATION or SONG modes to set the Controllers: Switch page parameter “Panel Switch Assign” to the following values respectively: “SW1” to SW1 Mod. (CC#80), or “SW2” to SW2 Mod. (CC#81) (“SW1/2 Assignments” on page 915).

The effect will be controlled when you operate the SW1 or SW2 switch.

Foot Switch (CC#82)

If you wish to use an assignable foot switch as a dynamic modulation source, set “Foot Switch Assign” (GLOBAL 5–1a) to Foot SW (CC#82) (“Foot Switch Assignments” on page 917).

The effect will be controlled when you operate a foot switch etc. connected to the ASSIGNABLE SWITCH jack.

XY +X Mod. (CC#85)

XY –X Mod. (CC#86)

XY +Y Mod. (CC#87)

XY –Y Mod. (CC#88)

To use the X-Y control as a dynamic modulation source, set “+X”, “–X”, “+Y”, “–Y” of the “X-Y CC Control” on the X-Y Control page (or on the X-Y CC Page) for each Program, Combination or song respectively as follows: “XY+X Mod. (CC#85)”, “XY–X Mod. (CC#86)”, “XY+Y Mod. (CC#87)”, “XY–Y Mod. (CC#88)”. (When the “X/Y Mode” is set to positive or negative, the X-Y control can be used in either a positive or negative direction.)

Operate the X-Y control to apply modulation.

Note: Dynamic modulation using the X-Y control is disabled in SAMPLING mode.

Tempo

The resulting modulation will be zero at 120 BPM, the maximum positive value at 240 BPM, and the maximum negative value at 60 BPM.

Many effects LFOs and delays can also be synchronized to tempo. For more information, see “Tempo Synchronization” on page 734

MIDI/Tempo Sync function

The MIDI/Tempo Sync function can be used with most effects that have an LFO, such as “016: Stereo Wah/Auto Wah”, and with some delay-type effects such as “091: L/C/R BPM Delay”. The function can also be used with the Common FX LFO. You can use this to apply tempo-synchronized modulation. Also, if you specify the delay time in terms of a note value, the setting will follow any changes you make to the tempo of a wave sequence, X-Y envelope, step sequencer, drum track pattern or sequencer, which is useful such as when you’re playing live.

Parameters that feature a MIDI/Tempo Sync function are indicated by a  symbol on the right side of the parameter table for each effect.

Example 1: LFO

“MIDI/Tempo Sync” On

“Base Note” 1/4 “Times” x1

In this case, a single LFO cycle is set to the length of a single quarter note.

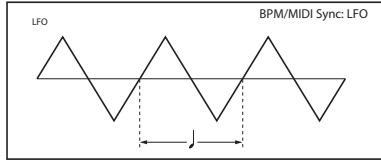

If “BPM” is set to “MIDI”, the LFO cycle will synchronize to the tempo of a wave sequence, X-Y envelope, step sequencer or sequencer (or to an external MIDI clock). If the “BPM” is within 40–240, the value specified here is used.

Example 2: Delay time

“L Delay Base Note” 1/8 “Times” x1

“R Delay Base Note” 1/16 “Times” x3

In this case, the left channel’s delay time is set to the length of a single eighth note, and the right channel’s delay time is set to the length of three sixteenth notes.

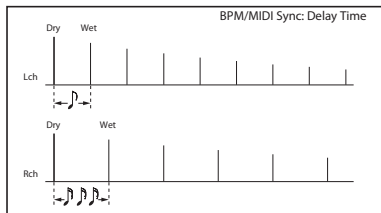

If “BPM” is set to “MIDI”, the LFO cycle will synchronize to the tempo of a wave sequence, X-Y envelope, step sequencer or sequencer (or to an external MIDI clock). If the “BPM” is within 40–300, the value specified here is used.

If the combined tempo, “Base Note” and “Times” causes the maximum delay time to be exceeded, “Time Over? > OVER!” will be displayed. Change the settings so that the message disappears. (The maximum delay time depends on the effect type.)

Controller Assignments

SW1/2 Assignments

Switch assignments are saved separately with each Program, Combination, and Song. In SAMPLING mode, assignments apply to the entire mode. For more information, see:

- PROGRAM > Basic/X-Y/Controllers– Controllers page
- COMBINATION > EQ/X-Y/Controllers– Controllers page
- SEQUENCER > EQ/X-Y/Controllers– Controllers page

List of SW 1/2 assignments

The following functions can be assigned to SW1 and SW2.

Off

This setting disables the switch.

SW1 Mod. (CC#80) and SW2 Mod. (CC#81)

This lets you use the switch as an AMS or Dmod source. Note that you'll also need to assign SW1 Mod or SW2 Mod to control the desired parameter within the Program or Effect.

Each time the switch is turned on or off, it transmits the corresponding MIDI CC (80 or 81); Off is 0, and On is 127.

Portamento SW (CC#65)

This turns Portamento on and off. When the LED is lit, Portamento is on.

Each time the switch is turned on or off, it transmits MIDI CC#65; Off is 0, and On is 127.

With single Programs, this simply enables and disables Portamento, regardless of the of the Program's stored **Portamento Enable** setting.

With double HD-1 or EXi Programs, it's slightly more complex. If Portamento is either enabled for both OSC 1 and 2 (or EXi 1 and 2), or off for both, then the Portamento Switch controls both OSC or EXi.

If Portamento is enabled for only one of the two, only that element will be affected by the switch; for the other element, Portamento will always be off.

Octave Down

When the switch is on (LED lit), the pitch will be transposed down by one octave.

Octave Up

When the switch is on (LED lit), the pitch will be transposed up by one octave.

Lock functions

The Lock functions let you use SW1 or SW2 to “lock” the current position of the joystick or ribbon controller, or the current aftertouch value. This leaves your hands free to play on the keyboard, or to use other controllers.

For instance, let's say that JS+Y is assigned to create a filter sweep, and that SW2 is assigned to JS+Y Lock. You can then:

1. Move the joystick to open up the filter.
2. Press SW2 to turn on JS+Y Lock.

3. Release the joystick.

Since SW2 is locking JS+Y, the filter remains open, even though the joystick has physically snapped back to its center position.

Note that Lock affects only the physical controls. Even if Lock is On, incoming MIDI messages can still change the joystick, ribbon, and aftertouch values.

For more information, see “Using the Lock function” on page 30 of the OG.

JS X Lock

Locks the effect of the joystick X axis.

JS Y Lock

Locks the effect of the joystick Y axis (both + and – directions).

JS+Y Lock

Locks the effect of the joystick +Y direction.

JS–Y Lock

Locks the effect of the joystick –Y direction.

Soft (CC#67)

This turns the Soft Pedal on and off.

Each time the switch is turned on or off, it transmits MIDI CC#67; Off is 0, and On is 127.

Most NAUTILUS sounds, including all SGX-2 **Piano Types**, include at least basic support for the Soft Pedal. For these sounds, when CC#67 is on, effective velocity is reduced—as if you were playing a little softer than you actually are.

As an alternative to this approach, some SGX-2 **Piano Types** include dedicated Una Corda samples. With these **Piano Types**, CC#67 switches to a different, dedicated set of samples instead of modifying velocity. For more information, see “5–1b: Una Corda” on page 354.

RT Control Knobs 1–6 Assignments

The RT control knobs 1–6 can be set to control the following functions when the SELECT button on the front panel is set to “USER”.

Configure these settings on the “Controller” page for each mode.

- PROGRAM > Basic/X-Y/Controllers– Controllers page
- COMBINATION > EQ/X-Y/Controllers– Controllers page
- SEQUENCER > EQ/X-Y/Controllers– Controllers page

Note: In PROGRAM, COMBINATION and SEQUENCER modes, configure the settings for each Program, Combination and song.

Knobs and MIDI CCs

Some of the assignments include MIDI CCs, which are transmitted whenever the knob is moved. Note that the MIDI CCs can still be received even if they are not assigned to a physical controller.

List of RT Control Knobs assignments

The following functions can be assigned to RT control knobs 1–6.

Off

This setting disables the knob.

Master Volume

This controls the volume of the main stereo outputs, after the Total Effects. It does not affect Individual Outputs 1–4.

This also transmits the Universal System Exclusive Master Volume message [F0H, 7FH, nn, 04, 01, vv, mm, F7H].

Portamento Time (CC#05)

This controls the portamento time. Note that a different controller, CC#65, turns Portamento on and off; see “Portamento SW (CC#65)” on page 915.

Volume (CC#07)

Controls the volume, and transmits CC#7.

Post IFX Pan (CC#08)

Controls the panning after the last Insert Effect in the chain, and transmits CC#8.

Pan (CC#10)

Controls stereo pan, and transmits CC#10.

Expression (CC#11)

Expression is a secondary volume control, which you can use to scale level without affecting the main volume settings or CC#7 values.

When used one at a time, MIDI Volume and Expression affect level in exactly the same way: a MIDI value of 127 is equal to Program’s main Level setting, and lower values reduce the volume.

If both CC#7 and CC#11 are used simultaneously, the one with the *lower* value determines the maximum volume, and the one with the *higher* value scales down from that maximum.

FX Control 1 & 2 (CC#s12 & 13)

These assignments are intended for Effect Dynamic Modulation (Dmod). Note that you’ll also need to assign **FX Control 1** or **2** to control the desired parameter within the Effect.

LFP Cutoff (CC#74)

This scales the cutoff frequency of all of the filters at once. For instance, in the HD-1, it affects both Filters A and B.

Resonance (CC#71)

This scales the resonance of all of the filters at once. For instance, in the HD-1, it affects both Filters A and B.

Filter EG Int. (CC#79)

This scales the effect of the Filter EG on the cutoff frequency. It affects all of the filters at once; for instance, in the HD-1, it affects both Filters A and B.

F/A Attack (CC#73)

This scales the attack times of the Filter and Amp EGs, along with other related parameters.

When the CC value is above 64, this also affects the Amp EG’s Start and Attack Levels, Start Level AMS, and Attack Time AMS, as described below:

Between values of 65 and 80, the Start Level, Start Level AMS, and Attack Time AMS will change from their programmed values to 0. Over the same range, the Attack Level will change from its programmed value to 99.

F/A Decay (CC#75)

This scales the decay and slope times of the Filter and Amp EGs.

F/A Sustain (CC#70)

This scales the sustain levels of the Filter and Amp EGs.

F/A Release (CC#72)

This scales the release times of the Filter and Amp EGs.

Pitch LFO1 Spd (CC#76)

This scales LFO1’s frequency.

Pitch LFO1 Dep (CC#77)

This scales the effect of LFO1 on the Pitch.

Pitch LFO1 Dly (CC#78)

This scales LFO1’s fade-in time.

SW 1 Mod. & SW 2 Mod (CC#s 80 & 81)

Normally, these are used for the two assignable switches - but you can assign them to the knobs instead, if you like.

Foot Switch (CC#82)

You can use this general-purpose controller as an AMS or Dmod source. Note that you’ll also need to assign **Foot Switch (CC#82)** to control the desired parameter within the Program or Effect.

MIDI CC#83 (CC#83)

You can use this general-purpose controller as an AMS or Dmod source. Note that you'll also need to assign **Controller #83** to control the desired parameter within the Program or Effect.

MFX Send 1 & 2 (CC#s 93 & 91)

These control the send levels to Master Effects 1 and 2, respectively.

CC#s 93 and 91 actually control send levels in two different places: the sends directly from the Program OSC or EXi, and the send levels of the last Insert Effect in the chain which matches the CC's MIDI channel.

MIDI CC#00–95 and 102–119

These settings let you transmit any MIDI CC, except for registered and non-registered parameters (CCs 96–101). If you choose a CC which is used by AMS, Dmod, or the standard CC routings, then it will affect the corresponding NAUTILUS parameters.

RT control knob functions when SOUND is selected

The functions of the RT control knobs 1–6 cannot be changed when the SELECT button on the front panel is set to "SOUND".

Knob1: LPF CUTOFF (Filter Cutoff: CC#74)

This scales the cutoff frequency of all of the filters at once. For instance, in the HD-1, it affects both Filters A and B.

Knob2: RESONANCE (Filter Resonance: CC#71)

This scales the resonance of all of the filters at once. For instance, in the HD-1, it affects both Filters A and B.

Knob3: EG INTENSITY (Filter EG Intensity: CC#79)

This scales the effect of the Filter EG on the cutoff frequency. It affects all of the filters at once; for instance, in the HD-1, it affects both Filters A and B.

Knob4: EG RELEASE (Filter, Amplifier EG Release: CC#72)

This scales the release times of the Filter and Amp EGs.

Knob5: EFFECT

Outputs a CC#20 message. For preloaded data, this knob adjusts how much the IFX effect is applied.

Knob6: REVERB

Outputs a CC#21 message. For preloaded data, this knob adjusts how much the reverb effect is applied.

Foot Switch Assignments

You can connect a footswitch (such as the optional Korg PS-1) to the rear-panel ASSIGNABLE SWITCH input, and then use it to control a wide variety of functions, as described below.

This setting is made globally, on the GLOBAL > Controllers/Scales– Controller "Foot Switch Assignment" (5–1a) page.

Foot Switch and MIDI CCs

Some of the assignments include MIDI CCs, which are transmitted each time the switch is turned on or off (Off = 0, and On = 127). Note that the MIDI CCs can still be received even if they are not assigned to a physical controller.

RT Knobs 1–6 and SW1/2 are special cases, since these can themselves be assigned to different MIDI CCs. If the foot switch is assigned to duplicate these controls, it will also use their CC assignments.

List of Foot Switch assignments

Off

This setting disables the switch.

Foot Switch (CC#82)

This lets you use the switch as an AMS or Dmod source. Note that you'll also need to assign Foot Switch (CC#82) to control the desired parameter within the Program or Effect.

Portamento SW (CC#65)

This controls portamento on/off. For more information, see "Portamento SW (CC#65)" on page 915.

Sostenuto (CC#66)

This controls the sostenuto effect, which holds only the notes being played at the moment that the footswitch is turned on.

Soft (CC#67)

Turns the soft pedal effect on and off.

Program Up

This lets you use the switch to increment the current Program, Combination, or Set List Slot number, for hands-free patch changes. Note that this is only active while on the PROGRAM > Home or COMBINATION > Home pages, respectively, or while in SET LIST mode.

When you use this control, the NAUTILUS will also transmit the corresponding MIDI Program Change and Bank Select messages.

Program Down

This decrements the current Program, Combination, or Set List Slot number, for hands-free patch changes. For more information, see "Program Up," above.

Song Start/Stop

The switch can be used to start/stop the sequencer. Simultaneously, a MIDI Start or Stop message will be transmitted.

Song Punch In/Out

If SEQUENCER > Preference "Recording Setup" is set to Manual Punch In, the switch will control recording punch-in and punch-out. (See "0–6a: Recording Setup" on page 456.)

Tap Tempo

This duplicates the function of the front-panel TAP button, for setting the system tempo in real-time.

ARP ON/OFF

The foot switch will turn ARP on/off.

ARP LATCH ON/OFF

The foot switch will turn ARP LATCH on/off.

JS+Y (CC#01)

The switch will control the effect produced by joystick movement in the +Y direction (Vertical upward).

JS-Y (CC#02)

The switch will control the effect produced by joystick movement in the -Y direction (Vertical downward).

CC#16, CC#18

The switch will control the effect of the VALUE slider.

RT Knob1...6

The switch duplicates the function of the selected RT Control Knobs 1-6. When the switch is on, it produces the same effect as when the knob is rotated fully to the right; when it is Off, it produces the same effect as when the knob is rotated fully to the left.

SW1, 2

The footswitch duplicates the function of the selected front-panel switch.

Value Inc

The switch will duplicate the function of the front-panel + button. For more information, see “Using a footswitch to select Programs” on page 28 of the OG.

Value Dec

The switch will duplicate the function of the front-panel - button.

DRUM ON/OFF

The foot switch will turn the Drum Track on and off, duplicating the functionality of the front-panel DRUM TRACK button.

Foot Pedal Assignments

You can connect a pedal (such as the optional Korg XVP-20 or EXP-2) to the rear-panel ASSIGNABLE PEDAL input, and then use it to control a wide variety of functions, as described below.

This setting is made for the entire NAUTILUS, on the GLOBAL > Controllers/Scales– Controller “Foot Pedal Assignment” (5–1a) page.

A note on MIDI CCs

Some of the assignments include MIDI CCs, which are transmitted whenever the knob is moved. Note that the MIDI CCs can still be received even if they are not assigned to a physical controller.

RT Control Knobs 1–6 and SW1/2 are special cases, since these can themselves be assigned to different MIDI CCs. If the footswitch is assigned to duplicate these controls, it will also use their CC assignments.

List of Foot Pedal assignments

Off

This setting disables the pedal.

Master Volume

This controls the volume of the main stereo outputs, after the Total Effects. It does not affect Individual Outputs 1–4.

This also transmits the Universal System Exclusive Master Volume message [F0H, 7FH, nn, 04, 01, vv, mm, F7H].

Foot Pedal (CC#04)

You can use this general-purpose controller as an AMS or Dmod source. Note that you’ll also need to assign **Foot Pedal (CC#04)** to control the desired parameter within the Program or Effect.

Portamento Time (CC#05)

Controls the speed at which portamento will change the pitch.

Volume (CC#07)

Control the volume of a Program, Combination, or of a MIDI track in SEQUENCER modes.

Post IFX Pan (CC#08)

Control the pan after passing through the Insert Effect.

Pan (CC#10)

Control the pan of a Program, of a timbre in a Combination, or of a MIDI track in SEQUENCER modes.

Expression (CC#11)

Expression is a secondary volume control, which you can use to scale level without affecting the main volume settings or CC#7 values. For more information, see “Expression (CC#11)” on page 916.

FX Control 1 & 2 (CC#s12 & 13)

These assignments are intended for Effect Dynamic Modulation (Dmod). Note that you’ll also need to assign **FX Control 1** or **2** to control the desired parameter within the Effect.

MFX Send 1 & 2 (CC#s 93 & 91)

These control the send levels to Master Effects 1 and 2, respectively.

CC#s 93 and 91 actually control send levels in two different places: the sends directly from the Program OSC or EXi, and the send levels of the last Insert Effect in the chain which matches the CC’s MIDI channel.

JS+Y (CC#01)

This duplicates the function of JS+Y. Whatever JS+Y is assigned to control, the pedal will control as well.

JS–Y (CC#02)

This duplicates the function of JS–Y. Whatever JS–Y is assigned to control, the pedal will control as well.

CC#16, CC#18

The pedal is used to control the effect of parameters to which CC#16 and CC#18 are assigned.

RT Knob1...6

This duplicates the function of the selected RT Control Knobs 1–6. Whatever the knob is assigned to control, the pedal will control as well.

MIDI transmission from NAUTILUS controllers

MIDI Messages and physical controllers

| CC# | MIDI messages | Joystick | X-Y Control | X-Y CC Control | RT Control Knob 1...6 | SW1, 2 | ARP On/Off | LATCH On/Off | DRUM On/Off | Damper | Foot Switch | Foot Pedal | Available for AMS | Available for Dmod |
|-------------|---------------------------|----------|-------------|----------------|-----------------------|--------|------------|--------------|-------------|--------|-------------|------------|-------------------|--------------------|
| | Note-off (velocity) | | | | | | | | | | | | *(1) | |
| | Note-on (note number) | | | | | | | | | | | | * | * |
| | Note-on (velocity) | | | | | | | | | | | | * | * |
| | Poly after touch | | | | | | | | | | | | * | |
| 0 | Bank select (MSB) | | * | * | * | | * | * | * | | | | | |
| 1 | Modulation 1 | #+(Y) | * | * | * | | * | * | * | | * | * | * | * |
| 2 | Modulation 2 | #(-Y) | * | * | * | | * | * | * | | * | * | * | * |
| 3 | - | | * | * | * | | * | * | * | | | | | |
| 4 | Foot controller | | * | * | * | | * | * | * | | | * | * | * |
| 5 | Portamento time | | * | * | * | | * | * | * | | | * | | |
| 6 | Data entry (MSB) | | * | * | * | | * | * | * | | | | | |
| 7 | Volume | | * | * | * | | * | * | * | | | * | | |
| 8 | Post Insert Effect panpot | | * | * | * | | * | * | * | | | * | | |
| 9 | - | | * | * | * | | * | * | * | | | | | |
| 10 | Panpot | | * | * | * | | * | * | * | | | * | | |
| 11 | Expression | | * | * | * | | * | * | * | | | * | | |
| 12 | Effect control 1 | | * | * | * | | * | * | * | | | * | | * |
| 13 | Effect control 2 | | * | * | * | | * | * | * | | | * | | * |
| 14 | ARP On/Off button | | * | * | * | | * | * | * | | * | | | |
| 15 | DRUM On/Off button | | * | * | * | | * | * | * | | | | | |
| 16 | Controller (CC#16) | | * | * | * | | * | * | * | | * | * | * | * |
| 17 | Controller (CC#17) | | * | * | * | | * | * | * | | * | * | * | * |
| 18 | Controller (CC#18) | | * | * | * | | * | * | * | | * | * | * | * |
| 19 | Controller (CC#19) | | * | * | * | | * | * | * | | * | * | * | * |
| 20 | Knob modulation 5 | | * | * | *(Knob5) | | * | * | * | | | * | * | * |
| 21 | Knob modulation 6 | | * | * | *(Knob6) | | * | * | * | | | * | * | * |
| 22... 30 | - | | * | * | * | | * | * | * | | | | | |
| 31 | LATCH On/Off Button | | * | * | * | | * | * | * | | | | | |
| 32 | Bank select (LSB) | | * | * | * | | * | * | * | | | | | |
| 33... 37 | - | | * | * | * | | * | * | * | | | | | |
| 38 | Data entry (LSB) | | * | * | * | | * | * | * | | | | | |
| 39... 63 | - | | * | * | * | | * | * | * | | | | | |
| 64 | Damper | | * | * | * | | * | * | * | # | | | * | * |
| 65 | Portamento On/Off | | * | * | * | * | * | * | * | | * | | * | * |
| 66 | Sostenuto On/Off | | * | * | * | | * | * | * | | * | | * | * |
| 67 | Soft pedal | | * | * | * | | * | * | * | | * | | * | * |
| 68... 69 | - | | * | * | * | * | * | * | * | | | | | |
| 70 | Sustain level | | * | * | * | | * | * | * | | | | | |
| 71 | Filter resonance level | | * | * | *(Knob2) | | * | * | * | | * | * | | |
| 72 | Release time | | * | * | *(Knob4) | | * | * | * | | * | * | | |
| 73 | Attack time | | * | * | * | | * | * | * | | | | | |
| 74 | Filter cutoff frequency | | * | * | *(Knob1) | | * | * | * | | * | * | | |
| 75 | Decay time | | * | * | * | | * | * | * | | | | | |
| 76 | LFO1 speed | | * | * | * | | * | * | * | | | | | |
| 77 | LFO1 depth (pitch) | | * | * | * | | * | * | * | | | | | |
| 78 | LFO1 delay | | * | * | * | | * | * | * | | | | | |
| 79 | Filter EG intensity | | * | * | *(Knob3) | | * | * | * | | * | * | | |
| 80 | SW1 modulation On/Off | | * | * | * | *(SW1) | * | * | * | | | | * | * |
| 81 | SW2 modulation On/Off | | * | * | * | *(SW2) | * | * | * | | | | * | * |

MIDI transmission from NAUTILUS controllers Foot Pedal Assignments

| CC# | MIDI messages | Joystick | X-Y Control | X-Y CC Control | RT Control Knob 1...6 | SW1, 2 | ARP On/Off | LATCH On/Off | DRUM On/Off | Damper | Foot Switch | Foot Pedal | Available for AMS | Available for Dmod |
|---------------------|--|----------|-------------|----------------|-----------------------|--------|------------|--------------|-------------|--------|-------------|------------|-------------------|--------------------|
| 82 | Foot switch On/Off | | * | * | * | | * | * | * | | * | | * | * |
| 83 | Controller (CC#83) | | * | * | * | | * | * | * | | | | * | * |
| 84 | - | | * | * | * | | * | * | * | | | | | |
| 85 | X-Y Control modulation +X | | * | * | * | | * | * | * | | | | * | * |
| 86 | X-Y Control modulation -X | | * | * | * | | * | * | * | | | | * | * |
| 87 | X-Y Control modulation +Y | | * | * | * | | * | * | * | | | | * | * |
| 88 | X-Y Control modulation -Y | | * | * | * | | * | * | * | | | | * | * |
| 89... | - | | * | * | * | | * | * | * | | | | | |
| 90 | - | | * | * | * | | * | * | * | | | | | |
| 91 | Effect depth 1 (send 2 level) | | * | * | * | | * | * | * | | * | | | |
| 92 | Effect depth 2 (Insert Effect 1-12 On/Off) | | * | * | * | | * | * | * | | | | | |
| 93 | Effect depth 3 (send 1 level) | | * | * | * | | * | * | * | | * | | | |
| 94 | Effect depth 4 (master effect 1, 2 On/Off) | | * | * | * | | * | * | * | | | | | |
| 95 | Effect depth 5 (total effect 1, 2 On/Off) | | * | * | * | | * | * | * | | | | | |
| 96 | Data increment | | * | * | * | | * | * | * | | | | | |
| 97 | Data decrement | | * | * | * | | * | * | * | | | | | |
| 98 | NRPN(LSB) | | * | * | * | | * | * | * | | | | | |
| 99 | NRPN(MSB) | | * | * | * | | * | * | * | | | | | |
| 100 | RPN(LSB) | | * | * | * | | * | * | * | | | | | |
| | 0: Bend range | | * | * | * | | * | * | * | | | | | |
| | 1: Fine tune | | * | * | * | | * | * | * | | | | | |
| | 2: Coarse tune | | * | * | * | | * | * | * | | | | | |
| 101 | RPN(MSB) 0 | | * | * | * | | * | * | * | | | | | |
| 102... | - | | * | * | * | | * | * | * | | | | | |
| 117 | - | | * | * | * | | * | * | * | | | | | |
| 118 | X-Y Control X | | [*] (X) | * | * | | * | * | * | | | | | |
| 119 | X-Y Control Y | | [*] (Y) | * | * | | * | * | * | | | | | |
| | Program change | | | | | | | | | | | | | |
| | Channel after touch | | | | | | | | | | | | * | * |
| | Bender change | # (X) | | | | | | | | | | | * | * |
| Universal exclusive | | | | | | | | | | | | | | |
| | Master volume | | | | * | | | | | | * | | | |
| | Master balance | | | | | | | | | | | | | |
| | Master fine tune | | | | | | | | | | | | | |
| | Master coarse tune | | | | | | | | | | | | | |

(1): EP-1 only

#: Fixed *: Assignable

[*]: The X-Y Control can be assigned to CC#00-119. CC#s indicated by [*] will be assigned automatically when you execute the GLOBAL > Controllers/Scales- Controllers page menu command "Reset Controller MIDI Assign" with the CC Default setting.

The CC Default settings are the CC#s recommended as the CC# for each of these controllers. Normally you should use these settings when assigning CC#s.

Fixed assignments

The following physical controls have fixed assignments to MIDI CCs:

| | |
|-------------------|---------------------------------|
| Joystick +Y | Modulation 1 (CC#1) |
| Joystick -Y | Modulation 2 (CC#2) |
| Joystick X | Pitch Bend |
| RT Control Knob 1 | Filter cutoff frequency (CC#74) |
| RT Control Knob 2 | Filter resonance (CC#71) |
| RT Control Knob 3 | Filter EG intensity (CC#79) |
| RT Control Knob 4 | Release time (CC#72) |
| SW1 | SW1 modulation On/Off (CC#80) |
| SW2 | SW2 modulation On/Off (CC#81) |
| Damper pedal | Damper (CC#64) |

PROGRAM mode

When one of the NAUTILUS's controllers is operated, a control change message will be transmitted on the global MIDI channel (**MIDI Channel GLOBAL 1-1a**).

- 🔊 If one of the RT Control Knobs 1-6 or the assignable pedal has been set to **Master Volume**, the universal system exclusive message Master Volume will be transmitted.

COMBINATION mode

When one of the NAUTILUS's controllers is operated, a control change message will be transmitted on the global MIDI channel (**MIDI Channel GLOBAL 1-1a**).

Simultaneously, the message will also be transmitted on the MIDI channel (**MIDI Channel COMBINATION 2-1a**) of any timbre whose **Status** (COMBINATION 0-1b, 2-1a) is EXT or EX2.

When one of the NAUTILUS's controllers is operated, its effect will apply to any timbre whose **Status** is INT and whose **MIDI Channel** setting is either Gch or the same as the global MIDI channel.

- 🔊 In the case of Master Volume, the universal exclusive message Master Volume will be transmitted only on the global MIDI channel.
- 🔊 You can make settings for MIDI Filter (COMBINATION > MIDI Filter/Zones- MIDI Filter1(-3)) to enable or disable control changes and controllers for each timbre. When checked, the above operations will be enabled.

Effect dynamic modulation can be controlled when the **Ch** (Channel) setting for IFX1-12, MFX1, 2, or TFX 1, 2 is either set to Gch or to the same channel as the global MIDI channel. (In the case of All Routed, control is possible on the MIDI channel of any routed timbre.)

SEQUENCER mode

When one of the NAUTILUS's controllers is operated, its effect will apply to the MIDI track 1-16 that is selected by **Track Select** (SEQUENCER 0-1a).

If the **Status** (SEQUENCER 2-1a) of the track selected by **Track Select** is EXT, EX2, or Both, a control change message will be transmitted on the MIDI channel specified by **MIDI Channel** (SEQUENCER 2-1a).

If the **Status** is INT or Both, operating one of the NAUTILUS's controllers will affect only that MIDI track. Simultaneously, the same effect will also apply to any MIDI track with the same **MIDI Channel** setting.

- 🔊 In the case of Master Volume, the universal exclusive message Master Volume will be transmitted.
- 🔊 You can make settings for MIDI Filter (SEQUENCER > MIDI Filter/Zones- MIDI Filter1(-3)) to enable or disable control changes and controllers for each track. When checked, the operations effective for a **Status** of INT or Both will be enabled. Tracks whose **Status** is EXT, EX2, or Both will transmit control changes regardless of this setting.

Effect dynamic modulation can be controlled when the **Ch** (SEQUENCER 8-7a, 9-2a, 9-3, 9-4) setting for IFX1-12, MFX1, 2, or TFX1, 2 matches the MIDI channel of the track selected by **Track Select**. (In the case of All Routed, control is possible on the MIDI channel of all routed tracks.)

If one of the NAUTILUS's controllers is operated during realtime recording, the corresponding or assigned control change will be recorded.

SAMPLING mode

When one of the NAUTILUS's controllers is operated, a control change message will be transmitted on the global MIDI channel (**MIDI Channel GLOBAL 1-1a**).

- 🔊 In the case of Master Volume, the universal exclusive message Master Volume will be transmitted.
- 🔊 It is not possible to make AMS settings in SAMPLING mode.

NAUTILUS and MIDI CCs

Responses to standard MIDI controllers

The following table shows the relationships between MIDI CCs, physical controls on the NAUTILUS, and synthesis and effects parameters.

| CC# | Name | Range | Notes |
|---------|-------------------------|---------------------------|--|
| 0 | Bank select (MSB) | 0...127 | Bank Select message MSB *1 |
| 1 | Modulation 1 | 0...127 | Joystick +Y (forwards, away from the player) |
| 2 | Modulation 2 | 0...127 | Joystick -Y (backwards, towards the player) |
| 3 | - | - | - |
| 4 | Foot Controller | 0...127 | AMS/Dmod source Foot Pedal.; may be assigned to the Assignable Pedal |
| 5 | Portamento time | 0...127 | Portamento time |
| 6 | Data entry (MSB) | 0...127 | MSB of RPN and NRPN data *2 |
| 7 | Volume | 0...127 | Main volume *3 |
| 8 | Post Insert Effect pan | 0...127 | Pan after the Insert Effect (Post-IFX Pan) |
| 9 | - | - | - |
| 10 | Panpot | 0...127 | Pan |
| 11 | Expression | 0...127 | Scales main volume *3 |
| 12 | Effect Control 1 | 0...127 | AMS/Dmod source FX Control1 |
| 13 | Effect Control 2 | 0...127 | AMS/Dmod source FX Control2 |
| 14 | ARP ON/OFF | 0...63(Off), 64...127(On) | Corresponds to on/off when CC#14 is assigned to the ARP button *6 |
| 15 | DRUM ON/OFF Control | 0...63(Off), 64...127(On) | Corresponds to on/off when CC#15 is assigned to the DRUM button *6 |
| 16 | Controller (CC#16) | 0...127 | For AMS, DMOD control |
| 17 | Controller (CC#17) | 0...127 | For AMS, DMOD control |
| 18 | Controller (CC#18) | 0...127 | For Alternate Modulation, Effect Dynamic Modulation control |
| 19 | Controller (CC#19) | 0...127 | For AMS, DMOD control |
| 20 | Knob Modulation 5 | 0...127 | AMS/Dmod source Knob Mod.5; may be assigned to RT control knobs 1...6 |
| 21 | Knob Modulation 6 | 0...127 | AMS/Dmod source Knob Mod.6; may be assigned to RT control knobs 1...6 |
| 32 | Bank select (LSB) | 0...127 | Bank Select message LSB *1 |
| 33...37 | - | - | - |
| 38 | Data entry (LSB) | 0...127 | LSB of RPN or NRPN data *2 |
| 39...63 | - | - | - |
| 64 | Damper | 0...127 | Damper (sustain pedal) |
| 65 | Portamento On/Off | 0...63(Off), 64...127(On) | Turns portamento (glide) on/off |
| 66 | Sostenuto | 0...63(Off), 64...127(On) | Sostenuto (holds only the notes sounding at the time that the footswitch is turned on) |
| 67 | Soft | 0...127 | Soft pedal (reduces effective velocity) |
| 68...69 | - | - | - |
| 70 | Sustain level | 0...127 | Scales Sustain levels of the filter and amp EGs *4 |
| 71 | Filter resonance level | 0...127 | Scales filter resonance amount *4 |
| 72 | Release time | 0...127 | Scales Release times of the filter and amp EGs *4 |
| 73 | Attack time | 0...127 | Scales Attack times of the filter and amp EGs *4 |
| 74 | Filter cutoff frequency | 0...127 | Scales filter cutoff frequency (usually controls brightness) *4 |

| CC# | Name | Range | Notes |
|---------|---------------------|---------------------------|--|
| 75 | Decay time | 0...127 | Scales Decay and Slope times of the filter and amp EGs *4 |
| 76 | LFO1 speed | 0...127 | Scales LFO1 speed *4 |
| 77 | LFO1 depth | 0...127 | Scales amount of pitch modulation by LFO1 *4 |
| 78 | LFO1 delay | 0...127 | Scales LFO1 delay *4 |
| 79 | Filter EG intensity | 0...127 | Scales amount of cutoff modulation by filter EG *4 |
| 80 | SW1 modulation | 0...63(Off), 64...127(On) | AMS/Dmod source SW1 Mod.; may be assigned to physical SW1 |
| 81 | SW2 modulation | 0...63(Off), 64...127(On) | AMS/Dmod source SW2 Mod.; may be assigned to physical SW2 |
| 82 | Foot switch | 0...63(Off), 64...127(On) | AMS/Dmod source Foot Switch; may be assigned to the Assignable Foot Switch |
| 83 | Controller (CC#83) | 0...127 | AMS/Dmod source |
| 84 | – | – | – |
| 85 | X-Y Control +X | 0...127 | X-Y Control position on the X axis (XY +X Mod.) |
| 86 | X-Y Control –X | 0...127 | Inverse of X-Y Control position on the X axis (XY –X Mod.) |
| 87 | X-Y Control +Y | 0...127 | X-Y Control position on the Y axis (XY +Y Mod.) |
| 88 | X-Y Control –Y | 0...127 | Inverse of X-Y Control position on the Y axis (XY –Y Mod.) |
| 89...90 | – | – | – |
| 91 | Effect depth 1 | 0...127 | Scales Send 2 level |
| 92 | Effect depth 2 | 0...63(Off), 64...127(On) | Simultaneous on/off control for Insert Effects 1...12 *5 |
| 93 | Effect depth 3 | 0...127 | Scales Send 1 level |
| 94 | Effect depth 4 | 0...63(Off), 64...127(On) | Simultaneous on/off control for Master Effects 1&2 *5 |
| 95 | Effect depth 5 | 0...63(Off), 64...127(On) | Simultaneous on/off control for Total Effects 1&2 *5 |
| 96 | Data increment | 0 | |
| 97 | Data decrement | 0 | |
| 98 | NRPN(LSB) | – | LSB of NRPN |
| 99 | NRPN(MSB) | – | MSB of NRPN |
| 100 | RPN(LSB) | 0 | Selects Pitch Bend Range for RPN editing *2 |
| | | 1 | Selects Fine Tune for RPN editing *2 |
| | | 2 | Selects Coarse Tune for RPN editing *2 |
| 101 | RPN(MSB) | 0 | MSB of RPN |
| 118 | X-Y Control X | 0...127 | Default CC assignment for X-Y Control X-axis *7 |
| 119 | X-Y Control Y | 0...127 | Default CC assignment for X-Y Control Y-axis *7 |

***1 Bank Select**

In the NAUTILUS sequencer, bank select messages are normally specified as part of program change events. In some cases, however, this may be insufficient when changing banks on an external device. In such cases, you can use CC#00 and CC#32 to specify the banks.

For information on the relation between bank select numbers and the banks of your external device, refer to the owner’s manual for your external device.

***2 RPN (Registered Parameter Number)**

Pitch bend range, fine tune, and coarse tune can be controlled using Registered Parameter Control (RPC) messages. As with standard CCs, these apply individually to each MIDI channel.

RPCs work differently from standard CCs. First, you send a Registered Parameter Number (RPN) message to select the parameter that you wish to edit. This message includes two

CCs: first CC#100 with a value of 1, 2, or 3 (to select the parameter) and then CC#101 with a value of 0 (to complete the message).

Next, you set the value for the selected parameter using CC#06. In the case of RPN 1 (Fine Tune), you can also use CC#38 for extra-fine control.

The data entry values for each parameter and the corresponding settings are as follows.

RPN CC#100=0 (Pitch Bend Range)

| CC#06 | Bend range, Semitones |
|-------|-----------------------|
| 00 | 0 |
| 01 | +1 |
| ... | ... |
| 12 | +12 |

RPN CC#100=1 (Fine Tune)

| CC#06 | CC#38 | Tuning, 1 cent steps |
|-------|-------|----------------------|
| 32 | 00 | -50 |
| ... | ... | ... |
| 48 | 00 | -25 |
| ... | ... | ... |
| 64 | 00 | 0 |
| 64 | 127 | ~+1.5 |
| ... | ... | ... |
| 96 | 00 | +50 |

RPN CC#100=2 (Coarse Tune)

| CC#06 | Tuning, semitones |
|-------|-------------------|
| 40 | -24 |
| ... | ... |
| 52 | -12 |
| ... | ... |
| 64 | 0 |
| ... | ... |
| 88 | +24 |

For example, if in SEQUENCER mode you wish to set a MIDI track on channel 1 to a transpose (coarse tuning) value of -12, you would first transmit [B0, 64, 02] (64H=CC#100) and [B0, 65, 00] (65H=CC#101) to the NAUTILUS to select the RPN coarse tune. Then you would set this to -12 by transmitting [B0, 06, 34] (06H=CC#6), 34H=52 (corresponds to -12), and [B0, 26, 00] (26H=CC#38, 00H=0).

***3 Volume and Expression**

The volume of the NAUTILUS is determined by multiplying Volume (CC#07) with Expression (CC#11). In SEQUENCER mode when you stop the song playback and return the location to the beginning of the track, the Volume will be set to the starting value, and the Expression will be set to the maximum value (127).

***4 CCs 70...79**

A value of 64 will correspond to the value specified by the program parameter. 0 is the minimum, and 127 is the maximum. Changing from 63-1 or from 65-126 will adjust the effect from the program parameter setting toward the minimum value or maximum value.

For details about the specific parameters controlled by these CCs, please see "Parameters controlled by MIDI CCs #70-79" on page 926.

***5 Effect Depths 2, 4, and 5**

These CCs are recognized only on the global MIDI channel.

***6 RT control knob**

When you set a CC# for an RT control knob (when selecting ARP/DRUM with the SELECT button) or for a button and then operate these controls on the NAUTILUS, the CC# that was set is transmitted and the NAUTILUS will be controlled at the same time. When the message is received, a similar effect to the one that is applied when operating the NAUTILUS will be applied.

Set the CC# for each RT control knob and button from the GLOBAL > Controllers/Scales- Controller page. Normally, this is set to "Off". Set and use this when you need to assign MIDI control change messages, such as when you want to record your use of the RT control knobs to the internal sequencer or to an external MIDI sequencer, or when you want to control the arpeggiator function from an external MIDI sequencer.

Although you can assign MIDI control change messages from CC#00 to 119 to each RT control knob and button, normally you select the "Reset Controller MIDI Assign" page menu command in GLOBAL > Controllers/Scale and then use the "CC Default" settings.

This table shows how the operation works when using the "CC Default" setting.

The "CC Default" setting is the recommended CC# for using these controllers. Normally, you will assign this CC# for use.

***7 X-Y Control and MIDI CCs**

By default, the X-Y Control X-axis and Y-axis are assigned to CCs 118 and 119, as shown in the table above. These can be changed if desired.

The Global MIDI **X-Y MIDI Out** parameter also affects MIDI transmission from the X-Y Control and X-Y Envelope. For more information, see "Vector and MIDI" on page 41 and "X-Y MIDI Out" on page 653.

Parameters controlled by MIDI CCs #70-79

MIDI CCs#70–79 have fixed assignments to control basic Program parameters, for quick and simple control of timbre. You can use these CCs from MIDI, or from the front-panel controls.

RT control knobs (SOUND) are always assigned to four of these CCs, as shown below:

| | |
|------------|------------------------|
| CUT/OFF | CC#74–Filter Cutoff |
| RESONANCE | CC#71–Filter Resonance |
| EG INT | CC#79–EG Intensity |
| EG RELEASE | CC#72–EG Release Time |

RT control knob (USER) can be assigned to various functions, including any of the CCs#70-79.

The specific parameters controlled by the CCs will vary depending on the synth algorithm being used, as shown in the tables below:

- “HD-1” on page 926
- “AL-1 and STR-1” on page 926
- “CX-3” on page 927
- “MS-20EX” on page 927
- “PolysixEX” on page 927
- “MOD-7” on page 927

- “SGX-2” on page 928
- “EP-1” on page 928

These CCs modulate the underlying parameters, instead of editing them directly. In most cases, a value of 64 (knob pointing straight up) is equal to the programmed parameter value; turning the CC down to 0 reduces the parameter to its minimum value, and turning the CC up to 127 increases the parameter to its maximum value. In other cases, such as some EG parameters, the action of the CC may be more complex.

In PROGRAM mode, these modulated values can be stored back into the parameters, if desired. Just use the **Write Program** menu command, and the modulation will be converted into the underlying parameter values, over-writing the previous settings. After doing this, the CCs will be reset to 64.

In SAMPLING mode, these CCs will modulate their parameters just as in PROGRAM mode. You can use the **Convert MS to Program** menu command to save the current state as a Program, in which case the modulation will be converted into the underlying parameter values.

In COMBINATION and SEQUENCER modes, the CCs will modulate the parameters for all Timbres or Tracks on a given MIDI channel. However, edits made in this way cannot be saved back into a Program.

| CC# | Internal parameters controlled by the CC |
|------------------------------|---|
| 70 (Sustain level) | Filter EG 1/2 Sustain (see page 71) Amp EG 1/2 Sustain (see page 79) |
| 71 (Filter resonance) | Filter A/B, 1/2 Resonance (see page 64) |
| 72 (Release time) | Filter EG 1/2 Release (see page 71) Amp EG 1/2 Release (see page 80) |
| 73 (Attack time) | EG Times: Filter EG 1/2 Attack (see page 71) Amp EG 1/2 Attack (see page 80) Amp EG 1/2 Time Modulation: Attack (see page 81) EG Levels: Amp EG 1/2 Level Start (see page 79) Amp EG 1/2 Level Attack (see page 79) Amp EG 1/2 Level Modulation: Start (see page 81) |
| 74 (Filter cutoff frequency) | Filter A/B, 1/2 Frequency (see page 63) |
| 75 (Decay time) | Filter EG 1/2 Decay (see page 71) Filter EG 1/2 Slope (see page 71) Amp EG 1/2 Decay (see page 80) Amp EG 1/2 Slope (see page 80) |
| 76 (LFO1 speed) | LFO 1 Frequency (see page 84) |
| 77 (LFO1 Pitch intensity) | Pitch LFO1 Intensity (see page 56) |
| 78 (LFO1 delay) | LFO 1 Delay (see page 85) |
| 79 (Filter EG intensity) | Filter EG 1/2 Intensity to A (see page 67) Filter EG 1/2 Intensity to B (see page 67) |

AL-1 and STR-1

| | |
|-----------------------|---|
| 70 (Sustain level) | EG 1 (Filter) Sustain (see page 170) Amp EG Sustain (see page 166) |
| 71 (Filter resonance) | Filter A&B Resonance (see page 157) |
| 72 (Release time) | EG 1 (Filter) Release (see page 170) Amp EG Release (see page 167) |

| | |
|------------------------------|---|
| 73 (Attack time) | EG Times: EG 1 (Filter) Attack (see page 170) Amp EG Attack (see page 167) Amp EG Time Modulation: Attack (see page 167) EG Levels: Amp EG Start (see page 166) Amp EG Attack (see page 166) Amp EG Level Modulation: Start (see page 167) |
| 74 (Filter cutoff frequency) | Filter A&B Frequency (see page 157) |
| 75 (Decay time) | EG 1 (Filter) Decay (see page 170) EG 1 (Filter) Slope (see page 170) Amp EG Decay (see page 167) Amp EG Slope (see page 167) |
| 76 (LFO1 speed) | LFO1 Frequency (see page 176) |
| 77 (LFO1 Pitch intensity) | Pitch LFO Intensity (see page 151) |
| 78 (LFO1 delay) | LFO1 Delay (see page 177) |
| 79 (Filter EG intensity) | Filter A&B EG Intensity (see page 159) |

CX-3

| | |
|---------|-------------------------|
| 70...79 | No supported parameters |
|---------|-------------------------|

MS-20EX

| | |
|------------------------------|--|
| 70 (Sustain level) | EG2 SUSTAIN LEVEL (see page 265) |
| 71 (Filter resonance) | LPF PEAK (see page 261) |
| 72 (Release time) | EG2 RELEASE TIME (see page 265) |
| 73 (Attack time) | EG2 ATTACK TIME (see page 265) |
| 74 (Filter cutoff frequency) | LPF FREQUENCY (see page 261) |
| 75 (Decay time) | EG2 DECAY TIME (see page 265) |
| 76 (LFO1 speed) | LFO1 Frequency (see page 176) |
| 77 (LFO1 Pitch intensity) | FREQUENCY MODULATION MG/T.EXT (see page 260) |
| 78 (LFO1 delay) | LFO1 Delay (see page 177) |
| 79 (Filter EG intensity) | LPF EG2/EXT (see page 261) |

PolysixEX

| | |
|------------------------------|-------------------------------------|
| 70 (Sustain level) | PolysixEX EG SUSTAIN (see page 289) |
| 71 (Filter resonance) | VCF RESONANCE (see page 288) |
| 72 (Release time) | PolysixEX EG RELEASE (see page 289) |
| 73 (Attack time) | PolysixEX EG ATTACK (see page 289) |
| 74 (Filter cutoff frequency) | VCF CUTOFF (see page 288) |
| 75 (Decay time) | PolysixEX EG DECAY (see page 289) |
| 76 (LFO1 speed) | LFO1 Frequency (see page 176) |
| 77 (LFO1 Pitch intensity) | VIBRATO INT (see page 287) |
| 78 (LFO1 delay) | LFO1 Delay (see page 177) |
| 79 (Filter EG intensity) | VCF EG INTENSITY (see page 288) |

MOD-7

| | |
|-----------------------|---|
| 70 (Sustain level) | EG 8 (Filter) Sustain (see page 341) Amp EG Sustain (see page 166) |
| 71 (Filter resonance) | Filter A&B Resonance (see page 157) |
| 72 (Release time) | EG 8 (Filter) Release (see page 341) Amp EG Release (see page 167) |

| | |
|------------------------------|---|
| 73 (Attack time) | EG Times: EG 8 (Filter) Attack (see page 341) Amp EG Attack (see page 167) Amp EG Time Modulation: Attack (see page 167) EG Levels: Amp EG Start (see page 166) Amp EG Attack (see page 166) Amp EG Level Modulation: Start (see page 167) |
| 74 (Filter cutoff frequency) | Filter A&B Frequency (see page 157) |
| 75 (Decay time) | EG 8 (Filter) Decay (see page 341) EG 8 (Filter) Slope (see page 170) Amp EG Decay (see page 167) Amp EG Slope (see page 167) |
| 76 (LFO1 speed) | LFO1 Frequency (see page 176) |
| 77 (LFO1 Pitch intensity) | EG 8 (Filter) Sustain (see page 341) Amp EG Sustain (see page 166) |
| 78 (LFO1 delay) | Filter A&B Resonance (see page 157) |
| 79 (Filter EG intensity) | Filter A&B EG Intensity (see page 159) |

SGX-2

| | |
|------------------------------|-----------------------------|
| 72 (Release time) | Release Time (see page 353) |
| 74 (Filter cutoff frequency) | Lid Position (see page 353) |

EP-1

| | |
|---------|-------------------------|
| 70...79 | No supported parameters |
|---------|-------------------------|

MIDI applications

About MIDI

MIDI stands for Musical Instrument Digital Interface, and is a world-wide standard for exchanging various types of musical data between electronic musical instruments and computers. When MIDI cables are used to connect two or

more MIDI devices, performance data can be exchanged between the devices, even if they were made by different manufacturers.

Connecting MIDI devices & computers

Controlling an external MIDI tone generator from the NAUTILUS

When you wish to use the NAUTILUS's keyboard, controllers, and sequencer etc. to play an external MIDI tone generator, use a MIDI cable to connect the NAUTILUS's MIDI OUT connector to the MIDI IN connector of the external MIDI tone generator.

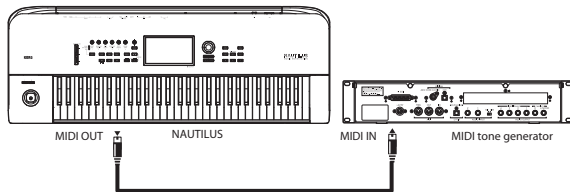

Controlling the NAUTILUS's tone generator from an external MIDI device

When you wish to play or control the NAUTILUS's tone generator from an external MIDI keyboard or sequencer etc., use a MIDI cable to connect the MIDI OUT connector of the external MIDI device to the MIDI IN connector of the NAUTILUS.

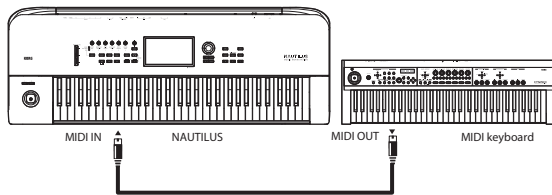

Controlling two or more external MIDI tone generators from the NAUTILUS

You can use the MIDI THRU jack to simultaneously control multiple MIDI devices. (This type of connection should be used to connect no more than three devices. If you wish to connect a larger number of MIDI devices, we recommend that you use a MIDI patch bay as shown in the second diagram below.)

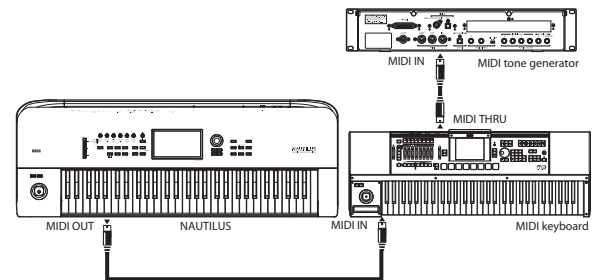

You can also use a MIDI patch bay to control multiple MIDI devices.

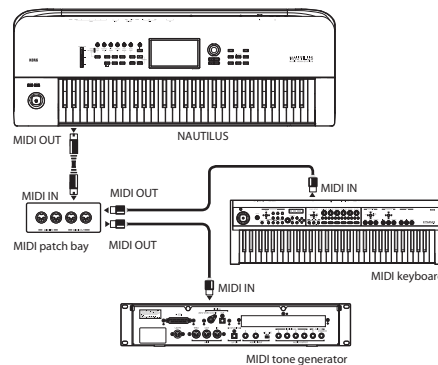

The "Convert Position" setting

On the NAUTILUS, **Key Transpose**, **Velocity Curve** and **After Touch Curve** (MIDI IN) (GLOBAL 0-1a) allow you to transpose the pitch, and adjust the velocity sensitivity.

The effect that these settings will have on the internal sequencer and on the MIDI data that is transmitted and received will depend on "Convert Position" (GLOBAL 1-1a) setting.

- If you want to control an external MIDI tone generator from the NAUTILUS, set "Convert Position" to Pre MIDI. The various settings listed above will be reflected in the MIDI data that is transmitted. These settings will also be reflected in the data that is recorded on the internal sequencer.

Incoming MIDI data will be handled with settings equivalent to **Key Transpose 0**, **Velocity Curve 4**, and **After Touch Curve 3**.

- When controlling the NAUTILUS's tone generator from an external MIDI device, select Post MIDI. The above-listed settings will affect the MIDI data that is received. These settings will also affect the data that is played back from the internal sequencer.

Outgoing MIDI data will be handled with settings equivalent to **Key Transpose 0**, **Velocity Curve 4**, and **After Touch Curve 3**.

Connecting an external MIDI sequencer or computer

You can play the NAUTILUS's keyboard and record your performance on an external MIDI sequencer/computer (connected via a MIDI interface), and then play back the recorded performance to sound the NAUTILUS's tone generator (i.e., using the NAUTILUS as an input keyboard and MIDI tone generator). To do this, connect the MIDI OUT and MIDI IN connectors of the NAUTILUS and your external MIDI sequencer/ computer to each other.

As an alternative to MIDI, you can connect the NAUTILUS directly to the computer via USB, using the NAUTILUS' USB B port.

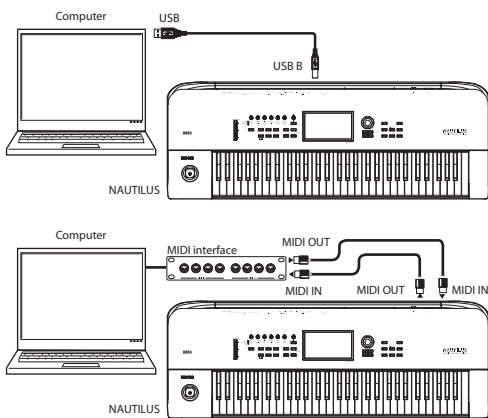

Local Control On settings

When connections are made as shown above, turn on the Echo Back function of the external MIDI sequencer or computer (so that data received at MIDI IN will be re-transmitted from MIDI OUT), and turn off the NAUTILUS's Local Control setting (so that the NAUTILUS's keyboard and tone generator will be internally disconnected).

USB MIDI controllers

Overview

The NAUTILUS supports direct connection of USB MIDI class compliant devices to the rear-panel USB A ports. Multiple USB MIDI controllers can be connected simultaneously, if desired.

The NAUTILUS provides no user interface for USB controllers. Any settings stored in the controller, including controller assignments, MIDI channel, and so on will apply in the communication between the controller and the NAUTILUS. If the controller supports different internal setups (such as Scenes on Korg devices), you can switch between them to change the controller's functionality.

In general, USB MIDI controllers can be used just like normal MIDI controllers connected to the standard MIDI In jack (though there are a few limitations, as described below). If the controller is set to a different MIDI channel than the NAUTILUS's Global MIDI Channel, you can use it to play a

different sound than the local keyboard in Combinations or Songs, as controlled by the Timbre or Track MIDI settings. You can also play the Drum Track Program in PROGRAM mode, while still playing the main Program from the keyboard, by setting the pads to send on the Drum Track's MIDI channel (see "Prog MIDI Ch" on page 656).

Bus-powered devices are supported, subject to the current limits defined by the USB specification. For more information, see "USB Power" on page 22 of the OG.

Limitations of USB MIDI device support
MIDI clock is not supported from USB MIDI devices.

System Exclusive messages from USB MIDI devices are limited to 16-bytes. Additionally, certain messages are not supported, such as mode changes and dump requests.

When you play the keyboard of the NAUTILUS, the musical data will be transmitted to the external MIDI sequencer or computer, and then echoed back to play the NAUTILUS's tone generator. In other words, by turning Local Control OFF, you can prevent notes from being sounded in duplicate, as would otherwise occur if a note were sounded by the NAUTILUS's own keyboard and again by the data that was echoed-back.

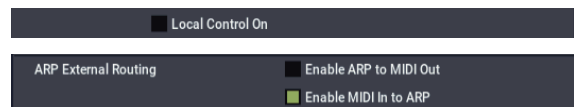

To turn off Local Control, press the "Local Control On" (GLOBAL 1-1a) check box to uncheck it.

When using the NAUTILUS by itself, leave Local Control turned on. (If this is off when the NAUTILUS is used by itself, playing the keyboard will not produce sound.)

When using Arpeggiator, the Global **ARP External Routing** settings and the local control on/off setting will determine how the function is controlled, as follows. For more information, see "ARP External Routing" on page 654.

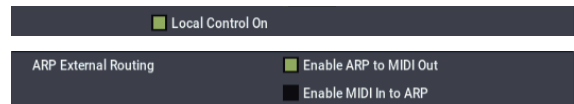

Here are the settings to use if you want an external MIDI sequencer or computer to record only the notes that trigger Arpeggiator, and control Arpeggiator using the notes that are echoed-back during recording or playback.

When Arpeggiator is turned on, playing the NAUTILUS' keyboard will not trigger Arpeggiator; the notes you play on the keyboard will only be transmitted. Arpeggiator will operate only on the notes that are echoed-back and received at MIDI IN. This prevents Arpeggiator from being applied in duplicate, and ensures that it will operate correctly.



Here are the settings to use if you want the note data generated by Arpeggiator to be transmitted via MIDI and recorded on your external sequencer or computer.

different sound than the local keyboard in Combinations or Songs, as controlled by the Timbre or Track MIDI settings. You can also play the Drum Track Program in PROGRAM mode, while still playing the main Program from the keyboard, by setting the pads to send on the Drum Track's MIDI channel (see "Prog MIDI Ch" on page 656).

Bus-powered devices are supported, subject to the current limits defined by the USB specification. For more information, see "USB Power" on page 22 of the OG.

Limitations of USB MIDI device support

MIDI clock is not supported from USB MIDI devices.

System Exclusive messages from USB MIDI devices are limited to 16-bytes. Additionally, certain messages are not supported, such as mode changes and dump requests.

Messages transmitted and received by the NAUTILUS

In the text below, [...] indicates hexadecimal notation.

MIDI channels

MIDI messages can be exchanged when the transmitting and receiving devices are set to the same MIDI channel. MIDI uses sixteen channels, numbered 1–16. The way in which channels are handled will differ depending on the mode.

PROGRAM mode and SAMPLING mode

- Transmission/reception is performed on the global MIDI channel.

The global MIDI channel is the basic channel that the NAUTILUS uses for MIDI transmission/reception, and is set by **MIDI Channel** (GLOBAL 1–1a).

COMBINATION mode

- The global MIDI channel is used to transmit/ receive messages for selecting a combination and turning effects on/off, and to transmit/receive exclusive data.
- Each timbre will transmit/receive MIDI data on the **MIDI Channel** (COMBINATION 2–1a) that is specified for that timbre.
- The **Ch** MIDI channel specified for each effect (COMBINATION 8–7a, 9–2a, 9–3, 9–4, 9–5) is used to control dynamic modulation of the insert/master/ total effects, the pan following the insert effect, and send 1 and 2.
- When you operate the keyboard or controllers of the NAUTILUS, messages will be transmitted on the global MIDI channel, and will also be transmitted on the MIDI channel of any timbre whose **Status** (COMBINATION 2–1a) is set to EXT or EX2.
- Channel messages will be received if they match the MIDI channel of a timbre whose **Status** is set to INT (COMBINATION 2–1a).

SEQUENCER mode

- The global MIDI channel is used to transmit/ receive exclusive data and for messages that switch effects on/off.
- MIDI data transmission/reception for each MIDI track will occur on the MIDI channel specified for each MIDI track by **MIDI Channel** (SEQUENCER 2–1a).
- The MIDI channel specified for each effect by the **Ch** parameter (SEQUENCER 8–7a, 9–2a, 9–3, 9–4, 9–5) is used to control dynamic modulation of the insert/master/total effects, the pan following the insert effect, and send 1 and 2.
- When you operate the keyboard or controllers of the NAUTILUS, messages will be transmitted on the MIDI channel selected by **Track Select** (SEQUENCER 0–1a). However, messages will be transmitted only if the selected MIDI track has a **Status** of Both, EXT, or EX2. For more information, see “Track Select” on page 445.



If you've selected Audio Track 1–16 in the Track Select field, this will apply to the MIDI track you selected most recently. The Track Information field will indicate “KBD.”

- When the sequencer is played back, musical data of MIDI tracks whose **Status** is Both, EXT, or EX2 will be transmitted on the specified MIDI channels.
- MIDI tracks whose **Status** is INT or Both will receive channel messages of the matching MIDI channel. For more information, see “Status” on page 478, and “MIDI Channel” on page 479.

Note on/off

Note-on [9n, kk, vv]

Note-off [8n, kk, vv]

(n: channel, kk: note number, vv: velocity)

When you play a note on the NAUTILUS's keyboard, it will transmit note-on/off messages.

While Arpeggiator is operating, the note-on/off data generated by Arpeggiator will be transmitted. (“Local Control On settings” on page 930)

However, most instruments do not receive or transmit note-off velocity, and neither does the NAUTILUS.

Program Change/Bank Select

Changing the program/bank

Program change [Cn, pp]

(n: channel, pp: program number that allows 128 sounds to be selected)

- Programs 000–127 in banks A...T correspond to program changes [Cn, 00]–[Cn, 7F].
- Programs 001–128 in banks G, g(1), g(2), g(3), g(4), g(5), g(6), g(7), g(8), g(9), and g(d) correspond to program changes [Cn, 00]–[Cn, 7F].

Bank select MSB (CC#0) [Bn, 00, mm]

Bank select LSB (CC#32) [Bn, 20, bb]

(n: channel, mm: bank number upper byte, bb: bank number lower byte)

- The internal banks that correspond to each bank select number will depend on the “Bank Map” setting (GLOBAL 0–1d). Korg is the default setting. For more information, see “Bank Map” on page 633.

Simply receiving a Bank Select message will not cause the program or bank to change. The program or bank will actually change when a Program Change message is received.

PROGRAM mode

- In PROGRAM > Home page, program change and bank select messages are transmitted and received on the global MIDI channel. These messages are not received except in Home page.

COMBINATION and SEQUENCER modes

- Program change and bank select messages can be received on the MIDI channel specified for each timbre/MIDI track to select programs on that timbre/track.
- When you select a combination, program change and bank select messages will be transmitted by timbres whose **Status** is EXT or EX2.

In SEQUENCER mode, program change or bank select messages will be transmitted by tracks whose **Status** is Both, EXT, or EX2 when you select the “Program Select” parameter (0–1b), when you select a song, or when you return to the beginning of a measure. (See “0–1b: Status Play/Mute” on page 446.)

- In COMBINATION and SEQUENCER modes, transmission/reception can be switched on/off for each timbre/track. See “Enable Program Change” on page 413, and “Enable Program Change” on page 489.

SET LIST mode

- Program Change messages on the Global Channel select the Slot, and Bank Select messages on the Global Channel select the Set List.

When a Slot is selected via MIDI, the display updates if necessary to show the appropriate group of 16 buttons.

- Selecting a Slot sends Program Change and Bank Select messages, as above.

When selected, Combinations and Songs can transmit other Program Change and Bank Select messages on other channels, as they do in COMBINATION and SEQUENCER modes.

- The GLOBAL > Basic Setup– **Bank Map** (Korg, GM(2)) parameter does not affect the reception or transmission of Set List Program and Bank Select messages.

Selecting combinations

You can use program change and bank select messages to select combinations in the same way that you select programs.

- Combinations 000–127 in banks A...N correspond to program changes [Cn, 00]–[Cn, 7F].
- Similarly as for program banks, the internal banks that correspond to each bank select number will depend on the “Bank Map” setting (GLOBAL 0–1d). For more information, see “Bank Map” on page 633.
- In COMBINATION > Home page, program change and bank select messages are transmitted/received on the global MIDI channel. They are not received except in Home page.

Note: All program changes can be turned off in MIDI Filter (GLOBAL 1–1c)

As needed, you can independently turn all program changes on/off, specify whether or not incoming messages will be able to change combinations, and turn reception/transmission of bank select messages on/off.

- If “Enable Combination Change” (GLOBAL 1–1c) is unchecked, the combination will not change even if a program change on the global MIDI channel is received in COMBINATION P0: Play. In this case, the program of the timbre that matches the MIDI channel of the received message will change.
- If “Enable Bank Change” (GLOBAL 1–1c) is unchecked, bank select messages will not be transmitted or received.

Aftertouch

Channel aftertouch [Dn, vv]

(n: channel, vv: value)

- After touch for the entire instrument can be turned on/off in “Enable After Touch” (GLOBAL 1–1c).
- In COMBINATION and SEQUENCER modes, after touch can be switched on/off independently for each timbre/track (“Enable After Touch” COMBINATION 3–1a, SEQUENCER 3–1a).

Polyphonic aftertouch [An, kk, vv]

(n: channel, kk: note number, vv: value)

There is another type of after touch called Polyphonic Key Pressure, which allows after touch to be applied independently for individual keys. This message can be used as an alternate modulation source, but cannot be transmitted by the NAUTILUS’s keyboard. In order to use this message, it will have to be received from an external device, or recorded on your sequencer.

Pitch bend

Pitch bend change [En, bb, mm]

(n: channel, bb: lower byte of the value, mm: upper byte of the value, together expressing a value of 16,384 steps where 8,192 [bb, mm = 00H, 40H] is the center value)

When the NAUTILUS’s joystick is moved in the X axis (left/right), a pitch bend effect will be applied, and pitch bender messages will also be transmitted. When these messages are received, a pitch bend effect will be applied.

The range of pitch change that is produced by pitch bend messages can also be adjusted via MIDI. (See “Changing the pitch bend range” on page 936.)

Control change

[Bn, cc, vv]

Transmitted and received as (n: channel, cc: control change no., vv: value)

For more information, see “MIDI transmission from NAUTILUS controllers” on page 920, and “NAUTILUS and MIDI CCs” on page 923

- Control changes can be turned on/off as a whole in “Enable Control Change” (GLOBAL 1–1c).
- In COMBINATION and SEQUENCER modes, the MIDI Filter/Zones– MIDI Filter settings allow transmission/reception of control changes to be individually turned on/off for each timbre/track. For the assignable controllers (SW1, SW2, RT control knobs 1–6, Foot Pedal/Switch), MIDI filter settings will apply to the control change number to which each controller is assigned. “Other Control Change” applies to control changes that are not covered by the items of the other check boxes.

Note: You can select MIDI CC#00–CC#119 for “RT control knobs 1...6.”

Although you can select MIDI CC#00–CC#119 for the ARP controllers (ARP button, LATCH button, DRUM button, SELECT button is the RT control knob when ARP DRUM) and the X-Y Control, you will normally use the default

settings that are assigned when you execute GLOBAL > Controllers/Scales– the page menu command “Reset Controller MIDI Assign” with Default Setting, and leave ARP Controllers turned Off, X-Y Control X” at CC#118, and “X-Y Control Y” at CC#119.

If you assign a CC# to ARP controllers, use the same CC#s as when “Reset Controller MIDI Assign” is executed with the CC Default setting.

Selecting program/combination banks

Bank select (CC#00, CC#32)

Technically, Bank Select is a controller. In practice, however, it is a component of Program Change. For more information, see “Program Change/Bank Select” on page 931)

Using the joystick to apply modulation

Modulation 1 depth (CC#01) [Bn, 01, vv]

When you move the NAUTILUS’s joystick in the +Y direction (Vertical upward), Modulation 1 Depth messages will be transmitted. When these messages are received, the same effect will be applied as when the NAUTILUS’s joystick is operated. Normally this will apply a vibrato effect (pitch LFO).

- In COMBINATION and SEQUENCER modes, transmission/reception can be switched on/off for each timbre/track (“Enable JS+Y” COMBINATION/SEQUENCER 3–1a).

Modulation 2 depth (CC#02) [Bn, 02, vv]

When you move the NAUTILUS’s joystick in the –Y direction (Vertical downward), Modulation 2 Depth messages will be transmitted. When these messages are received, the same effect will be applied as when the NAUTILUS’s joystick is operated. Normally this will apply a wah effect (filter LFO).

- In COMBINATION and SEQUENCER modes, transmission/reception can be switched on/off for each timbre/track (“Enable JS-Y” COMBINATION/SEQUENCER 3–1a).

Other manufacturers use this message for other purposes (e.g., breath controller, etc.)

Controlling portamento

Portamento time (CC#05) [Bn, 05, vv]

If you assign the above CC# to a RT control knobs 1–6 function, rotating that knob will transmit Portamento Time messages, and will modify the speed at which the portamento pitch changes. When this message is received, the result will be the same as when the controller is operated.

Portamento switch (CC#65) [Bn, 41, vv]

When the above CC# is assigned to SW1, SW2 or the ASSIGNABLE SWITCH, operating that switch will transmit vv=127 [7F] for ON or vv=0 [00] for OFF, and the portamento effect will be switched on/off. When this message is received, the result will be the same as when the controller is operated. (vv of 63 [3F] or less will be OFF, and 64 [40] or greater will be ON.) (See “SW1/2 Assignments” on page 915)

- In COMBINATION and SEQUENCER modes, transmission/reception of this message can be turned on/off independently for each timbre/track (“Enable Portamento SW” COMBINATION/SEQUENCER 3–1a).
- In SEQUENCER mode, portamento time/switch messages will be transmitted by each track whose **Status** is Both, EXT, or EX2 when you set “Portamento” (2–2a), re-select a song or SMF, or return to the beginning of a measure. For more information, see “Portamento” on page 480.

Controlling volume

Volume (CC#07) [Bn, 07, vv]

When the above CC# is assigned to the ASSIGNABLE PEDAL or as the RT control knobs 1–6 function, operating that controller will transmit Volume messages, and the volume will change. When this message is received, the result will be the same as when the controller is operated.

Expression (CC#11) [Bn, 0B, vv]

When the above CC# is assigned to the ASSIGNABLE PEDAL or as the RT control knobs 1–6 or as the X-Y CC control function, operating that controller will transmit Expression messages, and the volume will change. When this message is received, the result will be the same as when the controller is operated.

The volume of the NAUTILUS is determined by multiplying the value of the Volume message with the value of the Expression message.

If adjusting the Volume message does not increase the volume as you expect, or if there is no sound, transmit MIDI messages from an external device to reset the value of the Expression message (set vv to 127).

Note: In SEQUENCER mode, this will be reset when the “Location” of the song is moved to 001:01.000.

- In COMBINATION mode, Volume messages will be transmitted by each timbre whose **Status** is EXT or EX2 when you re-select the combination.
- When you change the **Volume** setting (SEQUENCER 0–1b) in SEQUENCER mode, or when you re-select the song or return to the beginning of the song in SEQUENCER mode, volume messages will be transmitted by each track whose **Status** is Both, EXT, or EX2.

Note: Regardless of the **Status** settings, re-selecting a song, or returning to the beginning will reset the internal Volume value to the value specified by each track (the starting settings), and will reset the Expression value to the maximum.

Note: This message can be used to control the volume of each MIDI track. Normally, you will include a Volume message in the MIDI track setting data (the settings at the beginning of the track) to set the initial volume, and use Expression to create changes in dynamics as the song progresses.

By using the universal exclusive Master Volume message, you can adjust the overall volume without changing the volume balance between timbres or tracks (see “About system exclusive messages” on page 936).

Controlling pan (stereo position)

Pan (CC#10) [Bn, 0A, vv]

(vv: value, where 00 is far left, 64 is center, and 127 is far right)

When the above CC# is assigned to the foot pedal or the RT control knobs 1–6, operating that controller will transmit Pan messages, and the panning will change. When this message is received, the result will be the same as when the controller is operated.

- When you set the **Pan** (SEQUENCER 0–1b) in SEQUENCER mode, or when you re-select the song or return to the beginning of the measure in SEQUENCER mode, Panpot messages (except for RND) will be transmitted by each track whose **Status** is Both, EXT, or EX2. For more information, see “Pan” on page 447.

Post insert effect pan (CC#08) [Bn, 08, vv]

(vv: value, where 00 is far left, 64 is center, and 127 is far right)

When the above CC# is assigned to the ASSIGNABLE PEDAL, as the RT control knobs 1–6, or CC Control, operating that controller will transmit Post Insert Effect Panpot messages, and the panning of the sound following the insert effect will change. When this message is received, the result will be the same as when the controller is operated.

- In PROGRAM mode and SAMPLING mode, this message is transmitted/received on the global MIDI channel. In COMBINATION, and SEQUENCER modes, this message is transmitted/received on the MIDI channel specified for each insert effect.
- When you set “Pan (CC#8)” (SEQUENCER 8–5a) in SEQUENCER mode, or when you re-select the song or return to the beginning of the measure in SEQUENCER mode, Post Insert Effect Panpot messages will be transmitted by each track whose **Status** is Both, EXT, or EX2. For more information, see “8–5a: IFX” on page 513.

Controlling effects

Effect Control 1 (CC#12) [Bn, 0C, vv]

Effect Control 2 (CC#13) [Bn, 0D, vv]

These CCs are used for effects dynamic modulation (Dmod), and can be programmed to control various effects parameters. Note that other CCs can also be used as Dmod sources, if desired.

Effect control 1 and 2 can be assigned to the ASSIGNABLE PEDAL, RT control knobs 1–6, or CC Control.

Effect 1 depth (Send 2) (CC#91) [Bn, 5B, vv]

Effect 3 depth (Send 1) (CC#93) [Bn, 5D, vv]

These CCs control the per-Osc/Timbre/Track and post-IFX send levels for Master Effects 1 and 2. In COMBINATION and SEQUENCER modes, the channel used to control post-IFX send levels is the channel of the Timbres/Tracks routed through the IFX, instead of the effect’s Control Channel.

These CCs can be assigned to the ASSIGNABLE PEDAL, RT control knobs 1–6, or CC Control.

- In COMBINATION and SEQUENCER modes, the actual send level of the timbre/track is determined by multiplying this value with the Program’s per-Oscillator

Send 1/2 settings. For more information, see “OSC1 Send1 (to MFX1)” on page 99.

- In SEQUENCER mode, when you adjust **Send 1 (MFX1)** or **Send 2 (MFX2)**, or when you re-select a song or return to the beginning of the measure, Send 1/2 will be transmitted by each track whose **Status** is Both, EXT, or EX2.

Effect 2 depth (IFX1–12 on/off) (CC#92) [Bn, 5C, vv]

Effect 4 depth (MFX1, 2 on/off) (CC#94) [Bn, 5E, vv]

Effect 5 depth (TFX1, 2 on/off) (CC#95) [Bn, 5F, vv]

Separately from the effect on/off settings in each mode, the **Effect Global SW** allows you to turn off insert effects IFX1–12 and master effects MFX1, 2 and total effect TFX1, 2 (see “0–1b: Effect Global SW” on page 633).

If you check **IFX1–12 Off**, **MFX1&2 Off** or **TFX1&2 Off**, the corresponding message will be transmitted with vv=0 [00]. If you uncheck these settings, the corresponding message will be transmitted with vv=127 [7F]. If you check these settings, the corresponding effect(s) will be turned off as a group. If you uncheck these settings, the on/off settings of each mode will be used. The same applies to reception. (vv of 00 is off, and 01 or greater is the original setting.) These messages are transmitted and received on the global MIDI channel.

Note: These messages are defined simply for use in adjusting the effect levels, and may not have the same function on another instrument connected to the NAUTILUS.

Using various controllers

Here we will explain typical ways to use the various controllers.

Foot controller (CC#04) [Bn, 04, vv]

If the above CC# is assigned as the ASSIGNABLE PEDAL function, this message will be transmitted when the controller is operated.

- In COMBINATION and SEQUENCER modes, you can use the MIDI Filters to enable and disable transmission/reception of this message for each timbre/track. For more information, see “Enable Foot Pedal” on page 416.

RT control knobs 1–6 (CC#73, 75, 70, 72, 76, 77) [Bn, 49, vv], [Bn, 4B, vv], [Bn, 46, vv], [Bn, 48, vv], [Bn, 4c, vv], [Bn, 4D, vv]

When the SELECT button is set to “USER” for the RT control knob functions, the CC# messages above are set and will be sent when operating these knobs on the NAUTILUS.

- In COMBINATION and SEQUENCER modes, transmission/reception of this message can be turned on/off independently for each timbre/track (“Enable RT Controls Knobs 1–6” COMBINATION/SEQUENCER 3–2a).

Controller (CC#83) [Bn, 53, vv]

If you assign the above CC# to a RT control knob function, this message will be transmitted when you operate the corresponding controller of the NAUTILUS.

Damper pedal (CC#64) [Bn, 40, vv]

This message is transmitted when you operate a damper pedal (Korg DS-1H etc.) connected to the DAMPER jack, and the damper effect will be turned on/off. If the DS-1H is used, a half-damper effect can be applied.

- In COMBINATION and SEQUENCER modes, transmission/reception of this message can be turned on/off independently for each timbre/track (“Enable Damper” COMBINATION/SEQUENCER 3–1a).

SW1 modulation (CC#80) [Bn, 50, vv]**SW2 modulation (CC#81) [Bn, 51, vv]**

If the above CC# are assigned as the function of SW1 or SW2, operating the switch will transmit this message with vv=127 [7F] for ON, and vv=00 [00] for OFF.

- In COMBINATION and SEQUENCER modes, transmission/reception of these messages can be turned on/off independently for each timbre/track (“Enable SW1,” “Enable SW2” COMBINATION/SEQUENCER 3–3a)

Foot switch (CC#82) [Bn, 52, vv]

If the above CC# is assigned as the function of the ASSIGNABLE SWITCH, operating the switch will transmit this message with vv=127 [7F] for ON, and vv=00 [00] for OFF.

- In COMBINATION and SEQUENCER modes, transmission/reception of this message can be turned on/off independently for each timbre/track (“Enable Foot Switch” COMBINATION/SEQUENCER 3–3a).

Sostenuto (CC#66) [Bn, 42, vv]

If the above CC# is assigned as the function of the ASSIGNABLE SWITCH, operating the switch will transmit this message with vv=127 [7F] for ON, and vv=00 [00] for OFF, and the sostenuto effect will be turned on/off. When this message is received, the result will be the same as when the controller is operated (OFF for vv=63 [3F] or below, and ON for vv=64 [40] or above).

Soft pedal (CC#67) [Bn, 43, vv]

If the above CC# is assigned as the function of the ASSIGNABLE SWITCH, operating the switch will transmit, and the soft pedal effect will be turned on. When this message is received, the result will be the same as when the controller is operated.

When “Foot controller (CC#04)”–“Soft pedal (CC#67)” are operated on the NAUTILUS, the specified alternate modulation or dynamic modulation etc. will be controlled. When these messages are received, the result will be the same as if the controller had been operated. For “SW1 modulation (CC#80)”–“Soft pedal (CC#67),” vv of 63 [3F] or less will be OFF, and 64 [3F] or greater will be ON.

Controlling Program tone & envelope shapes

CC#70–79 control specific parameters of a program.

For details on the program parameters that correspond to each control change, and how the NAUTILUS will respond in each mode when these are received, refer to “NAUTILUS and MIDI CCs” on page 923.

Filter cutoff (CC#74) [Bn, 4A, vv]**Resonance level (CC#71) [Bn, 47, vv]****Filter EG intensity (CC#79) [Bn, 4F, vv]****Release time (CC#72) [Bn, 48, vv]**

These messages are transmitted when you operate the NAUTILUS’s RT control knobs 1–4.

Sustain level (CC#70) [Bn, 46, vv]**Attack time (CC#73) [Bn, 49, vv]****Decay time (CC#75) [Bn, 4B, vv]****LFO 1 speed (CC#76) [Bn, 4C, vv]****LFO 1 depth (pitch) (CC#77) [Bn, 4D, vv]****LFO 1 delay (CC#78) [Bn, 4E, vv]**

These messages are transmitted when assign the above CC# to the RT control knobs function.

When you operate these, the corresponding program parameters will be controlled, and the sound and envelope will change. When these messages are received, the result will be the same as when the controller is operated. (When the message has a value vv=64 [40], the setting will have the value that was set by the program parameter.)

- In COMBINATION and SEQUENCER modes, transmission/reception can be turned on/off independently for each timbre/track (“Enable Realtime Controls Knob 1...6” COMBINATION/SEQUENCER 3–2a).

Note: In PROGRAM mode, the corresponding program parameters will be temporarily edited by these messages. You can Write the program to save the modified state (except for certain parameters). The Write operation can also be performed by a MIDI System Exclusive Program Write Request message, in addition to the usual method of using the NAUTILUS’s switches. When you write the data, the values of the corresponding program parameters will be rewritten.

Note: The results of receiving these messages will depend on the instrument. The operation may be different when a device other than the NAUTILUS is connected.

Using RPN (Registered Parameter Numbers)

RPN (Registered Parameter Numbers) are a type of message that allow settings to be made in a way that is common between instrument manufacturers. (NRPN (Non-registered Parameter Numbers) and exclusive messages can be freely used in non-compatible ways by different manufacturers and models of instrument.)

RPN messages can be used for editing with the following procedure.

1. Use RPN MSB (CC#101) [Bn, 65, mm] and RPN LSB (CC#100) [Bn, 64, rr] (n: channel, mm, rr: upper and lower bytes of the parameter number) messages to select the parameter.

2. Use data entry MSB (CC#6) [Bn, 06, mm] and data entry LSB (CC#38) [Bn, 26, vv] (n: channel, mm, vv: upper and lower bytes of the value, together expressing 16,384 levels) to specify the value.
3. You can use data increment (CC#96) [Bn, 60, 00] or data decrement (CC#97) [Bn, 61, 00] (n: channel, value is fixed at 00) to change the value in steps of one.

The NAUTILUS can receive the following three RPN messages, described in detail below: tuning, transpose, and pitch bend range.

Tuning

RPN fine tune [Bn, 65, 00, 64, 01]

This RPN message adjusts the detuning for Programs, Combination Timbres, and Sequencer Tracks.

The procedure is as follows.

1. [Bn, 65, 00, 64, 01]: Select RPN parameter 01.
2. [Bn, 06, mm, 26, vv]: Use data entry to set the value. A value of 8192 [mm, vv=40, 00] is center, 0 [mm, vv=00, 00] is -100 cents, and 16383 [mm, vv=7F, 7F] is +99 cents.

Note: You can use the universal exclusive Fine Tune message to adjust the overall tuning, corresponding to the Global **Master Tune** parameter. For more information, see “About system exclusive messages” on page 936.

Transposing

RPN coarse tune [Bn, 65, 00, 64, 02]

This RPN message adjusts the transposition for Programs, Combination Timbres, and Sequencer Tracks.

The procedure is as follows.

1. [Bn, 65, 00, 64, 02]: Select RPN parameter 02.
2. [Bn, 06, mm, 26, vv]: Use data entry to set the value. Normally only the upper byte is used.

A value of 8192 [mm, vv=40, 00] is center, 6656 [mm, vv=34, 00] is -12 semitones, and 9728 [mm, vv=4C, 00] is +12 semitones.

Note: You can use the universal exclusive Coarse Tune message to adjust the overall tuning, corresponding to the Global **Transpose** parameter. For more information, see “About system exclusive messages” on page 936.

Changing the pitch bend range

RPN pitch bend range [Bn, 64, 00, 65, 00]

This RPN message adjusts the pitch bend range for Programs, Combination Timbres, and Sequencer Tracks.

The procedure is as follows.

1. [Bn, 65, 00, 64, 00]: Select RPN parameter 00.
2. [Bn, 06, mm, 26, vv]: Use data entry to set the value. Normally only the upper byte is used.

A value of 0 [mm, vv=00, 00] is +00, and a value of 1536 [mm, vv=0C, 00] is +12 (one octave). Although it is possible to set a negative value for a timbre/track, only positive values can be set using RPN messages.

About system exclusive messages

Since the way in which these messages are used is left up to each manufacturer, they are mainly used to transmit and receive sound data and editing data for parameters that are unique to a particular instrument. The NAUTILUS’s system exclusive message format is [F0, 42, 3n, DD, ff, F7]

F0: exclusive status

42: Korg ID

3n: [n=0–F] global MIDI channel 1–16

DD: NAUTILUS model ID

ff: function ID (type of message)

:

:

F7: end of exclusive

Note: To obtain a copy of the “MIDI Implementation” which includes MIDI System Exclusive format information, please contact your Korg distributor.

Universal system exclusive

Certain of the system exclusive messages are publicly defined for a specific use, and these are called universal system exclusive messages.

The NAUTILUS uses the following six universal system exclusive messages.

Inquiry message request [F0, 7E, nn, 06, 01, F7]

Inquiry message [F0, 7E, nn, 06, 02, (nine bytes), F7]

When an inquiry message request is received, the NAUTILUS will respond by transmitting an inquiry message that means “I am a Korg NAUTILUS, with system version ...”

GM system on [F0, 7E, nn, 09, 01, F7]

When this message is received in SEQUENCER mode, the NAUTILUS will be initialized for GM playback.

Master volume [F0, 7F, nn, 04, 01, vv, mm, F7]

(vv: lower byte of the value, mm: upper byte of the value, together indicating 16384 steps)

This message is transmitted if you assign Master Volume as the function of the ASSIGNABLE PEDAL or as a RT control knobs and operate the controller. This will adjust the overall volume balance without changing the relative volume balance between timbres/tracks. When this message is received, the result will be the same as when the controller is operated.

Master balance [F0, 7F, nn, 04, 02, vv, mm, F7]

(vv: lower byte of the value, mm: upper byte of the value, together indicating 16384 steps, where 8192 is the default position, and lower values will move the sound toward the left)

When this is received, the overall panning will be adjusted without changing the relative panning between timbres/tracks.

Master fine tuning [F0, 7F, nn, 04, 03, vv, mm, F7]

(A value of 8192 [mm, vv=40, 00] is center, 4096 [mm, vv=20, 00] is -50 cents, and 12288 [mm, vv=60, 00] is +50 cents.)

When this is received, the “Master Tune” (GLOBAL 0–1a) parameter will be set.

Master coarse tuning [F0, 7F, nn, 04, 04, vv, mm, F7]
(Normally only the upper byte mm is used. A value of 8192 [mm, vv=40, 00] is center, 6656 [mm, vv=34, 00] is -12 semitones, and 9728 [mm, vv=4C, 00] is +12 semitones.)

When this is received, the **Key Transpose** (GLOBAL 0-1a) parameter will be set.

Transmitting sound settings data (Data Dump)

Data for programs, combinations, drum kits, wave sequences, global settings, and sequencer data can be transmitted as MIDI System Exclusive messages. The operation of sending this system exclusive data to an external device is called a “data dump.”

By performing a data dump, you can store the NAUTILUS’s sounds and settings on an external device, or rewrite the sounds and settings of another NAUTILUS.

There are the following two types of data dump.

- When you use the “Dump–” (GLOBAL > MIDI page) page menu command to dump data, various types of internal memory data will be transmitted. If this data is received by the NAUTILUS, the data will be written directly into internal memory, and it will not be necessary to perform the Write operation.
- If the “Enable Exclusive” (GLOBAL 1-1c) setting is checked, data will also be dumped in response to a Dump Request message. This data is transmitted and received on the global MIDI channel.

When the NAUTILUS receives this data, the data will be written into the edit buffer. If you want to save the data into internal memory, you’ll have to execute the Write operation. This can be done either by executing the Write operation on the NAUTILUS itself, or by a MIDI System Exclusive program write request, combination write request, drum kit write request, wave sequence write request, or global setting write request.

Editing sounds via SysEx

By using various MIDI System Exclusive data dumps, you can rewrite all programs or an individual program. By using parameter change messages, you can edit individual parameters as follows.

Parameter changes

- In PROGRAM mode, all parameters other than the program name can be edited.
- In COMBINATION mode, parameters other than the combination name can be edited.
- In SEQUENCER mode, you can edit the track parameters in Play/Rec page, EQ/X-Y/Controllers page, Track Param page, IFX page, MFX/TFX page., and the ARP, Insert Effect, and Master/Total Effect parameters.

Drum kit parameter change/Wave sequence parameter change

In GLOBAL mode, you can edit drum kits and wave sequences.

Since the other global parameters or SEQUENCER mode musical data cannot be edited, you will use data dumps to transfer this data.

Data dumping of SAMPLING mode data is not supported.

The global MIDI channel is used to transmit and receive this data.

First check the “Enable Exclusive” (GLOBAL 1-1c) setting to enable transmission and reception of exclusive data.

When you switch modes on the NAUTILUS, a mode change will be transmitted. When you edit individual parameters, parameter change messages will be transmitted.

When these messages are received, the same editing operation will be performed as on the transmitted device.

Cautions regarding data dumps and sound editing

- After MIDI System Exclusive data has been received and processed, a Data Load Completed message will be transmitted. The control master device must not transmit the next message until this message is received (or until a sufficient interval of time has elapsed).
- When you change use parameter changes to edit, the changes will affect the data in the edit buffer and will not be stored in internal memory unless you Write, so that the changes will be lost if you re-select the program or combination. The Write operation can be performed by a MIDI System Exclusive Program Write Request or Combination Write Request message, in addition to the usual method of using the NAUTILUS’s switches. For more information, see “Loading & saving data” on page 203 of the OG.
- It is not necessary to write a song, but it will not be backed up when the power is turned off. If you want to keep the song data, you must save it to the internal drive or other media before powering off. “Saving to internal drive, CDs, and USB media” on page 209 of the OG.

If notes are “stuck”

If for some reason, notes become “stuck” and will not stop sounding, you can silence them by doing the following:

1. **Select a different sound, including any Program, Combination, Song, or Set List Slot.**
2. **Select a different sound again.**

For instance, within a Set List with Slot 1 selected, select Slot 2 and then return to Slot 1. Or, on Program A000, press the front-panel **COMBI** button (which selects a Combination) and then press the front-panel **PROG** button (to re-select the previous Program). At the second change, all notes held from the original sound will be stolen.

If notes played via MIDI are stuck, you can also disconnect the MIDI cable.

MIDI transmits a message called Active Sensing [FE] at regular intervals. A device that receives this message will be aware that an external MIDI device is transmitting to it. Subsequently, if no MIDI messages are received for a certain interval of time, the receiving device will decide that the connection has been broken, and will turn off any notes that had been sounded via MIDI and reset its controller values.

Playing the NAUTILUS multi-timbrally from an external device

The NAUTILUS can be connected to an external device and played multi-timbrally in the following ways.

- MIDI messages from the external device can play a combination (16-part multi-timbral performance). You can change the overall settings (programs, levels, and effects) by using program change messages to switch combinations.
- MIDI messages from the external device can be used to play a song (16-part multi-timbral performance). Overall settings (programs, levels, effects etc.) can be changed by using a Song Select message to switch songs. (Song Select messages can be received if **MIDI Clock**: Global 1–1a is set to External MIDI.)
- MIDI Clock messages from the external device can be used to make the NAUTILUS playback a song (set **MIDI Clock** to External MIDI, and run the NAUTILUS’s sequencer). (“Synchronizing the playback of arpeggiator or sequencer”) You can change the overall settings (programs, levels, effects) by using song select messages to switch songs.

Synchronizing the playback of arpeggiator or sequencer

The choice of whether the NAUTILUS will be the master (the controlling device) or the slave (the controlled device) is made by **MIDI Clock** (GLOBAL 1–1a).

Note: When MIDI Clock is set to Auto, the NAUTILUS will normally operate in the same way as for the Internal setting. When an external MIDI clock is received from the MIDI IN connector, the NAUTILUS will automatically operate as for the External MIDI setting.

Using the NAUTILUS as master and the external MIDI device as slave

Connect the NAUTILUS’s MIDI OUT connector to the MIDI IN connector of the external MIDI device.

- When you set **MIDI Clock** to Internal, the NAUTILUS will be the master device, and will transmit MIDI timing clock messages.

Arpeggiator function: The tempo can be controlled from the NAUTILUS. At the same time, the performance generated by Arpeggiator will be transmitted via MIDI. (In COMBINATION, and SEQUENCER modes, data will be transmitted by timbres/MIDI tracks whose **Status** is Both, EXT, or EX2.) An external tone generator connected to MIDI OUT will sound, and the tempo of an external sequencer can be controlled.

Sequencer: The musical data can be played back and controlled on the NAUTILUS.

Simultaneously, the sequencer playback will be transmitted via MIDI from MIDI tracks whose **Status** is Both, EXT, or EX2. An external tone generator connected to MIDI OUT will sound, and the tempo of an external sequencer can be controlled.

Using the external MIDI device as master and the NAUTILUS as slave

Connect the NAUTILUS’s MIDI IN connector to the MIDI OUT connector of the external MIDI device.

- When you set **MIDI Clock** to External MIDI, the NAUTILUS will be the slave device.

Arpeggiator: The tempo will follow the MIDI clock. If you play the external sequencer, the Arpeggiator will synchronize to the external clock.

Even if **MIDI Clock** is External MIDI and the NAUTILUS is being controlled from the external device, the performance of Arpeggiator will still be transmitted via MIDI. (In COMBINATION and SEQUENCER modes, Arpeggiator will be transmitted from timbres/MIDI tracks whose **Status** is Both, EXT, or EX2.)

Sequencer: It will not be possible to control the playback from the NAUTILUS; instead, playback will be controlled by the external device. If you wish to play the external sequencer in sync with the NAUTILUS’s sequencer, you must first set the same time signature and starting measure locations on both devices.

Even if **MIDI Clock** is set to External MIDI and the NAUTILUS is being controlled from an external device, musical data will be transmitted by tracks whose **Status** is Both, EXT, or EX2.

Recording MIDI from an external sequencer

You can record the MIDI output of an external sequencer into the NAUTILUS using either synchronized or unsynchronized MIDI clocks. Each method has its benefits and caveats, as described below.

In either case, you will need to set up the NAUTILUS sequencer for multitrack recording. For more information, see “Multi (multitrack recording)” on page 81 of the OG.

Synchronized clocks

Generally, the best method is to synchronize the NAUTILUS to the external sequencer. To do this:

1. Set the Global MIDI Clock to External MIDI.

This lets the external sequencer control both the tempo and the point at which recording starts.

2. Set the NAUTILUS time signature to match that of the external sequencer.

3. Start recording on the NAUTILUS.

4. Start the external sequencer.

With **MIDI Clock** set to External MIDI, the NAUTILUS will start recording automatically as soon as the external sequencer starts playback.

Since the two devices are synchronized during the recording process, measure divisions etc. will be preserved accurately. Synchronization is also critical if you need to record in multiple passes, as opposed to all tracks at once.

The one drawback of this method is that any changes to tempo or time signature will not be recorded. If any of these are used, you will have to re-create them within the NAUTILUS sequencer after recording.

Un-synchronized clocks

If you need to record tempo changes in real-time, instead of re-creating them later, you can also record without synchronizing the clocks. To do this:

1. Set the Global MIDI Clock to Internal.
2. Start recording on the NAUTILUS.
3. Start the external sequencer.

This records incoming MIDI data exactly as it is received, preserving any tempo changes.

The drawback of this method is that data regarding measure divisions and rhythmic values will not be preserved. So, this method is not suitable if you intend to edit the data later.

Recording the MIDI output of the NAUTILUS's controllers, and internal sequencer to an external sequencer or computer

If you wish to record the MIDI output of the NAUTILUS's controllers function, and internal sequencer on an external sequencer or computer and use the NAUTILUS as the monitoring and playback tone generator while you record, you must turn off the NAUTILUS's Local Control setting ("Local Control On" Global 1-1a), and set your external sequencer/computer for echo-back (a function by which the data received at MIDI IN is retransmitted without change from MIDI OUT) so that the data from the NAUTILUS's controllers function and internal sequencer will not be applied in duplicate to the tone generator.

Using the RT control knobs 1-6 to record MIDI control changes on an external MIDI sequencer/computer

Set the NAUTILUS to Local Control Off. Set the external MIDI sequencer/computer to Echo Back On. With these settings, recording and playback will occur correctly, and the control changes will not be applied to the tone generator in duplicate.

Recording RPPR function on an external MIDI sequencer/computer

In SEQUENCER mode, when the RPPR function is on, playing the keyboard will cause RPPR to operate. Similarly, the RPPR function will also operate in response to notes received on the MIDI channel of the track selected by **Track Select** (SEQUENCER 0-1a). Notes will be transmitted by RPPR from MIDI OUT according to the local control setting ("Local Control On") as described below.

Local Control On: Notes from RPPR will be transmitted from MIDI OUT.

Local Control Off: Notes from RPPR will not be transmitted from MIDI OUT. The NAUTILUS will sound only in response to MIDI messages received at MIDI IN, or generated by RPPR.

Setting example 1

To record the note messages generated by Arpeggiator or RPPR on the external MIDI sequencer/computer:

1. Turn on Arpeggiator or RPPR.

2. On GLOBAL > MIDI, enable Local Control On.

3. Make the following ARP External Routing settings (GLOBAL 1-1b).

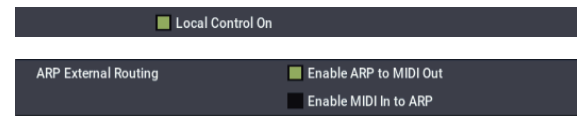

4. On your external sequencer or computer, turn the echo back setting Off.

When you're recording a performance generated by Arpeggiator or RPPR, this setting will prevent duplicate notes from being sounded by the echo-back. (Turn the RPPR function off for playback.)

Setting example 2

To use the external MIDI sequencer/computer to record only the notes that trigger Arpeggiator or RPPR, and operate ARP or RPPR for monitoring while recording, and during playback:

1. Turn on Arpeggiator or RPPR.
2. On GLOBAL > MIDI, disable Local Control On.
3. Make the following ARP External Routing settings (GLOBAL 1-1b).

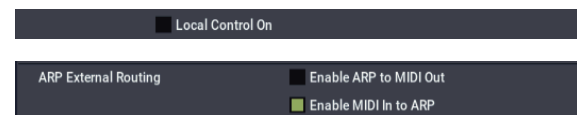

Notes generated by Arpeggiator or RPPR will not be output.

4. On your external MIDI sequencer or computer, turn on the echo back setting.

This allows recording to occur correctly, without ARP or the RPPR function being applied in duplicate.

About GM (General MIDI)

The NAUTILUS supports the GM standard. It also supports the GM2 sound map (including bank select) with 256 programs and 9 drum programs provided in ROM banks G, g(1)-g(9), and g(d). (Banks g(1)-g(9) are GM2 variation programs, and g(d) contains drum programs.)

GM is a standard that ensures basic compatibility of sounds and controllers between GM-compatible instruments made by different manufacturers. When using GM with NAUTILUS, be aware of the following.

- GM System On is supported in SEQUENCER mode. For more information, see "GM Initialize" on page 523.
- When you wish to play a GM sequence, or load GM data into a song, set "Bank Map" (GLOBAL 0-1d) to GM(2).

About standard MIDI files

Standard MIDI files (SMF) make it possible for different computer programs or musical instruments made by different manufacturers to exchange time-based MIDI data. Each standard MIDI file contains one song. The NAUTILUS supports format 0 (type 0) in which all of the MIDI data is combined into one track, and format 1 (type 1) in which the data is separated by track.

When a SMF is loaded into a song in MEDIA mode, the program bank that is selected will differ depending on the “Bank Map” (GLOBAL 0–1d) setting. When playing/loading SMF data that conforms to the GM specifications, set “Bank Map” to GM(2).

SEQUENCER mode

In MEDIA mode when you convert a song into a Standard MIDI File and save it, you can choose either format 0 or format 1.

- If NAUTILUS song data that was saved as a format 1 SMF file is loaded into another device, the track configuration may be different than it was before being saved. This is because MIDI tracks that contain no musical data are omitted, and the remaining tracks are moved into the unused tracks. This will not affect the playback itself.
- If song data that was saved by another device as a format 1 SMF file is loaded into the NAUTILUS, the track configuration may be different than it was before being saved. This is because tracks that contain no musical data are omitted, and the remaining tracks are moved into the unused tracks. This will not affect the playback itself.

When exchanging sequence data between two NAUTILUS, we recommend that you save the sequence data in the NAUTILUS’s native format (“Save SEQ”).

When sequence data is saved in the NAUTILUS’s native format, all of the settings and patterns unique to the NAUTILUS will be saved, which will ensure a higher level of reproducibility than when the data is saved as a Standard MIDI File (“Save to Standard MIDI File”).

Parameter changes and other recorded data is included in the song data as System Exclusive events, so it can be saved to or loaded from drive as usual. Exclusive messages can also be loaded or saved as SMF (Standard MIDI File) data (“Load Standard MIDI File,” “Save Song as Standard MIDI File”). This allows recorded System Exclusive events to be saved as SMF data, or exclusive messages included in SMF data to be converted into song data.

During playback, this data can be transmitted to an external MIDI device, or used to control track parameters or effect parameters of the song.

MEDIA mode and file format information

AIFF and WAVE format details: importing

AIFF files

When data is loaded into the NAUTILUS, the following four chunks are referenced: Common chunk, Sound Data chunk, Marker chunk, and Instrument chunk. Other chunks are ignored.

Restrictions on the parameters in each chunk are described below.

Common chunk

Only one (mono) or two (stereo) channels are supported. Sample sizes of 1–24 bits are supported.

If the sample data is 8 bits or less, it will be loaded as 16 bit data with the lower 8 bits always at 0.

Sound Data chunk

Offset and block size are ignored. (Block-Aligning Sound Data is not supported.)

Marker chunk

Up to eight markers are supported. The ninth and subsequent markers will be ignored.

Instrument chunk

If the loop play mode is ForwardBackwardLooping, this will be handled as ForwardLooping. baseNote, detune, lowNote, highNote, lowVelocity, highVelocity, gain, and releaseLoop will be ignored.

WAVE files

When loading, the NAUTILUS references the Format Chunk, Sample Chunk, and Wave Data. Limitations are discussed below.

Format chunk

Standard PCM format is the only format category that is supported.

Only one (mono) or two (stereo) channels are supported.

Sample sizes of 1–24 bits are supported. If the sample data is 8 bits or less, it will be loaded as 16 bit data with the lower 8 bits always at 0.

Sample Chunk

Only the loop data is referenced. If there is multiple loop data, the loop with the greatest number of loop playback times (Play Count) will be used. Even if the Type is Alternating or Backward, it will be handled as Forward Loop.

Wave data

The Wave List chunk is not supported.

AIFF and WAVE format details: exporting

AIFF files

When exporting, the NAUTILUS will use the Common Chunk, Sound Data Chunk, Marker Chunk, and Instrument Chunk.

Limitations on the parameters within each chunk are discussed below.

Common Chunk

The number of channels is fixed at 1 (mono).

The sample size is fixed at 16 bits.

Marker Chunk

Two markers are used as Loop Start Address and End Address respectively.

Instrument Chunk

The loop play mode is fixed at Forward Looping.

Zone data of the multisamples will not be exported.

Format Chunk

The format category is fixed at standard PCM format.

The number of channels is 1 (mono) or 2 (stereo), and is fixed at 1 (mono) for export.

16- and 24-bit sample sizes are supported.

Sample Chunk

The Type is fixed at Forward Loop.

Zone data of the multisamples will not be exported.

WAVE files

When exporting, the NAUTILUS will use the Format Chunk, Sample Chunk, and Wave Data. Restrictions are given below.

Korg format sample files

Korg format file structure

There are three types of sample-related Korg-format files: .KMP files for multisamples, .KSF files for samples, and .KSC files which handle the first two as a collection. Similar to the AIFF format, .KMP/.KSF files consist of chunks.

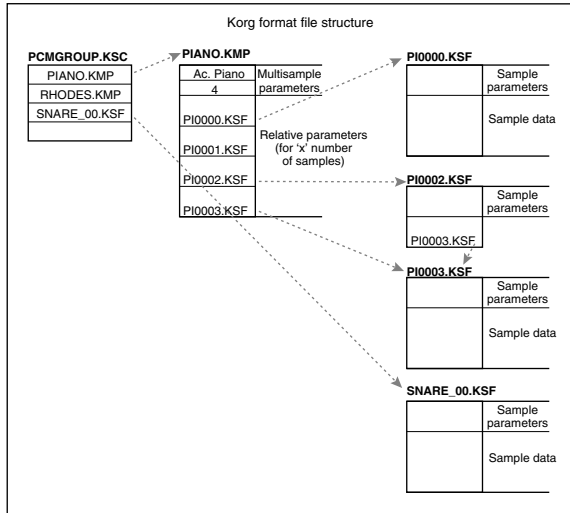

Unless stated otherwise, all data is Big Endian.

TRINITY Compatibility

Loading NAUTILUS multisamples into the TRINITY

When loading NAUTILUS multisamples into the TRINITY, the following parameters are ignored:

- RLP1 chunk: **Filter cutoff**
- RLP2 chunk: **Transpose, Resonance, Attack, and Decay**
- RLP3 chunk: **Drive, Boost, LowEQLevel, MidEQLevel, and HighEQLevel**

Loading NAUTILUS samples into the TRINITY

- The **Reverse Playback** and **Loop Off** settings (included in the attribute parameters of the SMD1 chunk) will be ignored, and will be handled respectively as forward playback and loop on.
- The **+12dB** setting is ignored.
- Split sample files cannot be loaded.
- The NAUTILUS supports a broader range of sampling frequencies than the TRINITY. If the sampling frequency is not supported by the TRINITY, the next-lowest frequency will be selected.

Loading TRINITY files into the NAUTILUS

When a Korg format file saved on the TRINITY is loaded into the NAUTILUS:

- Compressed sample files cannot be loaded.
- Multisamples that use internal samples of the Trinity will be assigned to identically-numbered samples in SAMPLING mode.

TRITON Compatibility

Loading NAUTILUS multisamples into the TRITON

When loading a NAUTILUS .KMP file into the TRITON, the following parameters are ignored: **Drive, Boost, LowEQLevel, MidEQLevel, and HighEQLevel**. All of these parameters are in the RLP3 chunk.

Loading NAUTILUS samples into the TRITON

- The **+12dB** setting is supported by the TRITON STUDIO and TRITON EXTREME, but not by the TRITON, TRITON-Rack, or TRITON Le.
- The NAUTILUS supports a broader range of sampling frequencies than the TRITON. If the sampling frequency is not supported by the TRITON, the next-lowest frequency will be selected.

KMP (Korg Multisample Parameter) files

These consist of the following chunks.

- Multisample parameter chunk

| | |
|--------------------------------------|------------|
| Chunk ID ('MSP1') | [4 bytes] |
| Chunk size (fixed at 18) | [4 bytes] |
| Multisample name | [16 bytes] |
| Number of samples in the multisample | [1 byte] |
| Attributes | [1 byte] |

- Attributes

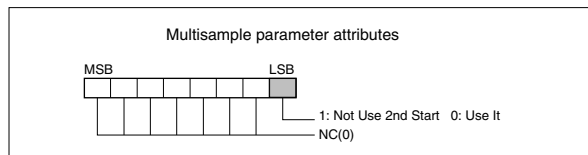

- Multisample name chunk

| | |
|--------------------------|------------|
| Chunk ID ('NAME') | [4 bytes] |
| Chunk size (fixed at 24) | [4 bytes] |
| Multisample name | [24 bytes] |

- Relative parameter chunk 1

| | |
|--|------------|
| Chunk ID ('RLP1') | [4 bytes] |
| Chunk size (18 × number of samples in the multisample) | [4 bytes] |
| Original key | [1 byte] |
| MSB 1: Non Transpose 0: Transpose | |
| bits 6–0 original key | |
| Top key (0–127) | [1 byte] |
| Tune (–99...+99 cents) | [1 byte] |
| Level (–99...+99 cents) | [1 byte] |
| Pan (0–127 currently unused) | [1 byte] |
| Filter cutoff (–99...+99 currently unused) | [1 byte] |
| KSF filename (including period and extension) | [12 bytes] |

If the .KSF filename is "SKIPPEDSAMPL", it will be treated as a sample skipped during loading.

Legacy files may include .KSF filenames of "INTERNALnnnn," which designated internal samples on previous Korg instruments. On the NAUTILUS, this feature is not supported.

- Relative parameter chunk 2

| | |
|-------------------------|-----------|
| Chunk ID ('RLP2') | [4 bytes] |
| Chunk size (4) | [4 bytes] |
| Transposing (-64...+63) | [1 byte] |
| Resonance (-99...+99) | [1 byte] |
| Attack (-99...+99) | [1 byte] |
| Decay (-99...+99) | [1 byte] |

- Relative parameter chunk 3

| | |
|-------------------------|-----------|
| Chunk ID ('RLP3') | [4 bytes] |
| Chunk size (fixed at 6) | [4 bytes] |
| Drive (-99...+99) | [1 byte] |
| Boost (-99...+99) | [1 byte] |
| LowEQLevel (-99...+99) | [1 byte] |
| MidEQLevel (-99...+99) | [1 byte] |
| HighEQLevel (-99...+99) | [1 byte] |
| unused | [1 byte] |

- Multisample number chunk

| | |
|-------------------------|-----------|
| Chunk ID('MNO1') | [4 bytes] |
| Chunk size (4) | [4 bytes] |
| Multisample number (0-) | [4 bytes] |

KSF (Korg Sample File) files

There are four types of structure for these files. One consists of a Sample Parameter chunk, Sample Data chunk, Sample Number chunk and Sample name (SMP1 + SMD1 + SNO1 + NAME). Another consists of a Sample Parameter chunk, Sample Data chunk, Sample Filename chunk, Sample Number chunk, and Sample name chunk (SMP1 + SMD1 + SMF1 + SNO1 + NAME). The latter structure is in the case where the sample data of the Sample chunk is empty, and uses the sample data of the .KSF file specified by the Sample Filename chunk (shared sample data).

- Sample parameter chunk

| | |
|--------------------|------------|
| Chunk ID ('SMP1') | [4 bytes] |
| Chunk size (32) | [4 bytes] |
| Sample name | [16 bytes] |
| Start address | [4 bytes] |
| 2nd start address | [4 bytes] |
| Loop start address | [4 bytes] |
| Loop end address | [4 bytes] |

- Sample data chunk

| | |
|--|-----------|
| Chunk ID ('SMD1') | [4 bytes] |
| Chunk size (12 + number of sample databytes) | [4 bytes] |
| Sampling frequency | [4 bytes] |

| | |
|-----------------------------|-----------|
| Attributes | [1 byte] |
| Loop tune (-99...+99 cents) | [1 byte] |
| Number of channels (1) | [1 byte] |
| Sample size (8/16) | [1 byte] |
| Number of samples | [4 bytes] |

| | |
|-------------|-----------------|
| Sample data | variable length |
|-------------|-----------------|

Sampling frequency is a 4-byte unsigned integer; all frequencies between 0Hz and 4.294GHz are supported. When sampling frequency is greater than 48kHz, if the data includes audio frequencies above 24kHz, playback quality may be slightly degraded.

- Attributes

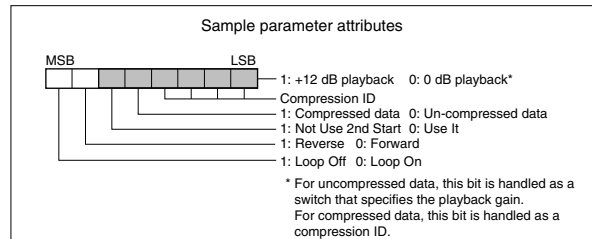

- Sample number chunk

| | |
|--------------------|-----------|
| Chunk ID ('SNO1') | [4 bytes] |
| Chunk size (4) | [4 bytes] |
| Sample number (0-) | [4 bytes] |

- Sample name chunk

| | |
|--------------------------|------------|
| Chunk ID ('NAME') | [4 bytes] |
| Chunk size (fixed at 24) | [4 bytes] |
| Sample name | [24 bytes] |

- Sample filename chunk

| | |
|-------------------|------------|
| Chunk ID ('SMF1') | [4 bytes] |
| Chunk size (12) | [4 bytes] |
| KSF filename | [12 bytes] |

If the .KSF filename is "SKIPPEDSAMPL", it will be treated as a sample skipped during loading.

If the .KSF filename is "INTERNALnnnn", internal samples will be used.

- Divided sample parameter chunk

| | |
|--|-----------|
| Chunk ID ('SPD1') | [4 bytes] |
| Chunk size (12) | [4 bytes] |
| The following up to the sample size is the same as in the SMD1 chunk | |
| Sampling frequency | [4 bytes] |
| Attributes | [1 byte] |
| Loop tune | [1 byte] |
| Number of channels | [1 byte] |
| Sample size | [1 byte] |
| Number of samples | [4 bytes] |
| Total number of samples in all divided files | |

- Divided sample data chunk

| | |
|---|-----------|
| Chunk ID ('SDD1') | [4 bytes] |
| Chunk size (4 + number of sample databytes) | [4 bytes] |
| Random ID | [2 bytes] |
| File Number | [2 bytes] |
| PCM data bytes | |

KSC (Korg Sample Collection) files

KSC files group together any set of SAMPLING mode Samples and Multisamples (.KMP and .KSF files) and/or any set of links to EXs or User Sample Bank Multisamples and Drum Samples. This lets you load all of the sample data with a single command, or automatically load the data at startup.

When you save a KSC which includes SAMPLING mode data, two KSC files are created:

- A KSC with the name you've specified, which includes the actual Samples and Multisamples from SAMPLING mode.
- A second KSC which includes links to the first KSC's SAMPLING mode Data, with Load Method set to Virtual Memory. The name for this KSC is the name you've specified followed by the text UserBank. For instance, if the first KSC is named BillGig.KSC, the second will be BillGig_UserBank.KSC. This is the file that you'll load to access the sample data as a User Sample Bank.

Both files may contain references to other EXs or User Sample Banks, depending on the setting of the Include parameter in the Save dialog.

KSC files have been used in previous Korg products, including the TRITON and OASYS. These products used the KSC 1.0 format, while the NAUTILUS uses a the new, expanded KSC 2.0 format. A further set of extensions are added in NAUTILUS 2.0 to support User Sample Banks. These extensions will be ignored by versions prior to NAUTILUS 2.0.

For compatibility purposes, the KSC 2.0 format begins with the same first line as the KSC 1.0 format:

```
#Korg Script Version 1.0
```

A version 2 file is indicated if the second line is:

```
#v2
```

In NAUTILUS 2.0+, KSCs which contain SAMPLING mode data include a UUID (universally unique identifier):

```
#uuid:2b4b0aa0-4d31-11e1-b86c-0800200c9a66
```

This uuid line will be ignored on versions prior to NAUTILUS 2.0. Files which contain only links to EXs and/or User Sample Banks will not include a UUID.

Programs, Wave Sequences, Drum Kits, and other KSCs link to the SAMPLING mode data as a User Sample Bank via this UUID.

Following the UUID (if present) is the list of any SAMPLING mode data Samples or Multisamples (KMP/KSF filenames). This part of the data is comparable with KSC 1.0 devices. For more information, see "KSC 1.0 format" on page 947. This information is repeated in the 2.0 data.

After the list of .KMP and .KSF files, the 2.0 data is embedded in comments, as follows:

1. #>User.A.B.FILENAME

"#>User" indicates a reference to a user Sample/Multisample.

A and B are reserved for future use.

FILENAME is the name of the KMP/KSF.

2. #>EXSN.TTI.V.B.NAME

"#>EXS" indicates a reference to an EXs Multisample/Drum Sample.

N is the EXs bank number, counting from 0. Note that this is offset by one from the user-viewable numbers, so for instance EXs0 = EXs1 ROM Expansion.

Important: the maximum EXs# representable in this syntax is 125. EXs banks > 125 will be referred to by UUID as in #3 below.

TT indicates whether the entry is a Multisample or Drum Sample (MS = Multisample, DS = Drum Sample).

V indicates whether playback is from Virtual Memory or RAM (0 = RAM, 1 = Virtual Memory).

B is reserved for future use.

NAME is the Multisample/Drum Sample name.

3. #>>uuid:U.TTI.V.B.NAME

This is the more generalized of #2 above, which is a link to an EXs bank or user bank Multisample or Drum Sample.

U is the 36-character UUID for the referenced bank. TT, V, B, and NAME are the same as in #2.

Lines of this type will be ignored in versions prior to NAUTILUS 2.0. For this reason, references to EXs0...EXs125 are still written in the #2 style, for backwards compatibility.

4. #>BankN.M.D.Name

"#>Bank" is a line containing information about an EXs bank.

N is the EXs bank number, counting from 0. Note that this is offset by one from the user-viewable numbers, so for instance EXs0 = EXs1 ROM Expansion.

Important: the maximum EXs# representable in this syntax is 125. EXs banks > 125 will be referred to by UUID as in #5 below.

M is the number of Multisamples in the bank.

D is the number of Drum Samples in the bank.

Name is the name of the bank.

5. #>>uuid:U.M.D.NAME

This is the more generalized version in of #4 above, which is description of an EXs bank or user bank. It is used and recognized only by NAUTILUS software versions 2.0 and higher.

U is the 36-character UUID for the referenced bank. M, D, and NAME are the same as in #4.

Lines of this type will be ignored in versions prior to NAUTILUS 2.0. For this reason, references to EXs0...EXs125 are still written in the #4 style, for backwards compatibility.

Example file 1

Here's a simple pair of KSC files. Somethings.KSC contains some SAMPLING mode data, and so when saving the system also creates Somethings_UserBank.KSC.

```
The file Somethings.KSC:
#KORG Script Version 1.0
#v2
#uuid:5a27d1e1-63c7-4d32-92fa-f6bc95ee6ee6
DOODL000.KMP
DOODL001.KMP
SOMET006.KMP
SOMET007.KMP
SWEEP010.KMP
SWEEP011.KMP
POLY0002.KSF
POLY0003.KSF
BASS0006.KSF
BASS0007.KSF
#>User.0.2.DOODL000.KMP
#>User.0.2.DOODL001.KMP
#>User.0.2.SOMET006.KMP
#>User.0.2.SOMET007.KMP
#>User.0.2.SWEEP010.KMP
#>User.0.2.SWEEP011.KMP
#>User.0.2.POLY0002.KSF
#>User.0.2.POLY0003.KSF
#>User.0.2.BASS0006.KSF
#>User.0.2.BASS0007.KSF
```

And the associated file Somethings_UserBank.KSC.

```
#KORG Script Version 1.0
#v2
#>>uuid:5a27d1e1-63c7-4d32-92fa-f6bc95ee6ee6.MS0.1.0.DOODLE -L
#>>uuid:5a27d1e1-63c7-4d32-92fa-f6bc95ee6ee6.MS1.1.0.DOODLE -R
#>>uuid:5a27d1e1-63c7-4d32-92fa-f6bc95ee6ee6.MS6.1.0.SOMETHING -L
#>>uuid:5a27d1e1-63c7-4d32-92fa-f6bc95ee6ee6.MS7.1.0.SOMETHING -R
#>>uuid:5a27d1e1-63c7-4d32-92fa-f6bc95ee6ee6.MS10.1.0.SWEEPS -L
#>>uuid:5a27d1e1-63c7-4d32-92fa-f6bc95ee6ee6.MS11.1.0.SWEEPS -R
#>>uuid:5a27d1e1-63c7-4d32-92fa-f6bc95ee6ee6.DS0.1.0.Noodles -L
#>>uuid:5a27d1e1-63c7-4d32-92fa-f6bc95ee6ee6.DS1.1.0.Noodles -R
#>>uuid:5a27d1e1-63c7-4d32-92fa-f6bc95ee6ee6.DS2.1.0.poly6 -L
#>>uuid:5a27d1e1-63c7-4d32-92fa-f6bc95ee6ee6.DS3.1.0.poly6 -R
#>>uuid:5a27d1e1-63c7-4d32-92fa-f6bc95ee6ee6.DS4.1.0.SWEEPS -L
#>>uuid:5a27d1e1-63c7-4d32-92fa-f6bc95ee6ee6.DS5.1.0.SWEEPS -R
#>>uuid:5a27d1e1-63c7-4d32-92fa-f6bc95ee6ee6.DS6.1.0.bass riff -L
#>>uuid:5a27d1e1-63c7-4d32-92fa-f6bc95ee6ee6.DS7.1.0.bass riff -R
#>>uuid:5a27d1e1-63c7-4d32-92fa-f6bc95ee6ee6.DS8.1.0.BASS2 -L
#>>uuid:5a27d1e1-63c7-4d32-92fa-f6bc95ee6ee6.DS9.1.0.BASS2 -R
#>>uuid:5a27d1e1-63c7-4d32-92fa-f6bc95ee6ee6.DS10.1.0.Strum -L
#>>uuid:5a27d1e1-63c7-4d32-92fa-f6bc95ee6ee6.DS11.1.0.Strum -R
#>uuid:5a27d1e1-63c7-4d32-92fa-f6bc95ee6ee6.12.12.Somethings
```

Example file 2

Here's a more complicated example. MyCollection.KSC and the associated MyCollection_UserBank.KSC contain both SAMPLING mode data and references to other data, including references to MS/DS from EXs1 and references to samples in a User Sample Banks called OtherThings.

The file MyCollection.KSC:

```
#Korg Script Version 1.0
#v2
#uuid:c8ea3f90-6f2a-11e1-b0c4-0800200c9a66
NEWMS000.KMP
NEWMS001.KMP
NEWMS002.KMP
TICK0000.KSF
TOCK0001.KSF
TOCK0002.KSF
#>User.0.0.NEWMS000.KMP
#>User.0.0.NEWMS001.KMP
#>User.0.0.NEWMS002.KMP
#>User.0.0.TICK0000.KSF
#>User.0.0.TOCK0001.KSF
#>User.0.0.TOCK0002.KSF
#>EXS0.MS0.1.0.Acoustic Piano 1 mp -L
#>EXS0.MS1.0.0.Acoustic Piano 1 mp -R
#>EXS0.MS2.0.0.Acoustic Piano 1 mp-mono
#>EXS0.MS3.0.0.Acoustic Piano 2 mf -L
#>EXS0.MS4.0.0.Acoustic Piano 2 mf -R
#>Bank0.229.1483.ROM Expansion
#>>uuid:fe6ee590-68b7-11e1-b86c-0800200c9a66.MS0.1.0.ACID -L
#>>uuid:fe6ee590-68b7-11e1-b86c-0800200c9a66.MS1.1.0.ACID -R
#>>uuid:fe6ee590-68b7-11e1-b86c-0800200c9a66.MS2.1.0.MONKEY MONO
#>>uuid:fe6ee590-68b7-11e1-b86c-0800200c9a66.DS0.1.0.MONKEYS
#>uuid:fe6ee590-68b7-11e1-b86c-0800200c9a66.3.1.Otherthings
```

And the associated file MyCollection_UserBank.KSC:

```
#Korg Script Version 1.0
#v2
#>>uuid:c8ea3f90-6f2a-11e1-b0c4-0800200c9a66.MS0.1.0.Flute
#>>uuid:c8ea3f90-6f2a-11e1-b0c4-0800200c9a66.MS1.1.0.Violin
#>>uuid:c8ea3f90-6f2a-11e1-b0c4-0800200c9a66.MS2.1.0.Sirens
#>>uuid:c8ea3f90-6f2a-11e1-b0c4-0800200c9a66.DS0.1.0.Tick
#>>uuid:c8ea3f90-6f2a-11e1-b0c4-0800200c9a66.DS1.1.0.Tock 1
#>>uuid:c8ea3f90-6f2a-11e1-b0c4-0800200c9a66.DS2.1.0.Tock 2
#>uuid:c8ea3f90-6f2a-11e1-b0c4-0800200c9a66 .3.3.MyCollection
#>EXS0.MS0.1.0.Acoustic Piano 1 mp -L
#>EXS0.MS1.0.0.Acoustic Piano 1 mp -R
#>EXS0.MS2.0.0.Acoustic Piano 1 mp-mono
#>EXS0.MS3.0.0.Acoustic Piano 2 mf -L
#>EXS0.MS4.0.0.Acoustic Piano 2 mf -R
#>Bank0.229.1483.ROM Expansion
#>>uuid:fe6ee590-68b7-11e1-b86c-0800200c9a66.MS0.1.0.ACID -L
#>>uuid:fe6ee590-68b7-11e1-b86c-0800200c9a66.MS1.1.0.ACID -R
#>>uuid:fe6ee590-68b7-11e1-b86c-0800200c9a66.MS2.1.0.MONKEY MONO
#>>uuid:fe6ee590-68b7-11e1-b86c-0800200c9a66.DS0.1.0.MONKEYS
#>uuid:fe6ee590-68b7-11e1-b86c-0800200c9a66.3.1.Otherthings
```

KSC 1.0 format

Lines beginning with # are ignored as comment lines, with the notable exception of version 2.0 data.

The first line of the file must begin with “#Korg Script Version 1.0” and subsequent lines (except for comment lines) consist only of filenames. Only files with an extension of KMP/KSF are processed.

Filename conventions

.KMP filename for **Save All** or **Save All Multisamples**

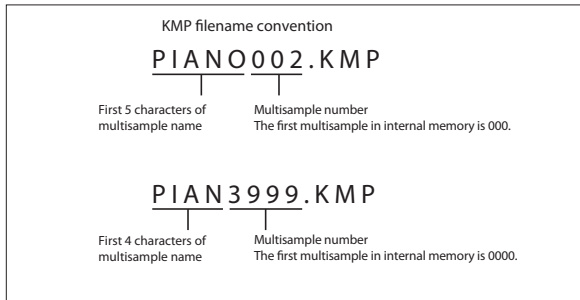

When data is saved using **Save All**, **Save All Multisample** or **Save One Multisample**, the individual .KSF files used by the Multisample (the .KMP file) are automatically given filenames according to the following convention.

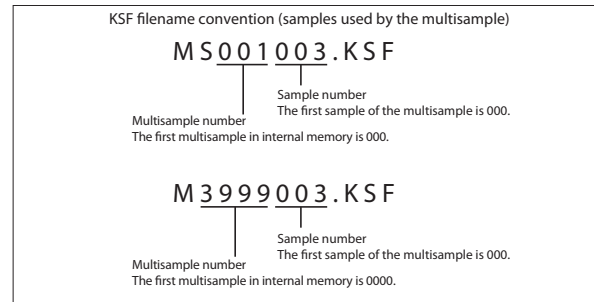

Likewise, when data is saved using **Save All** or **Save All Samples**, the individual .KSF files are automatically given filenames according to the following convention.

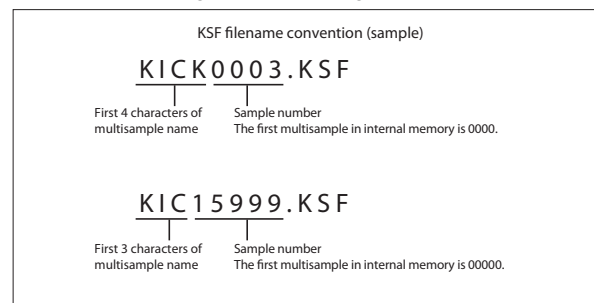

OASYS .SNG file compatibility

The NAUTILUS sequencer can load and play the OASYS song format, with the following caveats.

Preloaded sounds are different

The NAUTILUS’s preloaded Programs, Wave Sequences, Drum Kits, etc. are not the same as those of the OASYS. When loading a Song created on the OASYS, please also load the PCG file saved with the Song.

Audio file directory name

Before an OASYS Song with audio files can be played, the audio directory names must be edited slightly. OASYS files were limited to 8 characters, and so the name of the audio file directory was typically abbreviated. For instance, if the .SNG file was named WAMAZART.SNG, the OASYS audio folder would be named WAMOZA_A.

The NAUTILUS supports long file names, and expects to see the entire .SNG name in the audio folder name. Before you load an OASYS .SNG file, edit the name of the audio directory so that it matches the NAUTILUS standard: the same name as the .SNG file, followed by “_A” (for “Audio”). In the case above, you’d rename “WAMOZA_A” to “WAMAZART_A.”

Timing resolution

OASYS .SNG files have a timing resolution of 192 ppq (parts per quarter note). If these .SNG files are loaded into NAUTILUS or later, they will automatically be converted to 480 ppq.

In some cases, this conversion may mean that some MIDI events might not be at exactly the same timing (see illustration below). In this example, locations 1 and 3 of the 192 ppq data will be converted to locations 2 and 7 of the 480 ppq data.

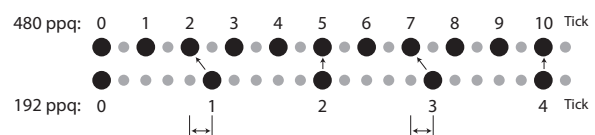

For audio tracks, the timing precision is improved by adjusting the region’s Start point as well as the timing of the audio event. This is because the relative timing of audio events is more critical, due to possible problems such as phasing.

For this reason, if MIDI events and audio data that start at location 1 of the 192 ppq data in this example were converted, the MIDI data would be placed at location 2 of the 480 ppq data, while the audio data would start between locations 2 and 3 of the 480 data (corresponding to location 1 of the 192 ppq data), causing a discrepancy.

At 40.00 bpm, one tick of 480 ppq corresponds to 2.125 ms. Thus at this slowest tempo available on the NAUTILUS (40 bpm), the MIDI event would shift 1.5625 ms forward relative to the 192 ppq timing, and the audio would play back at virtually the same timing; an approximately 0.02 ms resolution of the sample rate.

CD-R/RW disks on the NAUTILUS: UDF and packet-writing

In conjunction with an external USB CD-R/RW drive, the NAUTILUS lets you use CD-R/RW disks like you would a floppy disk or a removable hard disk. You can save individual files to a disk, over-write them, add new folders, and so on, without needing to “burn” an entire disk at once.

It does so by using UDF (Universal Disk Format) version 1.5 and packet writing, as described below, as its native CD-R/RW data format. Note that there are some considerations when reading these disks on computers or other equipment, as described under “Reading NAUTILUS CDs on other devices,” below.

About packet writing

Packet writing is a method of dividing data into small units, called “packets.” This makes it possible to write individual files to CD-R/RW disks, as opposed to writing an entire disk at once.

Compatible media

 Before writing data to a CD-R/RW disk, you must format the disk using the NAUTILUS.

CD-R media

- 650 MB and 700 MB CD-R media (up to 48× write speed)

CD-RW media

- 650 MB and 700 MB CD-RW media (up to 4×/10× write speeds)

Formatting

Before using CD-R/RW disks, you need to format them. To do so, insert the blank or previously-formatted media into the drive, go to the MEDIA– Utility page, and select the **Format** menu command.

Cautions when formatting

CD-R media

Quick Format takes less than a minute.

Full Format applies only to CD-RW media, and so it can’t be selected for CD-R disks.

Re-formatting: Data that has been written to CD-R cannot be erased as it can on a floppy disk. This means that re-formatting previously-formatted media will not increase the free space; instead, approximately 20 MB of space will be used to add a new session.

CD-RW media

Quick Format: Use this option to erase the contents of a previously formatted CD-RW. This cannot be used with blank CD-RW media. It takes about two minutes to complete.

Full Format: Use this option to format blank media, or media which has been formatted as a non-UDF disk.

You can also use **Full Format** if writing errors occur frequently when writing to the disk.

Full Format takes about fifteen minutes for 10x CD-RW media, and about thirty minutes for 4x CD-RW media. (Depending on the condition of the disk, it may take substantially longer.)

Formatting takes up some of the space on the disk, so that 650 MB/700 MB media will have approximately 530 MB/570 MB of available space, respectively.

Re-formatting: Like floppy disks and hard drives, CD-RW disks can be formatted to erase any previous contents, and re-formatting frees up space on the disk.

Deleting and updating files

CD-R media

With CD-R media, deleting a file merely hides it from view; the file still exists on the disk, and no space is freed by the deletion.

Similarly, when you save a new version of a file, the previous version is hidden but not actually removed from the disk. Each version of the file will take up additional space on the disk.

CD-RW media

CD-RW disks work the same way as hard drives. Deleting files frees up space on the disk, and saving a new version of a file (with the same name as the previous one) will overwrite the original file.

Writing to CD media may take time

Writing to a CD-R/RW will generally be slower than writing to a hard disk. The time it takes to write will depend on the speed of the CD-R/RW drive, and on the writing speed supported by the media.

Reading NAUTILUS CDs on other devices

CD-R media

You can read native NAUTILUS CDs, in UDF packet-writing format, on computers with packet-writing software installed.

For maximum compatibility, you can convert CD-Rs (not CD-RWs) into ISO9660. This makes it possible for the data to be read by other Korg devices that support the ISO9660 format, or by computers which do not have packet writing software. For more information, see “Convert to ISO9660 Format” on page 728.

Note: This conversion adds ISO9660 session data, which consumes approximately 20 MB of space.

CD-RW media

CD-RW disks cannot be converted into ISO9660 format, and so they can only be read by devices or computers which support UDF and packet-writing.

Korg devices which support ISO9660 format (level 1)

- KRONOS, OASYS, M3, TRITON, TRITON pro, TRITON proX, TRITON-Rack (*1)

- D1600, D12, D16, D1200mkII, D1600mkII, D16XD, D32XD

*1: Only the first session can be read.

Korg devices which support UDF version 1.5

- KRONOS, OASYS, M3, TRITON STUDIO, TRITON Extreme

Divided files

If data has to be read or processed while writing to a CD-R/RW, the resulting files may not be contiguous on the disk. Operations which can cause this include:

- Copying files larger than 1.9 MB from another CD-R/RW (or other media with a slow access speed)
- Using the **Rate Convert** (MEDIA– Utility page), **Save to Standard MIDI File** (MEDIA– Save page), or similar commands to save directly to a CD-R/RW

If a disk in this state is converted into ISO9660 format, it will be in the divided file format supported by ISO9660 level 3.

- ⚠ Such disks cannot be read by devices that do not support ISO9660 level 3, such as the original TRITON line and some older computer operating systems. These disks can be read on newer computer operating systems, as long as you can install software which supports ISO9660 level 3 or packet writing.

Troubleshooting converted CD-Rs

- ⚠ If your computer is unable to read a CD-R converted to ISO 9660 format, you may be able to read it using the following methods.

Disable packet writing (UDF) software

You may be unable to read the data if packet writing software is installed on your computer. If so, temporarily disable that software or uninstall it.

Notice: Use of GPL and LGPL software

The NAUTILUS uses the Linux kernel and some GNU utilities. This software is licensed by its copyright holder according to the GNU GPL (General Public License).

The Korg NAUTILUS software contained in this product is dynamically linked with some software libraries subject to the LGPL (Lesser GPL) license.

Copies of the GPL and LGPL licenses, as well as the source code for the software covered under those licenses, are provided on the website.

The complete list of software covered under the GPL, LGPL, and other free or open-source licenses which are used in the NAUTILUS, including the above software, is included in the same folder.

- These files are provided in accordance with the spirit of free software, and are not required in order to use this product.
- You cannot access these files directly from the NAUTILUS. To read them, you will need to use a separate computer running Windows, MacOS, Linux, or any other operating system capable of reading standard text files and tar, gzip, and bzip2 archives.

The Korg NAUTILUS software is copyright Korg Inc., and is independent of Linux. Its use is covered by the Korg NAUTILUS Software License, described elsewhere in the documentation. The GPL license does not apply to this software, and its source code is not provided.

Korg accepts no responsibility for any direct or consequential damages that may occur due to the use of or the inability to use any of the system software including the above software.

Linux is a trademark or registered trademark of Linus Torvalds in the United States and in other countries.

Updating the system

1. Downloading the system update

The most recent system update can be downloaded to a computer from the Korg website (<http://www.korg.com/NAUTILUS>). For more details, see the instructions on the website.

2. Updating the system

 Before you start the update process, back up important data on external USB storage media.

1. Using a computer, download the update from the Korg website: www.korg.com/NAUTILUS.

The update will be in compressed, zip format.

2. Un-zip the downloaded file.

Un-zipping will result in a main folder containing several different files and at least one sub-folder.

3. Follow any instructions included with the update.

4. Open the folder containing the update files and sub-folders.

5. From within this folder, copy the update files and sub-folder(s) to the root level of a FAT32-formatted USB storage device, such as a USB flash drive.

 Copy the files and sub-folders only; don't copy the main, enclosing folder.

 FAT32 format is required. Other formats, including NTFS (Windows) or HFS+ (Mac OS X), will not work. Most USB flash drives use FAT32 by default.

6. Disconnect all USB devices from the NAUTILUS.

Other USB devices may interfere with the update process.

7. Go to the GLOBAL > Basic Setup page.

To go to this page from any part of the system, press the GLOBAL button to enter GLOBAL mode, and press the EXIT switch up to four times.

8. Open the menu, and select the command "Update System Software."

A prompt will appear on the screen, instructing you to connect the USB storage device which contains the update file.

9. Connect the USB storage device containing the update file(s), from step 5 above.

10. Press the OK button.

A message and progress bar will appear on the screen, noting that the system is being updated.

 Do not disconnect the USB storage device while the update is in progress.

 While the system is being updated, do not touch the NAUTILUS' buttons, and never turn off the power. If the power is accidentally turned off while the system is being loaded, the NAUTILUS may become inoperable. If this occurs, using the Restore DVDs may be required; please contact your local Korg distributor.

When the update is complete, a new message will appear:

"Update to NAUTILUS system version [nn] complete. Please turn off the power, wait a moment, and then turn on power again to use the new software."

11. Turn off the NAUTILUS, and then disconnect the USB storage device.

12. Wait approximately ten seconds, and then turn the power on again.

The system version number is shown on the startup screen, and also on the GLOBAL > Options Info– System page. Verify that it is correct.

Restoring the system and factory sounds

If for some reason the NAUTILUS will not start up normally, or some other problem occurs, you can use the recovery disc to return the NAUTILUS to its factory-preset state.

Note: You will need a commercially-available external USB-connected DVD drive. Download the recovery disk image file from the Korg website, and burn the image to commercially-available DVD-R media from your computer.

Important - save your data before proceeding!

All of the Restore functions will erase all of the Programs, Combis, Drum Kits, Wave Sequences, Set Lists, Global settings, and other user data in the internal memory. Some of the functions will also erase data from the FACTORY directory on the hard drive, or even erase the hard drive entirely, as detailed below.

If you have any data that you want to keep—including data stored on the hard drive as well as data in the internal memory—we strongly recommend that you save it to a CD-R/RW disk, or to external USB media, before proceeding. For instance, use the Save All or Save .PCG commands to save the contents of the internal memory.

Contents of the Recovery Discs

Accessory Discs 1 and 2

This disc is only for use by the restore functionality, and do not include any user-readable data.

Accessory Disc 3

This is the only disc with user-readable data, as described below. In addition to the data used for the restore functionality, it contains the following:

- **FACTORY directory:** This contains original factory sounds, including Programs, Combinations, Wave Sequences, Drum Kits, Set Lists, Global Settings, etc. These are used by the Restore feature, but you can also load them directly in MEDIA mode.
- **licenses directory:** This contains the Korg NAUTILUS software license, in both English and Japanese, along with the open-source GPL and LGPL licenses (in English).
- **src directory:** This contains the source code applicable to the GPL and LGPL licenses.
- **manuals directory:** This contains various NAUTILUS documentation, including the Operation Guide and Parameter Guide, the Voice Name List (VNL), and so on.
- **MIDI Implementation**
- **Catalog**
- **Mac directory:** This contains NAUTILUS external setups, the Korg USB MIDI driver installer, and the Software Licensing Agreement.
- **Windows directory:** This contains NAUTILUS external setups, the Korg USB MIDI driver installer, and the Software Licensing Agreement.

NOTE: Only the FACTORY directory can be used directly on the NAUTILUS. All of the files in the other directories can only be read from a computer.

Restoring the NAUTILUS factory data

You can use the Restore function to restore the factory sounds (Programs, Combis, etc.), to initialize the internal memory, or to restore the operating system to its original state. These three options will not alter any user data stored on the disk, as long as it is not stored in the FACTORY folder.

If absolutely necessary, you can also re-format the entire internal hard disk, and then restore the operating system and factory sounds. This will destroy all user data on the internal hard disk, and may require re-authorization of the NAUTILUS before it can be used again—so be careful!

To use the Restore function:

1. **Disconnect all external USB devices from the NAUTILUS, except for a DVD drive.**

 External USB devices other than the DVD drive may interfere with the restoration process.

2. **Insert Accessory Disc 1 into a connected USB DVD drive.**

3. **Turn off the NAUTILUS. Wait for about ten seconds, and then power-on again.**

 Be sure to wait for about ten seconds before you turn on the power.

4. **A dialog box will appear. Use the +, – buttons, the VALUE dial to choose one of the following options:**

1. Format and Full Install
2. Full Install
3. Install Factory Sounds
4. Initialize Memory

See below for complete descriptions of each option.

If the disk is not formatted properly for the NAUTILUS, then the above menu is not shown. Instead, the following message will be displayed:

“The disk is not formatted for the NAUTILUS”

In this case, the only option offered is to perform a format and full install.

5. **Press the ENTER button to carry out the selected Restore function, or press EXIT to stop the process without altering any data.**

After pressing ENTER, an “Are you sure?” message will appear. If you are sure you want to proceed, press the ENTER button again. You can also cancel, without altering any data, by pressing the EXIT button.

6. **After pressing ENTER, the restore program will start up. Follow the instructions that appear in the screen.**

You’ll be asked to insert different DVD discs, depending on the option you chose in step 4. When a disc is requested, insert the appropriate disc, and then press the ENTER button. The entire process may take some time.

 Do not touch the front-panel controls or turn off the power while the Restore is underway, except for pressing ENTER and EXIT as prompted by the on-screen instructions.

7. **When the restore operation is complete, the following message will appear:**

Installation Completed!

Please remove installation media and power down the system.

If an error occurs, you'll see an error message instead. In this case, start again at step 3.

1. Format and Full Install

This option completely erases the internal hard drive, and then restores the operating system, the factory sounds and settings, and the demo songs, as described under "2. Full Install," below.

IMPORTANT: Normally, you should not need to do this—and you should **avoid using this function if at all possible**. Always try using the **Full Install** option first.

However, if for some reason the internal hard disk has been completely corrupted, and using **Full Install** does not fix the problem, this will allow you to restore the hard drive to its initial state.

IMPORTANT: after using this function, you may need to re-authorize the NAUTILUS, as described below. If this is required, you'll see a message at startup titled "Re-authorization required." Follow the instructions below to re-authorize. You will not be able to use the NAUTILUS until the re-authorization is complete.

2. Full Install

If for some reason the NAUTILUS will no longer start up normally, try this option first. It does the following:

- Restores the system software on the internal hard drive.
- Initializes the internal memory, and re-loads the original factory preload data—including all Programs, Combinations, Drum Kits, Wave Sequences, and Global settings.
- Erases all files inside the internal hard drive's **FACTORY** directory, and then restores the factory preload files, including the **PRELOAD.PCG** file and the demo sequences.

3. Install factory sounds

This option restores the factory sounds, settings, and demos in memory and on disk, as described under "2. Full Install," above.

Unlike **Full Install**, however, this option does not replace the operating system.

4. Initialize Memory

This option erases all of the Programs, Combinations, Drum Kits, Wave Sequences, and other data in the internal memory, leaving only blank data. The factory preload data is not restored.

Unlike the other three options, **Initialize Memory** does not affect the data stored on disk in any way.

Re-authorizing NAUTILUS

NAUTILUS uses a Digital Rights Management system to protect its proprietary components. After formatting the internal hard drive, you may see the following message at startup:

Re-authorization required

Please write down the Public ID shown below, and then go to <https://shop.korg.com/NAUTILUS/Register> (If you cannot access the internet, please contact your local Korg dealer or distributor.)

After registering the NAUTILUS, follow the website instructions to get the reauthorization file, and copy it to a USB device.

Insert USB device and press <ENTER>

Public ID: nn nn nn nn nn nn nn nn (where nn are characters 0-9 and a-f)

To re-authorize the system:

1. After using the "Format and Full Install" function, turn off the NAUTILUS.

At start-up, the LCD display will show a "Public ID." This is a unique identifier, like a very specific name; it is different for each and every NAUTILUS.

2. Write down the Public ID shown at the bottom of the screen. Make sure that you've copied it accurately.

The Public ID is 16 characters long, and uses only the characters 0-9 and a-f.

3. Turn off the power.

You'll need to complete the re-authorization process before using NAUTILUS any further.

4. Go to <http://www.korg.com/NAUTILUS/>, and follow the instructions to download the re-authorization file.

or:

If you do not have internet access, please contact your Korg dealer or distributor.

When contacting your Korg dealer or distributor, let them know that you need to re-authorize your NAUTILUS, and give them the Public ID that you wrote down in step 2.

You can find contact information for all Korg distributors, world-wide, on the Korg website:

<http://www.korg.co.jp/English/index.html>

Once you have the re-authorization file, either via download or from your Korg dealer or distributor:

5. Copy the file to the root level of a USB storage device.

Don't put it inside a folder or directory.

6. Turn on the NAUTILUS, and wait for the "Re-authorization required" screen to appear.

7. Connect the USB device to the NAUTILUS.

8. Press ENTER.

The system will search for the re-authorization file on the USB device. When the file is located, the last line of the screen will show the following message:

Re-authorization file found. Press <ENTER> to install.

If a valid re-authorization file is not located, the following message will be shown instead:

Re-authorization file not found. Press <ENTER> to continue.

If this message appears, make sure that the file is on the root directory of the USB device, and that its name has not been changed (it should be 14 characters long, followed by the suffix ".reauth"). Once you've double-checked the file name and location, try again starting at step 6.

9. Press ENTER to start the reauthorization.

When the re-authorization is complete, the last line of the screen will change to the following message:

Re-authorization successful! Please turn off power, wait, and turn on again.

10. Turn off the power, wait 10 seconds, and then turn on the power again.

Your NAUTILUS will now be re-authorized and ready to use.

IMPORTANT NOTICE TO CONSUMERS

This product has been manufactured according to strict specifications and voltage requirements that are applicable in the country in which it is intended that this product should be used. If you have purchased this product via the internet, through mail order, and/or via a telephone sale, you must verify that this product is intended to be used in the country in which you reside.

WARNING: Use of this product in any country other than that for which it is intended could be dangerous and could invalidate the manufacturer's or distributor's warranty.

Please also retain your receipt as proof of purchase otherwise your product may be disqualified from the manufacturer's or distributor's warranty.

KORG INC.

4015-2 Yanokuchi, Inagi-City, Tokyo 206-0812 JAPAN

© 2020 KORG INC.

<http://www.korg.com>

Published 11/2020